

User Manual

Revision 1.002
English

DeviceNet Slave / Modbus Master - Converter

(Order Code: HD67141-A1 – HD67141-B2)

for Website information:

www.adfweb.com?Product=HD67141

for Price information:

www.adfweb.com?Price=HD67141-A1

www.adfweb.com?Price=HD67141-B2

Benefits and Main Features:

- ▶ Very easy to configure
- ▶ Low cost
- ▶ Rail mountable
- ▶ Wide supply input range
- ▶ Galvanic isolation between two buses
- ▶ Industrial temperature range:
-40°C / 85°C (-40°F / 185°F)



HD67141-A1



HD67141-B2

For other DeviceNet products see also the following link:

DeviceNet Slave from/to

- www.adfweb.com?Product=HD67043
- www.adfweb.com?Product=HD67058
- www.adfweb.com?Product=HD67134
- www.adfweb.com?Product=HD67136
- www.adfweb.com?Product=HD67137
- www.adfweb.com?Product=HD67138
- www.adfweb.com?Product=HD67139
- www.adfweb.com?Product=HD67140
- www.adfweb.com?Product=HD67235
- www.adfweb.com?Product=HD67574

- (Ethernet)
- (M-Bus)
- (CANopen SDO Client)
- (CANopen SDO Server)
- (J1939)
- (Modbus Slave)
- (Modbus TCP Client)
- (Modbus TCP Server)
- (CAN)
- (PROFIBUS)

DeviceNet Master from/to

- www.adfweb.com?Product=HD67151
- www.adfweb.com?Product=HD67152
- www.adfweb.com?Product=HD67153
- www.adfweb.com?Product=HD67154
- www.adfweb.com?Product=HD67555

- (Modbus Slave)
- (Modbus TCP Server)
- (CANopen)
- (Ethernet)
- (PROFIBUS)

For other Modbus products see also the following link:

Modbus Master from/to

- www.adfweb.com?Product=HD67001
- www.adfweb.com?Product=HD67012

- (CANopen)
- (CAN)

Modbus Slave from/to

- www.adfweb.com?Product=HD67002
- www.adfweb.com?Product=HD67011

- (CANopen)
- (CAN)

INDEX:

	Page
INDEX	2
UPDATED DOCUMENTATION	2
REVISION LIST	2
WARNING	2
TRADEMARKS	2
SECURITY ALERT	3
CONNECTION SCHEME	4
CHARACTERISTICS	6
CONFIGURATION	6
POWER SUPPLY	7
FUNCTION MODES	8
LEDS	9
RS485	10
DEVICENET	11
RS232	12
USE OF COMPOSITOR SW67141	13
NEW PROJECT / OPEN PROJECT	13
SET COMMUNICATION	14
SET ACCESS	16
UPDATE DEVICE	18
MECHANICAL DIMENSIONS	20
ORDERING INFORMATIONS	21
ACCESSORIES	21
DISCLAIMER	22
OTHER REGULATIONS AND STANDARDS	22
WARRANTIES AND TECHNICAL SUPPORT	23
RETURN POLICY	23
PRODUCTS AND RELATED DOCUMENTS	23

UPDATED DOCUMENTATION:

Dear customer, we thank you for your attention and we remind you that you need to check that the following document is:

- Updated
- Related to the product you own.

To obtain the most recently updated document, note the "document code" that appears at the top right-hand corner of each page of this document.

With this "Document Code" go to web page www.adfweb.com/download/ and search for the corresponding code on the page. Click on the proper "Document Code" and download the update.

To obtain the updated documentation for the product that you own, note the "Document Code" (Abbreviated written "Doc. Code" on the label on the product) and download the updated from our web site www.adfweb.com/download/

REVISION LIST:

Revision	Date	Author	Chapter	Description
1.000	16/04/2010	Fl	All	First release version
1.001	25/10/2011	Fl	All	Revision
1.002	13/02/2013	Nt	All	Added new chapters

WARNING:

ADFweb.com reserves the right to change information in this manual about our product without warning.

ADFweb.com is not responsible for any error this manual may contain.

TRADEMARKS:

All trademarks mentioned in this document belong to their respective owners.

SECURITY ALERT:**GENERAL INFORMATION**

To ensure safe operation, the device must be operated according to the instructions in the manual. When using the device are required for each individual application, legal and safety regulation. The same applies also when using accessories.

INTENDED USE

Machines and systems must be designed so the faulty conditions do not lead to a dangerous situation for the operator (i.e. independent limit switches, mechanical interlocks, etc.).

QUALIFIED PERSONNEL

The device can be used only by qualified personnel, strictly in accordance with the specifications.

Qualified personnel are persons who are familiar with the installation, assembly, commissioning and operation of this equipment and who have appropriate qualifications for their job.

RESIDUAL RISKS

The device is state of the art and is safe. The instrument can represent a potential hazard if they are inappropriately installed and operated by personnel untrained. These instructions refer to residual risks with the following symbol:

 This symbol indicates that non-observance of the safety instructions is danger for people to serious injury or death and / or the possibility of damage.

CE CONFORMITY

The declaration is made by us. You can send an email to support@adfweb.com or give us a call if you need it.

CONNECTION SCHEME:

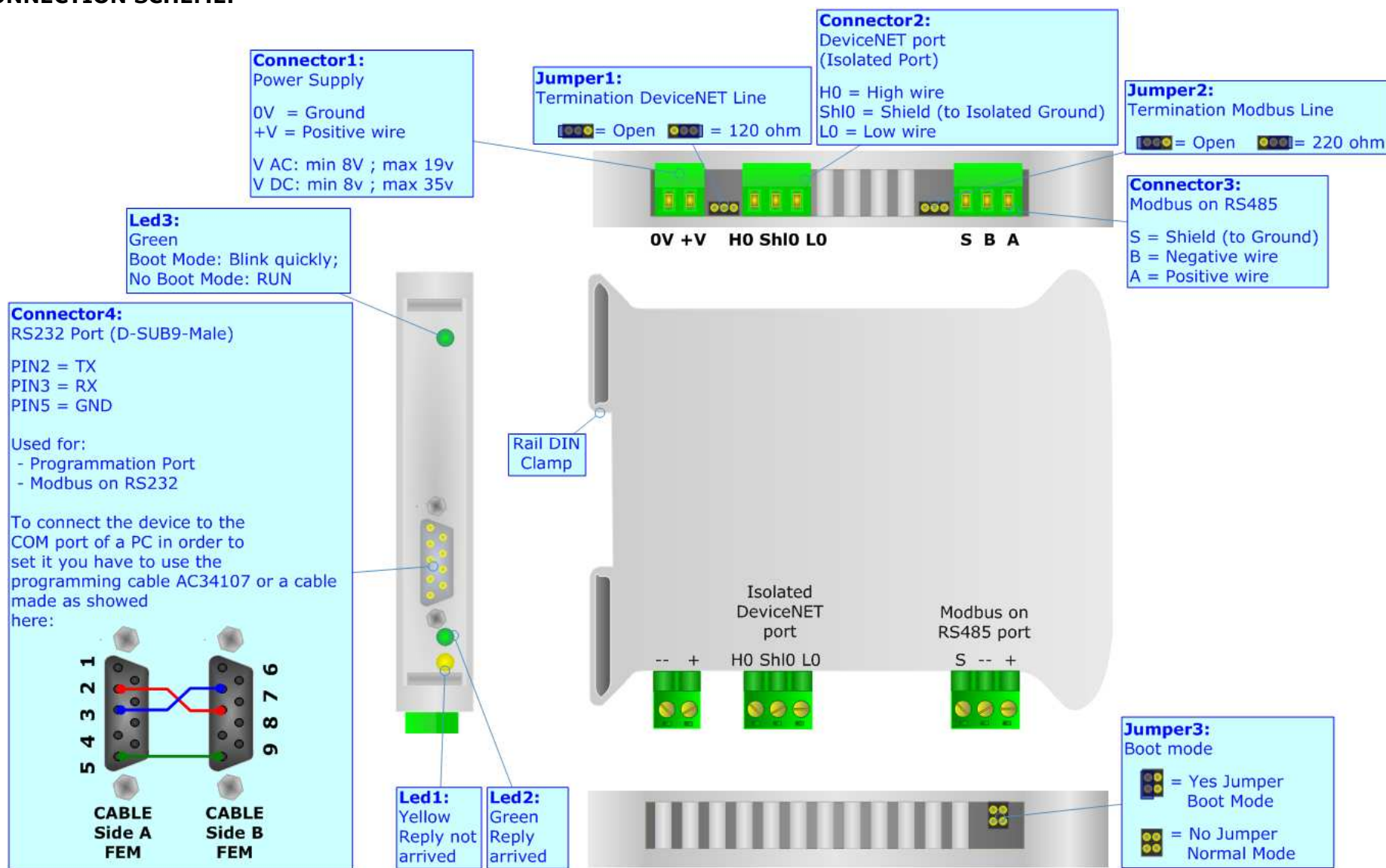

Figure 1: Connection scheme for HD67141-A1

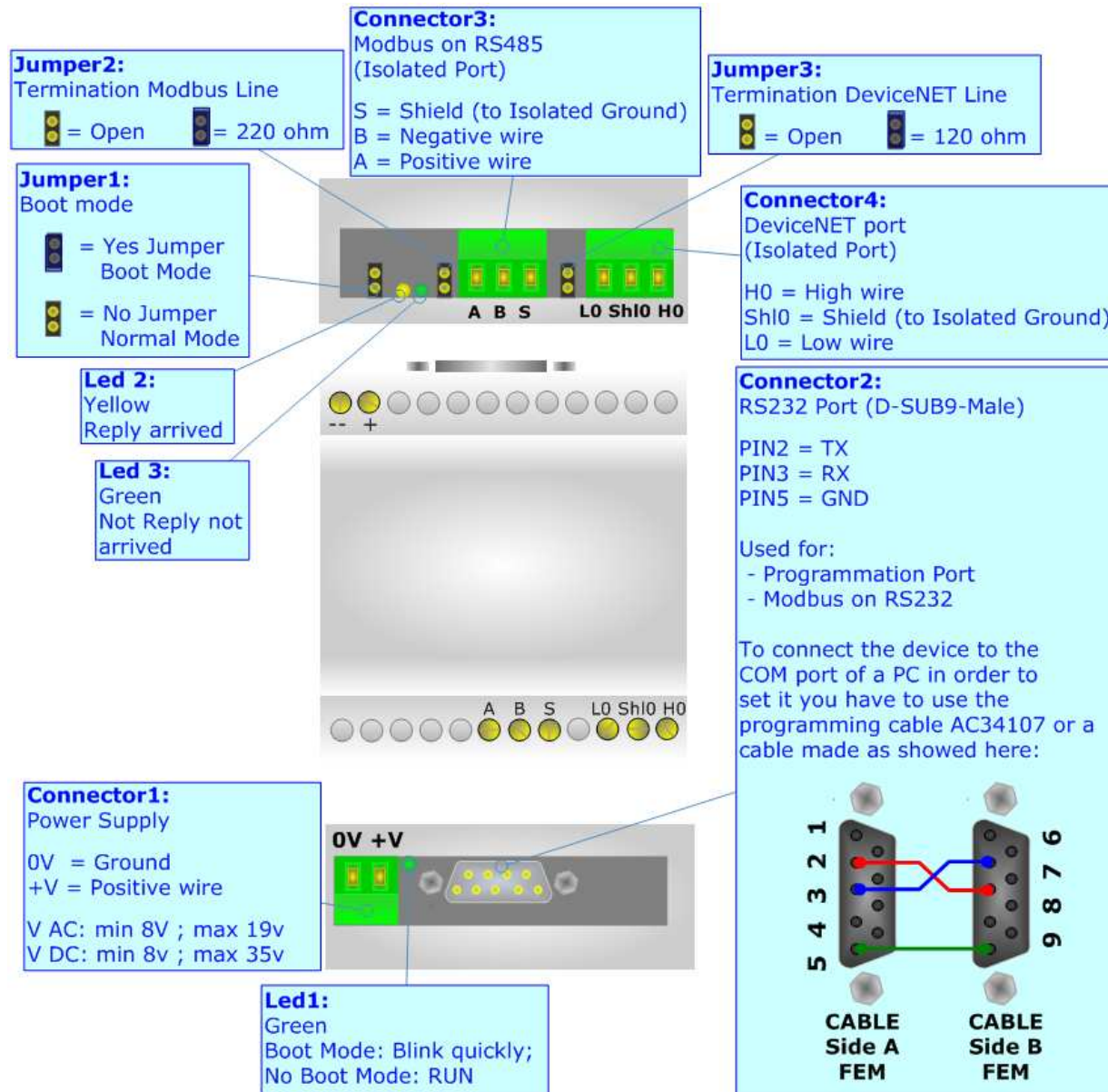

Figure 2: Connection scheme for HD67141-B2

CHARACTERISTICS:

The "DeviceNet Slave / Modbus Master - Converter" allows the following characteristics:

- Up to 455 bytes in reading and 455 bytes in writing on DeviceNet side;
- Two-directional information between Modbus and DeviceNet bus;
- Electrical isolation between two buses;
- Power supply of 8...19 V AC 4VA or 8...35 V DC 4W;
- 35mm Rail DIN mounting;
- Temperature range -40°C to 85°C.

CONFIGURATION:

You need Compositor SW67141 software on your PC in order to perform the following:

- Define the parameters of Modbus;
- Define the parameters of DeviceNet;
- Define the read/write registers;
- Update the Firmware and/or the Project.

POWER SUPPLY:

The devices can be powered between a wide range of tensions. For more details see the two tables below.

	VAC		VDC	
	Vmin	Vmax	Vmin	Vmax
HD67141-A1	8V	19V	8V	35V
HD67141-B2	8V	19V	8V	35V

Consumption at 24V DC:

Device	W/VA
HD67141-A1	4
HD67141-B2	4



Caution: Not reverse the polarity power

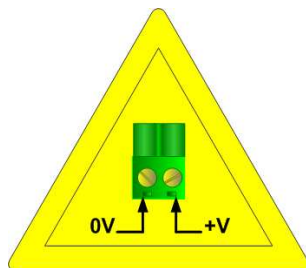

HD67141-A1

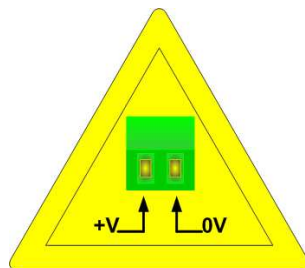

HD67141-B2

Connector1:
Power Supply
0V = Ground
+V = Positive wire
V AC: min 8V ; max 19v
V DC: min 8v ; max 35v



0V +V



+V 0V

Connector1:
Power Supply
0V = Ground
+V = Positive wire
V AC: min 8V ; max 19v
V DC: min 8v ; max 35v

FUNCTION MODES:

The device has got two functions mode depending of the position of the 'Jumper3' of HD67141-A1 or 'Jumper1' of HD67141-B2:

- The first, without any jumper inserted, is used for the normal working of the device.
- The second, with the jumper inserted, is used for upload the Project.

For the operations to follow for the updating (see 'UPDATE DEVICE' section).

According to the functioning mode, the LEDs will have specifics functions (see 'LEDS' section).

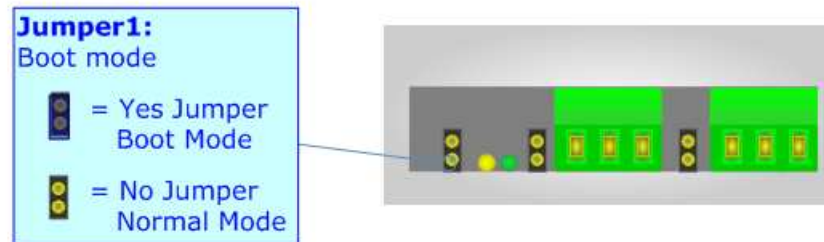
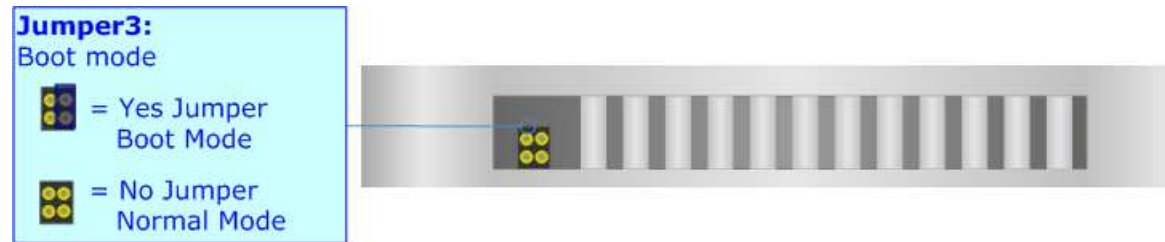

LEDS:

The device has got three LEDs that are used to give information of the functioning status. The various meanings of the LEDs are described in the table below.

LED	Normal Mode	Boot Mode
1: Device State	Blinks slowly (~1Hz)	Blinks quickly
2: Reply arrived	Changes his state when a Slave Modbus has replied to the gateway request	Off
3: Reply not arrived	Changes his state when a Slave Modbus hasn't replied to the gateway request	Off



RS485:

For terminate the CAN line with a 220Ω resistor it is necessary to insert the 'Jumper2' like in figure.

The maximum length of the cable should be 1200m (4000 feet).

Here some codes of cables:

- Belden: p/n 8132 - 2x 28AWG stranded twisted pairs conductor + foil shield + braid shield;
- Belden p/n 82842 - 2x 24AWG stranded twisted pairs conductor + foil shield + braid shield;
- Tasker: p/n C521 - 1x 24AWG twisted pair conductor + foil shield + braid shield;
- Tasker: p/n C522 - 2x 24AWG twisted pairs conductor + foil shield + braid shield.

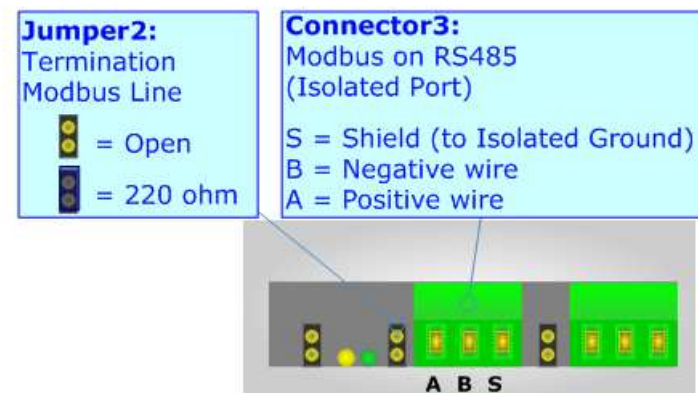
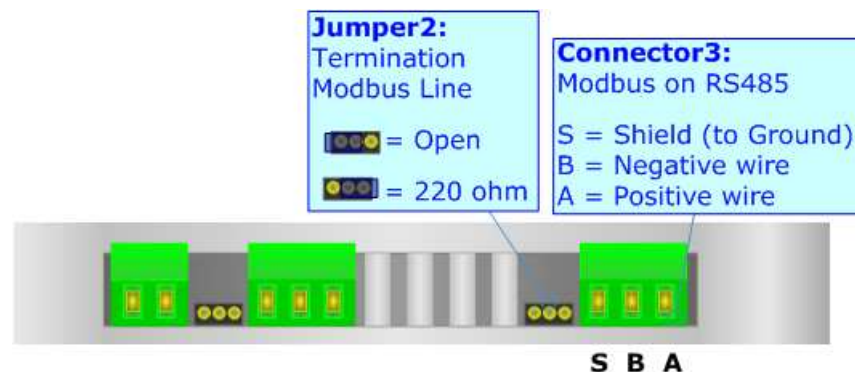

DEVICENET:

The connection from CAN socket must be made with a cable with these characteristics:

DC parameter:	Impedance	70 Ohm/m
AC parameters:	Impedance	120 Ohm/m
	Delay	5 ns/m
Length	Baud Rate [bps]	Length MAX [m]
	125 K	500
	250 K	250
	500 K	100

For terminate the CAN line with a 120Ω resistor it is necessary to insert the 'Jumper3' like in figure.

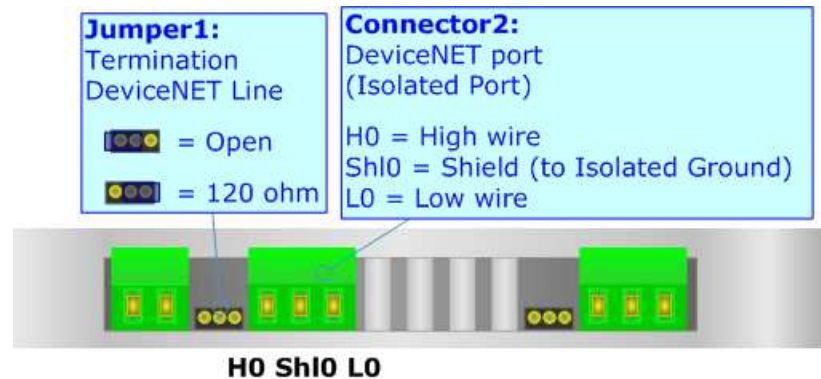

RS232:

The connection from RS232 socket to a serial port (example one from a personal computer), must be made with a Null Modem cable (a serial cable where the pins 2 and 3 are crossed). It is recommended that the RS232C Cable not exceed 15 meters.

The serial port is used for programming the device or for Modbus communication.

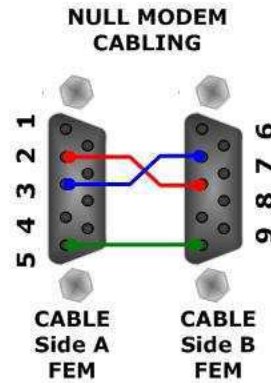

USE OF COMPOSITOR SW67141:

To configure the Gateway, use the available software that runs with Windows, called SW67141. It is downloadable on the site www.adfweb.com and its operation is described in this document.

When launching the SW67141 the right window appears (Fig. 3).

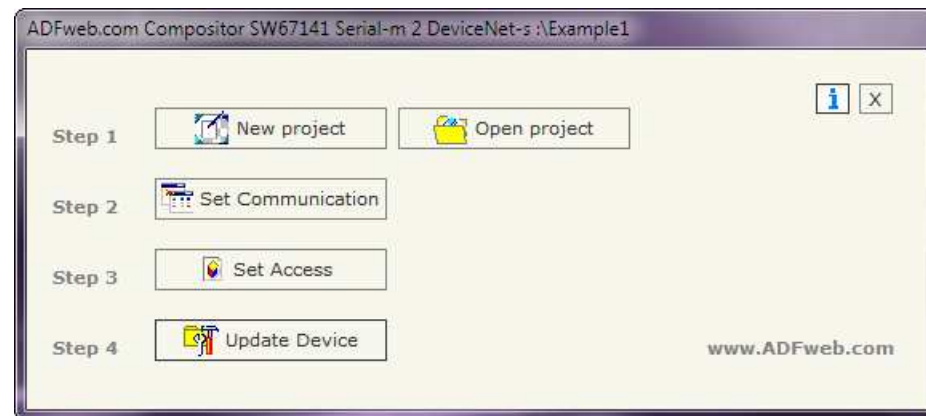
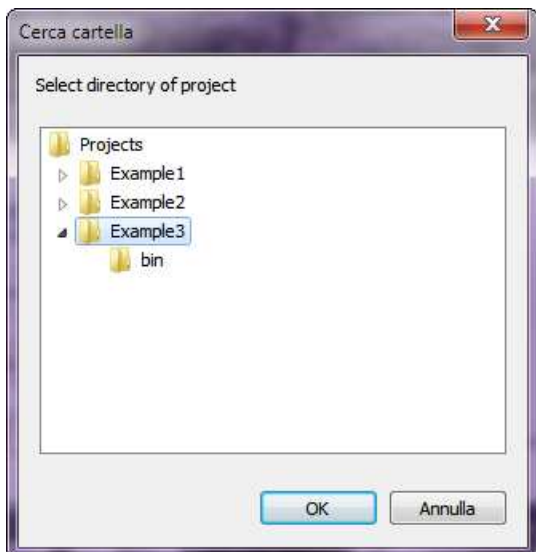

Figure 3: Main window for SW67141

NEW PROJECT / OPEN PROJECT:

The **"New Project"** button creates the folder which contains the entire device configuration.



A device configuration can also be imported or exported:

- To clone the configurations of a Programmable Modbus Master to DeviceNet Slave Gateway in order to configure another device in the same manner, it is necessary to maintain the folder and all its contents;
- To clone a project in order to obtain a different version of the project, it is sufficient to duplicate the project folder with another name and open the new folder with the button **"Open Project"**.

SET COMMUNICATION:

This section defines the fundamental communication parameters of two Buses Modbus and DeviceNet.

By pressing the **"Set Communication"** button from the main window for SW67141 (Fig. 3) the "SET COMMUNICATION" window appears (Fig. 4).

This window is divided in two sections, one for the Modbus and the other for the DeviceNet.

The means of the fields for "Serial" are:

- If the field **"RS232"** is checked, the serial line in use is the RS232, otherwise if the field **"RS485"** is checked, the serial line in use is the RS485;
- In the field **"Baud Rate"** the baudrate for the serial line is defined;
- In the field **"Parity"** the parity of the serial line is defined;
- In the field **"TimeOut"** there is the maximum time that the device attends for the answer from the Slave interrogated;
- In the field **"Cyclic Delay"** the delay between two requests is defined;
- In the subsection **"Protocol"** it is possible to select the protocol that you wish to use between the following:
 - **"Modbus RTU"**;
 - **"Modbus ASCII"**;
 - **"JBUS"**;
 - Simple **"Binary"** Protocol;
 - Simple **"ASCII"** Protocol.
- If the field **"Write on Change Data"** is checked, the gateway sends the write requests over Modbus only if a data is changed on DeviceNet side, otherwise if the field **"Cyclic Write"** is checked, the gateway sends the write requests over Modbus even if a data isn't changed on DeviceNet side.

The screenshot shows the "SET COMMUNICATION" dialog box. It is organized into several sections. The "Serial" section at the top has radio buttons for "RS232" and "RS485", with "RS485" selected. Below are dropdown menus for "Baudrate" (115200) and "Parity" (NONE), and text input fields for "TimeOut" (1000) and "Cyclic Delay" (10). The "Protocol" section contains radio buttons for "Modbus RTU" (selected), "Modbus ASCII", "JBUS", "Binary", and "ASCII". The "Write" section has radio buttons for "Write on Change Data" (selected) and "Cyclic Write". The "DeviceNet" section includes an "ID Dev." field (2), a "Baud rate" dropdown (500K), and "N Byte IN" (455) and "N Byte OUT" (455) fields. At the bottom of the DeviceNet section is an "Error/Diagnosis Modbus" section with an unchecked checkbox "Enable check Modbus Error with cancellation of data", a "Number Continuous Error" field (3), and a "Value to set to data bytes" field (0x00). The dialog concludes with "OK" and "Cancel" buttons.

Figure 4: "Set Communication" window

The means of the fields for the "DeviceNet" section are:

- In the "**ID Dev.**" field the Gateway address of the DeviceNet is defined.
- In the "**Baud rate**" field the DeviceNet baud rate is defined;
- In the field "**Number Byte IN**" the number of byte from the DeviceNet to the gateway is defined (at maximum it is possible to use 455 byte);
- In the field "**Number Byte OUT**" the number of byte from the gateway to the DeviceNet is defined (at maximum it is possible to use 455 byte);
- If the field "**Enable check Modbus Error with cancellation of data**" is checked, when the gateway isn't able to write/read information to a Slave Modbus (defined in the "Set Access" section) consecutively for the times defined in the field "**Number Continuos Error**" puts the values of DeviceNet OUT at the value defined in the field "**Value to set to data bytes**".

SET ACCESS:

By pressing the "Set Access" button from the main window for SW67141 (Fig. 3) the window "Set Access" appears (Fig. 5).

This window is divided in two parts, the " DeviceNet IN --> Serial Write" and the " Serial Read --> DeviceNet OUT".

The first part ("DeviceNet OUT --> Serial Read") is used to read the data from the Modbus Line and make available such data to a DeviceNet master through the DeviceNet OUT.

The second part ("Serial Write --> DeviceNet IN") is used to write the data that arrive at Devicenet side (DeviceNet IN) into the defined Modbus registers.

DeviceNet OUT → Serial Read

The means of the fields are:

- ✦ In the field "Slave ID", the address for the Slave Modbus device to be read is defined;
- ✦ In the field "Type" insert the data type of the Register you like read.
 - Coil Status;
 - Input Status;
 - Holdind Register;
 - Input Register.
- ✦ In the field "Address Register" the start address of the register to be read is defined;
- ✦ In the field "NPoint" insert the number of consecutive register to be read;
- ✦ If the field "SWAP" is checked the data read is swapped;
- ✦ In the field "Address DeviceNet" the position where the data will be saved in the DeviceNet array is defined;
- ✦ In the field "Mnemonic" the description for the request is defined.

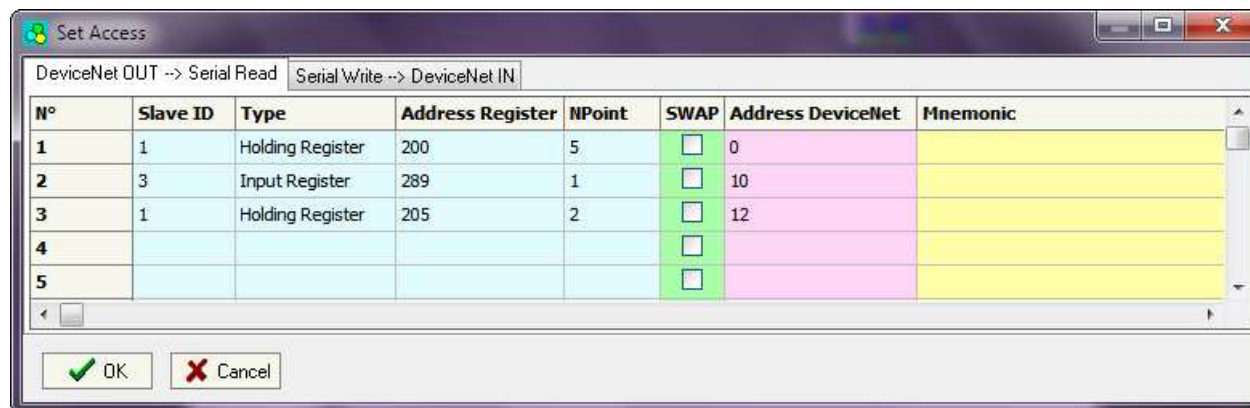

Figure 5: "Set Access" window

Serial Write → DeviceNet IN

The means of the fields are:

- ✚ In the field "**Slave ID**", the address for the Slave Modbus device to be write is defined;
- ✚ In the field "**Type**" insert the data type of the Register you like read.
 - Coil Status;
 - Holding Register.
- ✚ In the field "**Address Register**" the start address of the Register to be write is defined;
- ✚ In the field "**NPoint**" insert the number of consecutive register to be write;
- ✚ If the field "**SWAP**" is checked the data written is swapped;
- ✚ In the field "**Address DeviceNet**" the position where the data will be read from the DeviceNet array is defined;
- ✚ In the field "**Mnemonic**" the description for the request is defined.

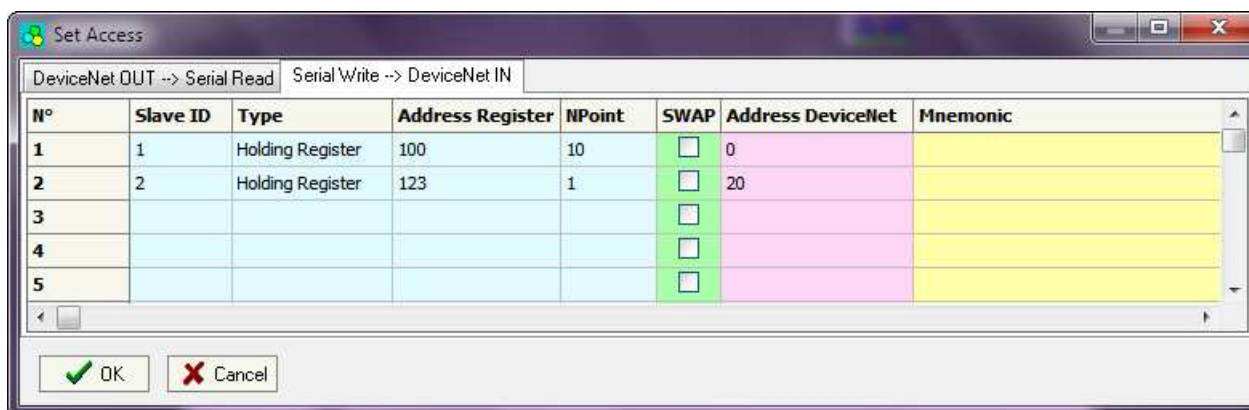

Figure 6: "Set Access" window

UPDATE DEVICE:

By pressing the **"Update Device"** button it is possible to load the created Configuration into the device; and also the Firmware, if is necessary.

In order to load the parameters or update the firmware in the device, follow these instructions:

- Turn off the Device;
- Connect the RS232 Null Modem Cable form your PC to the Gateway;
- Insert the Boot Jumper (For more info see Fig. 1 or Fig. 2);
- Select the **"COM port"** and press the **"Connect"** button;
- Turn on the device;
- Check the BOOT Led. It must blink quickly (see "LEDS" section);
- Press the **"Next"** button;
- Select which operations you want to do.
- Press the **"Execute update firmware"** button to start the upload;
- When all the operations are "OK" turn off the device;
- Disconnect the Boot jumper;
- Disconnect the RS232 Cable;
- Turn on the device.

At this point the configuration/firmware on the device is correctly update.

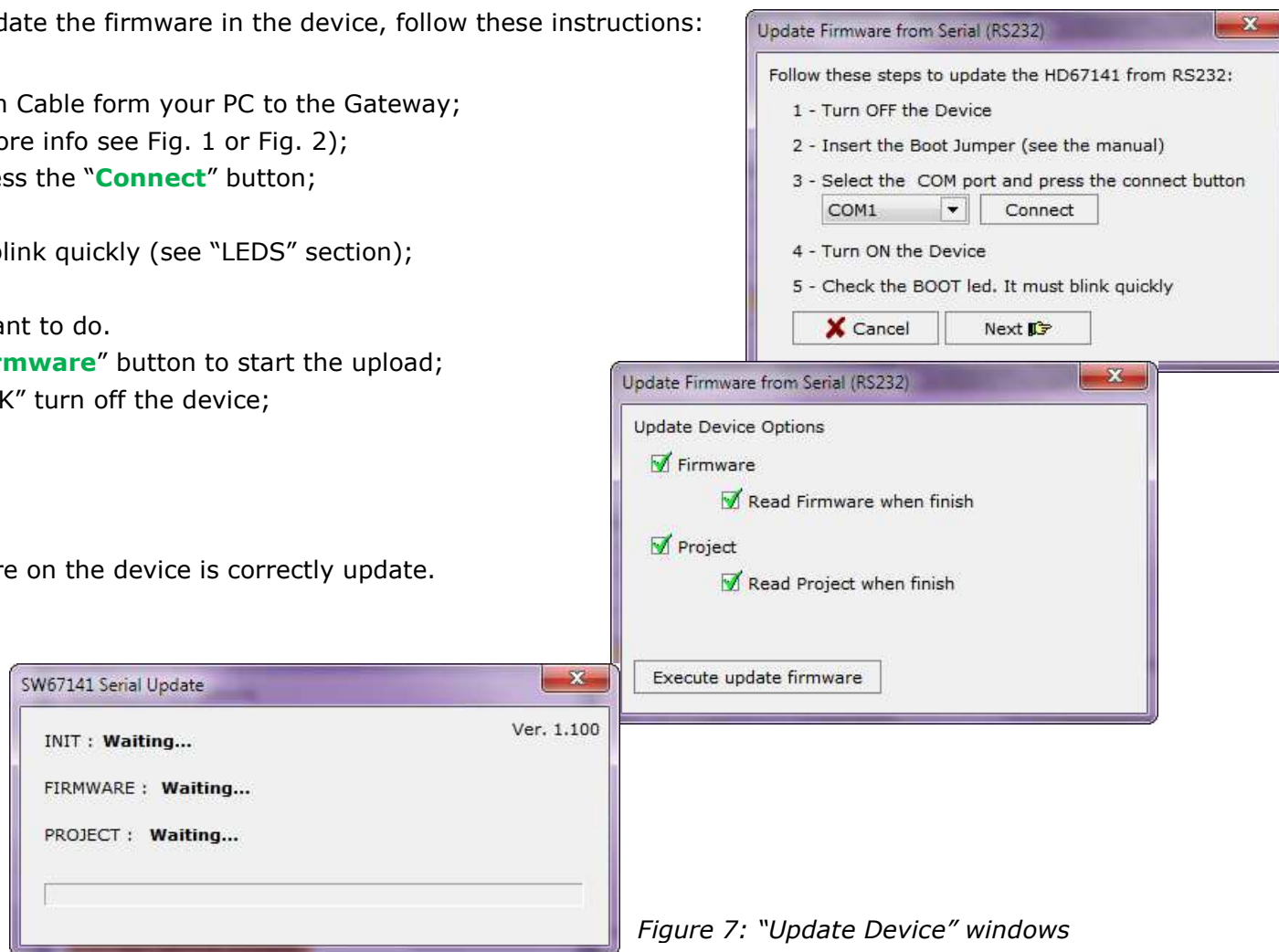

Figure 7: "Update Device" windows

**Note:**

When you install a new version of the software it is better if the first time you do the update of the Firmware in the HD67141-xx device.

**Warning:**

If the Fig. 8 appears when you try to do the Update before require assistance try these points:

- Check if the serial COM port selected is the correct one;
- Check if the serial is connected between the PC and the device;
- Try to repeat the operations for the updating;
- If you are using a dongle try with a native COM port or change the dongle;
- Try with another PC;
- Try to restart the PC;
- If you are using the program inside a Virtual Machine, try to use in the main Operating System.



Figure 8: "Protection" window



In the case of HD67141-A1 or HD67141-B2 you have to use the software "SW67141": www.adfweb.com/download/filefold/SW67141.zip.

MECHANICAL DIMENSIONS:

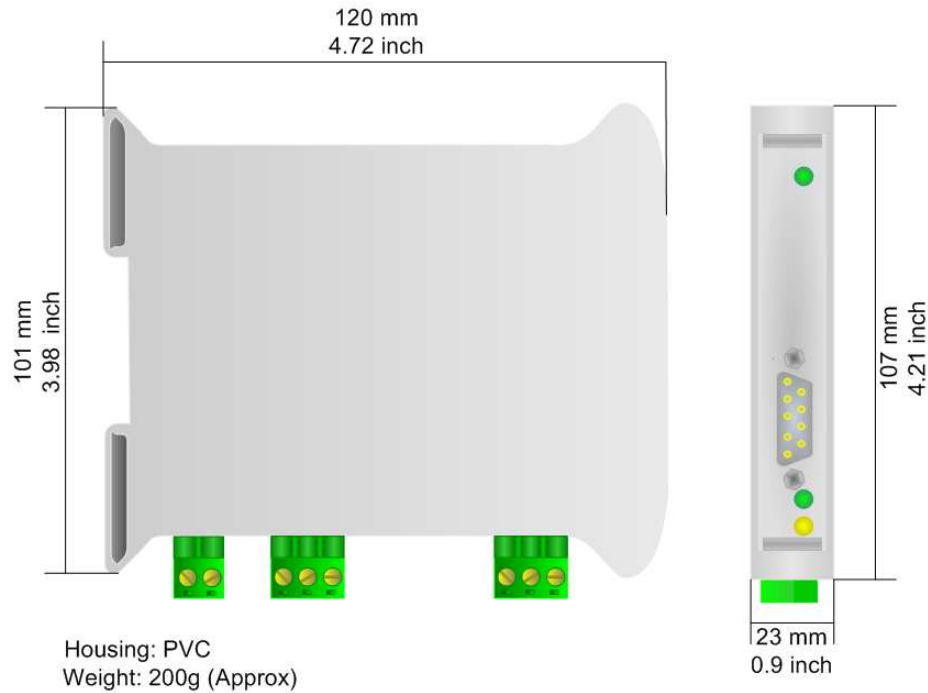

Figure 10: Mechanical dimensions scheme for HD67141-A1

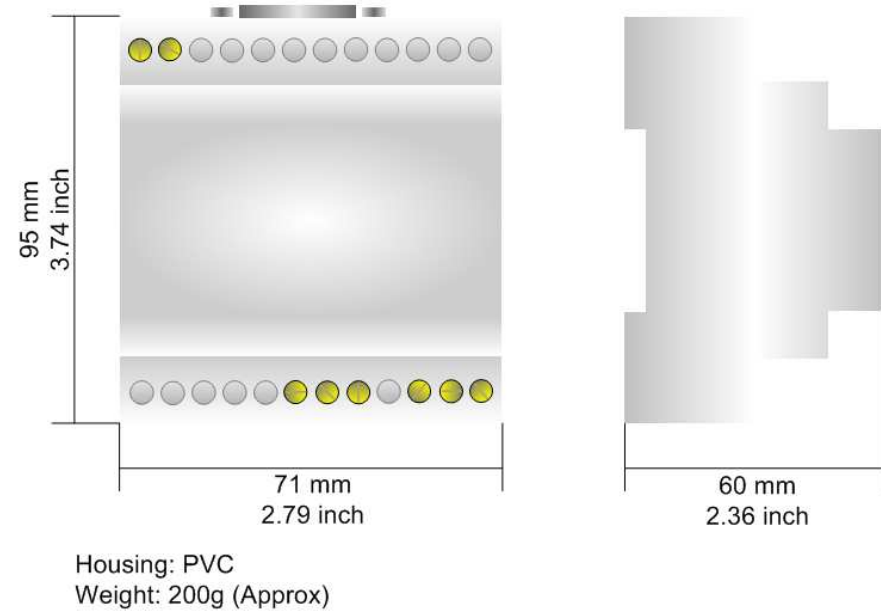
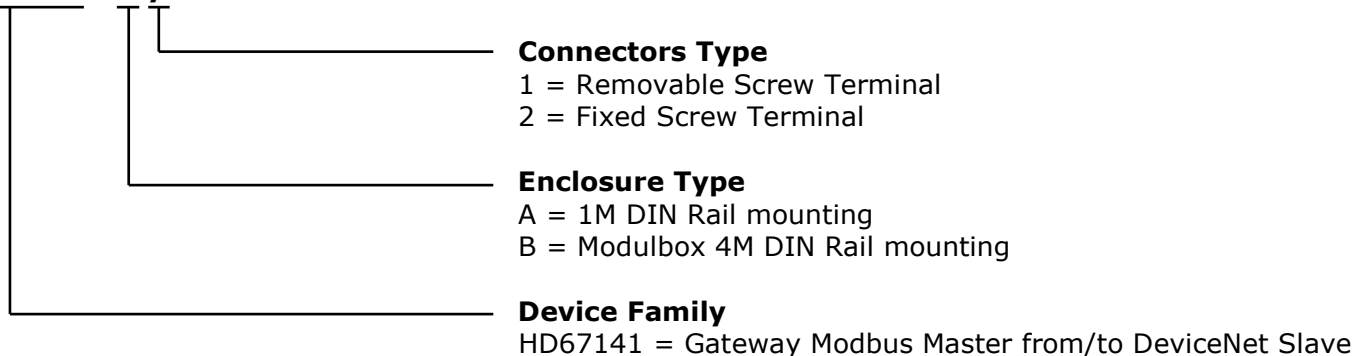

Figure 11: Mechanical dimensions scheme for HD67141-B2

ORDERING INFORMATIONS:

The ordering part number is formed by a valid combination of the following:

HD67141 - x y



Order Code: **HD67141-A1-** DeviceNet Slave / Modbus Master - Converter

Order Code: **HD67141-B2-** DeviceNet Slave / Modbus Master - Converter

ACCESSORIES:

Order Code: **AC34107** - Null Modem Cable Fem/Fem DSub 9 Pin 1,5 m

Order Code: **AC34114** - Null Modem Cable Fem/Fem DSub 9 Pin 5 m

DISCLAIMER

All technical content within this document can be modified without notice. The content of the document content is a recurring audit. For losses due to fire, earthquake, third party access or other accidents, or intentional or accidental abuse, misuse, or use under abnormal conditions repairs are charged to the user. ADFweb.com S.r.l. will not be liable for accidental loss of use or inability to use this product, such as loss of business income. ADFweb.com S.r.l. shall not be liable for consequences of improper use.

OTHER REGULATIONS AND STANDARDS

WEEE INFORMATION



Disposal of old electrical and electronic equipment (as in the European Union and other European countries with separate collection systems).

■ This symbol on the product or on its packaging indicates that this product may not be treated as household rubbish. Instead, it should be taken to an applicable collection point for the recycling of electrical and electronic equipment. If the product is disposed correctly, you will help prevent potential negative environmental factors and human health, which could otherwise be caused by inappropriate disposal. The recycling of materials will help to conserve natural resources. For more information about recycling this product, please contact your local city office, your household waste disposal service or the shop where you purchased the product.

RESTRICTION OF HAZARDOUS SUBSTANCES DIRECTIVE



The device respects the 2002/95/EC Directive on the restriction of the use of certain hazardous substances in electrical and electronic equipment (commonly referred to as Restriction of Hazardous Substances Directive or RoHS).

CE MARKING



The product conforms with the essential requirements of the applicable EC directives.



WARRANTIES AND TECHNICAL SUPPORT:

For fast and easy technical support for your ADFweb.com srl products, consult our internet support at www.adfweb.com. Otherwise contact us at the address support@adfweb.com.

RETURN POLICY:

If while using your product you have any problem and you wish to exchange or repair it, please do the following:

- 1) Obtain a Product Return Number (PRN) from our internet support at www.adfweb.com. Together with the request, you need to provide detailed information about the problem.
- 2) Send the product to the address provided with the PRN, having prepaid the shipping costs (shipment costs billed to us will not be accepted).
- 3) If the product is within the warranty of twelve months, it will be repaired or exchanged and returned within three weeks. If the product is no longer under warranty, you will receive a repair estimate.

PRODUCTS AND RELATED DOCUMENTS:

Part	Description	URL
HD67117	CAN Repeater/Isolator	www.adfweb.com?Product=HD67117
HD67316	Can Analyzer	www.adfweb.com?Product=HD67316
HD67221	Translate CAN bus Gateway	www.adfweb.com?Product=HD67221
HD67401	CAN Repeater/Isolator	www.adfweb.com?Product=HD67401