

# User Manual

Revision 2.002  
English

## PROFIBUS Master / Modbus Slave - Converter

( Order Code: HD67580-A1 )

for Website information:

[www.adfweb.com/?Product=HD67580](http://www.adfweb.com/?Product=HD67580)

for Price information:

[www.adfweb.com/?Price=HD67580-A1](http://www.adfweb.com/?Price=HD67580-A1)

### Benefits and Main Features:

- ✦ Very easy to configure
- ✦ Industrial temperature range:
- ✦ -40°C / 85°C (-40°F / 185°F)

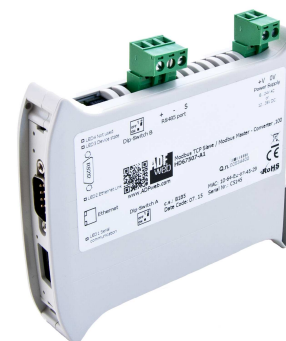

For others PROFIBUS devices, see also the following links:

#### PROFIBUS Slave from/to ...

- [www.adfweb.com?Product=HD67045](http://www.adfweb.com?Product=HD67045) (... Serial)
- [www.adfweb.com?Product=HD67053](http://www.adfweb.com?Product=HD67053) (... M-Bus Master)
- [www.adfweb.com?Product=HD67551](http://www.adfweb.com?Product=HD67551) (... CANopen)
- [www.adfweb.com?Product=HD67552](http://www.adfweb.com?Product=HD67552) (... CAN)
- [www.adfweb.com?Product=HD67553](http://www.adfweb.com?Product=HD67553) (... J1939)
- [www.adfweb.com?Product=HD67554](http://www.adfweb.com?Product=HD67554) (... DeviceNet Slave)
- [www.adfweb.com?Product=HD67555](http://www.adfweb.com?Product=HD67555) (... DeviceNet Master)
- [www.adfweb.com?Product=HD67561](http://www.adfweb.com?Product=HD67561) (... Modbus Master)
- [www.adfweb.com?Product=HD67562](http://www.adfweb.com?Product=HD67562) (... Modbus Slave)
- [www.adfweb.com?Product=HD67563](http://www.adfweb.com?Product=HD67563) (... Ethernet Server)
- [www.adfweb.com?Product=HD67564](http://www.adfweb.com?Product=HD67564) (... Modbus TCP Client)
- [www.adfweb.com?Product=HD67565](http://www.adfweb.com?Product=HD67565) (... Modbus TCP Server)

#### PROFIBUS Master from/to ...

- [www.adfweb.com?Product=HD67575](http://www.adfweb.com?Product=HD67575) (... Ethernet)
- [www.adfweb.com?Product=HD67577](http://www.adfweb.com?Product=HD67577) (... CAN)
- [www.adfweb.com?Product=HD67579](http://www.adfweb.com?Product=HD67579) (... Modbus TCP Slave)

Do you have an your customer protocol?

See the following links:

[www.adfweb.com?Product=HD67003](http://www.adfweb.com?Product=HD67003)

Do you need to choose a device? do you want help?

Ask it to the following link:

[www.adfweb.com?Cmd=helpme](http://www.adfweb.com?Cmd=helpme)



User Manual

**INDEX:**

	Page
INDEX	2
UPDATED DOCUMENTATION	2
REVISION LIST	2
WARNING	2
TRADEMARKS	2
SECURITY ALERT	3
EXAMPLE OF CONNECTION	4
CONNECTION SCHEME	5
CHARACTERISTICS	6
CONFIGURATION	6
POWER SUPPLY	7
FUNCTION MODES	8
LEDS	9
PROFIBUS	10
ETHERNET	10
RS485	11
USE OF COMPOSITOR SW67580	12
NEW PROJECT / OPEN PROJECT	13
SOFTWARE OPTIONS	14
SET COMMUNICATION	15
PROFIBUS NETWORK	16
MASTER PROFIBUS OPTIONS	17
PROFIBUS DEVICE	18
UPDATE DEVICE	26
MODBUS MAP	28
MECHANICAL DIMENSIONS	30
ORDER CODE	31
ACCESSORIES	31
DISCLAIMER	32
OTHER REGULATIONS AND STANDARDS	32
WARRANTIES AND TECHNICAL SUPPORT	33
RETURN POLICY	33

**UPDATED DOCUMENTATION:**

Dear customer, we thank you for your attention and we remind you that you need to check that the following document is:

- Updated
- Related to the product you own

To obtain the most recently updated document, note the “document code” that appears at the top right-hand corner of each page of this document.

With this “Document Code” go to web page [www.adfweb.com/download/](http://www.adfweb.com/download/) and search for the corresponding code on the page. Click on the proper “Document Code” and download the updates.

**REVISION LIST:**

Revision	Date	Author	Chapter	Description
1.000	28/11/2011	Fl	All	First release version
2.000	22/08/2012	Fl	All	Software changed (v1.300)
2.001	09/01/2013	Nt	All	Added new chapters
2.002	14/04/2017	Ff	All	Revision

**WARNING:**

ADFweb.com reserves the right to change information in this manual about our product without warning.

ADFweb.com is not responsible for any error this manual may contain.

**TRADEMARKS:**

All trademarks mentioned in this document belong to their respective owners.

**SECURITY ALERT:****GENERAL INFORMATION**

To ensure safe operation, the device must be operated according to the instructions in the manual. When using the device, legal and safety regulation are required for each individual application. The same applies also when using accessories.

**INTENDED USE**

Machines and systems must be designed so the faulty conditions do not lead to a dangerous situation for the operator (i.e. independent limit switches, mechanical interlocks, etc.).

**QUALIFIED PERSONNEL**

The device can be used only by qualified personnel, strictly in accordance with the specifications.

Qualified personnel are persons who are familiar with the installation, assembly, commissioning and operation of this equipment and who have appropriate qualifications for their job.

**RESIDUAL RISKS**

The device is state-of-the-art and is safe. The instruments can represent a potential hazard if they are inappropriately installed and operated by untrained personnel. These instructions refer to residual risks with the following symbol:



This symbol indicates that non-observance of the safety instructions is a danger for people that could lead to serious injury or death and / or the possibility of damage.

**CE CONFORMITY**

The declaration is made by our company. You can send an email to [support@adfweb.com](mailto:support@adfweb.com) or give us a call if you need it.

**EXAMPLE OF CONNECTION:**

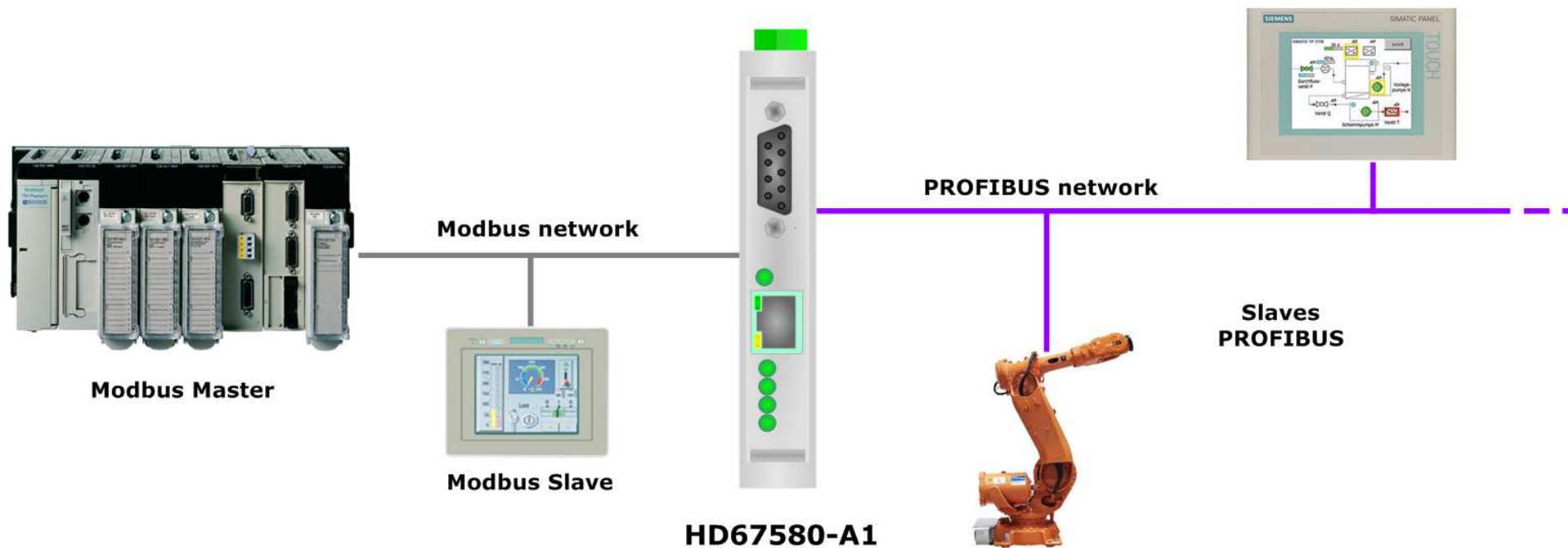

**CONNECTION SCHEME:**

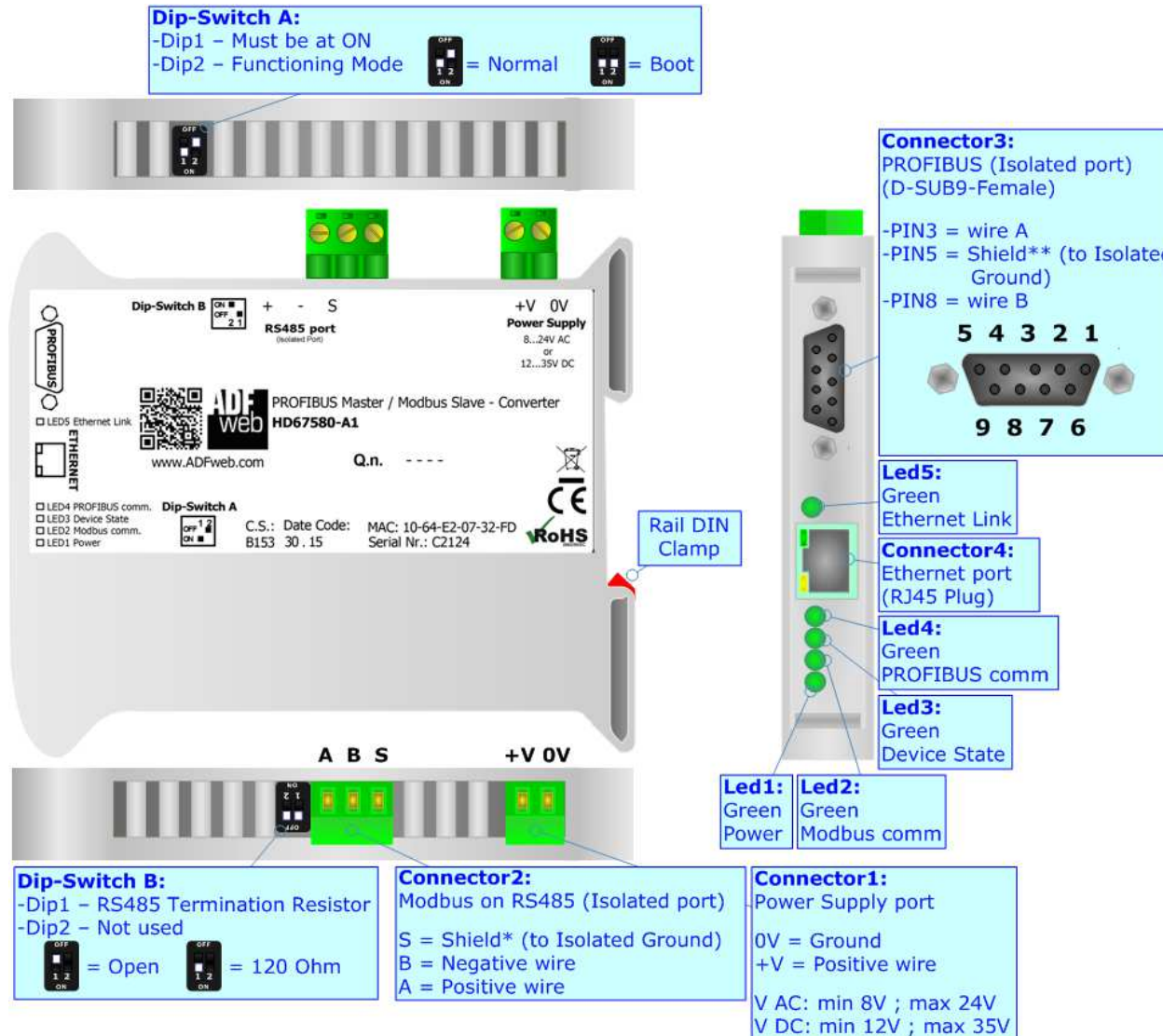

Figure 1: Connection scheme for HD67580-A1

**CHARACTERISTICS:**

The configurable "PROFIBUS Master / Modbus Slave - Converter" allows the following characteristics:

- Triple isolation between Modbus/PROFIBUS, Modbus/Power Supply, PROFIBUS/Power Supply.
- Mountable on 35mm Rail DIN;
- Power Supply 8...24V AC or 12...35V DC;
- Temperature range -40°C to 85°C.

**CONFIGURATION:**

You need Compositor SW67580 software on your PC in order to perform the following:

- Define the parameter of the PROFIBUS;
- Define the parameter of the Modbus line;
- Define the PROFIBUS network.

**POWER SUPPLY:**

The devices can be powered between a wide range of tensions. For more details see the two tables below.

	VAC		VDC	
	Vmin	Vmax	Vmin	Vmax
<b>HD67580-A1</b>	<b>8V</b>	<b>24V</b>	<b>12V</b>	<b>35V</b>

Consumption at 24V DC:

Device	W/VA
HD67580-A1	4



**Caution: Not reverse the polarity power**

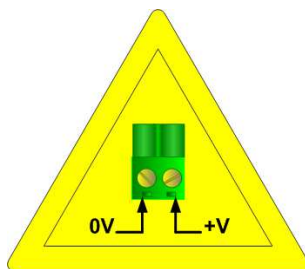

HD67580-A1

**Connector1:**  
 Power Supply port  
 0V = Ground  
 +V = Positive wire  
 V AC: min 8V ; max 24V  
 V DC: min 12V ; max 35V



**FUNCTION MODES:**

The device has got two functions mode depending of the position of the Dip2 of 'Dip-Switch A':

- The first, with Dip2 in Off position (factory setting), is used for the normal working of the device.
- The second, with Dip2 in On position, is used for upload the Project/Firmware.

For the operations to follow for the updating see 'UPDATE DEVICE' section.

According to the functioning mode, the LEDs will have specifics functions see 'LEDS' section.

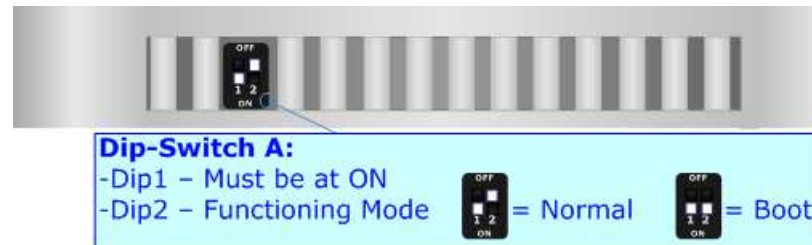

Note:

Dip1 of 'Dip-Switch A' must be at ON to work even if the Ethernet cable is not inserted.



**LEDS:**

The device has got five LEDs that are used to give information of the functioning status.  
The various meanings of the LEDs are described in the table below.

LED	Normal Mode	Boot Mode
1: Power (green)	<b>ON:</b> Powered <b>OFF:</b> Not powered	<b>ON:</b> Powered <b>OFF:</b> Not powered
2: Modbus comm (green)	Blinks quickly when receive Modbus frames	<b>Blinks quickly:</b> Boot state <b>Blinks very slowly (~0.5Hz):</b> update in progress
3: Device State (green)	Blinks slowly (~1Hz)	<b>Blinks quickly:</b> Boot state <b>Blinks very slowly (~0.5Hz):</b> update in progress
4: PROFIBUS comm (green)	Blinks quickly when there is PROFIBUS communication	<b>Blinks quickly:</b> Boot state <b>Blinks very slowly (~0.5Hz):</b> update in progress
5: Ethernet Link (green)	<b>ON:</b> Ethernet cable connected <b>OFF:</b> Ethernet cable disconnected	<b>ON:</b> Ethernet cable connected <b>OFF:</b> Ethernet cable disconnected

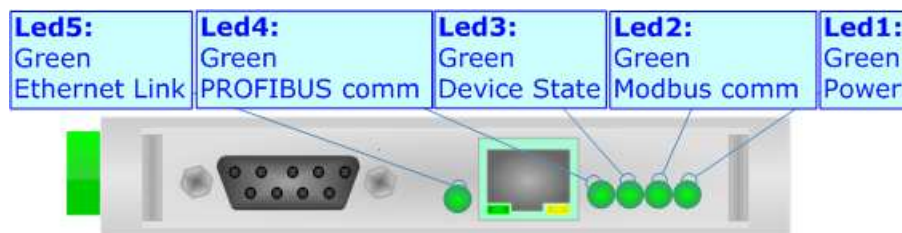

**PROFIBUS:**

The PROFIBUS uses a 9-pin D-SUB connector. The pin assignment is defined like in the right figure.

Here some codes of cables:

- Belden: p/n 183079A - Continuous Armor DataBus® ISA/SP-50 PROFIBUS Cable.

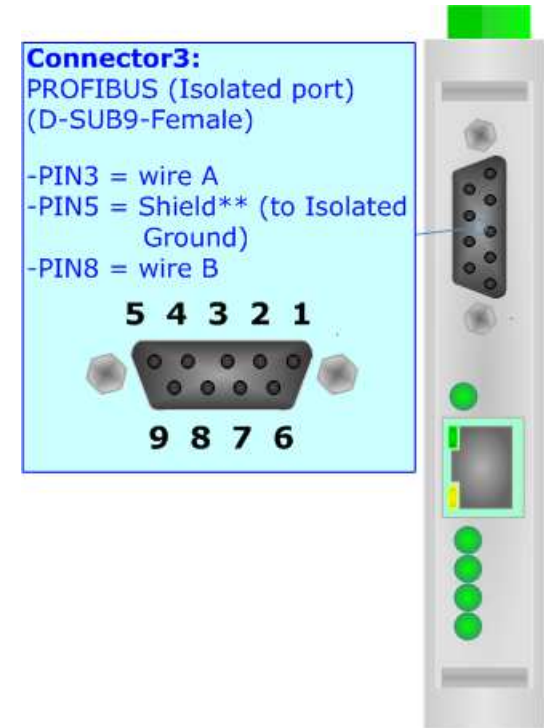

**ETHERNET:**

The Ethernet connection must be made using Connector3 of HD67580-A1 with at least a Category 5E cable. The maximum length of the cable should not exceed 100m. The cable has to conform to the T568 norms relative to connections in cat.5 up to 100 Mbps. To connect the device to an Hub/Switch is recommended the use of a straight cable, to connect the device to a PC/PLC/other is recommended the use of a cross cable.



**RS485:**

For terminate the RS485 line with a 120Ω resistor it is necessary that the Dip1 of Dip-Switch B is at ON position.

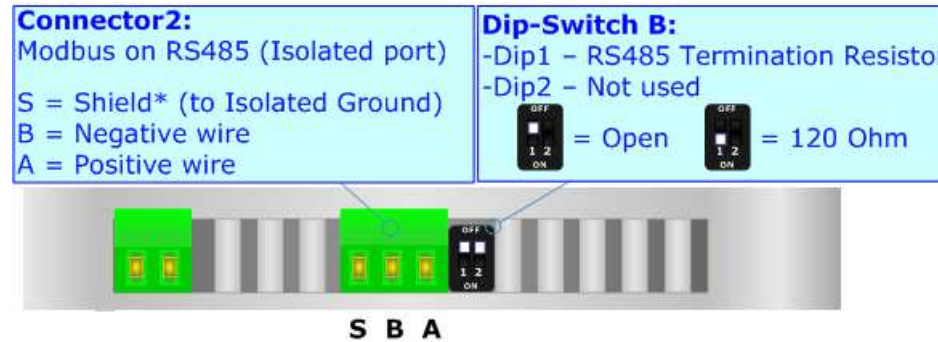

The maximum length of the cable should be 1200m (4000 feet).

Here some codes of cables:

- Belden: p/n 8132 - 2x 28AWG stranded twisted pairs conductor + foil shield + braid shield;
- Belden p/n 82842 - 2x 24AWG stranded twisted pairs conductor + foil shield + braid shield;
- Tasker: p/n C521 - 1x 24AWG twisted pair conductor + foil shield + braid shield;
- Tasker: p/n C522 - 2x 24AWG twisted pairs conductor + foil shield + braid shield.

**USE OF COMPOSITOR SW67580:**

To configure the Converter, use the available software that runs with Windows called SW67580. It is downloadable on the site [www.adfweb.com](http://www.adfweb.com) and its operation is described in this document. *(This manual is referenced to the last version of the software present on our web site).* The software works with MSWindows (XP, Vista, Seven, 8, 10; 32/64bit).

When launching the SW67580, the window below appears (Fig. 2).

 **Note:**  
It is necessary to have installed .Net Framework 4.

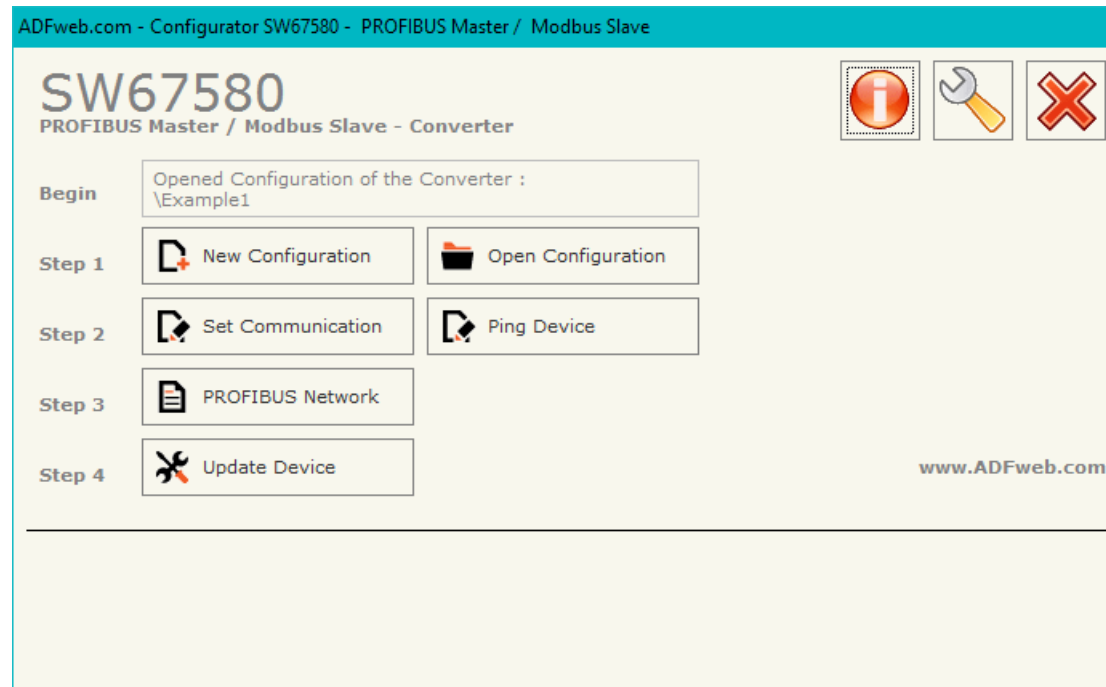
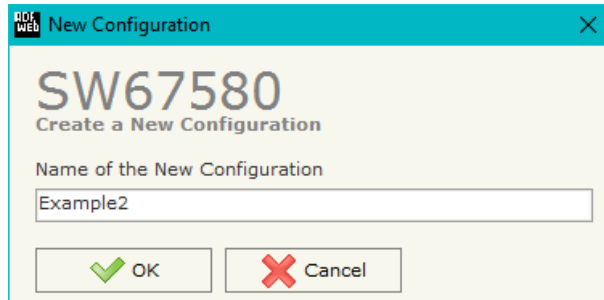

Figure 2: Main window for SW67580

**NEW CONFIGURATION / OPEN CONFIGURATION:**

The “**New Configuration**” button creates the folder which contains the entire device’s configuration.



A device’s configuration can also be imported or exported:

- To clone the configurations of a Programmable “PROFIBUS Master / Modbus Slave - Converter” in order to configure another device in the same manner, it is necessary to maintain the folder and all its contents;
- To clone a project in order to obtain a different version of the project, it is sufficient to duplicate the project folder with another name and open the new folder with the button “**Open Configuration**”.

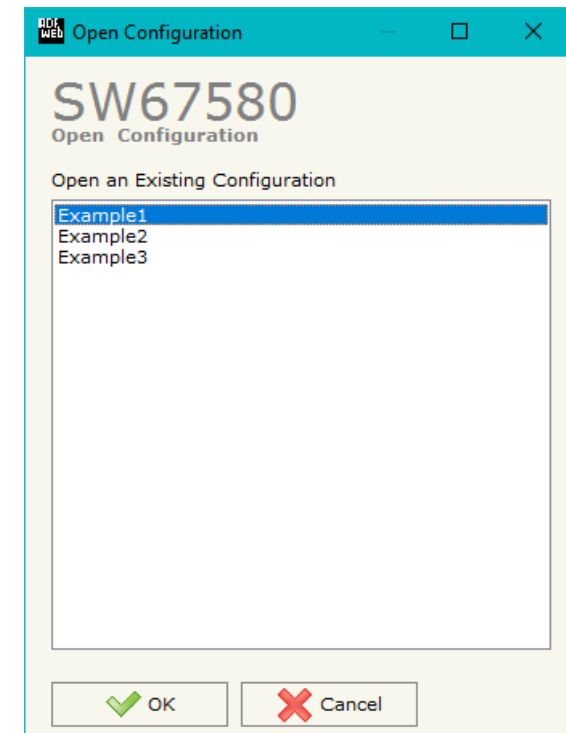

**SOFTWARE OPTIONS:**

By pressing the “**Settings**” () button there is the possibility to change the language of the software and check the updatings for the compositor.

In the section “Language” it is possible to change the language of the software.

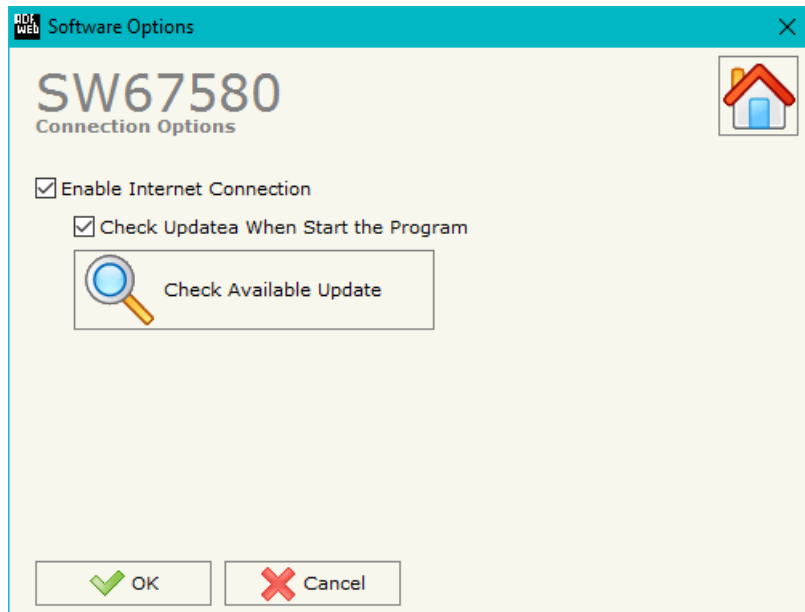

In the section “Connection Options”, it is possible to check if there are some updatings of the software compositor in ADFweb.com website. Checking the option “**Check Software Update at Start of Program**”, the SW67580 check automatically if there are updatings when it is launched.

## SET COMMUNICATION:

This section defines the fundamental communication parameter of two buses, PROFIBUS and Modbus. And also the parameter of the Ethernet port used for programming the device.

By pressing the **"Set Communication"** button from the main window for SW67580 (Fig. 2) the window "Set Communication" appears (Fig. 3).

The window is divided in three sections, one for the PROFIBUS, one for the Modbus and the other for Ethernet.

The means of the fields for "PROFIBUS" are:

- In the field **"ID Dev."** the address of the PROFIBUS side is defined;
- In the field **"Baud rate"** the baud rate for the PROFIBUS side is defined;

The means of the fields for "Modbus" are:

- In the field **"Baudrate"** the data rate of the serial line is defined;
- In the field **"Parity"** the parity of the serial line is defined;
- In the field **"Answer Delay"** the time (expressed in milliseconds) that the converter waits before sending the reply to the request is defined;
- If the field **"Read with Input Register / Status Function"** is checked, it is possible to read the Input bytes of PROFIBUS side with Input Registers (Function 04) and write the Output bytes of PROFIBUS side with Holding Registers (Function 06/16). The Output bytes are readable with Function 03. Otherwise, only Holding Registers will be used and the Output bytes of PROFIBUS side cannot be read back.

The means of the fields for "Ethernet (Program port)" are:

- In the field **"IP ADDRESS"** the IP address of the Converter for programming of it is defined;
- In the field **"SUBNET Mask"** the SubNet Mask of the network is defined.

SW67580  
Set Communication Setting

PROFIBUS

ID Dev. 1

Baudrate 6.0M

Modbus

Baudrate 115200

Parity None

Answer Delay 0

Read with Input Register / Status Function

Ethernet (Program Port)

IP ADDRESS

192 . 168 . 0 . 59

SUBNET Mask

255 . 255 . 255 . 0

OK Cancel

Figure 3: "Set Communication" window

**PROFIBUS NETWORK:**

By pressing the "**PROFIBUS Network**" button from the main window for SW67580 (Fig. 2) the window "PROFIBUS Network" (Fig. 4) appears.

In this window is possible to:

- Modify the PROFIBUS Master Options ("**Master PROFIBUS Options**");
- Add a PROFIBUS Slave in the Network of the Master ("**Add Slave PROFIBUS**");
- Modify a PROFIBUS Slave in the Network ("**Modify Slave PROFIBUS**");
- Remove a PROFIBUS Slave from the Network ("**Remove Slave PROFIBUS**").

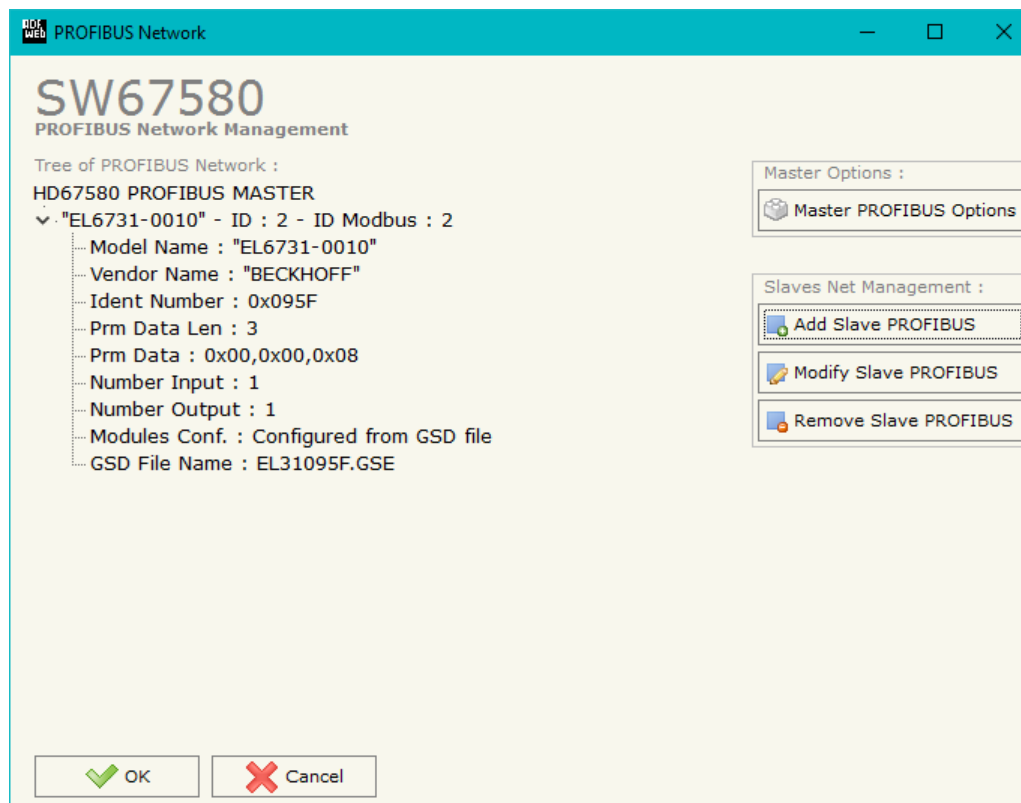

Figure 4: "PROFIBUS Network" window



**MASTER PROFIBUS OPTIONS:**

By pressing the “**Master PROFIBUS Options**” button from the “PROFIBUS Network” window (Fig. 4) the “PROFIBUS Master Options” window appears (Fig. 5).

In this window is possible to set the WatchDog Time for the PROFIBUS Slaves.

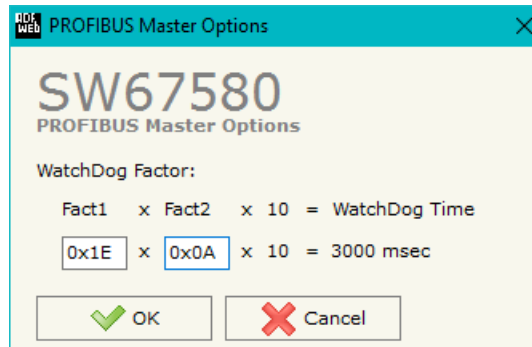

Figure 5: “PROFIBUS Master Options” window



**Note:**

Fact1 and Fact2 could be write in decimal o hexadecimal (with prefix “0x” or “\$”) and the values must be between 1 and 255



**Warning:**

The WatchDog time must be between 200 and 650250 milliseconds.

**PROFIBUS DEVICE:**

By pressing the "Add Slave PROFIBUS" and "Modify Slave PROFIBUS" button (or double click above an existent PROFIBUS Slave) from the "PROFIBUS Network" window (Fig. 4) the "PROFIBUS Device" window appears (Fig. 6).

In this window is possible to:

- Set the PROFIBUS Slave ID ("ID Slave PROFIBUS");
- Set the Modbus Slave ID ("ID Slave Modbus");
- Select the Modules present in the PROFIBUS Slave from the Available Modules in GSD file ("Module Selection");
- Modify the User Parameters (if present) of the PROFIBUS device ("User Parameters");
- Modify the Parameters (if present) of the Module Selected ("Module Parameters");
- Watch Features and Baudrate supported from the PROFIBUS device ("Capabilities");
- Select the Sync, Freeze and Reset of Data Options ("Options").

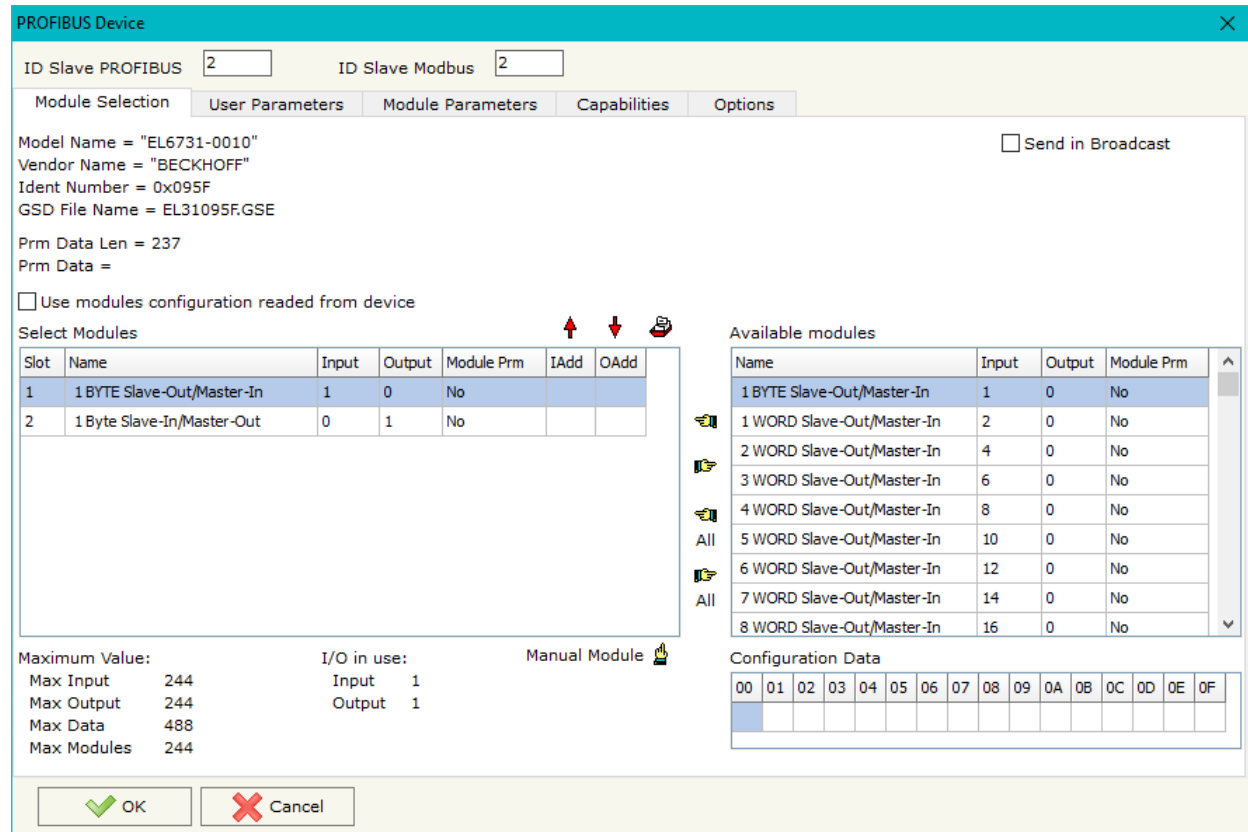

Figure 6: "PROFIBUS Device" window

**MODULE SELECTION:**

The section "Module Selection" is used to select which Modules are present in the Slave (Fig. 7).

In this section is possible to:

- Check the list of the Modules selected ("Select Modules") (Fig. 7, point (1)) and the list of Modules Available in GSD file ("Available Modules") (Fig. 7, point (7));
- Add a Module from the list of GSD file (Fig. 7, point (6));
- Remove a Module from selected list (Fig. 7, point (5));
- Add all Modules present in the GSD file (Fig. 7, point (4));
- Remove all Modules from selected list (Fig. 7, point (3));
- Insert a Module not present in the GSD file ("**Manual Module**") (Fig. 7 point (2)). For more info see the section "Manual Module" below;
- Enable the read of configuration directly from the PROFIBUS Slave ("**Use module configuration readed from device**") (Fig 7, point (8)). If this option is enable the configuration of the modules is discarded and the device read the correct configuration directly to the PROFIBUS slave.

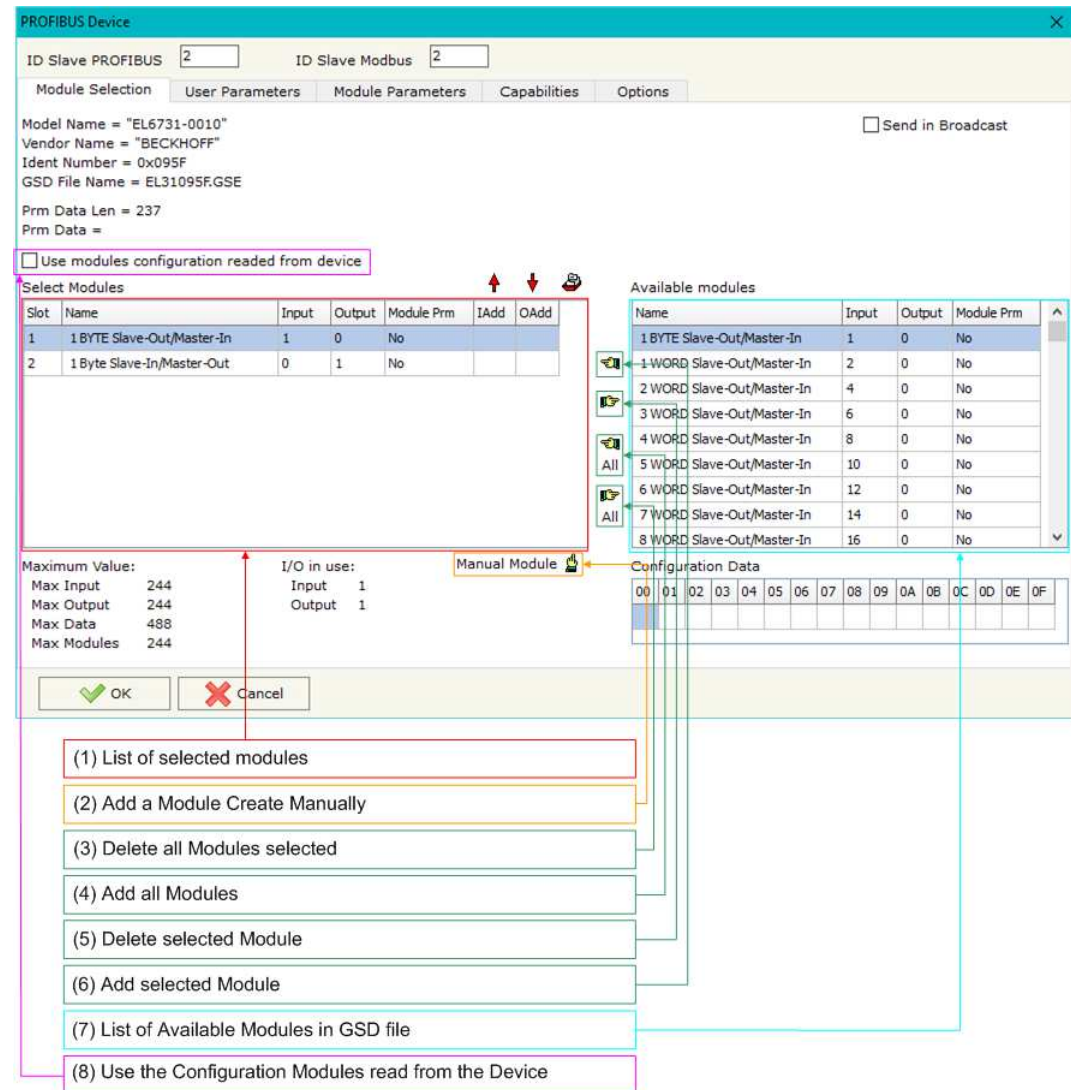

Figure 7: "PROFIBUS Device – Module Selection" window

By pressing the **Manual Module** button from the "PROFIBUS Device" window (Fig. 6) the "Add Module Manually" window appears (Fig. 8).

In this window is possible to add a Module manually, i.e. writing the configuration of the module (in hexadecimal).

	00	01	02	03	04	05	06	07	08	09	0A	0B	0C	0D	0E	0F
00																
10																

Figure 8: "Add/Modify Module Manually" window

The means of the fields are:

- In the field **Description of Module** a name of the Module is defined;
- In the field **Insert the Configuration of Module (HEX)** the configuration of the module is defined. The configuration must be write in hexadecimal mode (without prefix "0x" o "\$").

To modify a Module inserted manually, is necessary to do a double click on the module to change in the "Select Module" list (Fig. 7, point (1)). It is possible to change only the module inserted manually.



**Note:**

The Values inserted in the table must between 00 and FF

**USER PARAMETERS:**

The section "User Parameters" is used to modify the parameters of the PROFIBUS slave (Fig. 9).

In this section there are:

- The List of all Parameters available for the PROFIBUS device ("User Parameters") (Fig. 9, point (1));
- The Configuration of all parameters in RAW ("Parameters in RAW (Hex)") (Fig. 9, point(2));
- The "Use Parameter Inserted Manually", enable this option is possible to insert manually the parameters of Device and also of the Modules. Using the "Modify User Parameters Manually" button is possible to insert/modify the parametrization of the device (and/or modules). For more info see below. (Fig. 9, point(3));
- The admitted value for the selected parameter. It is possible to select the value desired and confirm it with the "Apply" button. If no value appears in this table, the "Min Value" and "Max Value" are the limit of the parameter. (Fig. 9, point(4));
- The "Apply" button is used to confirm the new value of the parameter, the "Default" button is used to load the factory value for the parameter. In "New Value" edit box it is possible to set the new value. (Fig. 9, point(5)).

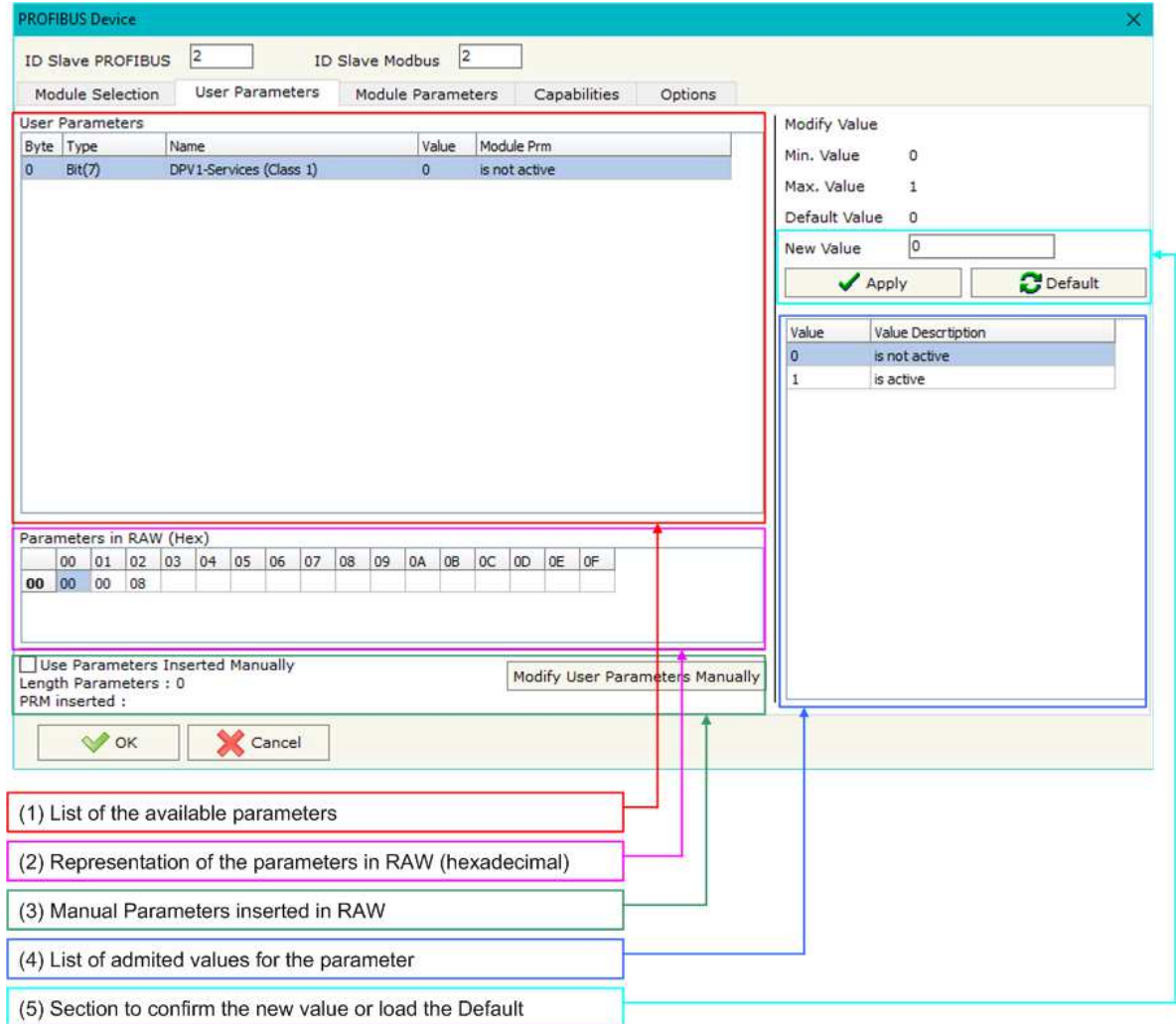

Figure 9: "PROFIBUS Device – User Parameters" window

By pressing the **“Modify User Parameters Manually”** button from the “PROFIBUS Device” window (Fig. 6) the “Add Module Manually” window appears (Fig. 10).

In this window is possible to add/modify the User and/or Modules Parameters manually, i.e. writing the configuration of the parameters (in hexadecimal).

The means of the fields are:

- In the field **“Insert the number of User Parameter”** the number of byte for the parameter have to be inserted;
- In the field **“Insert the Configuration of Module (HEX)”** the configuration of the User and/or Modules Parameters is defined. The configuration must be write in hexadecimal mode (without prefix “0x” o “\$”).



**Note:**

The Values inserted in the table must between 00 and FF

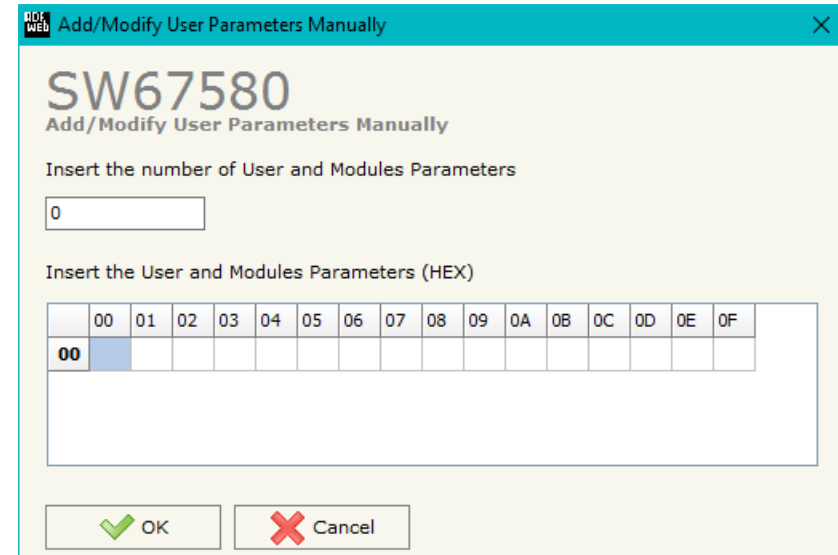

Figure 10: “Add/Modify User Parameters Manually” window

**MODULE PARAMETERS:**

The section "Module Parameters" is used to modify the parameters of the Modules (Fig. 11).

In this section there are:

- The List of all Module selected in the GSD file ("Available modules") (Fig. 11, point (1));
- The List of all Parameters available for the Module selected ("Parameters of module") (Fig. 11, point (2));
- The Configuration of all parameters in RAW for the Module selected ("Parameters in RAW (Hex)") (Fig. 11, point(3));
- The admitted value for the selected parameter. It is possible to select the value desired and confirm it with the "Apply" button. If no value appears in this table, the "Min Value" and "Max Value" are the limit of the parameter. (Fig. 11, point(4));
- The "Apply" button is used to confirm the new value of the parameter, the "Default" button is used to load the factory value for the parameter. In "New Value" edit box it is possible to set the new value. (Fig. 11, point(5));

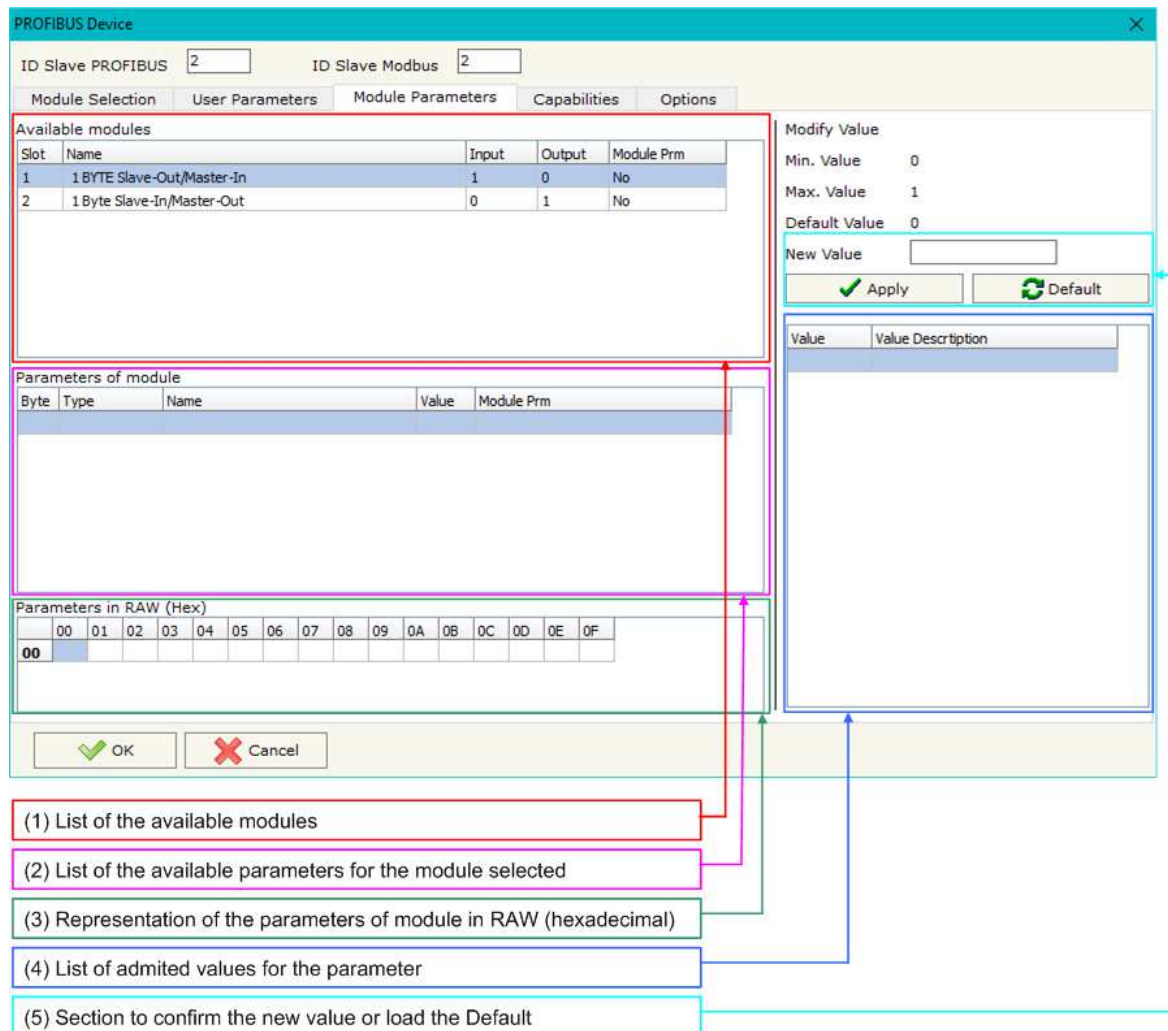

Figure 11: "PROFIBUS Device – Module Parameters" window

**CAPABILITIES:**

The section "Capabilities" is used only to show which features/baudrates available in the PROFIBUS device. The Green Icon indicate that capability/baudrate is available, the Red Icon indicate no compatibilities with that capability/baudrate (Fig. 12).

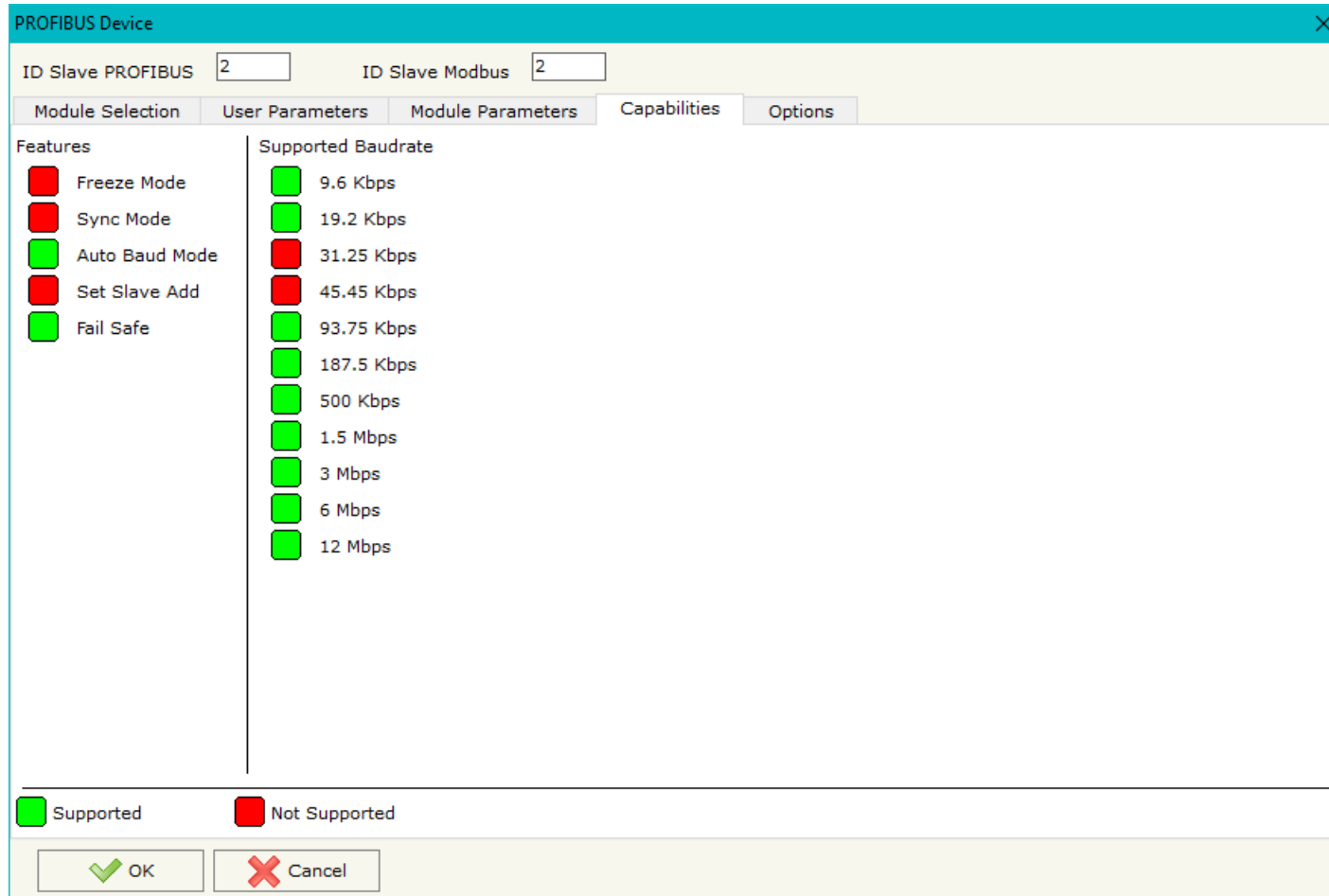

Figure 12: "PROFIBUS Device – Capabilities" window



**OPTIONS:**

The section "Options" is used to enable some option for each PROFIBUS device (Fig. 13).

The means of the fields are:

- In the field "**Enable Sync**" the PROFIBUS Sync command is enable. This option is enable only if the "Sync Mode" is supported by the device (see Capabilities section to check it);
- In the field "**Enable Freeze**" the PROFIBUS Freeze command is enable. This option is enable only if the "Freeze Mode" is supported by the device (see Capabilities section to check it);
- In the field "**Reset data if PROFIBUS master loses communication with the slave**" is possible to select to cancel the data of the slave if the Master lost the connection with the device;
- In the field "**Reset data if Modbus Master doesn't poll data the slave in ... milliseconds**" is possible to select to cancel the data sented to the slave PROFIBUS if the Converter don't receive a Ethernet frame within the time expressed in the field.

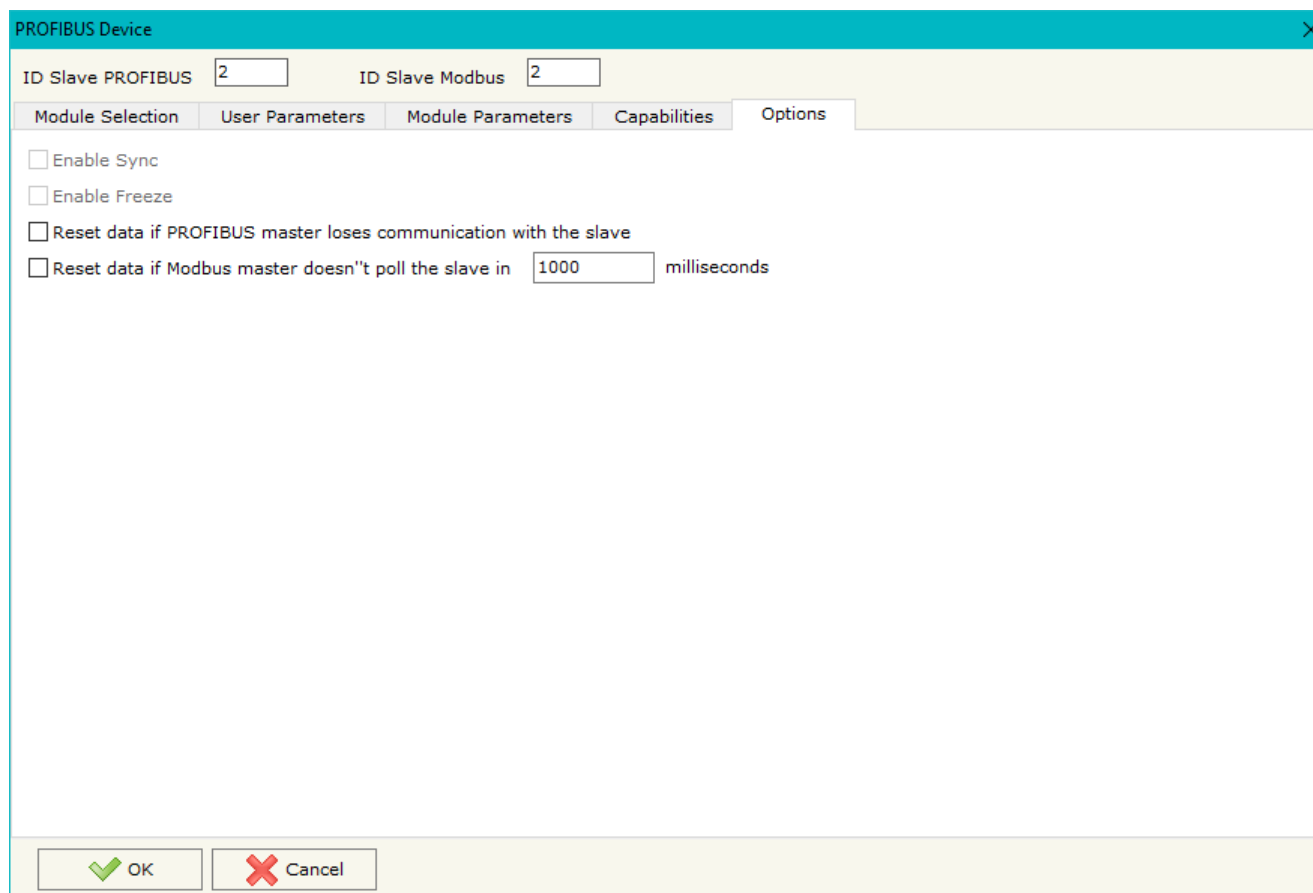

Figure 13: "PROFIBUS Device - Options" window

### UPDATE DEVICE:

By pressing the **Update Device** button it is possible to load the created Configuration into the device; and also the Firmware, if is necessary.

If you don't know the actual IP address of the device you have to use this procedure:

- Turn OFF the Device;
- Put Dip2 of 'Dip-Switch A' at ON position;
- Turn ON the device
- Connect the Ethernet cable;
- Insert the IP **"192.168.2.205"**;
- Press the **"Ping"** button, must appear "Device Found!";
- Press the **"Next"** button;
- Select which operations you want to do;
- Press the **"Execute update firmware"** button to start the upload;
- When all the operations are "OK" turn OFF the Device;
- Put Dip2 of 'Dip-Switch A' at OFF position;
- Turn ON the device.

If you know the actual IP address of the device you have to use this procedure:

- Turn ON the Device with the Ethernet cable inserted;
- Insert the actual IP of the Converter;
- Press the **"Ping"** button, must appear "Device Found!";
- Press the **"Next"** button;
- Select which operations you want to do;
- Press the **"Execute update firmware"** button to start the upload;
- When all the operations are "OK" the device automatically goes at Normal Mode.

At this point the configuration/firmware on the device is correctly update.

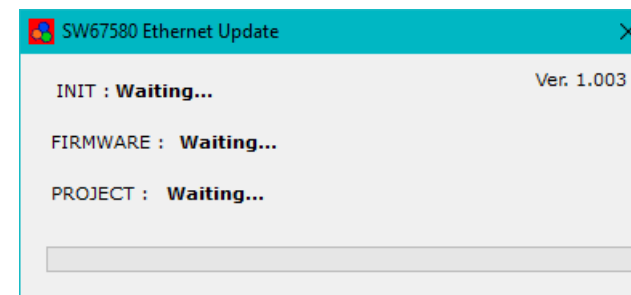
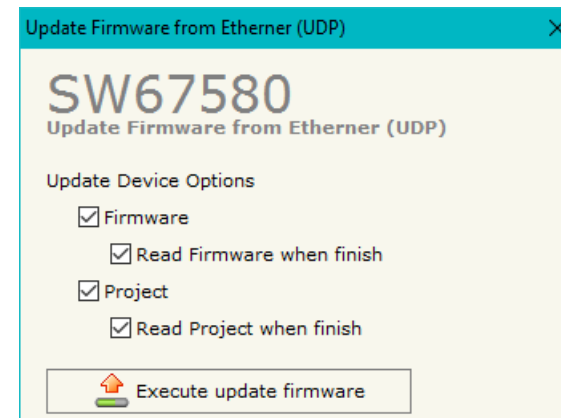
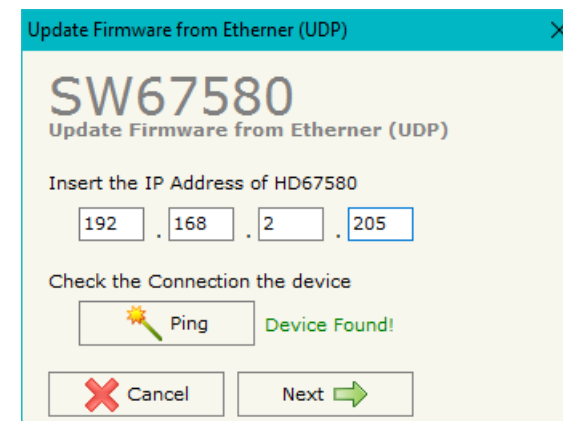





Figure 14: "Update device" windows

 **Note:**  
When you install a new version of the software it is better if the first time you do the update of the Firmware in the HD67580 device.

 **Note:**  
When you receive the device, for the first time, you have to update also the Firmware in the HD67580 device.

 **Warning:**  
If Fig. 15 appears when you try to do the Update try these points before seeking assistance:

- Try to repeat the operations for the updating;
- Try with another PC;
- Try to restart the PC;
- Check the LAN settings;
- Check the Wi-Fi settings;
- If you are using the program inside a Virtual Machine, try to use in the main Operating System;
- If you are using Windows Seven, Vista, 8 or 10 make sure that you have the administrator privileges;
- In case you have to program more than one device, using the "UDP Update", you have to cancel the ARP table every time you connect a new device on Ethernet. For do this you have to launch the "Command Prompt" and write the command "arp -d". Pay attention that with Windows Vista, Seven, 8, 10 you have to launch the "Command Prompt" with Administrator Rights;
- Pay attention at Firewall lock.

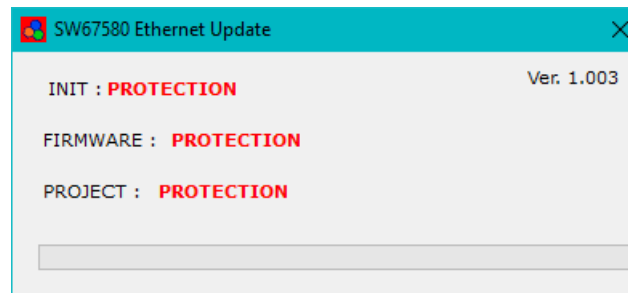



Figure 15: "Protection" window

 In the case of HD67580 you have to use the software "SW67580": [www.adfweb.com/download/filefold/SW67580.zip](http://www.adfweb.com/download/filefold/SW67580.zip).

### MODBUS MAP:

On Modbus side, the map is created automatically. In relation to the configuration defined, it is possible to have two different maps. Each PROFIBUS Slave will be mapped into a different virtual Modbus ID (in relation to the field "ID Slave Modbus" of "PROFIBUS Network -> PROFIBUS Device" section)

#### Read with Input Register / Status Function not enabled

Data in reading:

Type	Address	Function	Description
Holding Register	0	03	Input Bytes 0-1 of PROFIBUS side
Holding Register	1	03	Input Bytes 2-3 of PROFIBUS side
Holding Register	2	03	Input Bytes 4-5 of PROFIBUS side
.			
Holding Register	121	03	Input Bytes 242-243 of PROFIBUS side

Data in writing:

Type	Address	Function	Description
Holding Register	0	06/16	Output Bytes 0-1 of PROFIBUS side
Holding Register	1	06/16	Output Bytes 2-3 of PROFIBUS side
Holding Register	2	06/16	Output Bytes 4-5 of PROFIBUS side
.			
Holding Register	121	06/16	Output Bytes 242-243 of PROFIBUS side



#### Note:

The data can be read/written as single bits too using Coil Status (Function 01 and Functions 05/15).

Read with Input Register / Status Function enabled

Data in reading:

Type	Address	Function	Description
Input Register	0	04	Input Bytes 0-1 of PROFIBUS side
Input Register	1	04	Input Bytes 2-3 of PROFIBUS side
Input Register	2	04	Input Bytes 4-5 of PROFIBUS side
.			
Input Register	121	04	Input Bytes 242-243 of PROFIBUS side

Data in writing:

Type	Address	Function	Description
Holding Register	0	R: 03 W: 06/16	Output Bytes 0-1 of PROFIBUS side
Holding Register	1	R: 03 W: 06/16	Output Bytes 2-3 of PROFIBUS side
Holding Register	2	R: 03 W: 06/16	Output Bytes 4-5 of PROFIBUS side
.			
Holding Register	121	R: 03 W: 06/16	Output Bytes 242-243 of PROFIBUS side

Note:

The data can be read/written as single bits too using Input/Coil Status (Function 02 and Functions 01/05/15).

**MECHANICAL DIMENSIONS:**

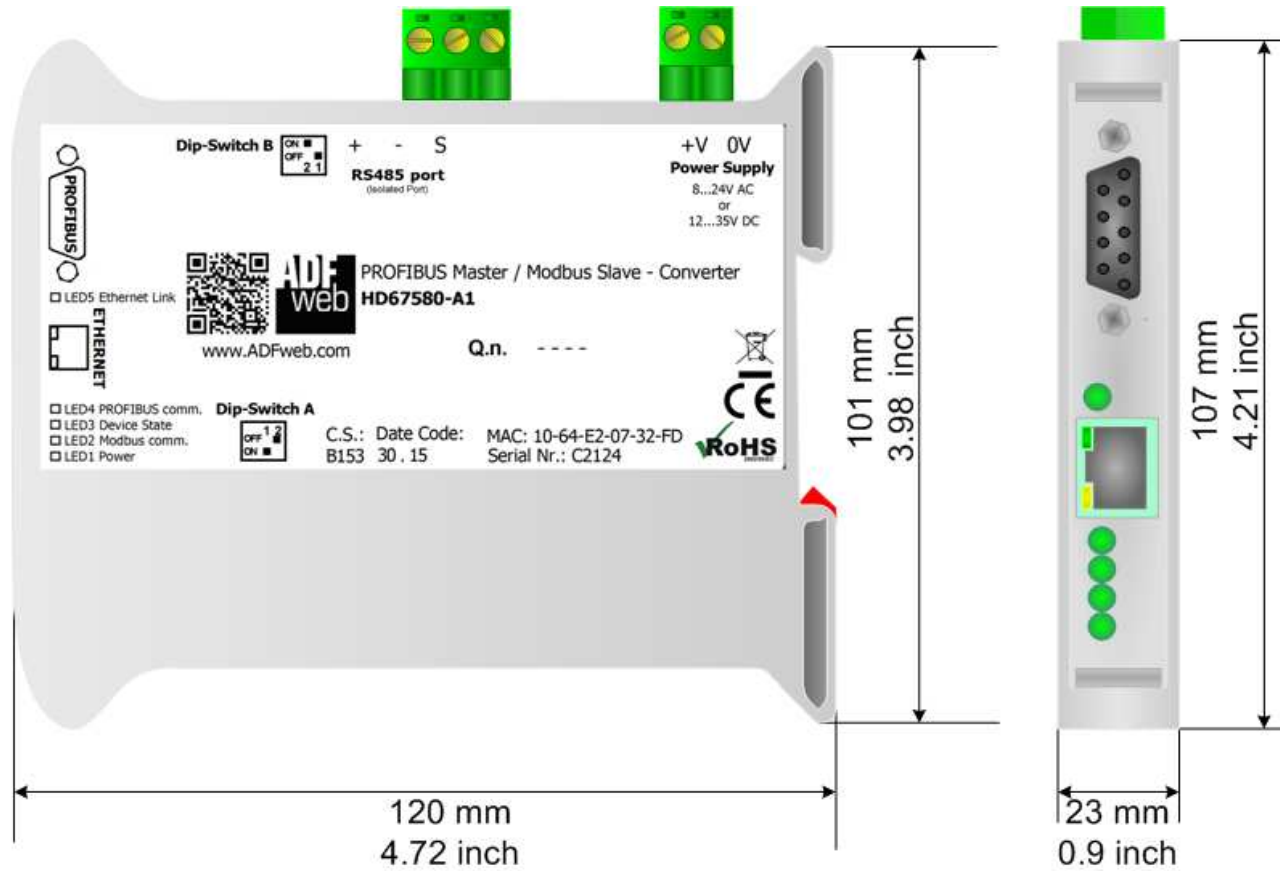

Housing: PVC  
Weight: 200g (Approx)

Figure 16: Mechanical dimensions scheme

**ORDERING INFORMATIONS:**

The ordering part number is formed by a valid combination of the following:

**HD67580 - A 1****Connectors Type**

1: Removable 5mm Screw Terminal

**Enclosure Type**

A: 1M, 35mm DIN Rail mounting

**Device Family**

HD67580: PROFIBUS Master / Modbus Slave - Converter

Order Code: **HD67580-A1** - PROFIBUS Master / Modbus Slave - Converter

**ACCESSORIES:**

Order Code: **AC34001** - Rail DIN - Power Supply 220/240V AC 50/60Hz - 12 V AC

Order Code: **AC34002** - Rail DIN - Power Supply 110V AC 50/60Hz - 12 V AC

**DISCLAIMER:**

All technical content within this document can be modified without notice. The content of the document is a under continual renewal. For losses due to fire, earthquake, third party access or other accidents, or intentional or accidental abuse, misuse, or use under abnormal conditions repairs are charged to the user. ADFweb.com S.r.l. will not be liable for accidental loss of use or inability to use this product, such as loss of business income. ADFweb.com S.r.l. shall not be liable for consequences of improper use.

**OTHER REGULATIONS AND STANDARDS:****WEEE INFORMATION**

Disposal of old electrical and electronic equipment (as in the European Union and other European countries with separate collection systems).

— This symbol on the product or on its packaging indicates that this product may not be treated as household rubbish. Instead, it should be taken to an applicable collection point for the recycling of electrical and electronic equipment. If the product is disposed correctly, you will help prevent potential negative environmental factors and impact of human health, which could otherwise be caused by inappropriate disposal. The recycling of materials will help to conserve natural resources. For more information about recycling this product, please contact your local city office, your household waste disposal service or the shop where you purchased the product.

**RESTRICTION OF HAZARDOUS SUBSTANCES DIRECTIVE**

The device respects the 2002/95/EC Directive on the restriction of the use of certain hazardous substances in electrical and electronic equipment (commonly referred to as Restriction of Hazardous Substances Directive or RoHS).

**CE MARKING**

The product conforms with the essential requirements of the applicable EC directives.



**WARRANTIES AND TECHNICAL SUPPORT:**

For fast and easy technical support for your ADFweb.com SRL products, consult our internet support at [www.adfweb.com](http://www.adfweb.com). Otherwise contact us at the address [support@adfweb.com](mailto:support@adfweb.com)

**RETURN POLICY:**

If while using your product you have any problem and you wish to exchange or repair it, please do the following:

- ➔ Obtain a Product Return Number (PRN) from our internet support at [www.adfweb.com](http://www.adfweb.com). Together with the request, you need to provide detailed information about the problem.
- ➔ Send the product to the address provided with the PRN, having prepaid the shipping costs (shipment costs billed to us will not be accepted).

If the product is within the warranty of twelve months, it will be repaired or exchanged and returned within three weeks. If the product is no longer under warranty, you will receive a repair estimate.



**ADFweb.com S.r.l.**  
Via Strada Nuova, 17  
IT-31010 Mareno di Piave  
TREVISO (Italy)  
Phone +39.0438.30.91.31  
Fax +39.0438.49.20.99  
[www.adfweb.com](http://www.adfweb.com)

