

User Manual

Revision 1.004
English

PROFINET / Modbus Master - Converter

(Order Code: HD67602-232-A1, HD67602-485-A1)

For Website information:

www.adfweb.com?Product=HD67602

For Price information:

www.adfweb.com?Price=HD67602-232-A1

www.adfweb.com?Price=HD67602-485-A1

Benefits and Main Features:

- ⊕ Triple electrical isolation
- ⊕ Two PROFINET ports
- ⊕ Temperature range: -40°C/+85°C (-40°F/+185°F)



For others PROFINET products, see also the following links:

Converter PROFINET to

- www.adfweb.com?Product=HD67600
- www.adfweb.com?Product=HD67601
- www.adfweb.com?Product=HD67601
- www.adfweb.com?Product=HD67603
- www.adfweb.com?Product=HD67603
- www.adfweb.com?Product=HD67604
- www.adfweb.com?Product=HD67605
- www.adfweb.com?Product=HD67606
- www.adfweb.com?Product=HD67607
- www.adfweb.com?Product=HD67608
- www.adfweb.com?Product=HD67609
- www.adfweb.com?Product=HD67610

- (NMEA2000)**
- (Serial RS232)**
- (Serial RS485)**
- (Modbus Slave RS232)**
- (Modbus Slave RS485)**
- (PROFIBUS Master)**
- (PROFIBUS Slave)**
- (CAN)**
- (CANopen)**
- (DeviceNet Master)**
- (DeviceNet Slave)**
- (J1939)**

Do you have your customer protocol? Then go to:

www.adfweb.com?Product=HD67003

Do you need to choose a device? Do you want help?

www.adfweb.com?Cmd=helpme



User Manual

INDEX:

	Page
INDEX	2
UPDATED DOCUMENTATION	2
REVISION LIST	2
WARNING	2
TRADEMARKS	2
SECURITY ALERT	3
EXAMPLE OF CONNECTION	4
CONNECTION SCHEME	5
CHARACTERISTICS	7
CONFIGURATION	7
POWER SUPPLY	8
FUNCTION MODES	9
LEDS	10
PROFINET	11
RS232	11
RS485	12
USE OF COMPOSITOR SW67602	13
NEW CONFIGURATION / OPEN CONFIGURATION	14
SOFTWARE OPTIONS	15
SET COMMUNICATION	16
SET ACCESS	17
UPDATE DEVICE	19
MODBUS DIAGNOSTIC OVER PROFINET	21
ADVANCED FUNCTIONS	22
MECHANICAL DIMENSIONS	28
ORDERING INFORMATIONS	28
ACCESSORIES	29
PLC CONFIGURATION	30
DISCLAIMER	35
OTHER REGULATIONS AND STANDARDS	35
WARRANTIES AND TECHNICAL SUPPORT	36
RETURN POLICY	36

UPDATED DOCUMENTATION:

Dear customer, we thank you for your attention and we remind you that you need to check that the following document is:

- ✚ Updated
- ✚ Related to the product you own

To obtain the most recently updated document, note the “document code” that appears at the top right-hand corner of each page of this document.

With this “Document Code” go to web page www.adfweb.com/download/ and search for the corresponding code on the page. Click on the proper “Document Code” and download the updates.

REVISION LIST:

Revision	Date	Author	Chapter	Description
1.000	14/09/2012	Dp	All	First Release
1.001	24/07/2013	Fl	All	Revision
1.002	07/03/2014	Ff & Fl	All	Add New Chapter
1.003	09/05/2014	Fl	All	Revision
1.004	29/05/2014	Ff	All	Add “Diagnostic” field

WARNING:

ADFweb.com reserves the right to change information in this manual about our product without warning.
ADFweb.com is not responsible for any error this manual may contain.

TRADEMARKS:

All trademarks mentioned in this document belong to their respective owners.

SECURITY ALERT:**GENERAL INFORMATION**

To ensure safe operation, the device must be operated according to the instructions in the manual. When using the device, legal and safety regulation are required for each individual application. The same applies also when using accessories.

INTENDED USE

Machines and systems must be designed so the faulty conditions do not lead to a dangerous situation for the operator (i.e. independent limit switches, mechanical interlocks, etc.).

QUALIFIED PERSONNEL

The device can be used only by qualified personnel, strictly in accordance with the specifications.

Qualified personnel are persons who are familiar with the installation, assembly, commissioning and operation of this equipment and who have appropriate qualifications for their job.

RESIDUAL RISKS

The device is state-of-the-art and is safe. The instruments can represent a potential hazard if they are inappropriately installed and operated by untrained personnel. These instructions refer to residual risks with the following symbol:



This symbol indicates that non-observance of the safety instructions is a danger for people that could lead to serious injury or death and / or the possibility of damage.

CE CONFORMITY

The declaration is made by our company. You can send an email to support@adfweb.com or give us a call if you need it.

EXAMPLE OF CONNECTION:

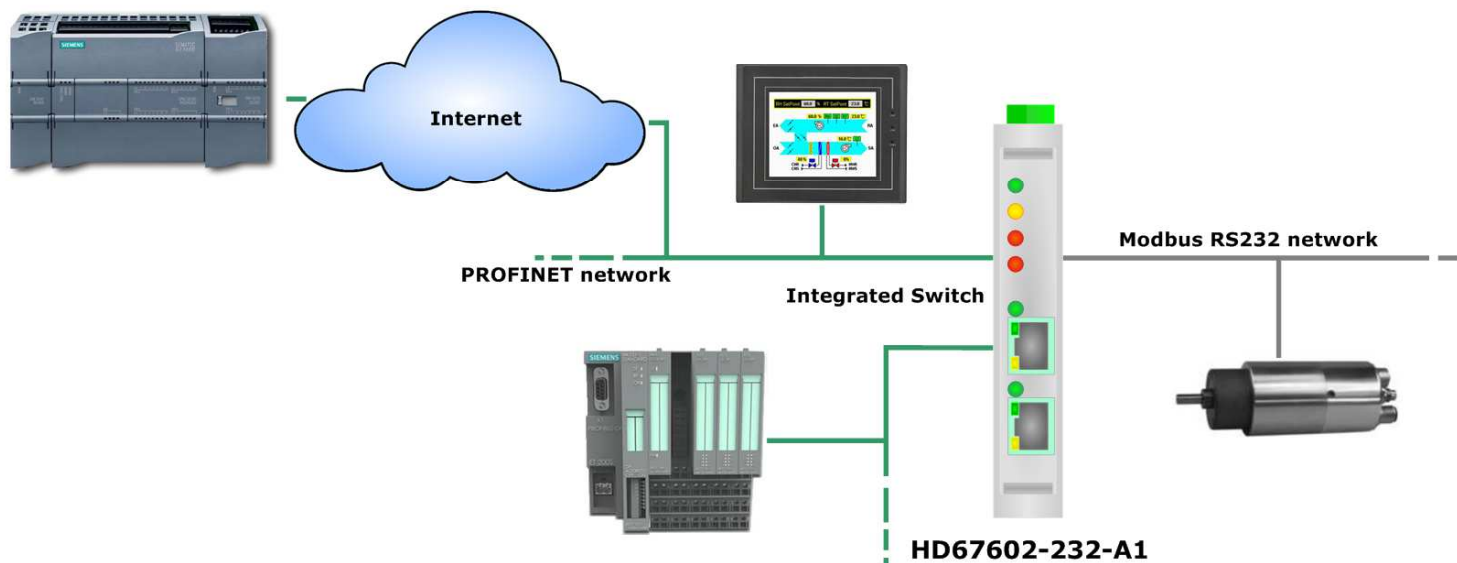
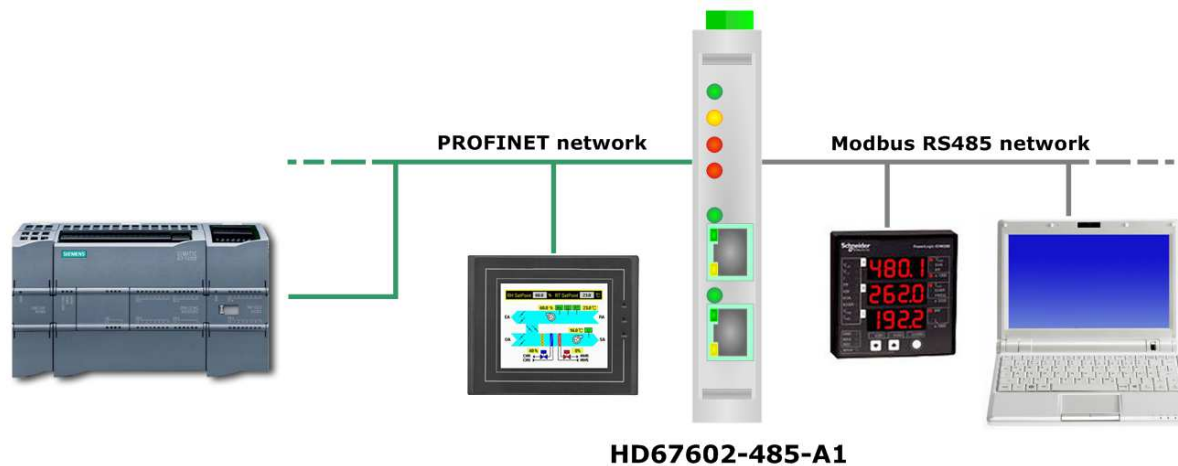

CONNECTION SCHEME:

Dip-Switch A:
 -Dip1 – Must be at ON
 -Dip2 – Functioning Mode

= Normal
 = Boot

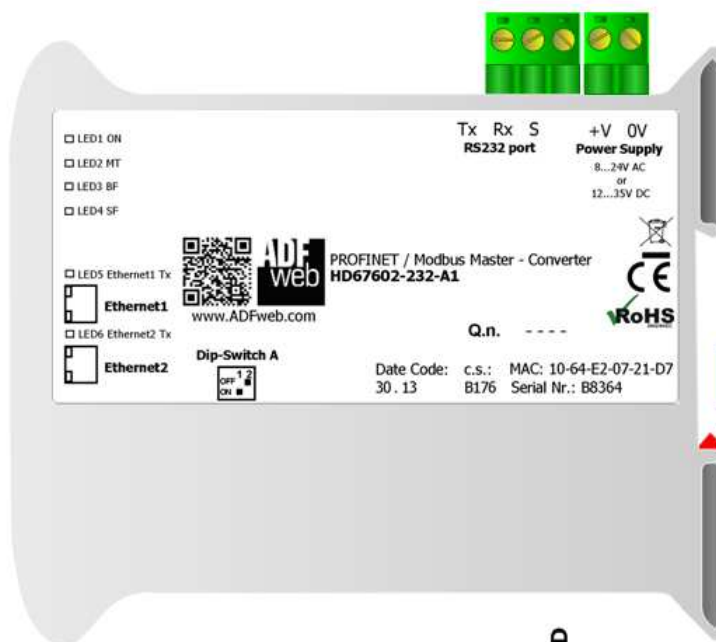

Led1: Green ON

Led2: Yellow MT

Led3: Red BF

Led4: Red SF

Led5: Green Ethernet1 Tx

Connector3: Ethernet1 Port (RJ45 Plug)

Led6: Green Ethernet2 Tx

Connector4: Ethernet2 Port (RJ45 Plug)



Connector2:
 RS232 (Isolated port)
 GND = Ground* (to Isolated Ground)
 Rx = Rx line
 Tx = Tx line

Connector1:
 Power Supply port
 0V = Ground
 +V = Positive wire
 V AC: min 8V ; max 24V
 V DC: min 12V ; max 35V

Figure 1a: Connection scheme for HD67602-232-A1

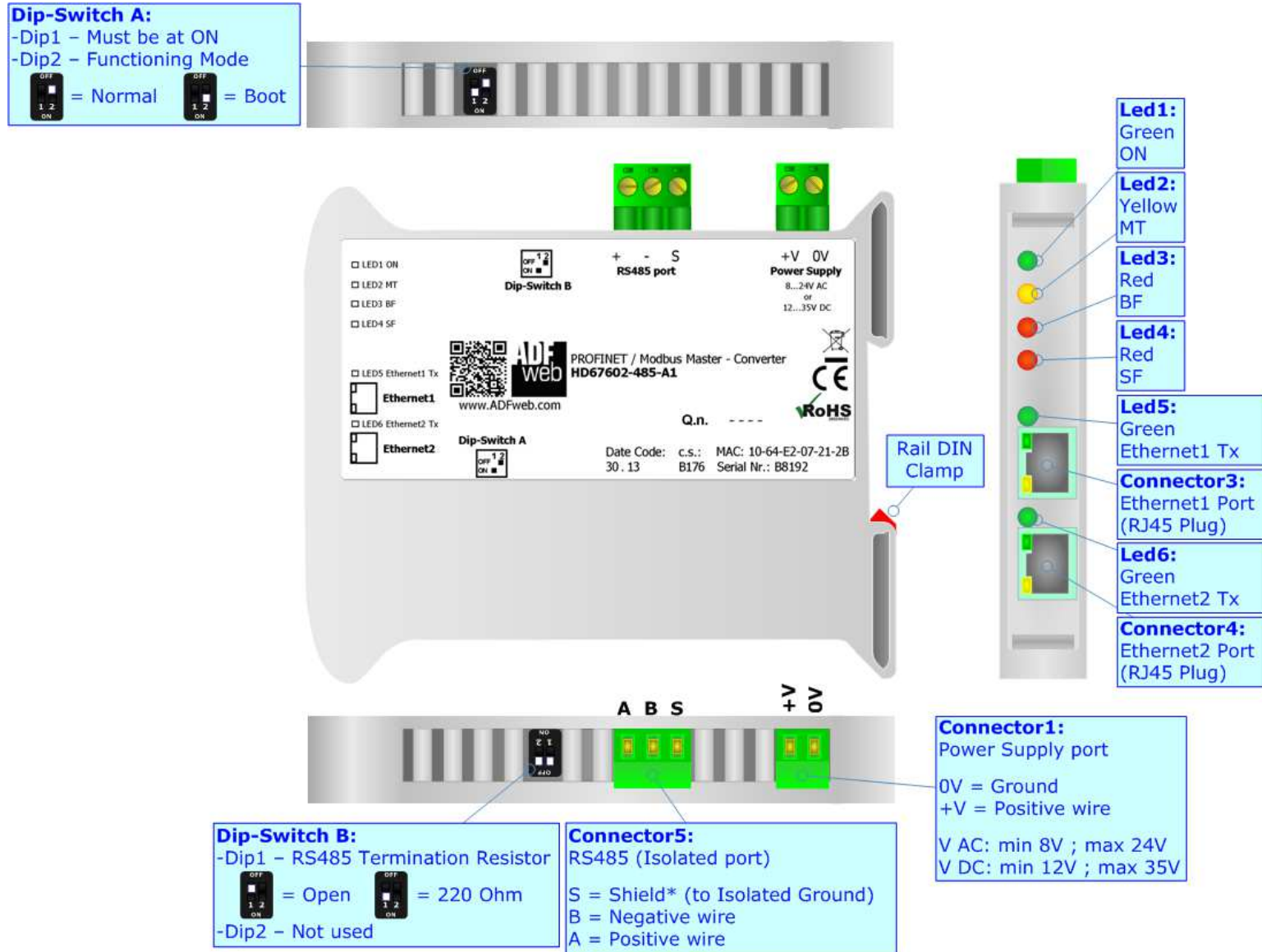

Figure 1b: Connection scheme for HD67602-485-A1

CHARACTERISTICS:

The HD67602-232-A1 and HD67602-485-A1 are a PROFINET / Modbus Master Converter.

They allows the following characteristics:

- Up to 512 bytes in reading and 512 bytes in writing;
- Triple isolation between Modbus - Power Supply, Modbus - Ethernet, Power Supply - Ethernet.
- Two-directional information between Modbus bus and PROFINET bus;
- Mountable on 35mm Rail DIN;
- Wide power supply input range: 8...24V AC or 12...35V DC;
- Wide temperature range: -40°C / 85°C [-40°F / +185°F].

CONFIGURATION:

You need Compositor SW67602 software on your PC in order to perform the following:

- Define the parameter of PROFINET line;
- Define the parameter of Modbus line;
- Define the data to Read in Modbus and where to map these information in the PROFINET array;
- Define the data to Write in Modbus and where to take the information in the PROFINET array;
- Update the device.

POWER SUPPLY:

The devices can be powered at 8...24V AC and 12...35V DC. For more details see the two tables below.

VAC		VDC	
Vmin	Vmax	Vmin	Vmax
8V	24V	12V	35V

Consumption at 24V DC:

Device	Consumption [W/VA]
HD67602-232-A1	3.5
HD67602-485-A1	3.5

Connector1:
Power Supply port
0V = Ground
+V = Positive wire
V AC: min 8V ; max 24V
V DC: min 12V ; max 35V

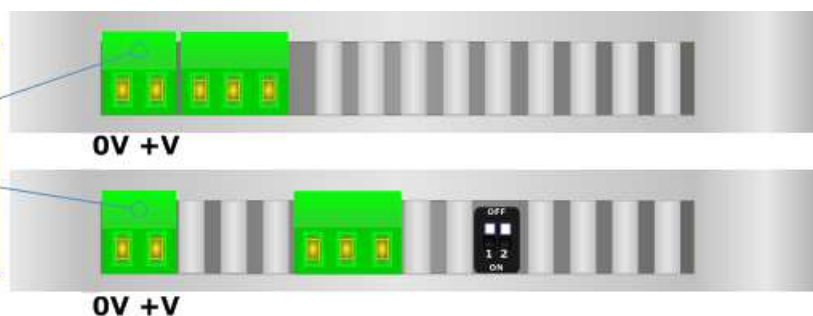

Caution: Not reverse the polarity power

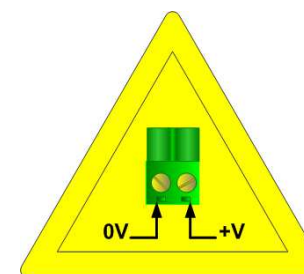

HD67602-xxx-A1

FUNCTION MODES:

The device has got two functions mode depending of the position of the 'Dip2 of Dip-Switch A':

- The first, with 'Dip2 of Dip-Switch A' at "OFF" position, is used for the normal working of the device.
- The second, with 'Dip2 of Dip-Switch A' at "ON" position, is used for upload the Project and/or Firmware.

For the operations to follow for the updating, see 'UPDATE DEVICE' section.

According to the functioning mode, the LEDs will have specifics functions, see 'LEDS' section.

**Warning:**

Dip1 of 'Dip-Switch A' must be at ON position for working even if the Ethernet cable isn't inserted.

LEDS:

The device has got six LEDs that are used to give information of the functioning status. The various meanings of the LEDs are described in the table below.

LED	Normal Mode	Boot Mode
1: ON [supply voltage] (green)	ON: Device powered OFF: Device not powered	ON: Device powered OFF: Device not powered
2: MT [maintenance display] (yellow)	ON: Maintenance Problem is present OFF: No maintenance are present	Blinks quickly: Boot state Blinks very slowly (~0.5Hz): update in progress
3: BF [bus fault] (red)	ON: The Ethernet connection is defective; the IP address exists several times in the network; the own NameOfStation exists several times in the network; no IP address has been set Flashing: At least one configured AR is no longer in the data exchange OFF: No errors are present	Blinks quickly: Boot state Blinks very slowly (~0.5Hz): update in progress
4: SF [group error] (red)	ON: At least one AR is not in the data exchange OFF: No errors are present	Blinks quickly: Boot state Blinks very slowly (~0.5Hz): update in progress
5: Ethernet1 Tx (green)	Blinks when is transmitting Ethernet frames	Blinks quickly: Boot state Blinks very slowly (~0.5Hz): update in progress
6: Ethernet2 Tx (green)	Blinks when is transmitting Ethernet frames	Blinks quickly: Boot state Blinks very slowly (~0.5Hz): update in progress

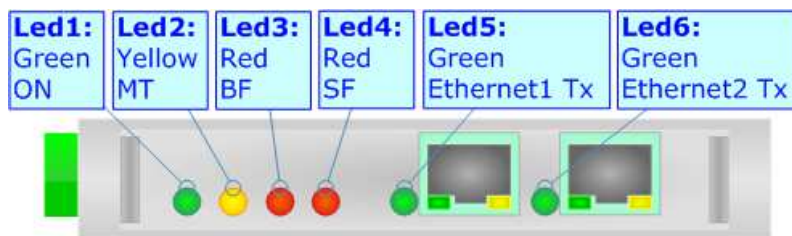

PROFINET:

The PROFINET connection must be made using Connector3 and/or Connector4 of HD67602-xxx-A1 with at least a Category 5E cable. The maximum length of the cable should not exceed 100m. The cable has to conform to the T568 norms relative to connections in cat.5 up to 100 Mbps. To connect the device to an Hub/Switch is recommended the use of a straight cable, to connect the device to a PC/PLC/other is recommended the use of a cross cable.

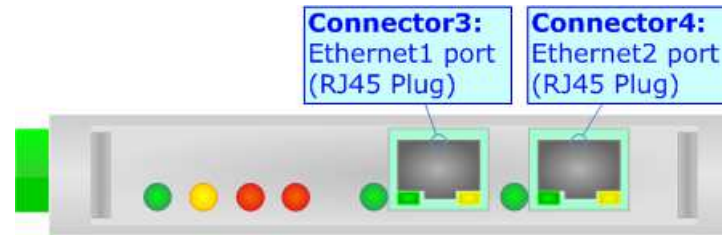

RS232:

The connection from RS232 socket to a serial port (example one from a personal computer) must be made with a NULL MODEM cable (a serial cable where the pins 2 and 3 are crossed). It is recommended that the RS232 cable not exceed 15 meters.

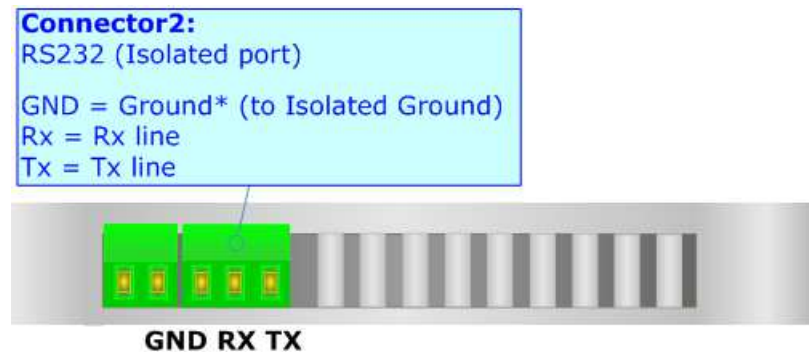

RS485:

For terminate the RS485 line with a 220Ω resistor it is necessary to put ON dip 1, like in figure.

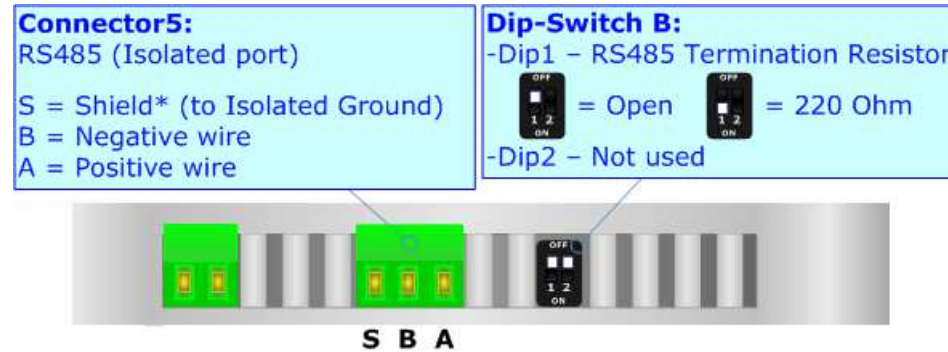

The maximum length of the cable should be 1200m (4000 feet).

Here some codes of cables:

- Belden: p/n 8132 - 2x 28AWG stranded twisted pairs conductor + foil shield + braid shield;
- Belden p/n 82842 - 2x 24AWG stranded twisted pairs conductor + foil shield + braid shield;
- Tasker: p/n C521 - 1x 24AWG twisted pair conductor + foil shield + braid shield;
- Tasker: p/n C522 - 2x 24AWG twisted pairs conductor + foil shield + braid shield.

USE OF COMPOSITOR SW67602:

To configure the Converter, use the available software that runs with Windows called SW67602. It is downloadable on the site www.adfweb.com and its operation is described in this document. (*This manual is referenced to the last version of the software present on our web site*). The software works with MSWindows (XP, Vista, Seven, 8; 32/64bit).

When launching the SW67602, the window below appears (Fig. 2).



Note:

It is necessary to have installed .Net Framework 4.

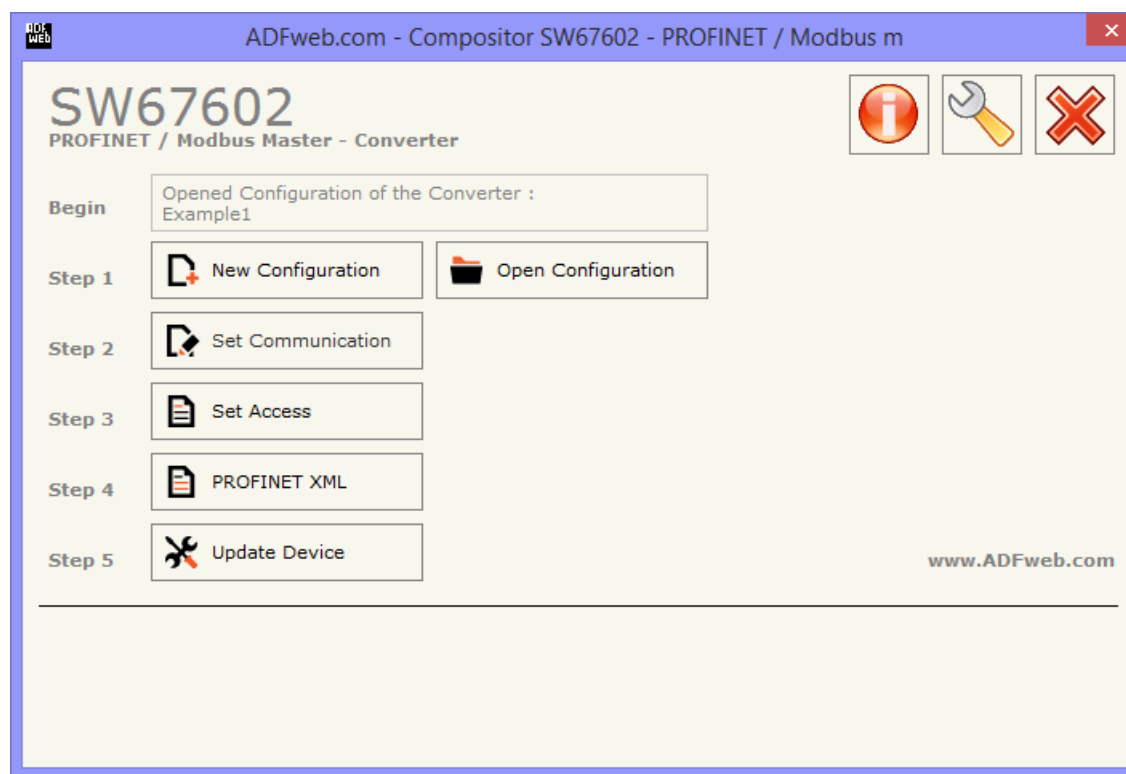

Figure 2: Main window for SW67602

NEW CONFIGURATION / OPEN CONFIGURATION:

The “**New Configuration**” button creates the folder which contains the entire device’s configuration.



A device’s configuration can also be imported or exported:

- To clone the configurations of a Programmable “PROFINET Slave / Modbus Master - Converter” in order to configure another device in the same manner, it is necessary to maintain the folder and all its contents;
- To clone a project in order to obtain a different version of the project, it is sufficient to duplicate the project folder with another name and open the new folder with the button “**Open Configuration**”.

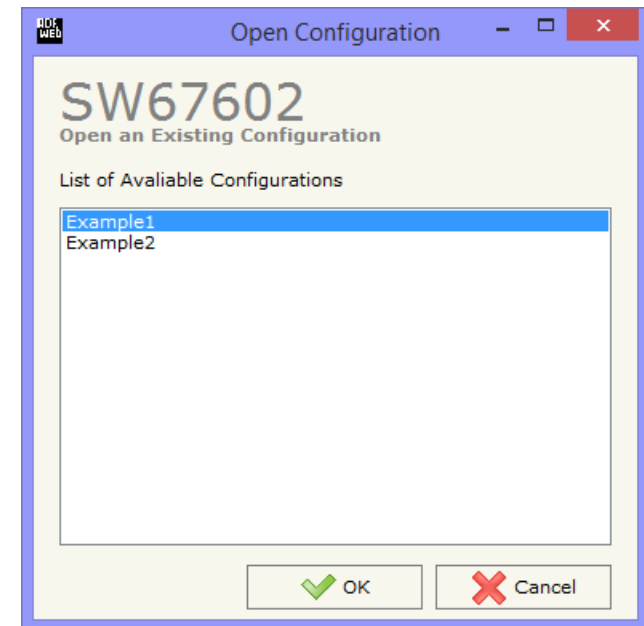

SOFTWARE OPTIONS:

By pressing the “**Settings**” () button there is the possibility to change the language of the software and check the updatings for the compositor.

In the section “Language” it is possible to change the language of the software.

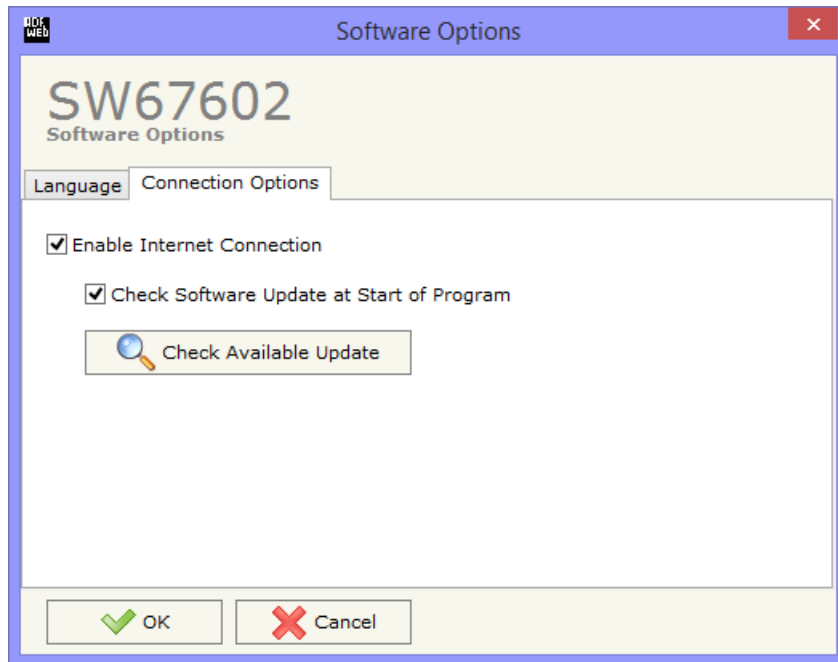

In the section “Connection Options”, it is possible to check if there are some updatings of the software compositor in ADFweb.com website. Checking the option “**Check Software Update at Start of Program**”, the SW67602 check automatically if there are updatings when it is launched.

SET COMMUNICATION:

This section define the fundamental communication parameters of two buses, PROFINET and Modbus.

By Pressing the **"Set Communication"** button from the main window for SW67602 (Fig. 2) the window "Set Communication" appears (Fig. 3).

The window is divided in two sections, one for the PROFINET and the other for the Modbus Master.

The means of the fields for "PROFINET" are:

- In the fields **"IP ADDRESS"** insert the IP address that you want to give to the Converter;
- In the fields **"SUBNET Mask"** insert the SubNet Mask;
- In the fields **"GATEWAY"** insert the default gateway that you want to use. This feature can be enabled or disabled pressing the Check Box field. This feature is used for going out of the net;
- In the field **"Port"** is possible to define the port to use for the "Tunneling mode" (see page 22 for more details);
- In the field **"PROFINET Name of Station"** is possible to assign a name to the PROFINET node;
- In the fields **"Number Byte IN"** insert the number of input byte of the slave station;
- In the fields **"Number Byte Out"** insert the number of output byte of the slave station;
- In the field **"Diagnostic"** insert the starting byte of the PROFINET array where you will save the diagnostic of Modbus. It is possible to enable/disable this function using the checkbox. For more informations about the diagnostic, see "Diagnostic" section on page 21.

The means of the fields for the "Modbus Master" section are:

- In the field **"Serial"** the serial to use is defined (RS232 or RS485);
- In the field **"Baudrate"** the baudrate for the serial line is defined;
- In the field **"Parity"** the parity of the serial line is defined;
- In the field **"TimeOut (ms)"** there is the maximum time that the device attends for the answer from the Slave interrogated;
- In the field **"Communication Idle Time (ms)"** the minimum delay between two polls is defined.

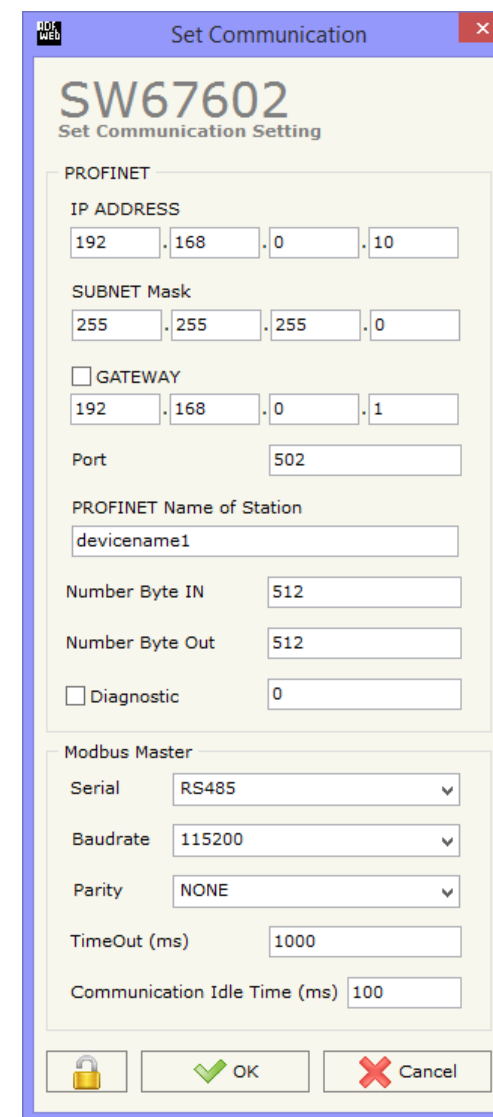

Figure 3: "Set Communication" window

SET ACCESS:

By pressing the **"Set Access"** button from the main window for SW67602 (Fig. 2) the window "Set Access" appears.

This window is divided in two parts, the "Modbus Read" (Fig. 4) and the "Modbus Write" (Fig. 5).

The first part "Modbus Read" is used to read the data from the Modbus slaves, and make them available to read from the Master PROFINET.

The second part "Modbus Write" is used to write the data that arrives from the Master PROFINET into the slaves Modbus.

MODBUS READ

The means of the fields are:

- ✚ In the field **"Slave ID"** the address of the Modbus device you have to read is defined;
- ✚ In the field **"Type"** insert the data type of the register you would like to read. You can choose between the following:
 - Coil Status;
 - Input Status
 - Holding Register;
 - Input Register.
- ✚ In the field **"Address"** the start address of the register to be read is defined;
- ✚ In the field **"NPoint"** insert the number of consecutive registers to be read;
- ✚ In the field **"Poll Time"** insert the time to make this request;
- ✚ In the field **"Max Error"** is the number of errors continues that the gateway waits before suspending the poll until the next reboot. If is set to zero this function is disabled;
- ✚ In the field **"Position"** insert the address of the PROFINET array where place the information;
- ✚ In the field **"Start Bit"** insert the start bit of the first byte of the field "Position" where start to insert the data read. Valid only for the "Coil Status" and "Input Status".
- ✚ In the field **"Mnemonic"** the description for the request is defined.

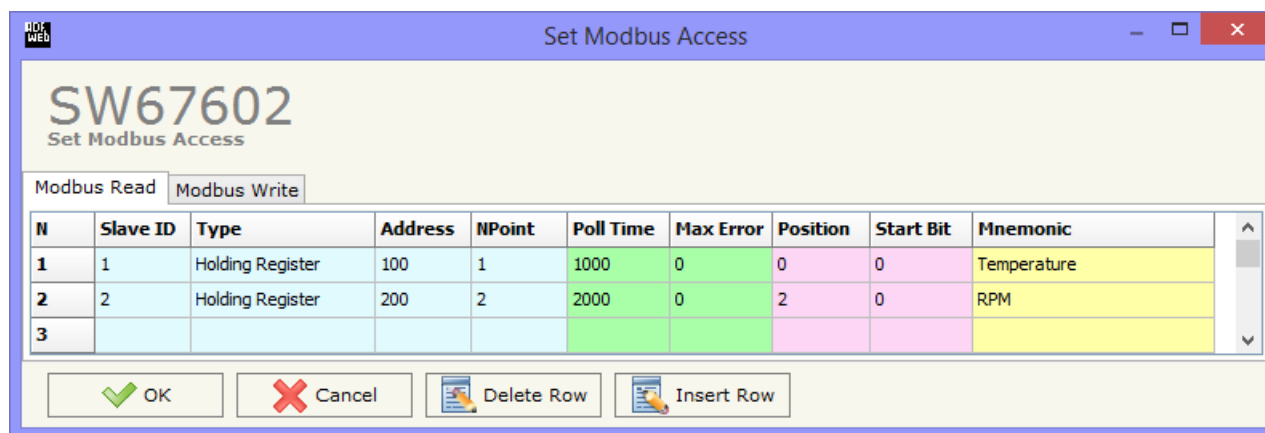

Figure 4: "Set Access → Modbus Read" window

MODBUS WRITE

The means of the fields are:

- ✦ In the field "**Slave ID**" the address of the Modbus device that you have to write is defined;
- ✦ In the field "**Type**" insert the data type of the register you would like to read. You can choose between the following:
 - Coil Status;
 - Holding Register;
- ✦ In the field "**Address**" the start address of the register to be written is defined;
- ✦ In the field "**NPoint**" insert the number of consecutive registers to be written;
- ✦ In the field "**Poll Time**" insert the time to make this request;
- ✦ If the field "**On Change**" is checked, the gateway send the Write request in Modbus when the data change the value.
- ✦ In the field "**Max Error**" is the number of errors continues that the gateway waits before suspending the poll until the next reboot. If is set to zero this function is disabled;
- ✦ In the field "**Position**" insert the address of the PROFINET array where read the information;
- ✦ In the field "**Start Bit**" insert the start bit of the first byte of the field "Position" where start to read the data to write. Valid only for the "Coil Status";
- ✦ In the field "**Mnemonic**" the description for the request is defined.

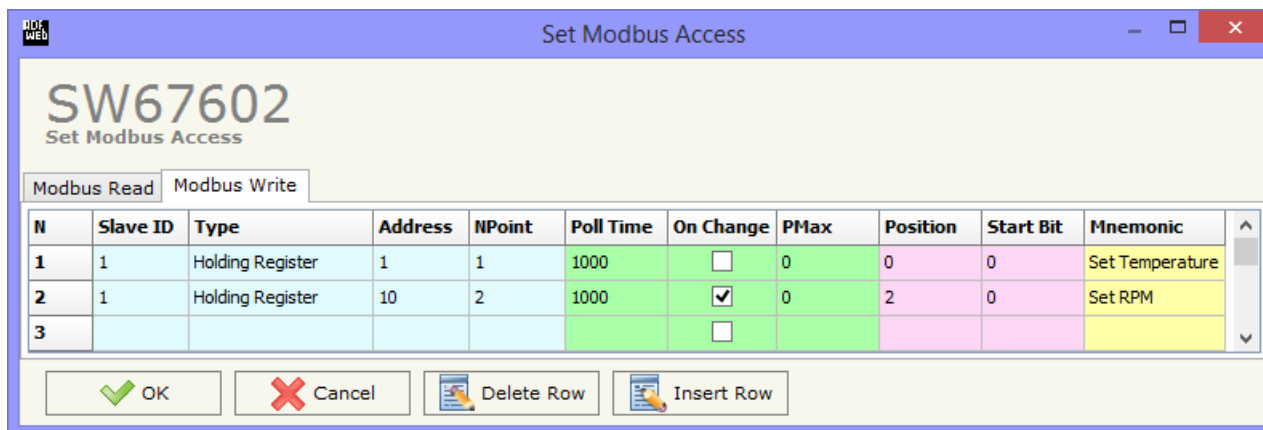

Figure 5: "Set Access → Modbus Write" window

- Note:
If you want that the converter sends the data only "On change" the "Poll Time" must be at 0.
- Note:
If the field "On change" is checked and the "Poll Time" is different from 0, the converter sends the Write request cyclically and also when the data is changed.

UPDATE DEVICE:

By pressing the **"Update Device"** button it is possible to load the created Configuration into the device; and also the Firmware, if is necessary.

If you don't know the actual IP address of the device you have to use this procedure:

- Turn off the Device;
- Put Dip2 of 'Dip-Switch A' at ON position;
- Turn on the device
- Connect the Ethernet cable;
- Insert the IP **"192.168.2.205"**;
- Press the **"Ping"** button, must appear "Device Found!";
- Press the **"Next"** button;
- Select which operations you want to do;
- Press the **"Execute update firmware"** button to start the upload;
- When all the operations are "OK" turn off the Device;
- Put Dip2 of 'Dip-Switch A' at OFF position;
- Turn on the device.

At this point the configuration/firmware on the device is correctly updated.

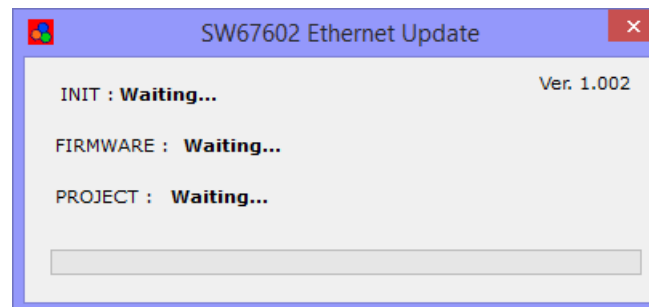
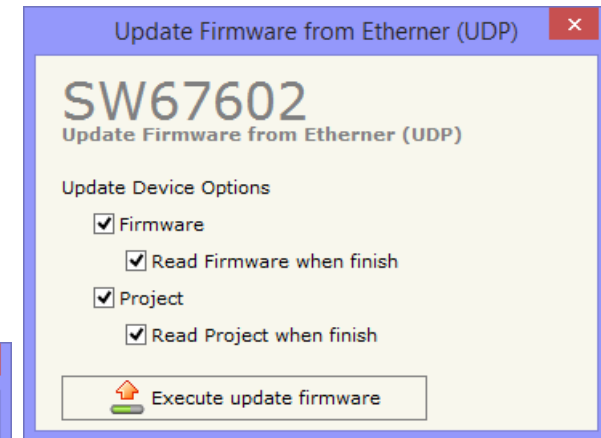
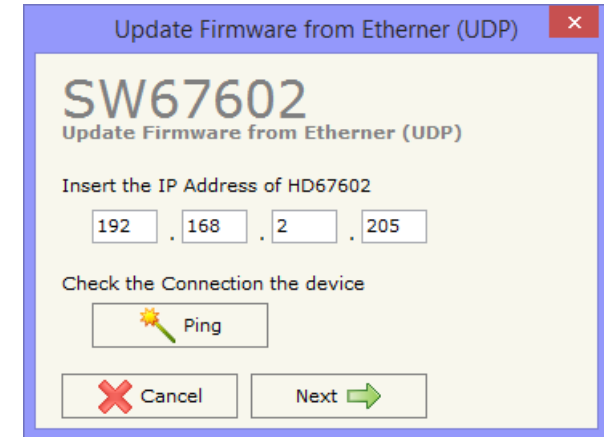

Figure 6: "Update device" windows

If you know the actual IP address of the device you have to use this procedure:

- Turn on the Device with the Ethernet cable inserted;
- Insert the actual IP of the Converter;
- Press the "**Ping**" button, must appear "Device Found!";
- Press the "**Next**" button;
- Select which operations you want to do;
- Press the "**Execute update firmware**" button to start the upload;
- When all the operations are "OK" the device automatically goes at Normal Mode.

At this point the configuration/firmware on the device is correctly update.



Note:

When you install a new version of the software it is better if the first time you do the update of the Firmware in the HD67602-232-A1 or HD67602-485-A1 device.



Note:

When you receive the device, for the first time, you have to update also the Firmware in the HD67602-232-A1 or HD67602-485-A1 device.



Warning:

If the Fig. 7 appears when you try to do the Update before require assistance try these points:

- Try to repeat the operations for the updating;
- Try with another PC;
- Try to restart the PC;
- If you are using the program inside a Virtual Machine, try to use in the main Operating System;
- If you are using Windows Seven or Vista or 8, make sure that you have the administrator privileges;
- Take attention at Firewall lock;
- Check the LAN settings.

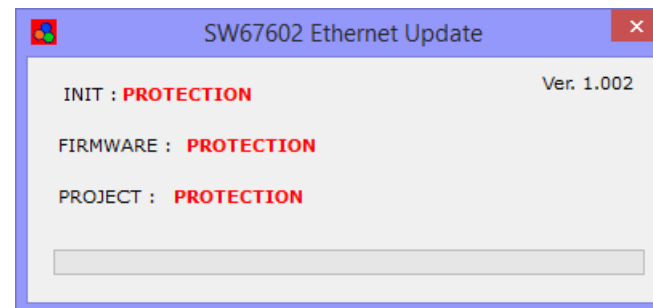

Figure 7: "Protection" window



In the case of HD67602-232-A1 or HD67602-485-a1 you have to use the software "SW67602":

www.adfweb.com/download/filefold/SW67602.zip.

MODBUS DIAGNOSTIC OVER PROFINET:

During the normal functioning of the device, if all the programmed Modbus requests have received a valid reply (not an exception error), every PROFINET frame has the "Data Status" byte at the value of 0x35.

Otherwise, if at least one Modbus reply is not valid, the "Data Status" byte assumes the value 0x15; that means "Problem Indicator".

If this happens, using the port 5000 there is a UDP message that is possible to send in order to understand which Modbus modules have generated that error.

This command is described in the section "Advanced Functions" under the "B2 command".

Moreover, it is possible to save the Modbus Diagnostic on Output PROFINET array using the field "Diagnostic" of the section "Set Communication".

In this case, the status of each Modbus request defined in the section "Set Access" is saved starting from the byte of the PROFINET array defined in the section "Set Communication".

Each bit will represent the status of a Modbus request:

- If for a request the converter receives a correct response, the status bit is put to '0';
- If for a request the converter receives a wrong response or it doesn't receive any response, the status bit is put to '1'.

Example:

In the section "Set Access" are defined 8 Modbus reading requests ("Modbus Read" table) and 8 Modbus writing requests ("Modbus Write" table). The Modbus reading requests are working and the Modbus writing request are not working.

The status bits of the Modbus Diagnostic on PROFINET will be:

Byte x								Byte x+1							
bit7	bit6	bit5	bit4	bit3	bit2	bit1	bit0	bit7	bit6	bit5	bit4	bit3	bit2	bit1	bit0
0	0	0	0	0	0	0	0	1	1	1	1	1	1	1	1

where 'x' is the starting byte of the PROFINET array where the Modbus diagnostic is saved.

ADVANCED FUNCTIONS:

In the HD67602-A1 are implemented some advanced commands that allows to check the functioning of the converter and send some Modbus commands directly from Ethernet side. To use them, it is necessary to send UDP messages to the port 5000.

The function of each command and the structure of the UDP messages are described below.

B0 command

This command allows to enable/disable the Modbus polls on Modbus side.

REQ:

Byte 0	B1/bit7	B1/bit6	B1/bit5	B1/bit4	B1/bit3	B1/bit2	B1/bit1	B1/bit0	...	Bn/bitn
0xB0	Poll 0	Poll 1	Poll 2	Pol 3	Poll 4	Poll 5	Poll 6	Poll 7	...	Poll x

1 = Poll disabled

0 = Poll enabled

If the message is received correctly, the same message will be sent back by the converter.

 Note:

In the UDP message, after the command's identifier, you have to enable/disable the Modbus reading requests and then the Modbus Writing requests.

Example:

In the section "Set Access" are defined 8 Modbus reading requests ("Modbus Read" table) and 8 Modbus writing requests ("Modbus Write" table). We want to disable the firsts 4 Modbus reading requests and the firsts 4 Modbus writing requests.

Byte 0	Byte 1								Byte 2							
0xB0	bit7	bit6	bit5	bit4	bit3	bit2	bit1	bit0	bit7	bit6	bit5	bit4	bit3	bit2	bit1	bit0
	Poll0	Poll1	Poll2	Poll3	Poll4	Poll5	Poll6	Poll7	Poll8	Poll9	Poll10	Poll11	Poll12	Poll13	Poll14	Poll15
	1	1	1	1	0	0	0	0	1	1	1	1	0	0	0	0

B1 command

This command allows to read the status of the enabling/disabling of the Modbus polls.

REQ:

Byte 0
0xB1

RES:

Byte 0	B1/bit0	B1/bit1	B1/bit2	...	Bn/bitn
0xB1	Poll 0	Poll 1	Poll 2	...	Poll x

1 = Poll disabled

0 = Poll enabled



Note:

In the UDP message, after the command's identifier (0xB1), you can read the status of the Modbus Reading requests and then the status of the Modbus writing requests.

Example:

Referring to the previous example, if we read the status of the enabling/disabling, the response from the converter will be:

Byte 0	Byte 1								Byte 2							
0xB0	bit7	bit6	bit5	bit4	bit3	bit2	bit1	bit0	bit7	bit6	bit5	bit4	bit3	bit2	bit1	bit0
	Poll0	Poll1	Poll2	Poll3	Poll4	Poll5	Poll6	Poll7	Poll8	Poll9	Poll10	Poll11	Poll12	Poll13	Poll14	Poll15
	1	1	1	1	0	0	0	0	1	1	1	1	0	0	0	0

B2 command

This command allows to see the number of errors for each Modbus poll defined in the section "Set Access".

REQ:

Byte 0
0xB2

RES:

Byte 0	Byte 1	Byte 2	Byte 3	Byte 4	Byte 5	Byte 6	Byte 7	Byte 8	...
0xB2	Number of errors for Poll 1				Number of errors for Poll 2				...



Note:

In the UDP message, after the command's identifier (0xB2), you can read the number of errors for the Modbus Reading requests and then for the Modbus writing requests defined in the section "Set Access".

Example:

We have defined one Modbus Reading request and one Modbus Writing request in the section "Set Access". We want to know the number of error for each poll, so we use the B2 command

REQ:

Byte 0
0xB2

RES:

Byte 0	Byte 1	Byte 2	Byte 3	Byte 4	Byte 5	Byte 6	Byte 7	Byte 8
Identifier	Number of error for poll 1				Number of error for poll 2			
0xB2	0x00	0x00	0x00	0x00	0x00	0x00	0x00	0x05

In this example, for the Modbus poll 1 (Modbus Reading request) the errors are 0 and for the Modbus poll 2 (Modbus Writing Request) the errors are 5.

B3 command

This command allows to enable the Transparent: it will be possible to send Modbus commands directly from Ethernet side. The converter will become completely transparent.

Byte 0	Byte 1
0xB3	Enabling/disabling of Transparent Mode

0x01 = Poll disabled

0x00 = Poll enabled

If the message is received correctly, the same message will be sent back by the converter.



Note:

When the Transparent Mode is enabled, the Modbus polling will stop on Modbus side.



Note:

The port used for send/receive the frames is defined in the section "Set Communication" step, in the field "Port".

B4 command

This command allows to read the status of the Transparent Mode (enabled/disabled).

REQ:

Byte 0
0xB4

RES:

Byte 0	Byte 1
0xB4	Status

0x01 = Transparent Mode disabled

0x00 = Transparent Mode enabled

B5 command

This command allows to enable/disable the polling to a single Modbus slave.

REQ:

Byte 0	Byte 1	Byte 2
0xB5	Slave ID	0x00/0x01

0x01 = Disable polling for Modbus slave

0x00 = Enable polling for Modbus slave

If the message is received correctly, the same message will be sent back by the converter.

Example:

They are connected 3 Modbus slaves (Modbus IDs 1, 2, 3) to the converter and we want to stop the polling to the slave with ID = 2.

The message to send to the converter will be:

Byte 0	Byte 1	Byte 2
0xB5	0x02	0x01

B6 command

This command allows to enable/disable a single poll on Modbus side.

REQ:

Byte 0	Byte 1	Byte 2
0xB6	Poll No	0x00/0x01

0x01 = Disable poll

0x00 = Enable poll

If the message is received correctly, the same message will be sent back by the converter.

Example:

In the section "Set Access" are defined 3 Modbus reading requests and 3 Modbus writing requests.

We want to disable the first Modbus writing request (4th poll).

The message to send to the converter will be:

Byte 0	Byte 1	Byte 2
0xB6	0x04	0x01

MECHANICAL DIMENSIONS:

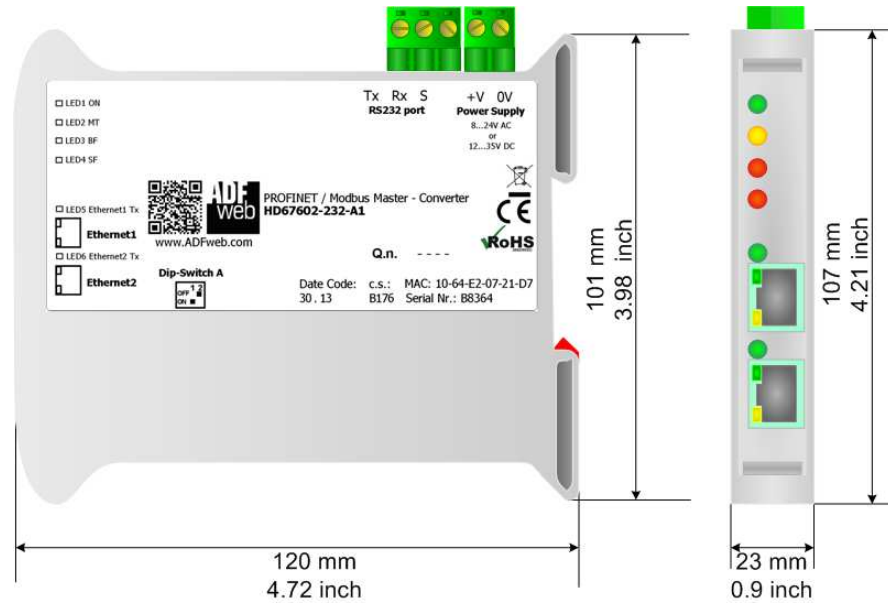

Housing: PVC
Weight: 200g (Approx)

Figure 8: Mechanical dimensions scheme for HD67602-232-A1

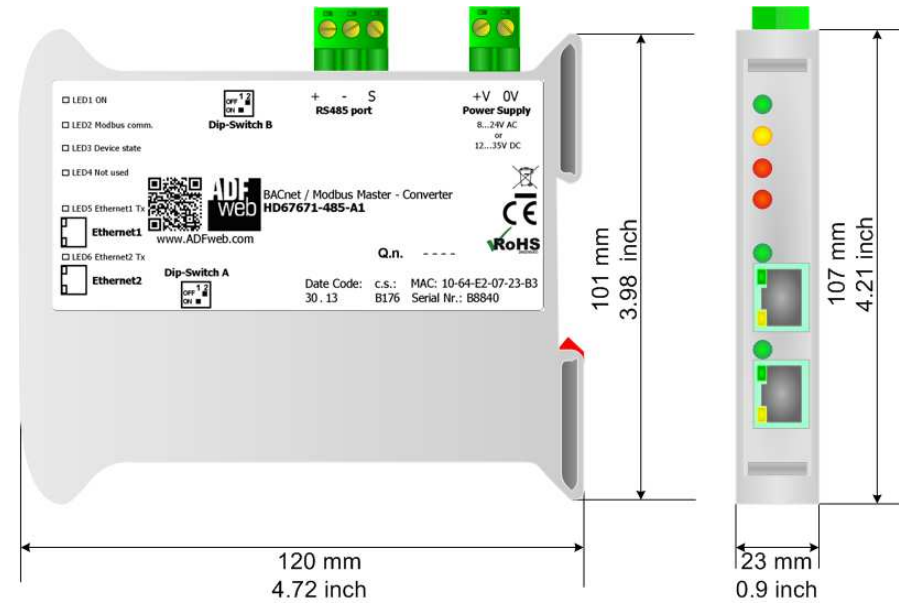

Housing: PVC
Weight: 200g (Approx)

Figure 9: Mechanical dimensions scheme for HD67602-485-A1

ORDERING INFORMATION:

The ordering part number is formed by a valid combination of the following:

HD67602 - 232 - A 1

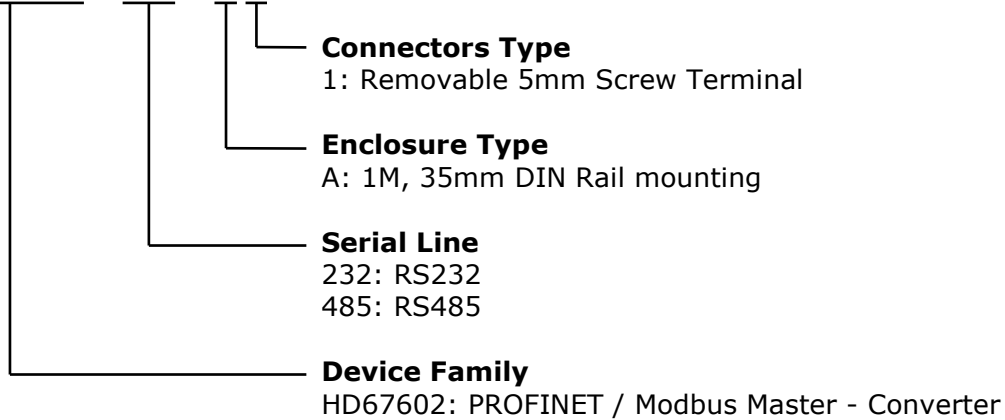

Order Code: **HD67602-232-A1** - Converter PROFINET / Modbus Master Converter (RS232 serial)

Order Code: **HD67602-485-A1** - Converter PROFINET / Modbus Master Converter (RS485 serial)

ACCESSORIES:

Order Code: **AC34001** - 35mm Rail DIN - Power Supply 220/240V AC 50/60Hz – 12 V AC

Order Code: **AC34002** - 35mm Rail DIN - Power Supply 110V AC 50/60Hz – 12 V AC

PLC CONFIGURATION:

The configuration and commissioning of the PROFINET Converter as described on the following pages was accomplished with the help of the TIA Portal V11-software by Siemens. In the case of using a control system from another supplier, refer to attend to the associated documentation.

These are the steps to follow:

- 1) Install the description file of the module.

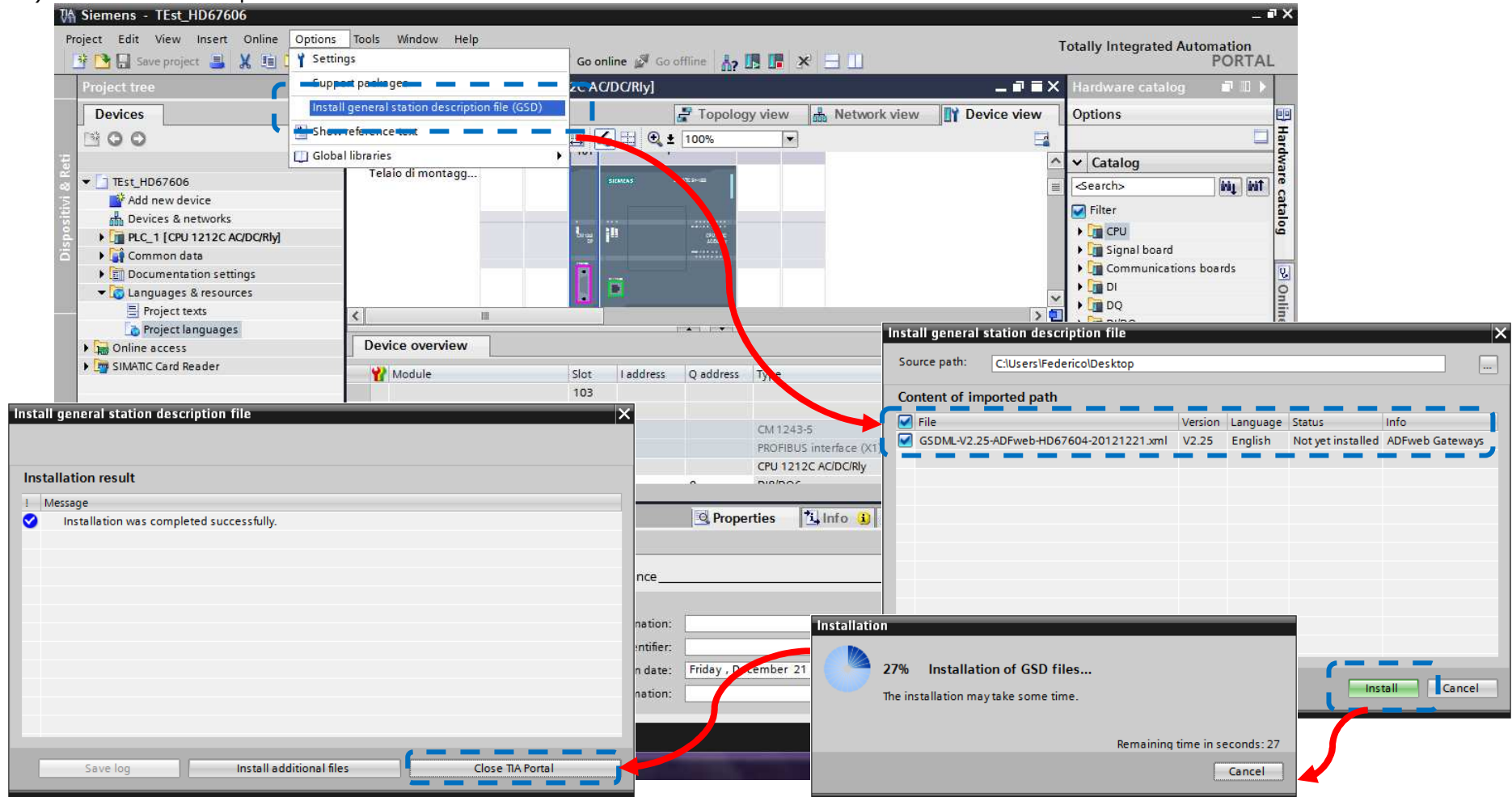

- 2) Press the “**Devices and networks**” button **(1)**, from the right drop-down menu, under “Other field devices→PROFINET IO→Gateway→ADFWEB.com→HD67602” double click on “Serial” module **(2)**.



Note:

If you have installed more than one xml file, go to the Information section and in the “Version” field select the correct xml file **(3)**, before double clicking on “Serial” module

Device	Type	Address in subnet	Subnet	Master system	Comr
SIMATIC 1200 station_1	SIMATIC 1200 station				
PLC_1	CPU 1212C AC/DC/Rly				
GSD device_1	GSD device				

- 3) Connect the PLC to the HD67602 module by drawing the Ethernet wire between the two Ethernet ports. Then assign the IP Address **(1)** defined in the Compositor_SW67602 to the HD67602. Then double click the "Module" **(2)**.

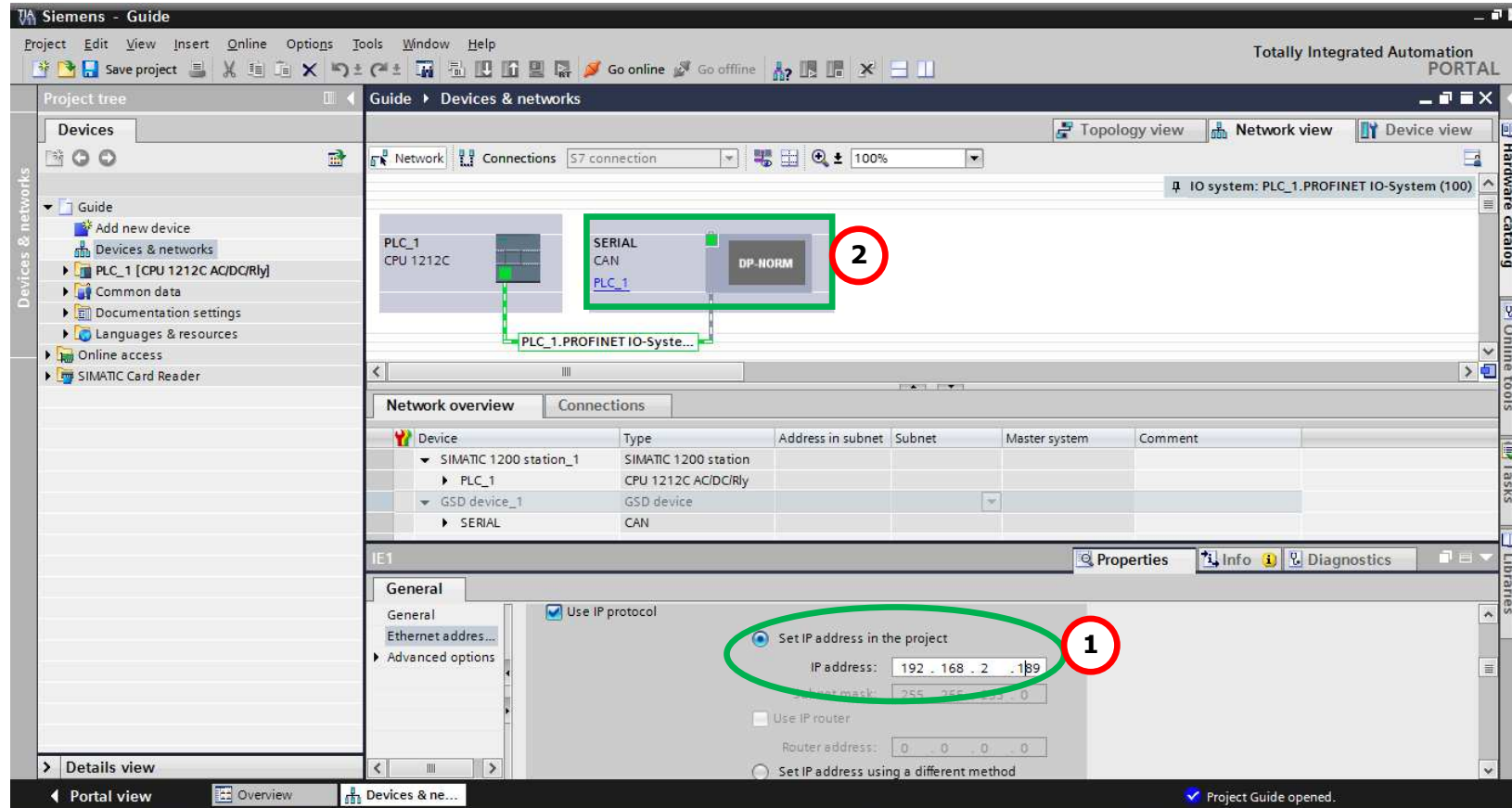

- 4) Then double click on the "Serial" label **(1)** and in the field name change it accordingly to the name defined in the Compositor_SW67602 **(2)**. Then add the main module "Module" and the sub-modules of "Digital Input" and "Digital Output" by double click on the three items in this order "Module" **(3)**, "Submodule 1" **(4)**, "Submodule 2" **(5)**.

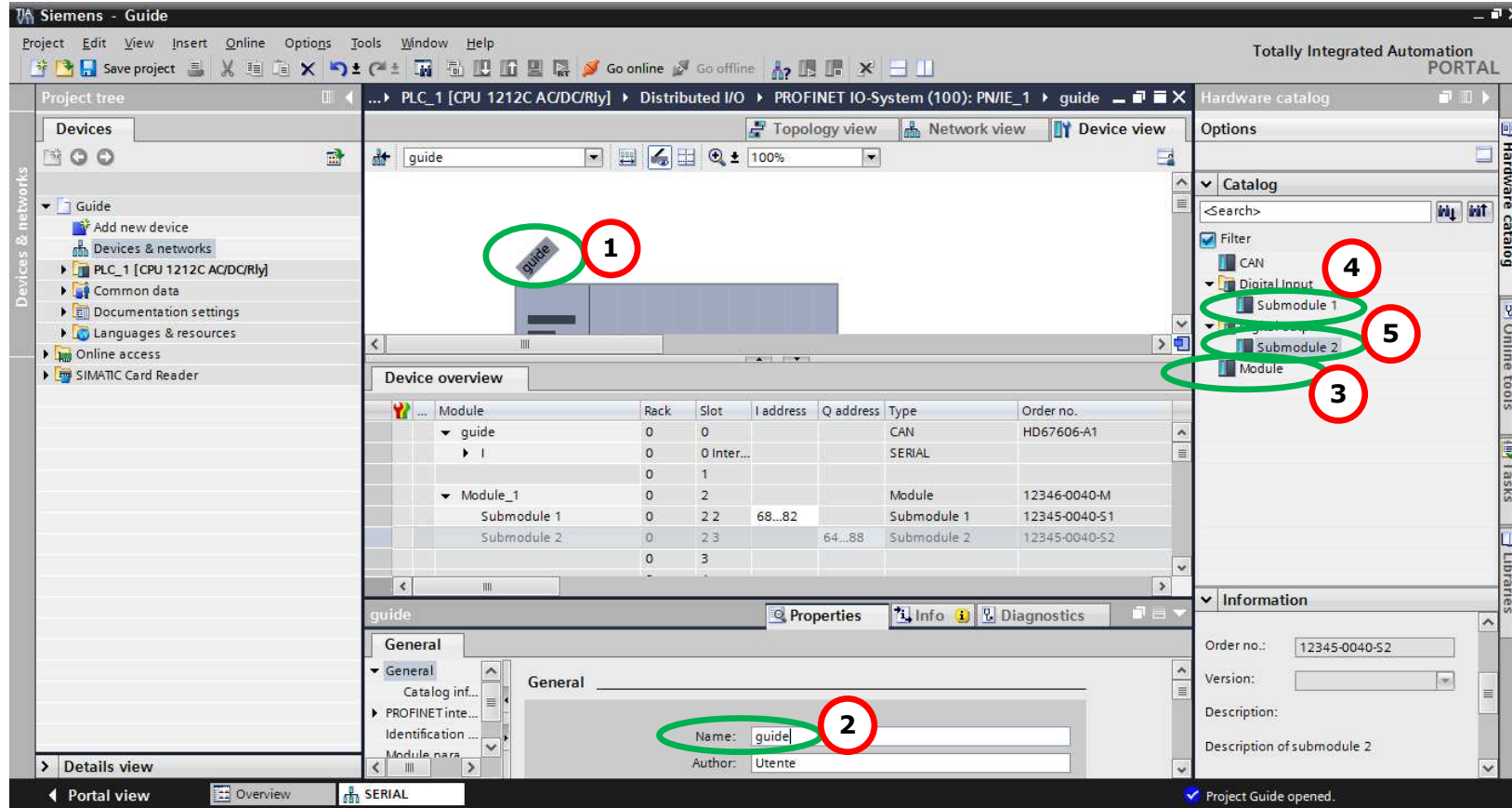

5) Load the configuration into the PLC.

Configured access nodes of "PLC_1"

Device	Device type	Type	Address	Subnet
PLC_1	CPU 1212C AC/D...	PN/IE	192.168.2.50	PN/IE_1
CM 1243-5	CM 1243-5	PROFIBUS	2	

Type of the PG/PC interface:

PG/PC interface:

Connection to subnet:

1st gateway:

Accessible devices in target subnet: Show all accessible devices

Device	Device type	Type	Address	Target device
PLC_1	CPU 1212C AC/D...	PN/IE	192.168.2.50	PLC_1
--	--	PN/IE	Access address	--

Flash LED

Online status information:
 Connected to address 192.168.2.50
 Scanning ended.

Buttons: Load, Cancel, Refresh

Load preview

Check before loading

Status	!	Target	Message	Action
<input checked="" type="checkbox"/>		PLC_1	Ready for loading.	
<input checked="" type="checkbox"/>		▶ Stop modules	All modules will be stopped for downloading to device.	Stop all
<input checked="" type="checkbox"/>		▶ Device configurati...	Delete and replace system data in target	Download to device
<input checked="" type="checkbox"/>		▶ Software	Download software to device	Consistent download
<input checked="" type="checkbox"/>		▶ Additional inform...	There are differences between the settings for the project and the se	<input checked="" type="checkbox"/> Overwrite all

Buttons: Refresh, Finish, Load, Cancel

DISCLAIMER:

All technical content within this document can be modified without notice. The content of the document is a under continual renewal. For losses due to fire, earthquake, third party access or other accidents, or intentional or accidental abuse, misuse, or use under abnormal conditions repairs are charged to the user. ADFweb.com S.r.l. will not be liable for accidental loss of use or inability to use this product, such as loss of business income. ADFweb.com S.r.l. shall not be liable for consequences of improper use.

OTHER REGULATIONS AND STANDARDS:**WEEE INFORMATION**

Disposal of old electrical and electronic equipment (as in the European Union and other European countries with separate collection systems).

— This symbol on the product or on its packaging indicates that this product may not be treated as household rubbish. Instead, it should be taken to an applicable collection point for the recycling of electrical and electronic equipment. If the product is disposed correctly, you will help prevent potential negative environmental factors and impact of human health, which could otherwise be caused by inappropriate disposal. The recycling of materials will help to conserve natural resources. For more information about recycling this product, please contact your local city office, your household waste disposal service or the shop where you purchased the product.

RESTRICTION OF HAZARDOUS SUBSTANCES DIRECTIVE

The device respects the 2002/95/EC Directive on the restriction of the use of certain hazardous substances in electrical and electronic equipment (commonly referred to as Restriction of Hazardous Substances Directive or RoHS).

CE MARKING

The product conforms with the essential requirements of the applicable EC directives.

WARRANTIES AND TECHNICAL SUPPORT:

For fast and easy technical support for your ADFweb.com SRL products, consult our internet support at www.adfweb.com.
Otherwise contact us at the address support@adfweb.com

RETURN POLICY:

If while using your product you have any problem and you wish to exchange or repair it, please do the following:

- Obtain a Product Return Number (PRN) from our internet support at www.adfweb.com. Together with the request, you need to provide detailed information about the problem.
- Send the product to the address provided with the PRN, having prepaid the shipping costs (shipment costs billed to us will not be accepted).

If the product is within the warranty of twelve months, it will be repaired or exchanged and returned within three weeks. If the product is no longer under warranty, you will receive a repair estimate.



ADFweb.com S.r.l.
Via Strada Nuova, 17
IT-31010 Marenò di Piave
TREVISO (Italy)
Phone +39.0438.30.91.31
Fax +39.0438.49.20.99
www.adfweb.com

