

User Manual

Revision 1.000

English

S7comm / Modbus Slave - Converter

(Order Code: HD67622-232-A1, HD67622-485-A1, HD67622-422-A1)

For Website information:

www.adfweb.com?Product=HD67622

For Price information:

www.adfweb.com?Price=HD67622-A1

Benefits and Main Features:

- ✦ Very easy to configure
- ✦ Triple Electrical isolation
- ✦ Temperature range: -40°C/+85°C (-40°F/+185°F)



For other S7comm products see also the following link:

S7comm from/to ...

www.adfweb.com?Product=HD67618
www.adfweb.com?Product=HD67619
www.adfweb.com?Product=HD67620
www.adfweb.com?Product=HD67621
www.adfweb.com?Product=HD67623
www.adfweb.com?Product=HD67624
www.adfweb.com?Product=HD67625
www.adfweb.com?Product=HD67626
www.adfweb.com?Product=HD67627
www.adfweb.com?Product=HD67628
www.adfweb.com?Product=HD67629
www.adfweb.com?Product=HD67630
www.adfweb.com?Product=HD67631
www.adfweb.com?Product=HD67632
www.adfweb.com?Product=HD67633

(Modbus TCP Slave)
(PROFIBUS Slave)
(IEC61850 Server)
(Serial)
(CAN)
(CANopen)
(DeviceNet Slave)
(SNMP Agent)
(EtherNet/IP Slave)
(KNX)
(MQTT)
(BACnet Slave)
(Ethernet)
(OPC UA Server)
(PROFINET Slave)

Do you have your customer protocol? Then go to:

www.adfweb.com?Product=HD67003

Do you need to choose a device? Do you want help?

www.adfweb.com?Cmd=helpme



User Manual

INDEX:

	Page
INDEX	2
UPDATED DOCUMENTATION	2
REVISION LIST	2
WARNING	2
TRADEMARKS	2
SECURITY ALERT	3
EXAMPLE OF CONNECTION	4
CONNECTION SCHEME	5
CHARACTERISTICS	8
CONFIGURATION	8
POWER SUPPLY	9
FUNCTION MODES	10
LEDS	11
RS232	12
RS485	13
RS422	14
ETHERNET	15
USE OF COMPOSITOR SW67622	16
NEW CONFIGURATION / OPEN CONFIGURATION	17
SOFTWARE OPTIONS	18
SET COMMUNICATION	20
S7COMM ACCESS	21
UPDATE DEVICE	25
MODBUS MAP	27
MECHANICAL DIMENSIONS	29
ORDERING INFORMATIONS	30
ACCESSORIES	30
DISCLAIMER	31
OTHER REGULATIONS AND STANDARDS	31
WARRANTIES AND TECHNICAL SUPPORT	32
RETURN POLICY	32

UPDATED DOCUMENTATION:

Dear customer, we thank you for your attention and we remind you that you need to check that the following document is:

- Updated
- Related to the product you own

To obtain the most recently updated document, note the “document code” that appears at the top right-hand corner of each page of this document.

With this “Document Code” go to web page www.adfweb.com/download/ and search for the corresponding code on the page. Click on the proper “Document Code” and download the updates.

REVISION LIST:

Revision	Date	Author	Chapter	Description
1.000	18/09/2021	Ff	All	First Release

WARNING:

ADFweb.com reserves the right to change information in this manual about our product without warning.
ADFweb.com is not responsible for any error this manual may contain.

TRADEMARKS:

All trademarks mentioned in this document belong to their respective owners.

SECURITY ALERT:**GENERAL INFORMATION**

To ensure safe operation, the device must be operated according to the instructions in the manual. When using the device, legal and safety regulation are required for each individual application. The same applies also when using accessories.

INTENDED USE

Machines and systems must be designed so the faulty conditions do not lead to a dangerous situation for the operator (i.e. independent limit switches, mechanical interlocks, etc.).

QUALIFIED PERSONNEL

The device can be used only by qualified personnel, strictly in accordance with the specifications. Qualified personnel are persons who are familiar with the installation, assembly, commissioning and operation of this equipment and who have appropriate qualifications for their job.

RESIDUAL RISKS

The device is state-of-the-art and is safe. The instruments can represent a potential hazard if they are inappropriately installed and operated by untrained personnel. These instructions refer to residual risks with the following symbol:



This symbol indicates that non-observance of the safety instructions is a danger for people that could lead to serious injury or death and / or the possibility of damage.

CE CONFORMITY

The declaration is made by our company. You can send an email to support@adfweb.com or give us a call if you need it.

EXAMPLES OF CONNECTION:

S7 comm / Modbus - Converter
HD67622-xxx-A1

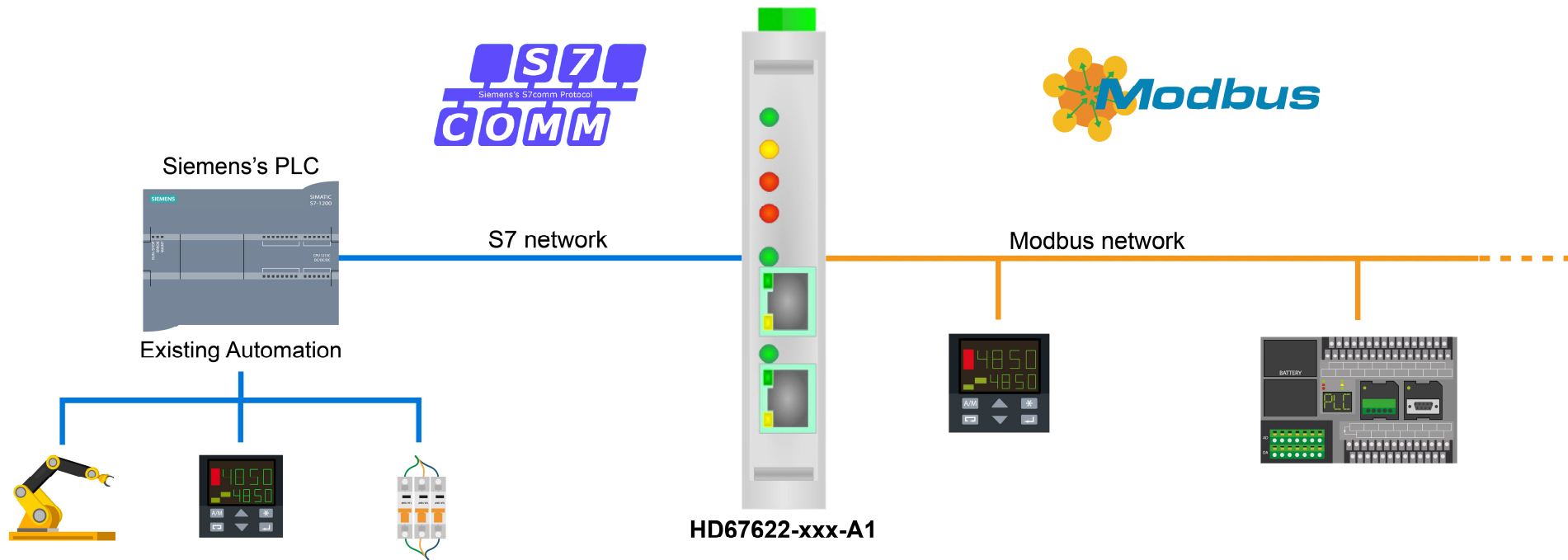

ADFweb.com



+39 0438 309 131



+39 349 440 9592



support@adfweb.com

CONNECTION SCHEME:

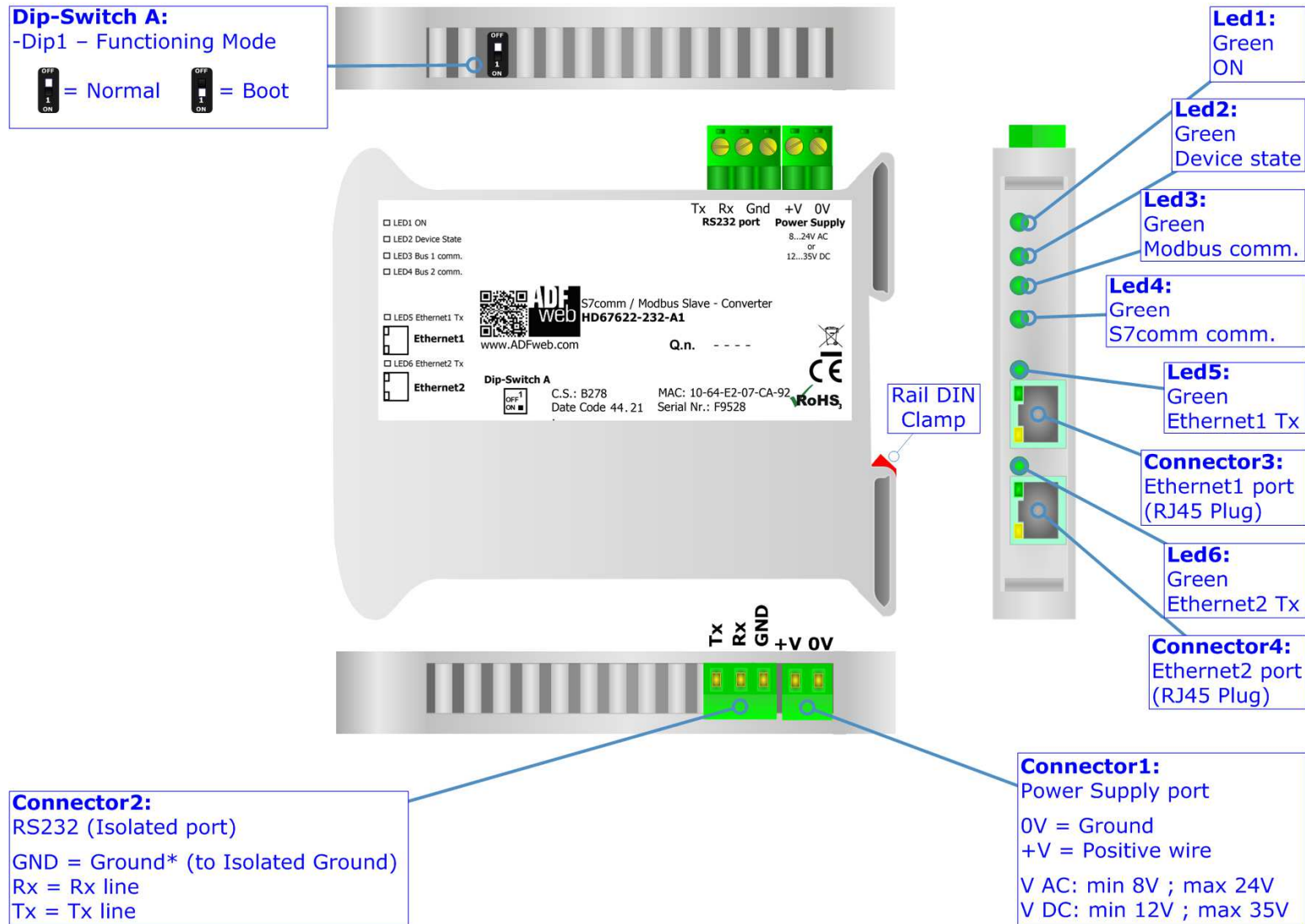

Figure 1a: Connection scheme for HD67622-232-A1

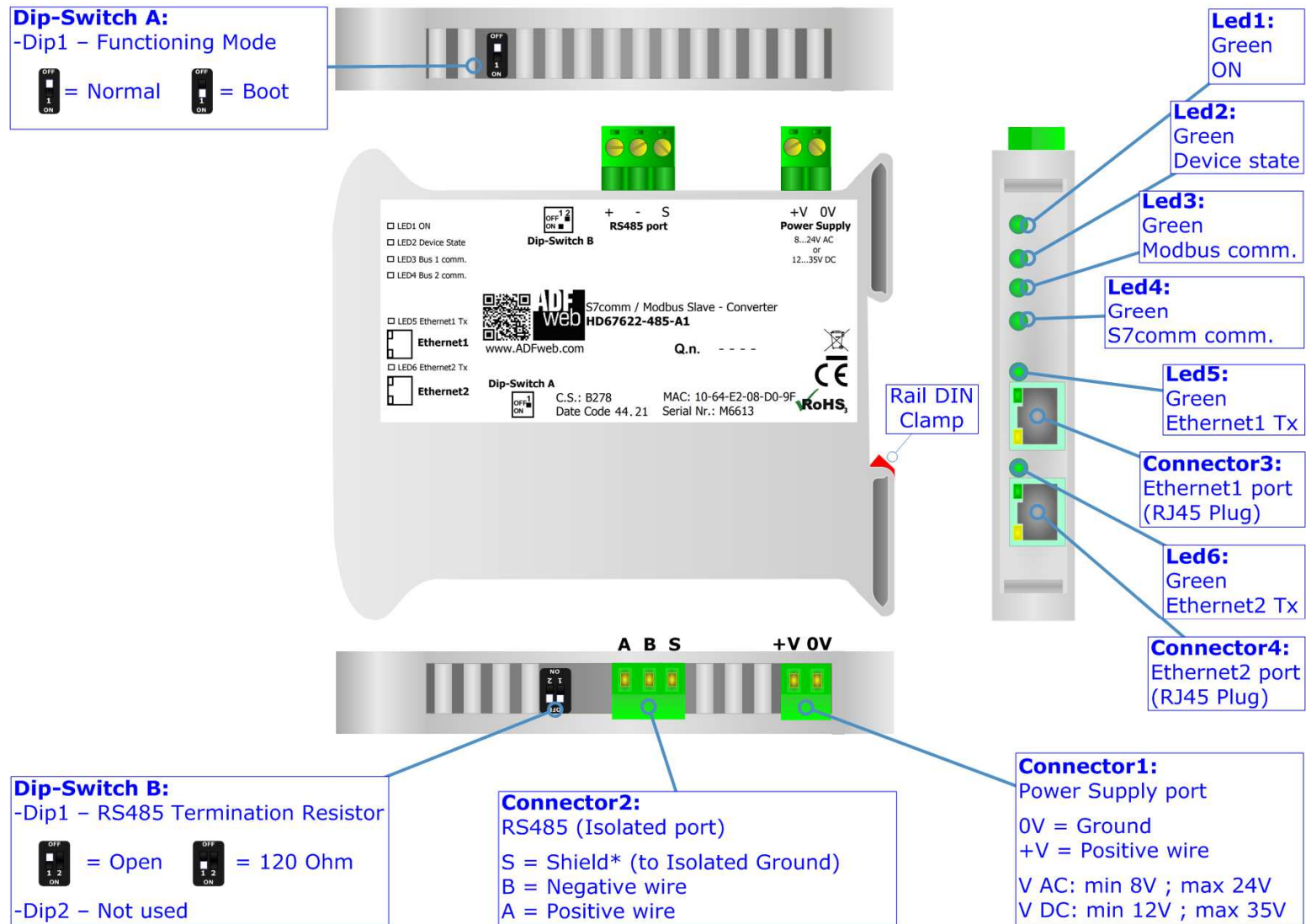

Figure 1b: Connection scheme for HD67622-485-A1

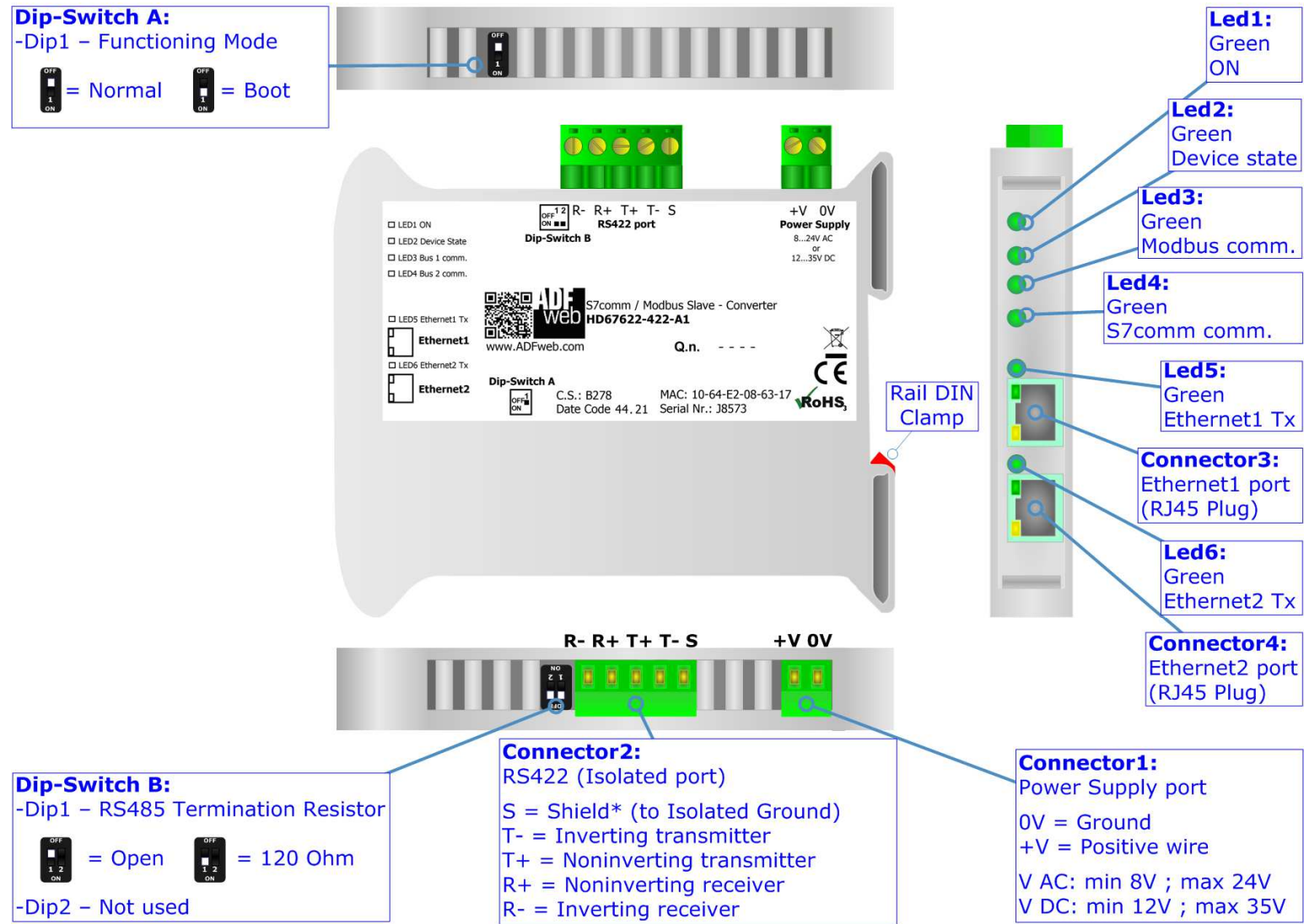

Figure 1c: Connection scheme for HD67622-422-A1

CHARACTERISTICS:

The HD67622-xxx-A1 is S7comm / Modbus Slave - Converter.

It allows for the following characteristics:

- Isolation between Ethernet – Serial - Power Supply;
- Two-directional information between Modbus bus and S7comm bus;
- Mountable on 35mm Rail DIN;
- Wide power supply input range: 8...24V AC or 12...35V DC;
- Wide temperature range: -40°C / 85°C [-40°F / +185°F].

CONFIGURATION:

You need Compositor SW67622 software on your PC in order to perform the following:

- Define the parameters of Modbus line;
- Define the parameters of S7comm line;
- Define the S7comm requests to send to the S7comm servers;
- Update the device.

POWER SUPPLY:

The devices can be powered at 8...24V AC and 12...35V DC. For more details see the two tables below.

VAC		VDC	
Vmin	Vmax	Vmin	Vmax
8V	24V	12V	35V

Consumption at 24V DC:

Device	Consumption [W/VA]
HD67622-xxx-A1	3.5

Connector1:
 Power Supply port
 0V = Ground
 +V = Positive wire
 V AC: min 8V ; max 24V
 V DC: min 12V ; max 35V

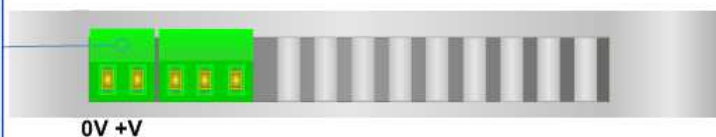

Caution: Do not reverse the polarity power

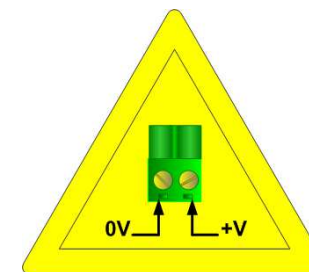

HD67622-xxx-A1

FUNCTION MODES:

The device has got two function modes depending on the position of the 'Dip1 of Dip-Switch A':

- The first, with 'Dip1 of Dip-Switch A' at "OFF" position, is used for the normal working of the device.
- The second, with 'Dip1 of Dip-Switch A' at "ON" position, is used for uploading the Project and/or Firmware.

For the operations to follow for the updating, see 'UPDATE DEVICE' section.

According to the functioning mode, the LEDs will have specific functions, see 'LEDS' section.

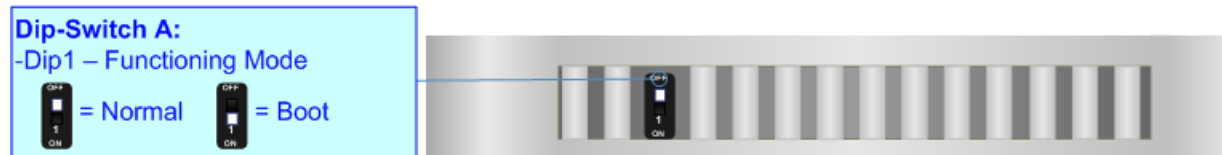

LEDS:

The device has got six LEDs that are used to give information about the functioning status.
The various meanings of the LEDs are described in the table below.

LED	Normal Mode	Boot Mode
1: ON [supply voltage] (green)	ON: Device powered OFF: Device not powered	ON: Device powered OFF: Device not powered
2: Device State (green)	Blinks slowly (~1Hz)	Blinks quickly: Boot state Blinks very slowly (~0.5Hz): update in progress
3: S7comm comm. (green)	It blinks when S7comm communication is running	Blinks quickly: Boot state Blinks very slowly (~0.5Hz): update in progress
4: Modbus comm. (green)	It blinks when Modbus communication is running	Blinks quickly: Boot state Blinks very slowly (~0.5Hz): update in progress
5: Ethernet1 Tx (green)	Blinks when is transmitting Ethernet frames	Blinks quickly: Boot state Blinks very slowly (~0.5Hz): update in progress
6: Ethernet2 Tx (green)	Blinks when is transmitting Ethernet frames	Blinks quickly: Boot state Blinks very slowly (~0.5Hz): update in progress

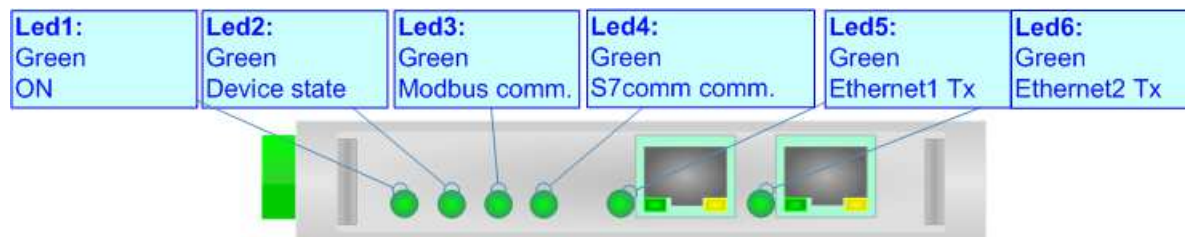

RS232:

The connection from RS232 socket to a serial port (example one from a personal computer) must be made with a Null Modem cable (a serial cable where the pins 2 and 3 are crossed).

It is recommended that the RS232 cable not exceed 15 meters.

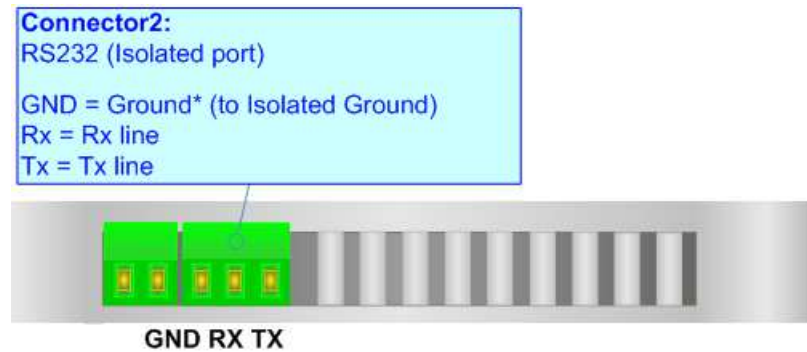

RS485:

For terminate the RS485 line with a 120Ω resistor it is necessary to put ON dip 1, like in figure.

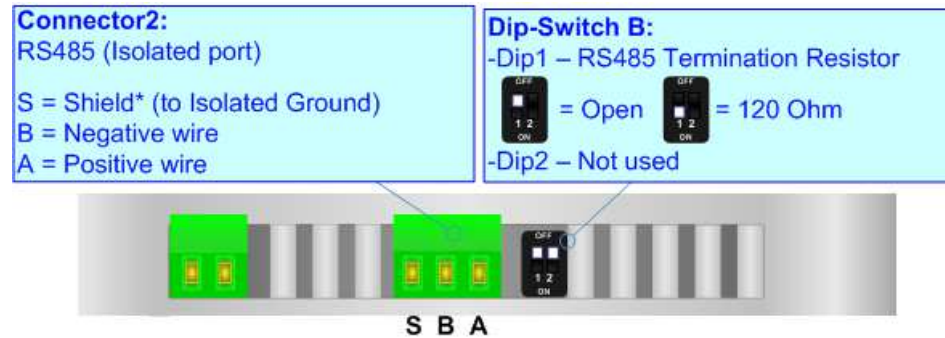

The maximum length of the cable should be 1200m (4000 feet).

Here some codes of cables:

- Belden: p/n 8132 - 2x 28AWG stranded twisted pairs conductor + foil shield + braid shield;
- Belden p/n 82842 - 2x 24AWG stranded twisted pairs conductor + foil shield + braid shield;
- Tasker: p/n C521 - 1x 24AWG twisted pair conductor + foil shield + braid shield;
- Tasker: p/n C522 - 2x 24AWG twisted pairs conductor + foil shield + braid shield.

RS422:

For terminate the RS422 line with a 120Ω resistor it is necessary to put ON dip 1 for T line and/or put ON dip 2 for R line, like in figure.

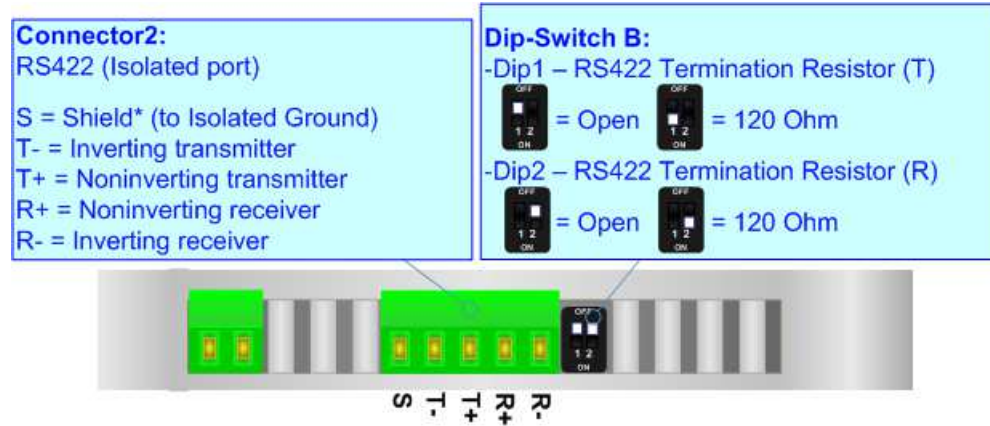

The maximum length of the cable should be 1200m (4000 feet).

ETHERNET:

S7comm connection and the updating of the converters must be made using Connector5 and/or Connector6 of the HD67622-xxx-A1 with at least a Category 5E cable. The maximum length of the cable should not exceed 100m. The cable has to conform to the T568 norms relative to connections in cat.5 up to 100 Mbps. To connect the device to an Hub/Switch is recommended the use of a straight cable, to connect the device to a PC/PLC/other is recommended the use of a cross cable.

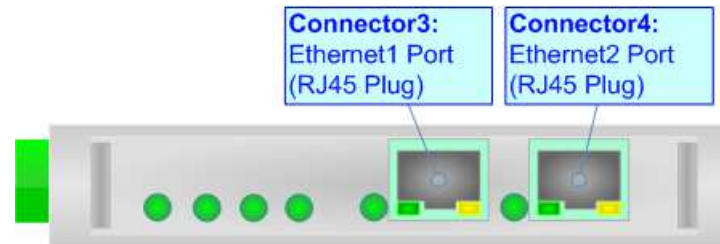

USE OF COMPOSITOR SW67622:

To configure the Converter, use the available software that runs with Windows called SW67622. It is downloadable on the site www.adfweb.com and its operation is described in this document. *(This manual is referenced to the last version of the software present on our web site)*. The software works with MSWindows (XP, Vista, Seven, 8, 10, 11; 32/64bit).

When launching the SW67622, the window below appears (Fig. 2).



Note:

It is necessary to have installed .Net Framework 4.

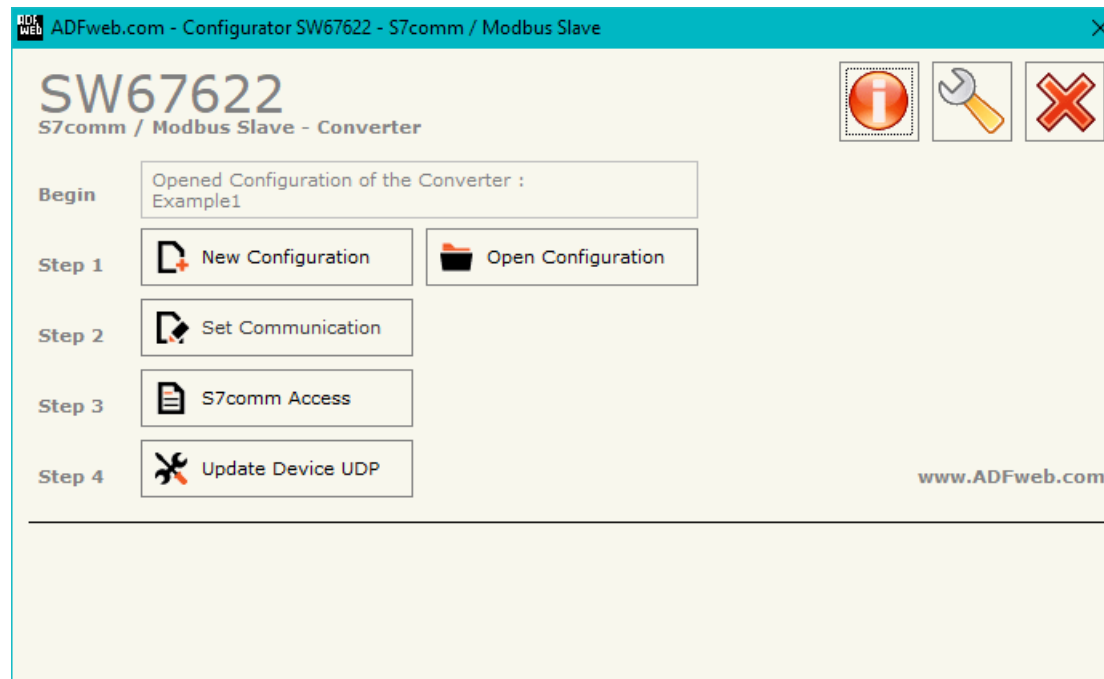
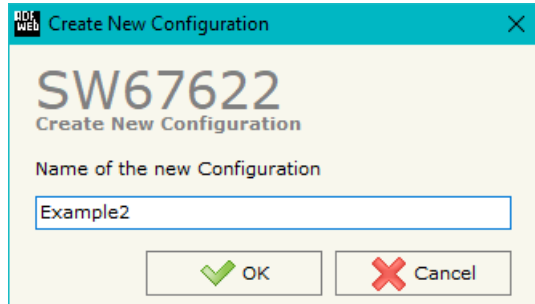

Figure 2: Main window for SW67622

NEW CONFIGURATION / OPEN CONFIGURATION:

The “**New Configuration**” button creates the folder which contains the entire device’s configuration.



A device’s configuration can also be imported or exported:

- To clone the configurations of a programmable “S7comm / Modbus Slave - Converter” in order to configure another device in the same manner, it is necessary to maintain the folder and all its contents;
- To clone a project in order to obtain a different version of the project, it is sufficient to duplicate the project folder with another name and open the new folder with the button “**Open Configuration**”.

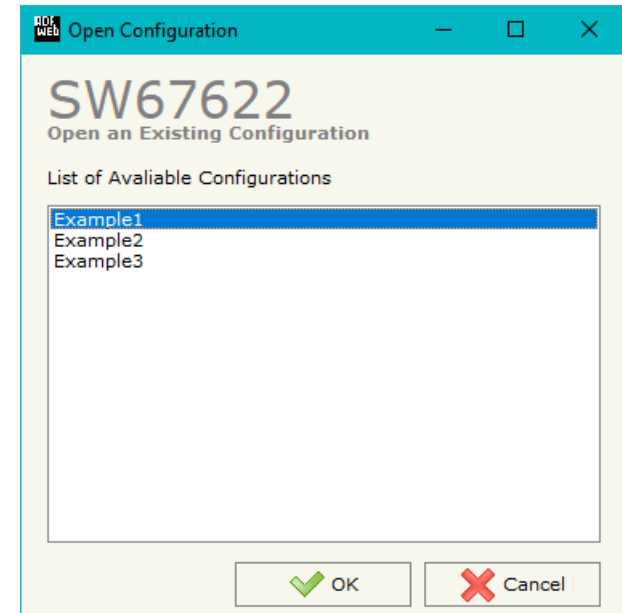

SOFTWARE OPTIONS:

By pressing the “**Settings**” () button there is the possibility to change the language of the software and check the updatings for the compositor.

In the section “Language” it is possible to change the language of the software.

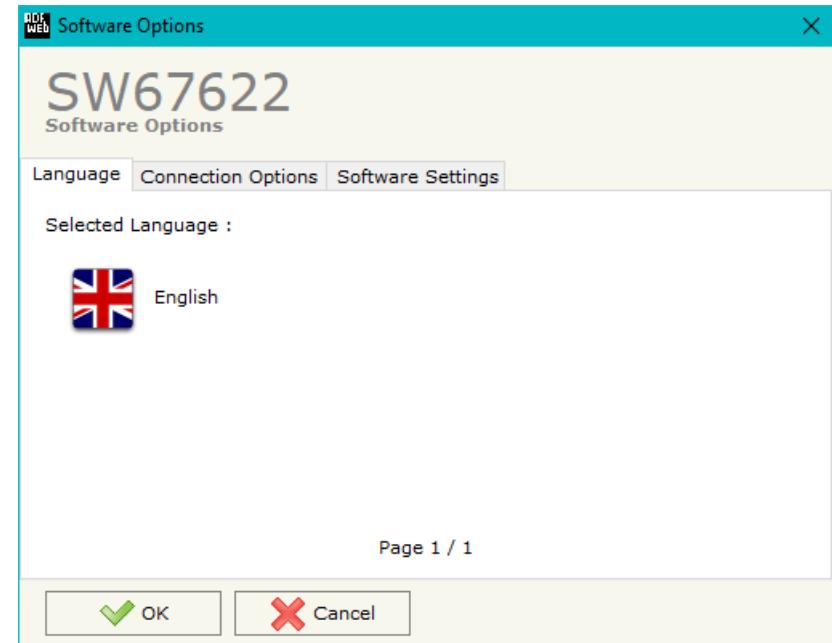
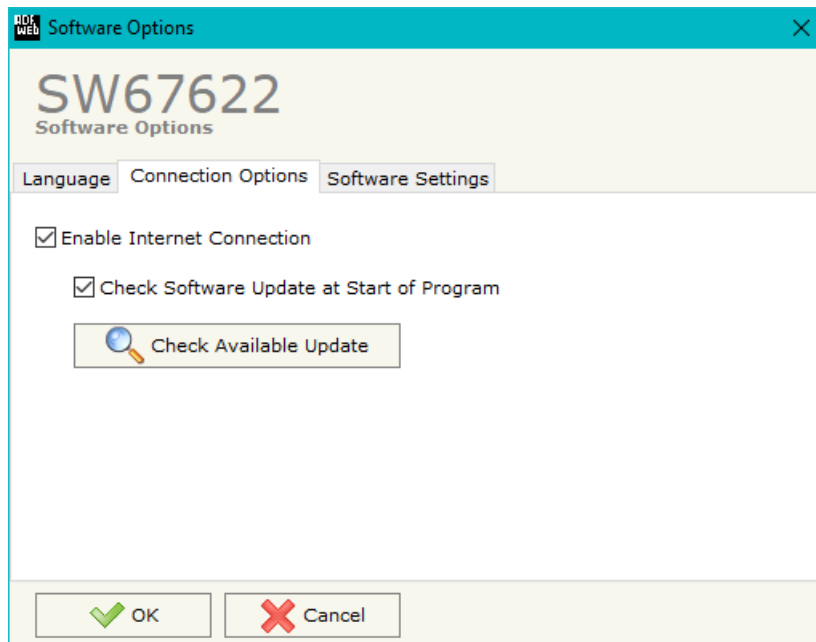

In the section “Connection Options”, it is possible to check if there are some updatings of the software compositor in ADFweb.com website. Checking the option “**Check Software Update at Start of Program**”, the SW67622 checks automatically if there are updatings when it is launched.

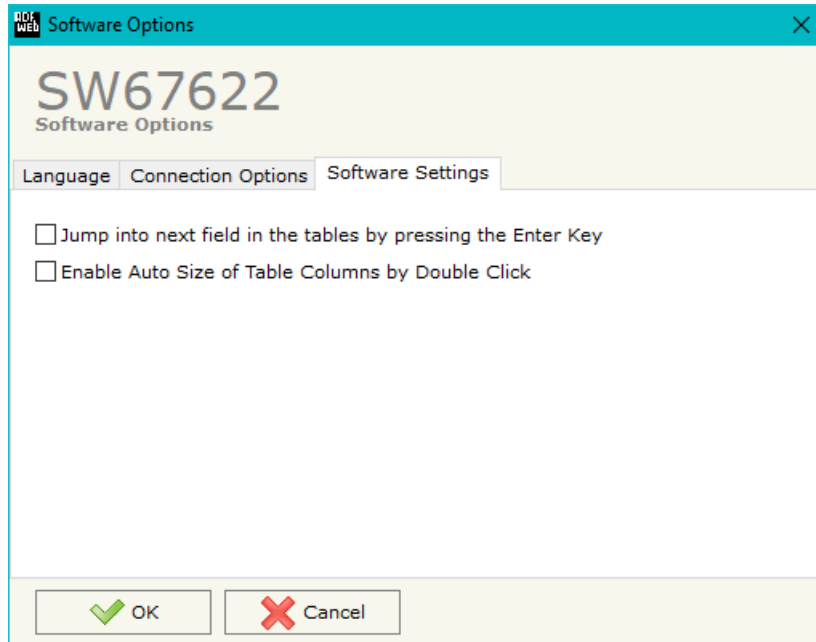

In the section "Software Settings", it is possible to enable/disable some keyboard's commands for an easier navigation inside the tables contained in the different sections of the software.

SET COMMUNICATION:

This section defines the fundamental communication parameter of two buses, S7comm and Modbus.

By pressing the **"Set Communication"** button from the main window of SW67622 (Fig. 2) the window "Set Communication" appears (Fig. 3).

The means of the fields for "S7comm" are:

- In the fields **"IP ADDRESS"** the IP address for S7comm side of the converter is defined;
- In the fields **"SUBNET Mask"** the SubNet Mask for S7comm side of the converter is defined;
- In the fields **"GATEWAY"** the default gateway of the net is defined. This feature can be enabled or disabled pressing the Check Box field. This feature is used for going out of the net.

The means of the fields for the "Modbus Slave" section are:

- In the field **"Serial"** the type of serial port used is defined;
- In the field **"Baudrate"** the baud rate for Modbus side is defined;
- In the field **"Parity"** the parity for Modbus side is defined;
- In the field **"Stop Bits"** the number of Stop Bit is defined;
- In the field **"Device ID"** the ID of Modbus side is defined;
- If the field **"Read with Input Register / Status Function"** is checked, it is possible to read the Input bytes of S7comm side with Input Registers (Function 04) and write the Output bytes of S7comm side with Holding Registers (Function 06/16). The Output bytes are readable with Function 03. Otherwise, only Holding Registers will be used and the Output bytes of S7comm side cannot be read back.

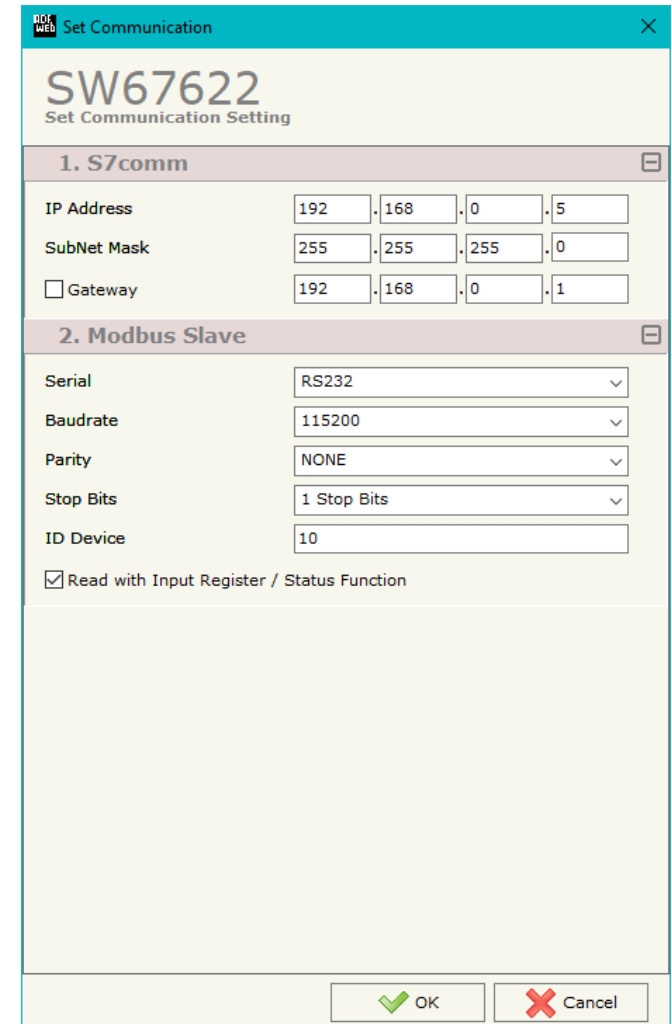

1. S7comm	
IP Address	192 . 168 . 0 . 5
SubNet Mask	255 . 255 . 255 . 0
<input type="checkbox"/> Gateway	192 . 168 . 0 . 1
2. Modbus Slave	
Serial	RS232
Baudrate	115200
Parity	NONE
Stop Bits	1 Stop Bits
ID Device	10
<input checked="" type="checkbox"/> Read with Input Register / Status Function	

Figure 3: "Set Communication" window

S7COMM ACCESS:

By Pressing the “**S7comm Access**” button from the main window of SW67622 (Fig. 2), the window “Set S7comm Access” appears (Fig. 4). The window is divided in two parts, the “**S7comm Read**” that contains the data that the converter reads from the S7comm servers and “**S7comm Write**” that contains the data that the converter writes into the S7comm servers.

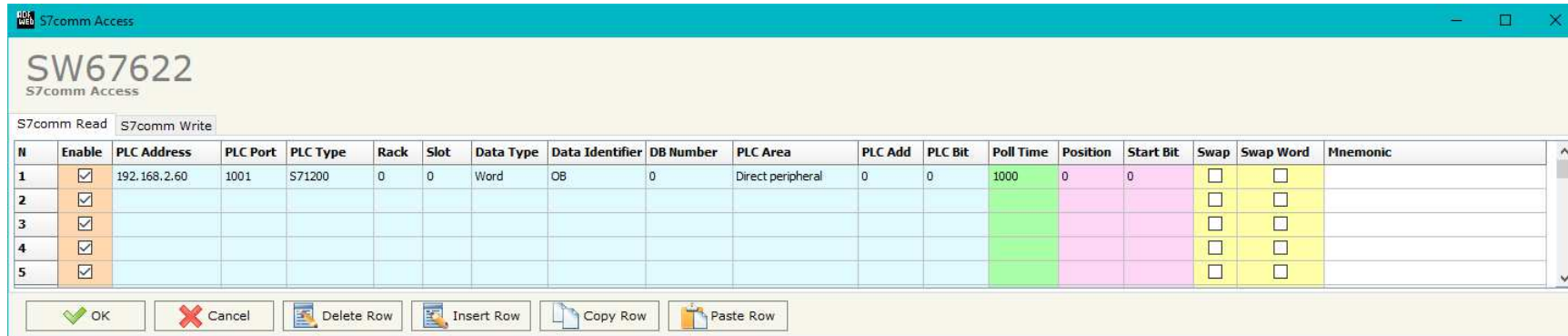

Figure 4a: “S7comm Access → S7comm Read” window

The means of the fields in the window “S7comm Read” are the following:

- In the field “**PLC Address**” the IP address of the PLC that contains the data to be read is defined;
- In the field “**PLC Port**” the port used for S7comm communication is defined;
- In the field “**PLC Type**” the family of the PLC is defined;
- In the field “**Rack**” the Rack’s ID of the PLC is defined;
- In the field “**Slot**” the Slot’s ID is defined;
- In the field “**Data Type**” the data format of the variable to read is defined;
- In the field “**Data Identifier**” the identifier of the variable to read is defined;
- In the field “**DB Number**” the number of the DB of the PLC to read is defined;
- In the field “**PLC Area**” the memory area where the data is located inside the PLC is defined;
- In the field “**PLC Add**” the starting memory address where the data is located is defined;
- In the field “**PLC Bit**” the starting bit of the selected PLC Address is defined;
- In the field “**Poll Time**” the frequency of the request is defined (in ms);

- In the field "**Position**" the starting byte of the internal memory array from which mapping the data read is defined;
- In the field "**Start Bit**" is used for the "Bit" data. It is possible to select the bit of the selected Position where mapping the data;
- If the field "**Swap**" is checked, the bytes' order is reversed;
- If the field "**Swap Word**" is checked, the words' order is reversed;
- In the field "**Mnemonic**" a description of the data inserted in the row is defined.

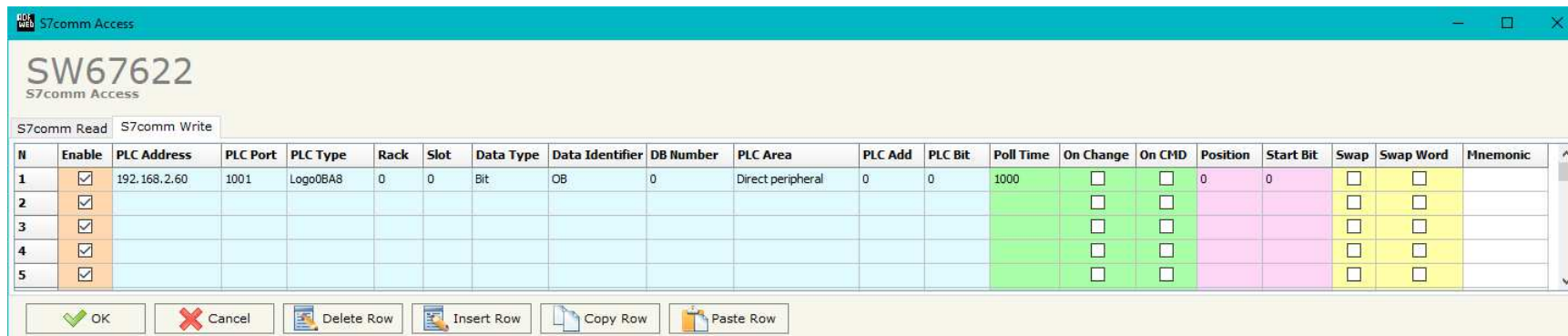

Figure 4b: "S7comm Access → S7comm Write" window

The means of the fields in the window "S7comm Write" are the following:

- In the field "**PLC Address**" the IP address of the PLC that contains the data to be read is defined;
- In the field "**PLC Port**" the port used for S7comm communication is defined;
- In the field "**PLC Type**" the family of the PLC is defined;
- In the field "**Rack**" the Rack's ID of the PLC is defined;
- In the field "**Slot**" the Slot's ID is defined;
- In the field "**Data Type**" the data format of the variable to write is defined;
- In the field "**Data Identifier**" the identifier of the variable to write is defined;
- In the field "**DB Number**" the number of the DB of the PLC to write is defined;
- In the field "**PLC Area**" the memory area where the data is located inside the PLC is defined;
- In the field "**PLC Add**" the starting memory address where the data is located is defined;
- In the field "**PLC Bit**" the starting bit of the selected PLC Address is defined;
- In the field "**Poll Time**" the frequency of the request is defined (in ms);
- By checking the field "**On Change**" the S7comm write request is sent only if Modbus data are changed;
- By checking the field "**On CMD**" the S7comm write request is sent when a Modbus writing for the selected variable is received;
- In the field "**Position**" the starting byte of the internal memory array from which taking the data to write is defined;
- The field "**Start Bit**" is used for the "Bit" data. It is possible to select the bit of the selected Position from which taking the data;
- If the field "**Swap**" is checked, the bytes' order is reversed;

- If the field "**Swap W**" is checked, the words' order is reversed;
- In the field "**Mnemonic**" a description of the data inserted in the row is defined.

UPDATE DEVICE:

By pressing the **“Update Device”** button, it is possible to load the created Configuration into the device; and also the Firmware, if necessary. This by using the Ethernet port.

If you don't know the actual IP address of the device you have to use this procedure:

- Turn OFF the Device;
- Put Dip1 of 'Dip-Switch A' in ON position;
- Turn ON the device
- Connect the Ethernet cable;
- Insert the IP **“192.168.2.205”**;
- Select which operations you want to do;
- Press the **“Execute update firmware”** button to start the upload;
- When all the operations are “OK” turn OFF the Device;
- Put Dip1 of 'Dip-Switch A' in OFF position;
- Turn ON the device.

If you know the actual IP address of the device, you have to use this procedure:

- Turn ON the Device with the Ethernet cable inserted;
- Insert the actual IP of the Converter;
- Select which operations you want to do;
- Press the **“Execute update firmware”** button to start the upload;
- When all the operations are “OK” the device automatically goes at Normal Mode.

At this point the configuration/firmware on the device is correctly updated.

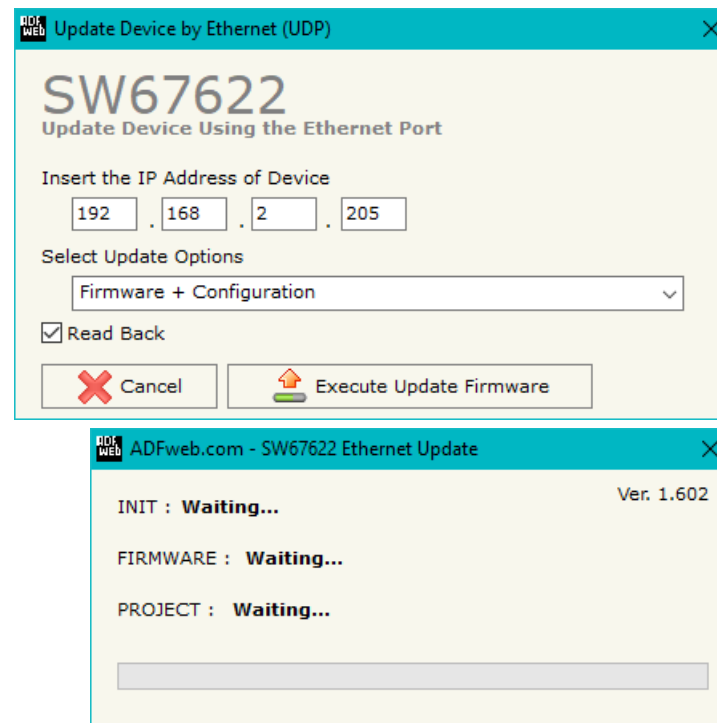

Figure 5: “Update device” windows



Note:

When you receive the device, for the first time, you also have to update the Firmware in the HD67622 device.



Warning:

If Fig. 6 appears when you try to do the Update try these points before seeking assistance:

- Try to repeat the operations for the updating;
- Try with another PC;
- Try to restart the PC;
- Check the LAN settings;
- If you are using the program inside a Virtual Machine, try to use in the main Operating System;
- If you are using Windows Seven, Vista, 8, 10 or 11 make sure that you have the administrator privileges;
- In case you have to program more than one device, using the "UDP Update", you have to cancel the ARP table every time you connect a new device on Ethernet. For do this you have to launch the "Command Prompt" and write the command "arp -d". Pay attention that with Windows Vista, Seven, 8, 10, 11 you have to launch the "Command Prompt" with Administrator Rights;
- Pay attention at Firewall lock.

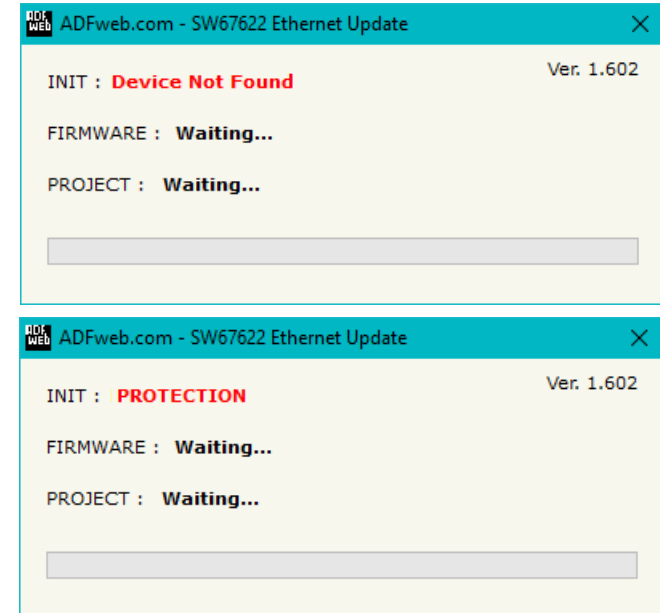

Figure 6: "Error" window



Warning:

In the case of HD67622 you have to use the software "SW67622": www.adfweb.com/download/filefold/SW67622.zip.

MODBUS MAP:

On Modbus side, the map is created automatically. In relation to the configuration defined, it is possible to have two different maps.

Read with Input Register / Status Function not enabled

Data in reading:

Type	Address	Function	Description
Holding Register	0	03	Input Bytes 0-1 of S7comm side
Holding Register	1	03	Input Bytes 2-3 of S7comm side
Holding Register	2	03	Input Bytes 4-5 of S7comm side
.			
.			
Holding Register	749	03	Input Bytes 1498-1499 of S7comm side

Data in writing:

Type	Address	Function	Description
Holding Register	0	06/16	Output Bytes 0-1 of S7comm side
Holding Register	1	06/16	Output Bytes 2-3 of S7comm side
Holding Register	2	06/16	Output Bytes 4-5 of S7comm side
.			
.			
Holding Register	749	06/16	Output Bytes 1498-1499 of S7comm side



Note:

The data can be read/written as single bits too using Coil Status (Function 01 and Functions 05/15).

Read with Input Register / Status Function enabled

Data in reading:

Type	Address	Function	Description
Input Register	0	04	Input Bytes 0-1 of S7comm side
Input Register	1	04	Input Bytes 2-3 of S7comm side
Input Register	2	04	Input Bytes 4-5 of S7comm side
.			
.			
Input Register	749	04	Input Bytes 1498-1499 of S7comm side

Data in writing:

Type	Address	Function	Description
Holding Register	0	R: 03 W: 06/16	Output Bytes 0-1 of S7comm side
Holding Register	1	R: 03 W: 06/16	Output Bytes 2-3 of S7comm side
Holding Register	2	R: 03 W: 06/16	Output Bytes 4-5 of S7comm side
.			
.			
Holding Register	749	R: 03 W: 06/16	Output Bytes 1498-1499 of S7comm side



Note:

The data can be read/written as single bits too using Input/Coil Status (Function 02 and Functions 01/05/15).

MECHANICAL DIMENSIONS:

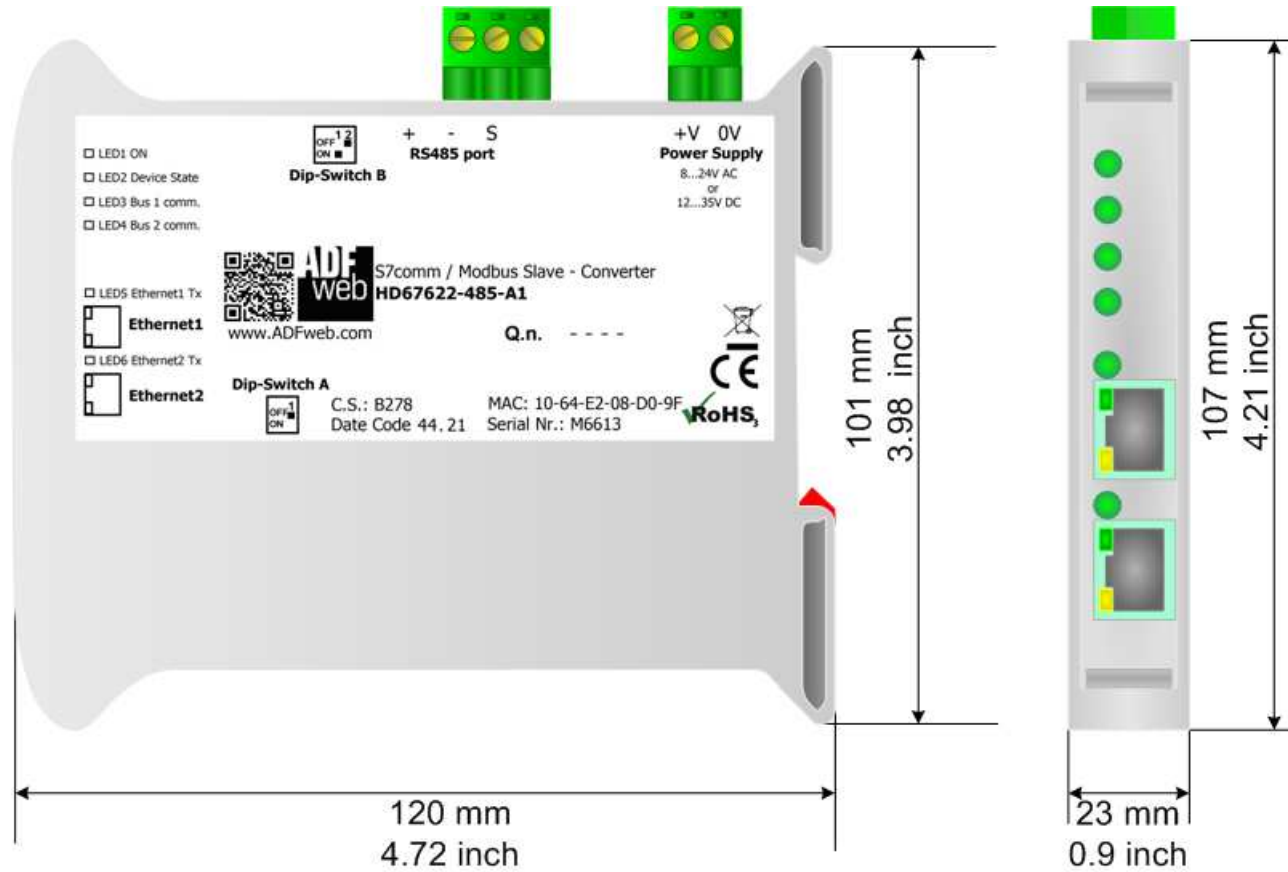

Housing: PVC
Weight: 200g (Approx)

Figure 7: Mechanical dimensions scheme for HD67622-xxx-A1

ORDERING INFORMATIONS:

The ordering part number is formed by a valid combination of the following:

HD67622 - xxx - A 1

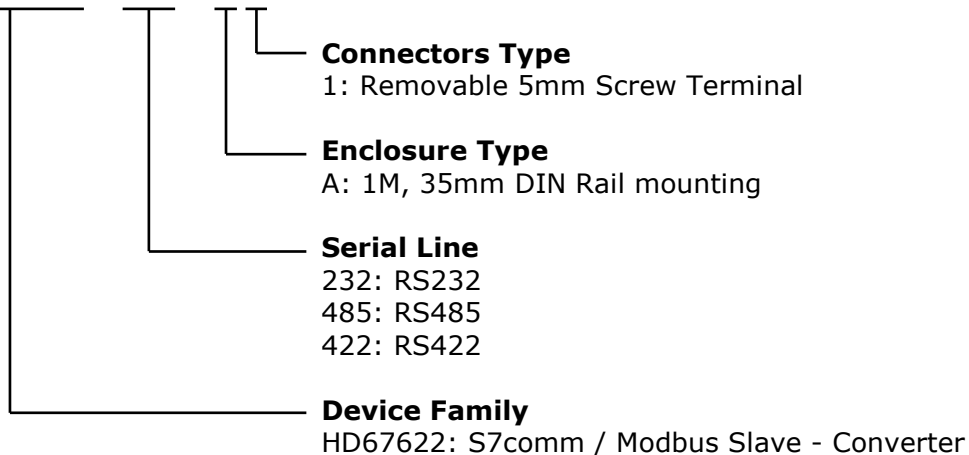

Order Code: **HD67622-232-A1** - Converter S7comm / Modbus Slave - Converter (RS232 serial)

Order Code: **HD67622-485-A1** - Converter S7comm / Modbus Slave - Converter (RS485 serial)

Order Code: **HD67622-422-A1** - Converter S7comm / Modbus Slave - Converter (RS422 serial)

ACCESSORIES:

Order Code: **AC34011** - 35mm Rail DIN - Power Supply 220/240V AC 50/60Hz – 12 V DC

Order Code: **AC34012** - 35mm Rail DIN - Power Supply 220/240V AC 50/60Hz – 24 V DC

DISCLAIMER:

All technical content within this document can be modified without notice. The content of the document is a under continual renewal. For losses due to fire, earthquake, third party access or other accidents, or intentional or accidental abuse, misuse, or use under abnormal conditions repairs are charged to the user. ADFweb.com S.r.l. will not be liable for accidental loss of use or inability to use this product, such as loss of business income. ADFweb.com S.r.l. shall not be liable for consequences of improper use.

OTHER REGULATIONS AND STANDARDS:**WEEE INFORMATION**

Disposal of old electrical and electronic equipment (as in the European Union and other European countries with separate collection systems).

— This symbol on the product or on its packaging indicates that this product may not be treated as household rubbish. Instead, it should be taken to an applicable collection point for the recycling of electrical and electronic equipment. If the product is disposed correctly, you will help prevent potential negative environmental factors and impact of human health, which could otherwise be caused by inappropriate disposal. The recycling of materials will help to conserve natural resources. For more information about recycling this product, please contact your local city office, your household waste disposal service or the shop where you purchased the product.

RESTRICTION OF HAZARDOUS SUBSTANCES DIRECTIVE

The device respects the 2002/95/EC Directive on the restriction of the use of certain hazardous substances in electrical and electronic equipment (commonly referred to as Restriction of Hazardous Substances Directive or RoHS).

CE MARKING

The product conforms with the essential requirements of the applicable EC directives.

WARRANTIES AND TECHNICAL SUPPORT:

For fast and easy technical support for your ADFweb.com SRL products, consult our internet support at www.adfweb.com. Otherwise contact us at the address support@adfweb.com

RETURN POLICY:

If while using your product you have any problem and you wish to exchange or repair it, please do the following:

- Obtain a Product Return Number (PRN) from our internet support at www.adfweb.com. Together with the request, you need to provide detailed information about the problem.
- Send the product to the address provided with the PRN, having prepaid the shipping costs (shipment costs billed to us will not be accepted).

If the product is within the warranty of twelve months, it will be repaired or exchanged and returned within three weeks. If the product is no longer under warranty, you will receive a repair estimate.



ADFweb.com S.r.l.
 Via Strada Nuova, 17
 IT-31010 Mareno di Piave
 TREVISO (Italy)
 Phone +39.0438.30.91.31
 Fax +39.0438.49.20.99
www.adfweb.com

