

# User Manual

Revision 1.001  
English

## BACnet slave / CANopen - Converter

(Order Code: HD67678-IP-A1, HD67678-MSTP-A1,  
HD67678-MSTP-B2, HD67678-PTP-A1,  
HD67678-PTP-B2)

For Website information:

[www.adfweb.com?Product=HD67678](http://www.adfweb.com?Product=HD67678)

For Price information:

[www.adfweb.com?Price=HD67678-IP-A1](http://www.adfweb.com?Price=HD67678-IP-A1)  
[www.adfweb.com?Price=HD67678-MSTP-A1](http://www.adfweb.com?Price=HD67678-MSTP-A1)  
[www.adfweb.com?Price=HD67678-MSTP-B2](http://www.adfweb.com?Price=HD67678-MSTP-B2)  
[www.adfweb.com?Price=HD67678-PTP-A1](http://www.adfweb.com?Price=HD67678-PTP-A1)  
[www.adfweb.com?Price=HD67678-PTP-B2](http://www.adfweb.com?Price=HD67678-PTP-B2)

### Benefits and Main Features:

- ⊕ Very easy to configure
- ⊕ Triple Electrical isolation
- ⊕ CANopen Client and Server
- ⊕ Temperature range: -40°C/+85°C (-40°F/+185°F)

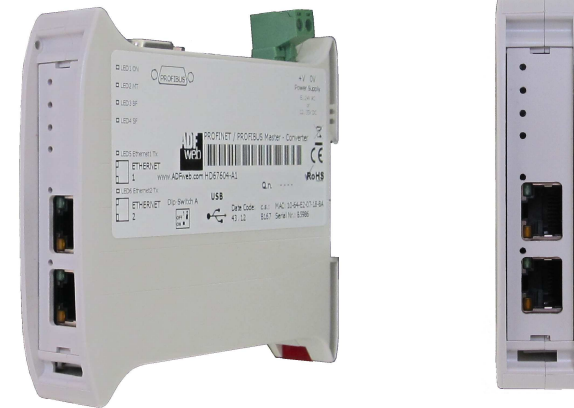

For others BACnet products see also the following link:

#### Converter BACnet slave to

[www.adfweb.com?Product=HD67056](http://www.adfweb.com?Product=HD67056)  
[www.adfweb.com?Product=HD67671](http://www.adfweb.com?Product=HD67671)  
[www.adfweb.com?Product=HD67672](http://www.adfweb.com?Product=HD67672)  
[www.adfweb.com?Product=HD67673](http://www.adfweb.com?Product=HD67673)  
[www.adfweb.com?Product=HD67674](http://www.adfweb.com?Product=HD67674)  
[www.adfweb.com?Product=HD67675](http://www.adfweb.com?Product=HD67675)  
[www.adfweb.com?Product=HD67676](http://www.adfweb.com?Product=HD67676)  
[www.adfweb.com?Product=HD67677](http://www.adfweb.com?Product=HD67677)  
[www.adfweb.com?Product=HD67679](http://www.adfweb.com?Product=HD67679)  
[www.adfweb.com?Product=HD67680](http://www.adfweb.com?Product=HD67680)  
[www.adfweb.com?Product=HD67681](http://www.adfweb.com?Product=HD67681)  
[www.adfweb.com?Product=HD67682](http://www.adfweb.com?Product=HD67682)  
[www.adfweb.com?Product=HD67683](http://www.adfweb.com?Product=HD67683)  
[www.adfweb.com?Product=HD67684](http://www.adfweb.com?Product=HD67684)

**(M-Bus Master)**  
**(Modbus Master)**  
**(Modbus Slave)**  
**(Modbus TCP Master)**  
**(Modbus TCP Slave)**  
**(PROFIBUS Master)**  
**(PROFIBUS Slave)**  
**(CAN)**  
**(PROFINET)**  
**(DeviceNet Master)**  
**(DeviceNet Slave)**  
**(EtherNet/IP)**  
**(NMEA 2000)**  
**(Ethernet)**

Do you have your customer protocol? Then go to:

[www.adfweb.com?Product=HD67003](http://www.adfweb.com?Product=HD67003)

Do you need to choose a device? Do you want help?

[www.adfweb.com?Cmd=helpme](http://www.adfweb.com?Cmd=helpme)



User Manual

**INDEX:**

	Page
INDEX	2
UPDATED DOCUMENTATION	2
REVISION LIST	2
WARNING	2
TRADEMARKS	2
SECURITY ALERT	3
EXAMPLE OF CONNECTION	4
CONNECTION SCHEME	7
CHARACTERISTICS	12
CONFIGURATION	12
POWER SUPPLY	13
FUNCTION MODES	14
LEDS (for HD67678-IP-A1)	15
LEDS (for HD67678-MSTP-A1/B2 and HD67678-PTP-A1/B2)	16
RS485 (for HD67678-MSTP-A1/B2)	17
RS232 (for HD67678-PTP-A1/B2)	18
ETHERNET	18
CANOPEN	19
USE OF COMPOSITOR SW67678	20
NEW CONFIGURATION / OPEN CONFIGURATION	21
SOFTWARE OPTIONS	22
SET COMMUNICATION	23
SET SDO SERVER	26
SET SDO CLIENT	27
SET PDO ACCESS	29
SET BACNET ACCESS	32
OBJECTS MAP	33
UPDATE DEVICE	34
MECHANICAL DIMENSIONS	36
ORDERING INFORMATIONS	39
ACCESSORIES	39
DISCLAIMER	40
OTHER REGULATIONS AND STANDARDS	40
WARRANTIES AND TECHNICAL SUPPORT	41
RETURN POLICY	41

**UPDATED DOCUMENTATION:**

Dear customer, we thank you for your attention and we remind you that you need to check that the following document is:

- ✚ Updated
- ✚ Related to the product you own

To obtain the most recently updated document, note the “document code” that appears at the top right-hand corner of each page of this document.

With this “Document Code” go to web page [www.adfweb.com/download/](http://www.adfweb.com/download/) and search for the corresponding code on the page. Click on the proper “Document Code” and download the updates.

**REVISION LIST:**

Revision	Date	Author	Chapter	Description
1.000	15/02/2013	Ff	All	First Release
1.001	08/06/2015	Fl	All	Revision

**WARNING:**

ADFweb.com reserves the right to change information in this manual about our product without warning. ADFweb.com is not responsible for any error this manual may contain.

**TRADEMARKS:**

All trademarks mentioned in this document belong to their respective owners.

**SECURITY ALERT:****GENERAL INFORMATION**

To ensure safe operation, the device must be operated according to the instructions in the manual. When using the device, legal and safety regulation are required for each individual application. The same applies also when using accessories.

**INTENDED USE**

Machines and systems must be designed so the faulty conditions do not lead to a dangerous situation for the operator (i.e. independent limit switches, mechanical interlocks, etc.).

**QUALIFIED PERSONNEL**

The device can be used only by qualified personnel, strictly in accordance with the specifications. Qualified personnel are persons who are familiar with the installation, assembly, commissioning and operation of this equipment and who have appropriate qualifications for their job.

**RESIDUAL RISKS**

The device is state-of-the-art and is safe. The instruments can represent a potential hazard if they are inappropriately installed and operated by untrained personnel. These instructions refer to residual risks with the following symbol:



This symbol indicates that non-observance of the safety instructions is a danger for people that could lead to serious injury or death and / or the possibility of damage.

**CE CONFORMITY**

The declaration is made by our company. You can send an email to [support@adfweb.com](mailto:support@adfweb.com) or give us a call if you need it.

**EXAMPLES OF CONNECTION:**

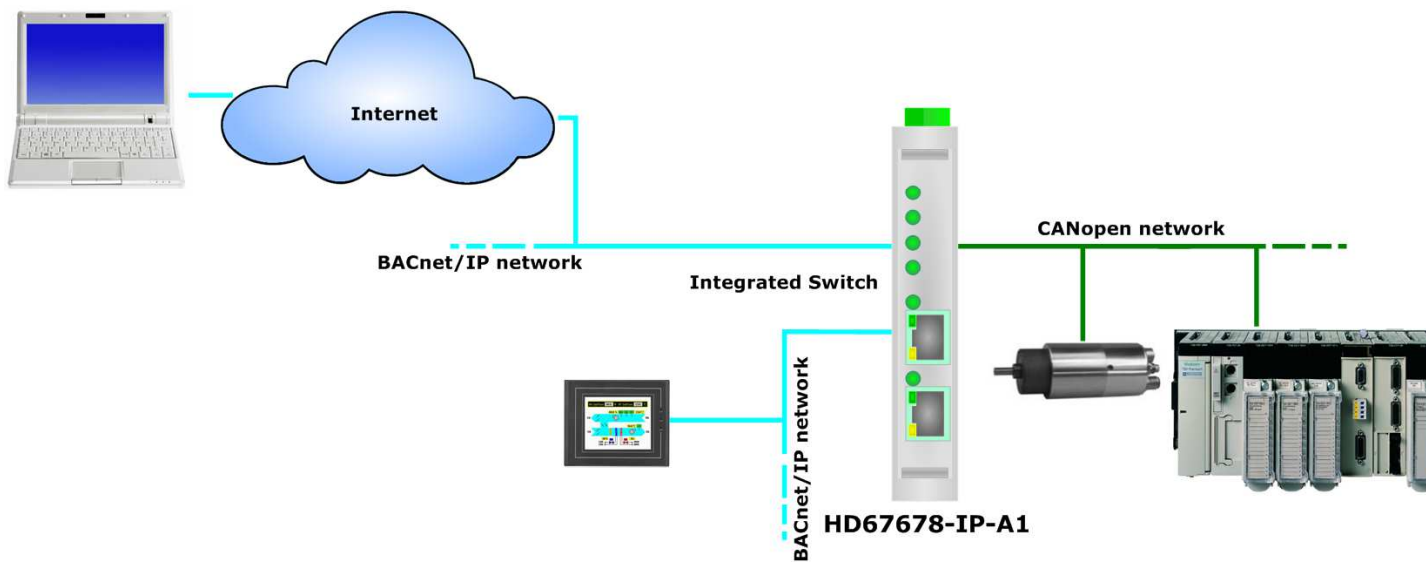
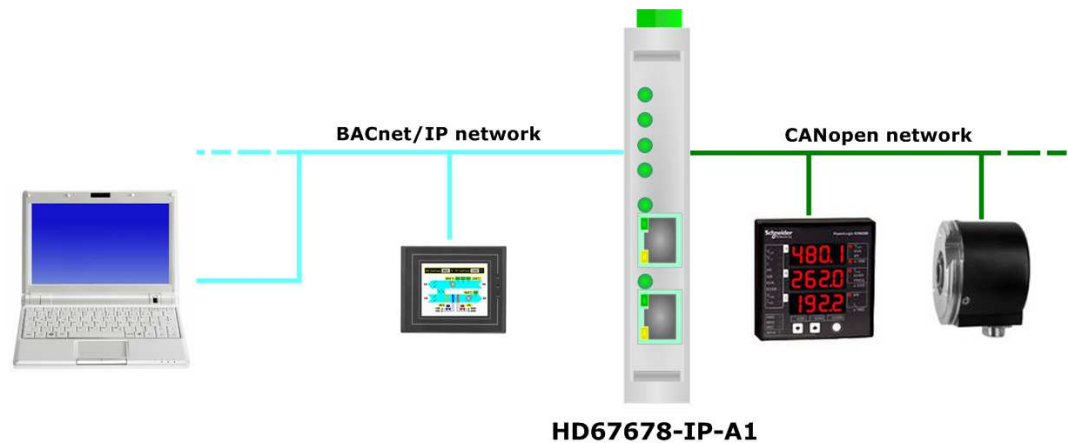

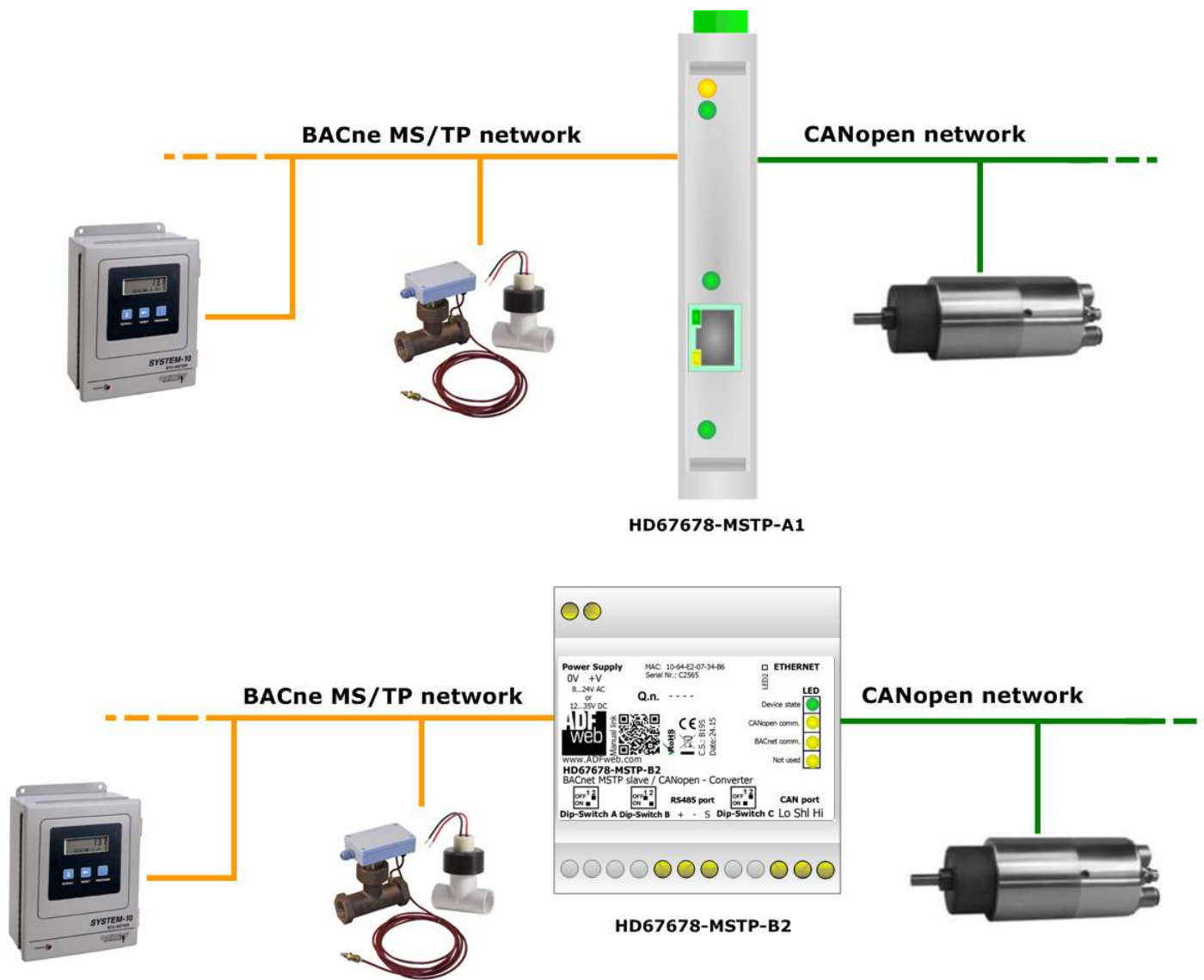

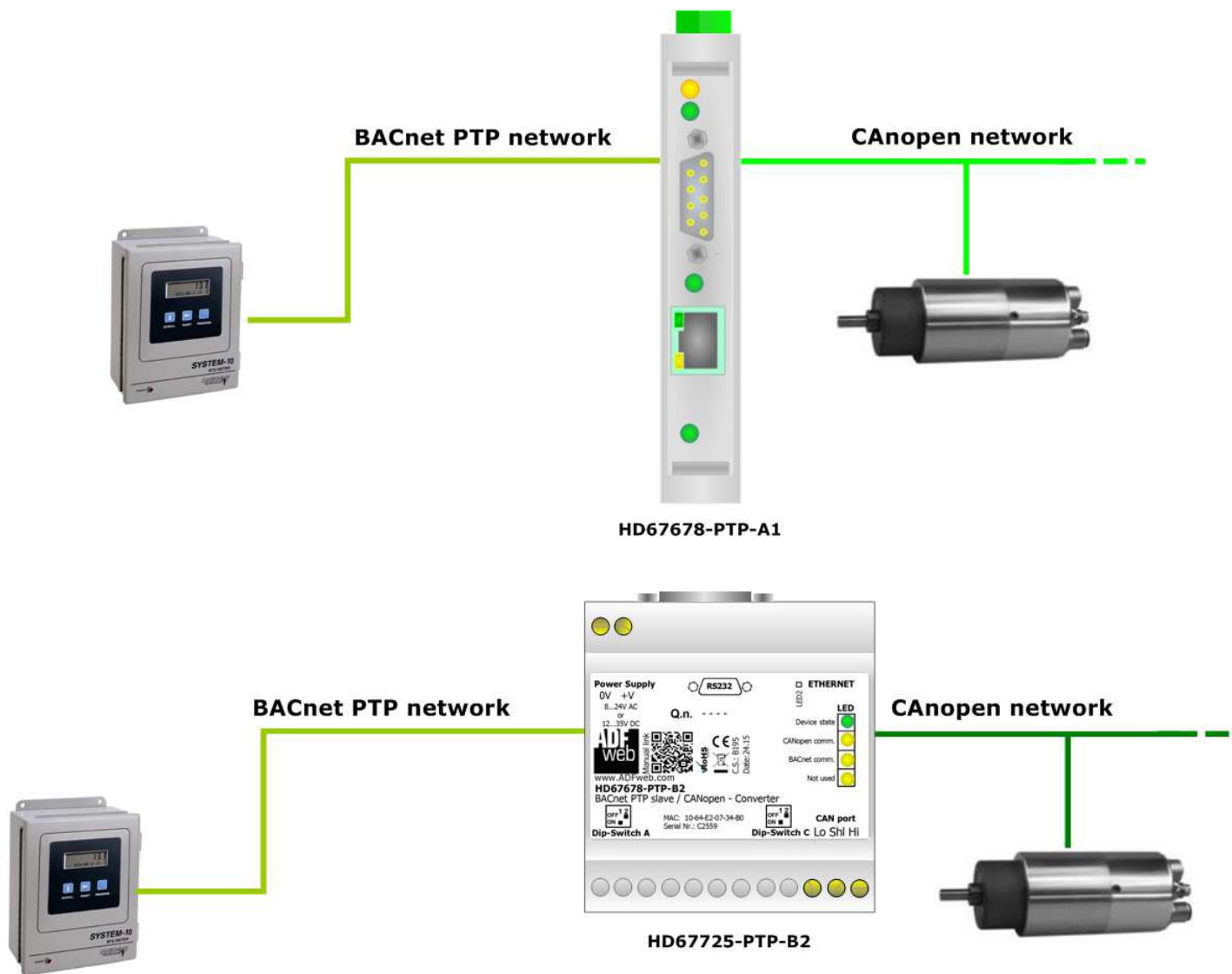

**CONNECTION SCHEME:**

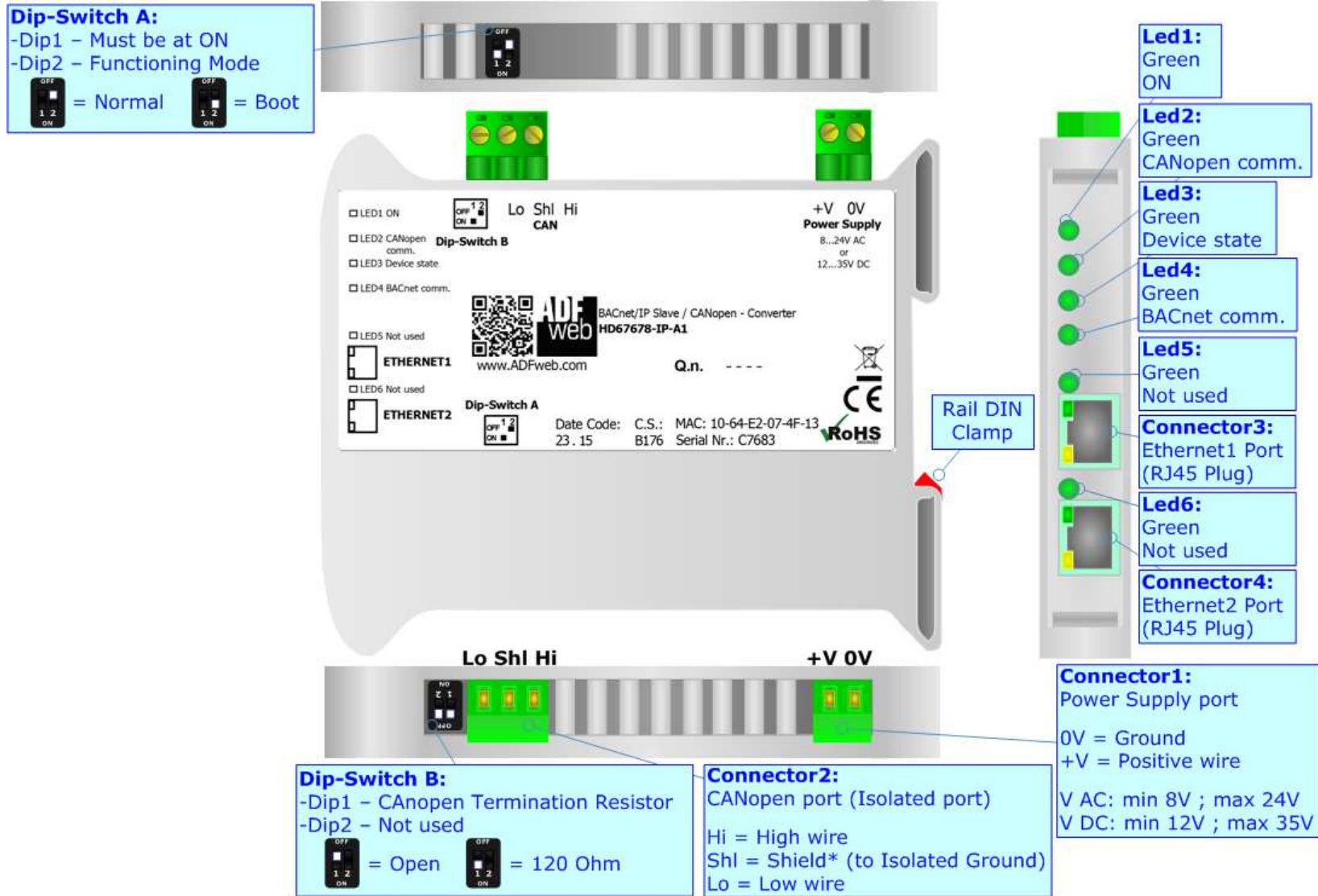

Figure 1a: Connection scheme for HD67678-IP-A1



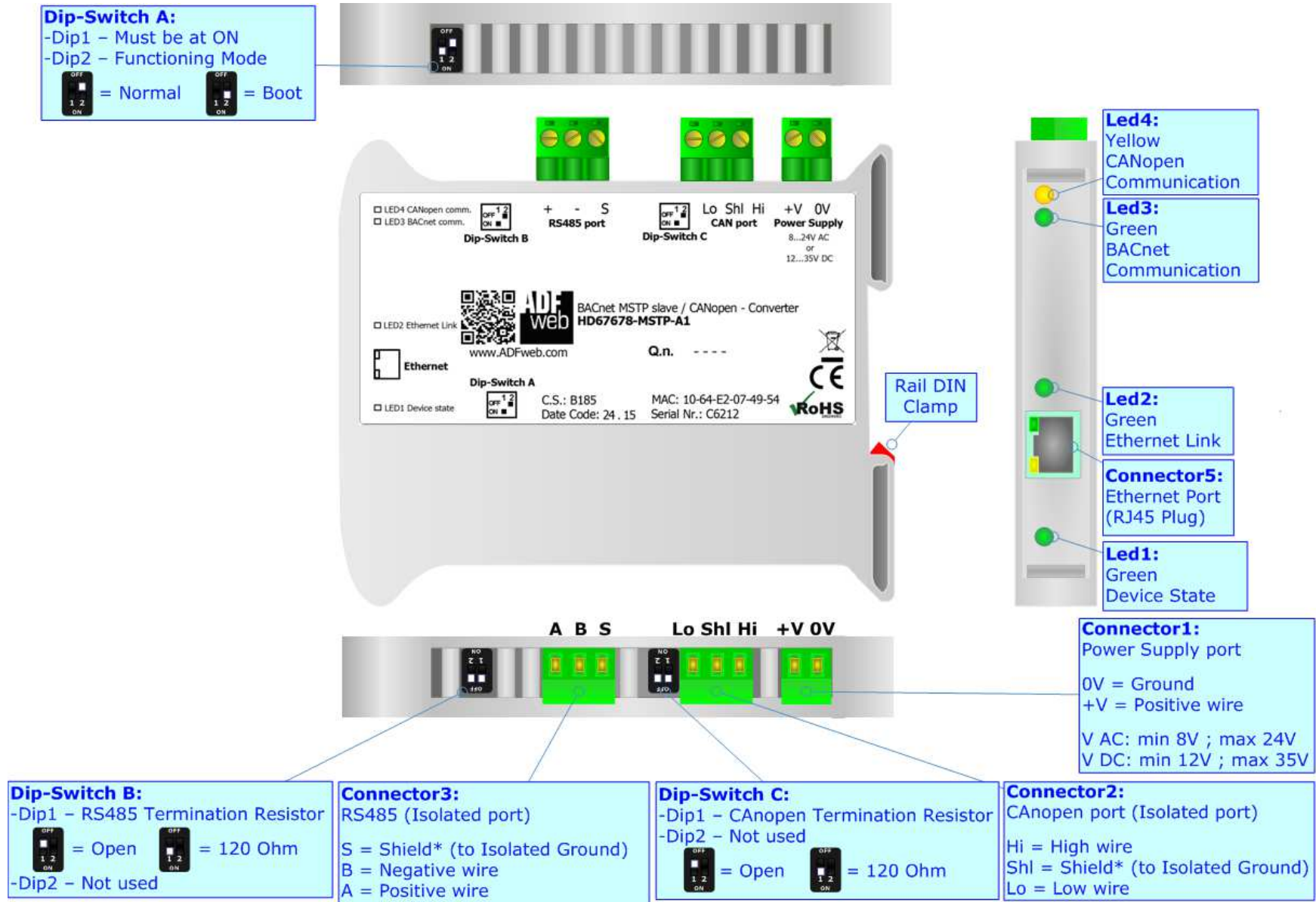

Figure 1b: Connection scheme for HD67678-MSTP-A1



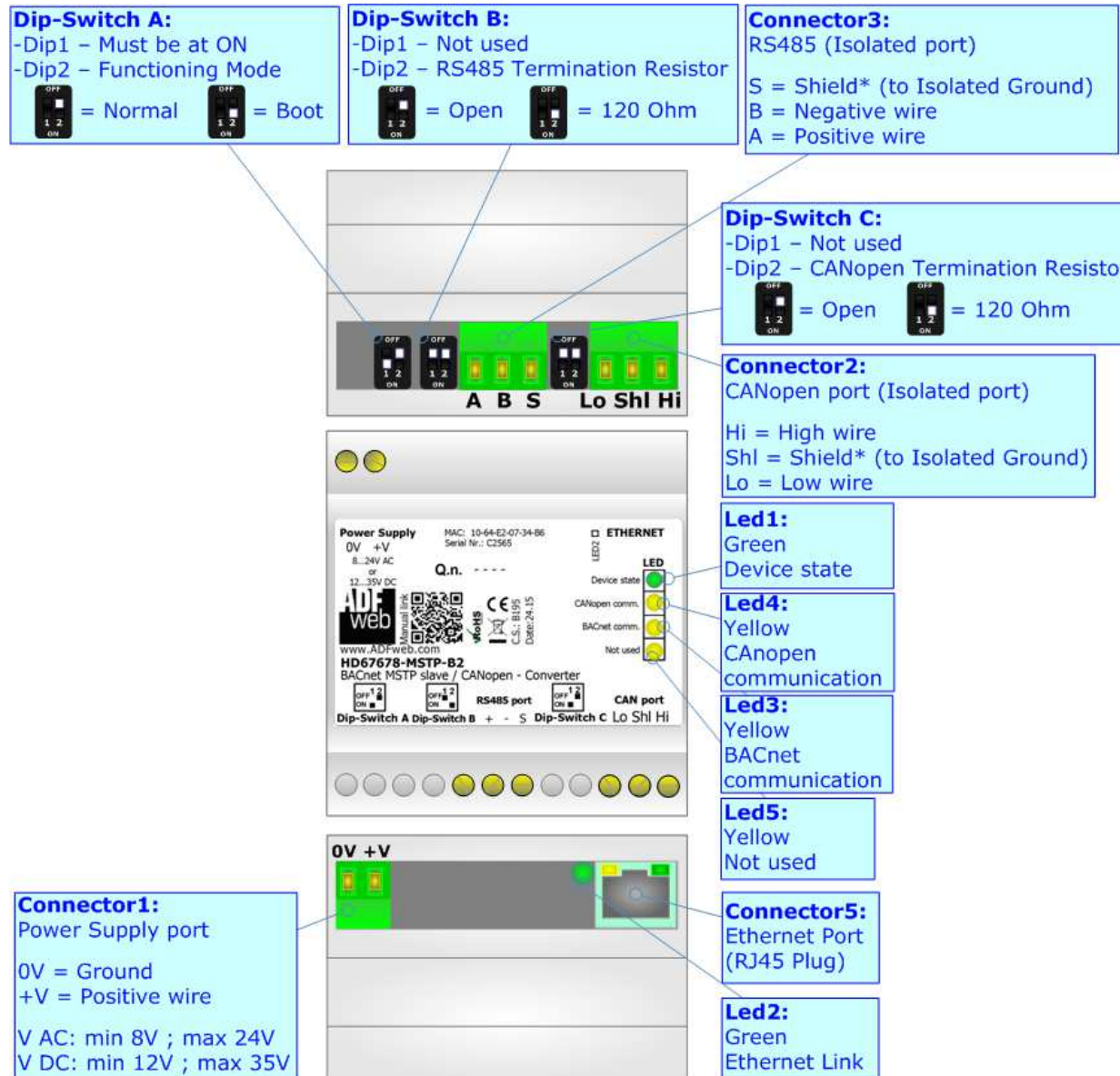
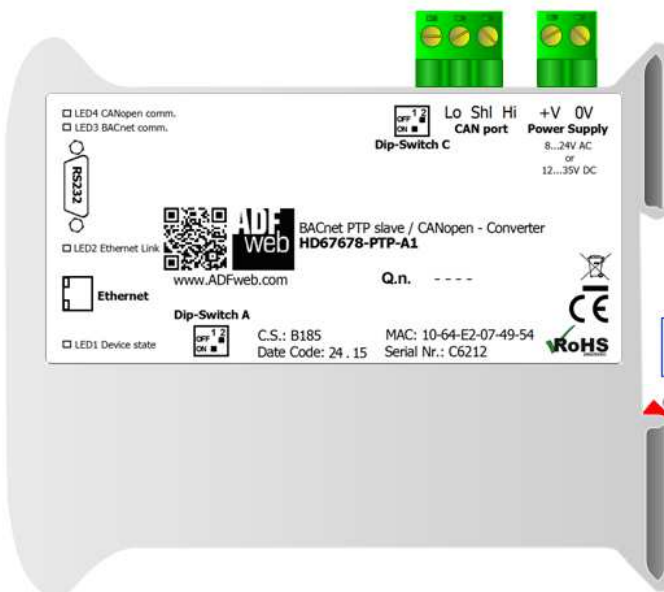
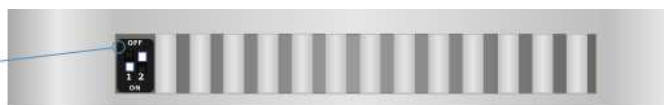

Figure 1c: Connection scheme for HD67678-MSTP-B2

**Dip-Switch A:**  
 -Dip1 – Must be at ON  
 -Dip2 – Functioning Mode

= Normal = Boot



Rail DIN Clamp



**Dip-Switch C:**  
 -Dip1 – CANopen Termination Resistor  
 -Dip2 – Not used

= Open = 120 Ohm

**Connector2:**  
 CANopen port (Isolated port)

Hi = High wire  
 Shl = Shield\* (to Isolated Ground)  
 Lo = Low wire

**Led4:**  
 Yellow  
 CANopen Communication

**Led3:**  
 Green  
 BACnet  
 Communication

**Led2:**  
 Green  
 Ethernet Link

**Connector5:**  
 Ethernet Port  
 (RJ45 Plug)

**Led1:**  
 Green  
 Device state

**Connector1:**  
 Power Supply port

0V = Ground  
 +V = Positive wire

V AC: min 8V ; max 24V  
 V DC: min 12V ; max 35V

**Connector 4:**  
 Port RS232 (D-SUB9-Male)  
 (Isolated Port)

PIN2 = RX  
 PIN3 = TX  
 PIN5 = GND\* (to Isolated Ground)

Used for:  
 - BACnet

To connect the device to the COM port of a PC in order to set it you have to use the programming cable AC34107 or a cable made as showed here:

**CABLE Side A FEM**      **CABLE Side B FEM**

Figure 1d: Connection scheme for HD67678-PTP-A1

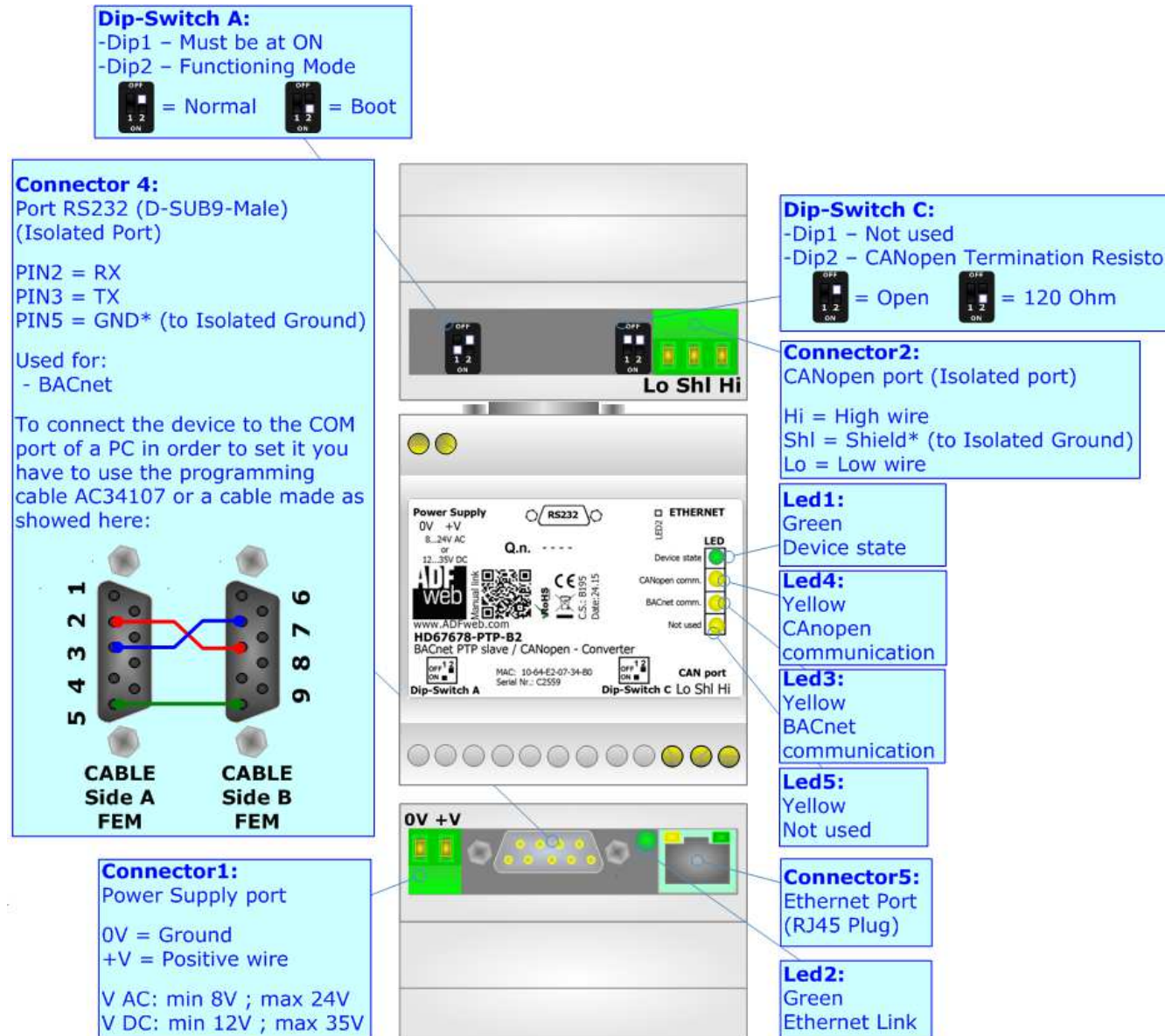

Figure 1e: Connection scheme for HD67678-PTP-B2

**CHARACTERISTICS:**

The HD67678-xxx-A1 and HD67678-xxx-B2 are BACnet slave / CANopen Converter.

It allows the following characteristics:

- Up to 2048 BACnet objects (Read+Write);
- Triple isolation between BACnet - Power Supply, BACnet - CANopen, Power Supply - CANopen.
- Two-directional information between BACnet bus and CANopen bus;
- Mountable on 35mm Rail DIN;
- Wide power supply input range: 8...24V AC or 12...35V DC;
- Wide temperature range: -40°C / 85°C [-40°F / +185°F].

**CONFIGURATION:**

You need Compositor SW67678 software on your PC in order to perform the following:

- Define the parameter of BACnet line;
- Define the parameter of CANopen line;
- Define which CANopen SDO contains BACnet information;
- Define which BACnet data saved/sent by CANopen SDO;
- Define which CANopen Receive PDO contains BACnet information;
- Define which BACnet data sent by CANopen Transmit PDO;
- Update the device.

**POWER SUPPLY:**

The devices can be powered at 8...24V AC and 12...35V DC. For more details see the two tables below.

VAC		VDC	
Vmin	Vmax	Vmin	Vmax
8V	24V	12V	35V

Consumption at 24V DC:

Device	Consumption [W/VA]
HD67678-IP-A1	3.5
HD67678-MSTP-A1/B2	3.5
HD67678-PTP-A1/B2	3.5

**Connector1:**  
Power Supply port  
0V = Ground  
+V = Positive wire  
V AC: min 8V ; max 24V  
V DC: min 12V ; max 35V

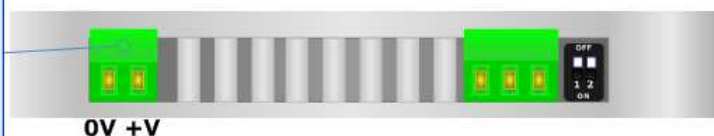

**Connector1:**  
Power Supply port  
0V = Ground  
+V = Positive wire  
V AC: min 8V ; max 24V  
V DC: min 12V ; max 35V

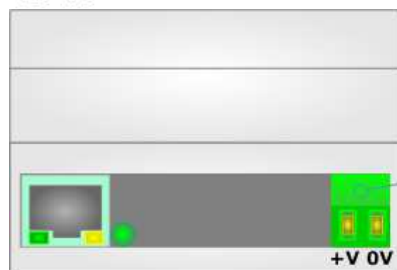

**Connector1:**  
Power Supply port  
0V = Ground  
+V = Positive wire  
V AC: min 8V ; max 24V  
V DC: min 12V ; max 35V

**Caution: Not reverse the polarity power**

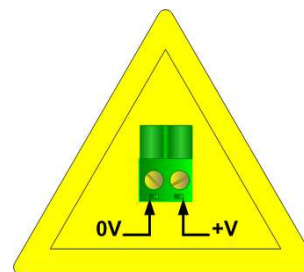

HD67725-IP-A1  
HD67725-MSTP-A1  
HD67725-PTP-A1

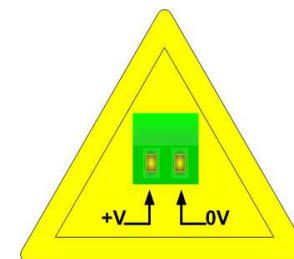

HD67725-MSTP-B2  
HD67725-PTP-B2



**FUNCTION MODES:**

The device has got two function modes depending on the position of the 'Dip2 of Dip-Switch A':

- The first, with 'Dip2 of Dip-Switch A' at "OFF" position, is used for the normal working of the device.
- The second, with 'Dip2 of Dip-Switch A' at "ON" position, is used for uploading the Project and/or Firmware.

For the operations to follow for the updating, see 'UPDATE DEVICE' section.

According to the functioning mode, the LEDs will have specific functions, see 'LEDS' section.

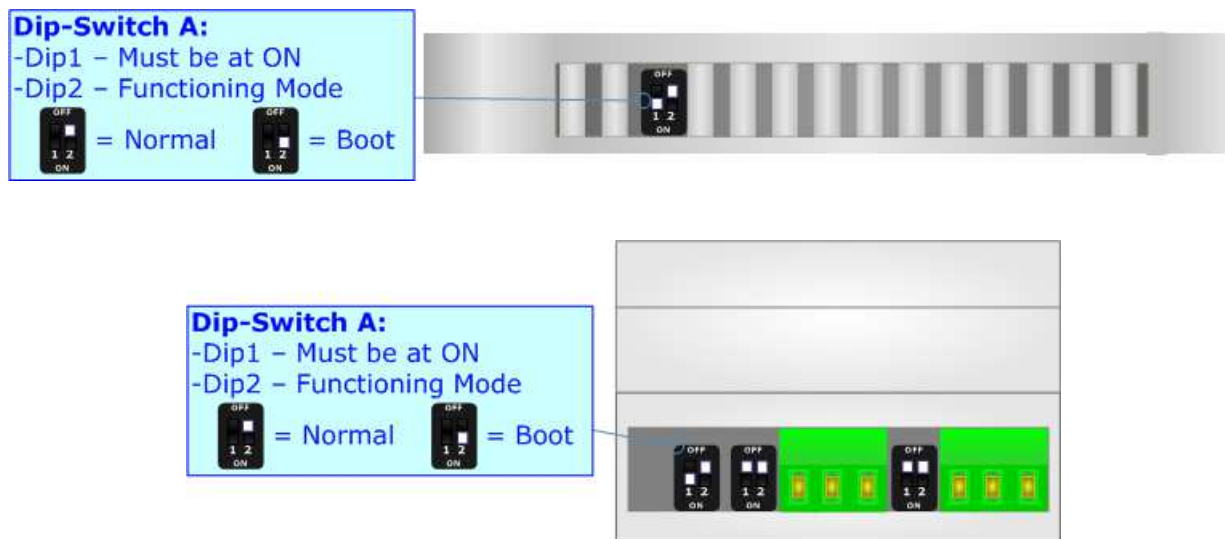

**Warning:**  
Dip1 of 'Dip-Switch A' must be at ON position for working even if the Ethernet cable isn't inserted.



**LEDS (for HD67678-IP-A1):**

The device has got six LEDs that are used to give information about the functioning status. The various meanings of the LEDs are described in the table below.

LED	Normal Mode	Boot Mode
1: ON [supply voltage ] (green)	<b>ON:</b> Device powered <b>OFF:</b> Device not powered	<b>ON:</b> Device powered <b>OFF:</b> Device not powered
2: CANopen comm. (green)	Blinks quickly when receives CANopen frames	<b>Blinks quickly:</b> Boot state <b>Blinks very slowly (~0.5Hz):</b> update in progress
3: Device state (green)	Blinks slowly (~1Hz)	<b>Blinks quickly:</b> Boot state <b>Blinks very slowly (~0.5Hz):</b> update in progress
4: BACnet comm. (green)	Blinks quickly when receive BACnet requests	<b>Blinks quickly:</b> Boot state <b>Blinks very slowly (~0.5Hz):</b> update in progress
5: Not used (green)	/	<b>Blinks quickly:</b> Boot state <b>Blinks very slowly (~0.5Hz):</b> update in progress
6: Not used (green)	/	<b>Blinks quickly:</b> Boot state <b>Blinks very slowly (~0.5Hz):</b> update in progress

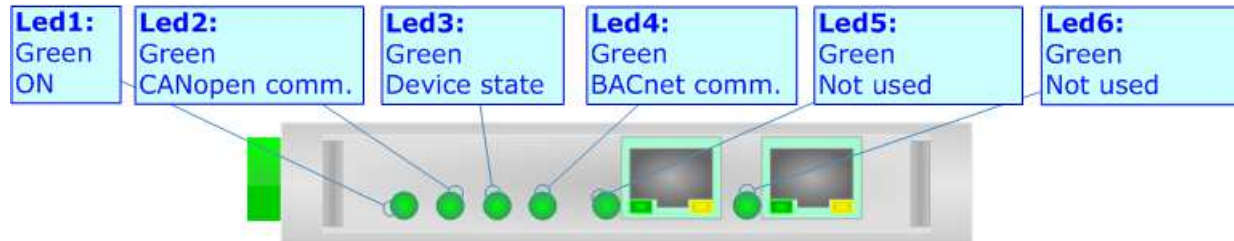

**LEDS (for HD67678-MSTP-A1/B2 and HD67678-PTP-A1/B2):**

The device has got four LEDs (five the -B2 version) that are used to give information about the functioning status. The various meanings of the LEDs are described in the table below.

LED	Normal Mode	Boot Mode
1: Device State (green)	Blinks slowly (~1Hz)	<b>ON:</b> Device powered <b>OFF:</b> Device not powered
2: Ethernet Link (green)	<b>ON:</b> Ethernet cable connected <b>OFF:</b> Ethernet cable disconnected	<b>Blinks quickly:</b> Boot state <b>Blinks very slowly (~0.5Hz):</b> update in progress
3: BACnet comm. (green)	Blinks quickly when receive BACnet requests	<b>Blinks quickly:</b> Boot state <b>Blinks very slowly (~0.5Hz):</b> update in progress
4: CANopen comm. (green)	Blinks quickly when receives CANopen frames	<b>Blinks quickly:</b> Boot state <b>Blinks very slowly (~0.5Hz):</b> update in progress
5: Not Used	OFF	<b>Blinks quickly:</b> Boot state <b>Blinks very slowly (~0.5Hz):</b> update in progress

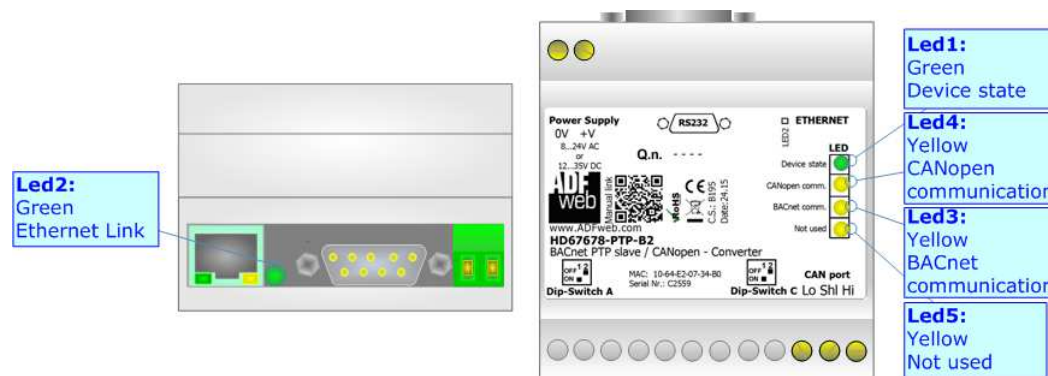
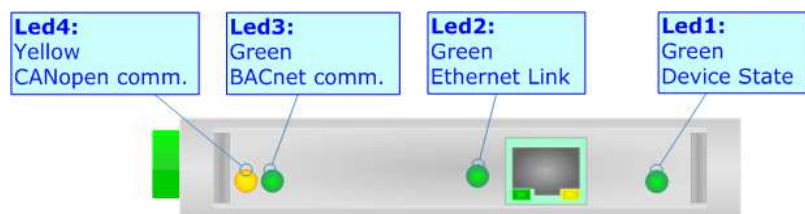

**RS485 (HD67678-MSTP-A1/B2):**

To terminate the RS485 line with a 120Ω resistor it is necessary to put ON dip 1, like in figure.

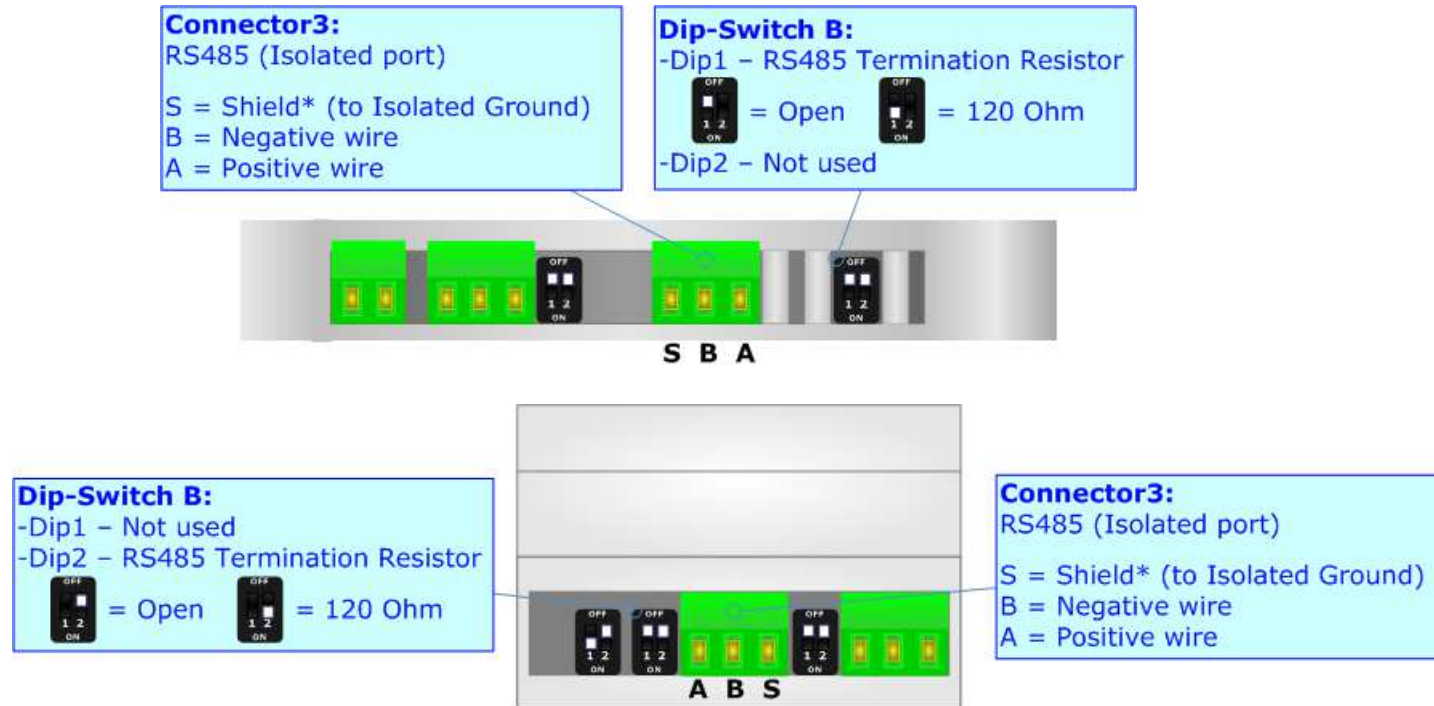

The maximum length of the cable should be 1200m (4000 feet).

Here some codes of cables:

- Belden: p/n 8132 - 2x 28AWG stranded twisted pairs conductor + foil shield + braid shield;
- Belden p/n 82842 - 2x 24AWG stranded twisted pairs conductor + foil shield + braid shield;
- Tasker: p/n C521 - 1x 24AWG twisted pair conductor + foil shield + braid shield;
- Tasker: p/n C522 - 2x 24AWG twisted pairs conductor + foil shield + braid shield.

**RS232 (HD67678-PTP-A1/B2):**

The connection from RS232 socket to a serial port (example one from a personal computer) must be made with a NULL MODEM cable (a serial cable where the pins 2 and 3 are crossed).  
It is recommended that the RS232 cable not exceed 15 meters.

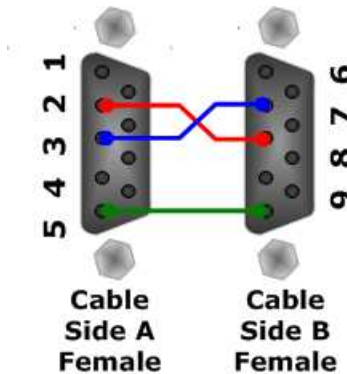

**ETHERNET:**

The BACnet/IP connection and the updating of the converters must be made using Connector3 and/or Connector4 and/or Connector5 of HD67678-xxx-A1/B2 with at least a Category 5E cable. The maximum length of the cable should not exceed 100m. The cable has to conform to the T568 norms relative to connections in cat.5 up to 100 Mbps. To connect the device to an Hub/Switch is recommended the use of a straight cable, to connect the device to a PC/PLC/other is recommended the use of a cross cable.



**CANOPEN:**

To terminate the CANopen line with a 120Ω resistor it is necessary to put ON dip 1, like in figure.

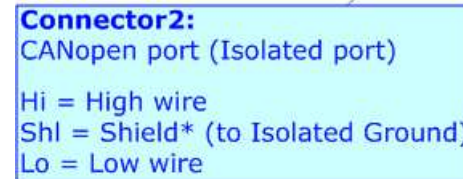
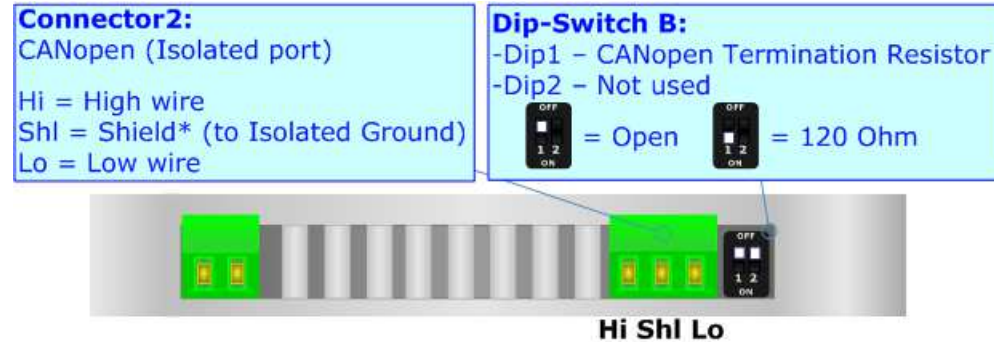

Cable characteristics:

<b>DC parameter:</b>	Impedance	70 Ohm/m
<b>AC parameters:</b>	Impedance	120 Ohm/m
	Delay	5 ns/m
<b>Length</b>	<b>Baud Rate [bps]</b>	<b>Length MAX [m]</b>
	10 K	5000
	20 K	2500
	50 K	1000
	100 K	650
	125 K	500
	250 K	250
	500 K	100
	800 K	50
	1000 K	25

**USE OF COMPOSITOR SW67678:**

To configure the Converter, use the available software that runs with Windows called SW67678. It is downloadable on the site [www.adfweb.com](http://www.adfweb.com) and its operation is described in this document. *(This manual is referenced to the last version of the software present on our web site).* The software works with MSWindows (XP, Vista, Seven, 8; 32/64bit).

When launching the SW67678, the window below appears (Fig. 2).

 **Note:**  
It is necessary to have installed .Net Framework 4.

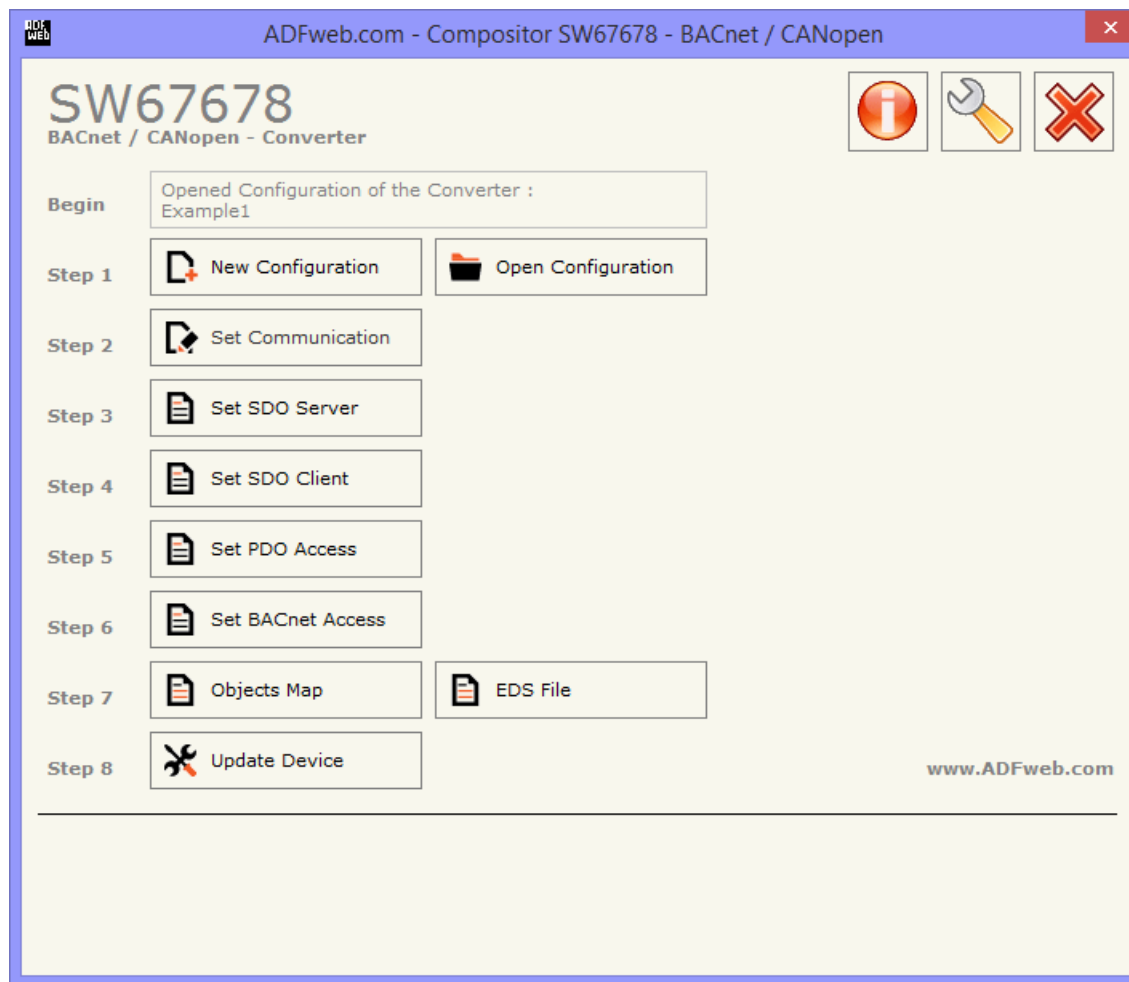
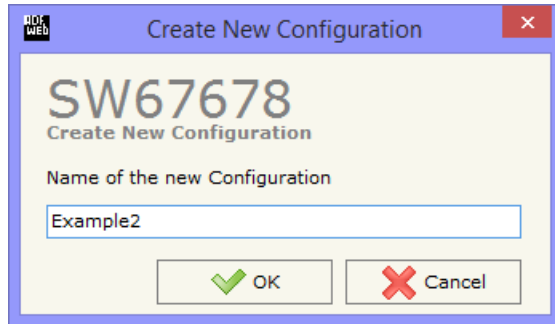

Figure 2: Main window for SW67678



**NEW CONFIGURATION / OPEN CONFIGURATION:**

The “**New Configuration**” button creates the folder which contains the entire device’s configuration.



A device’s configuration can also be imported or exported:

- To clone the configurations of a programmable “BACnet slave / CANopen - Converter” in order to configure another device in the same manner, it is necessary to maintain the folder and all its contents;
- To clone a project in order to obtain a different version of the project, it is sufficient to duplicate the project folder with another name and open the new folder with the button “**Open Configuration**”.

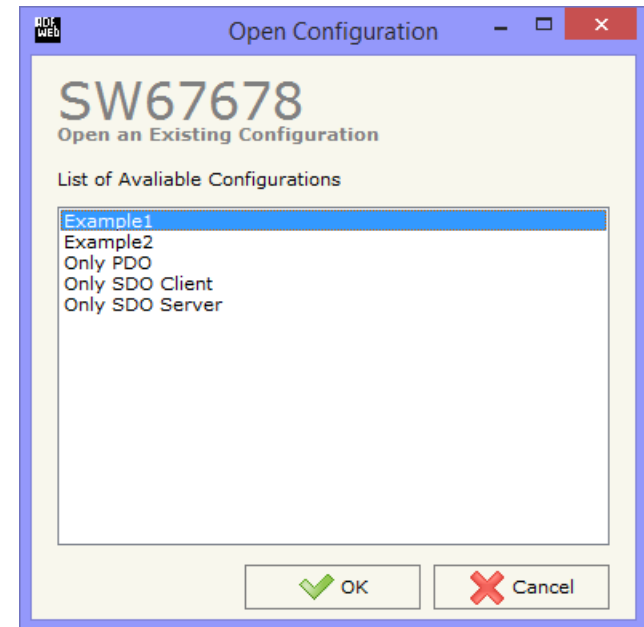

**SOFTWARE OPTIONS:**

By pressing the “**Settings**” () button there is the possibility to change the language of the software and check the updatings for the compositor.

In the section “Language” it is possible to change the language of the software.

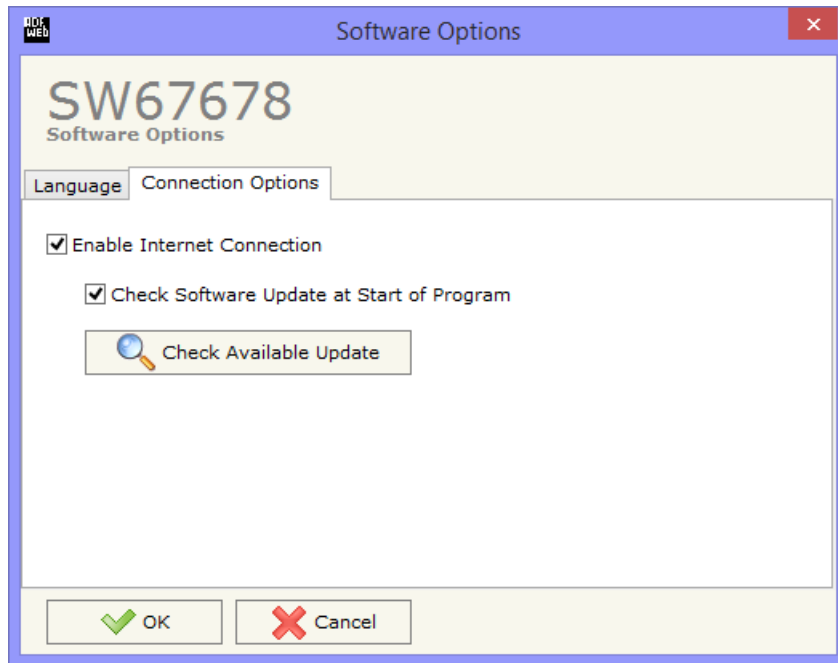

In the section “Connection Options”, it is possible to check if there are some updatings of the software compositor in ADFweb.com website. Checking the option “**Check Software Update at Start of Program**”, the SW67678 check automatically if there are updatings when it is launched.

## SET COMMUNICATION:

This section define the fundamental communication parameters of two buses, BACnet and CANopen.

By Pressing the **"Set Communication"** button from the main window for SW67678 (Fig. 2) the window "Set Communication" appears (Fig. 3).

In the section "BACnet Type" is possible to select the type of BACnet to use from:

- BACnet/IP (use ethernet);
- BACnet MS/TP (use RS485);
- BACnet PTP (use RS232).

If selected "BACnet/IP" the means of the fields for "BACnet" are:

- In the fields **"IP ADDRESS"** insert the IP address that you want to give to the Converter;
- In the fields **"SUBNET Mask"** insert the SubNet Mask;
- In the fields **"GATEWAY"** insert the default gateway that you want to use. This feature can be enabled or disabled pressing the Check Box field. This feature is used for going out of the net;
- In the field **"Port"** the port number used for BACnet communication is defined. The default port used for BACnet communication is 47808, but is possible to insert any value (except 10000 and 10001);
- In the field **"BACnet Device Name"** is possible to assign a name to the BACnet node;
- In the field **"Device Identifier"** is possible to assign a number to the BACnet node (Used for the Device Identifier).

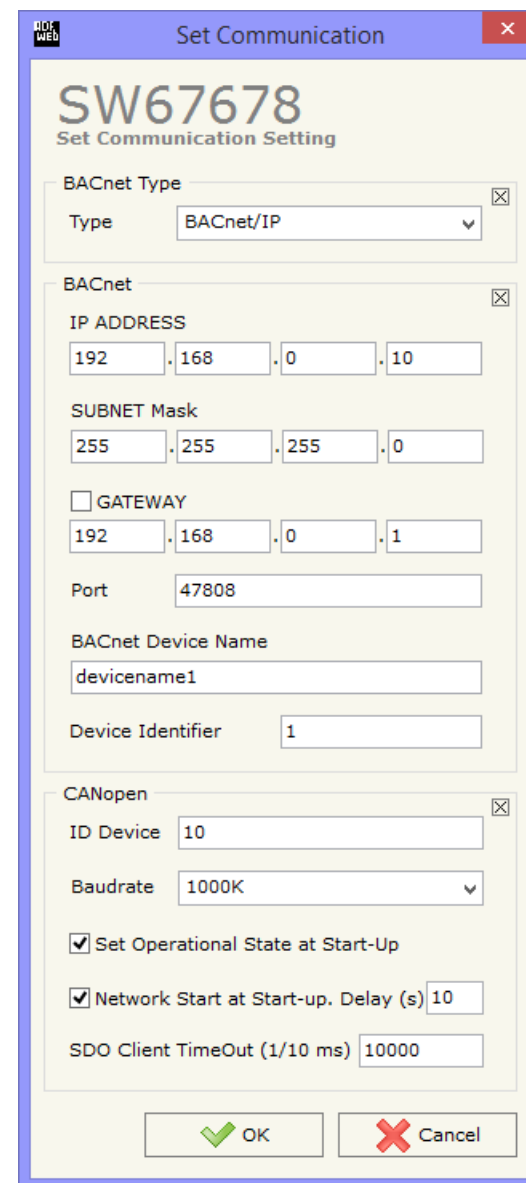

Figure 3: "Set Communication" window

The means of the fields for the "CANopen" section are the same for all types of BACnet:

- In the field "**Device ID**" the address for the CANopen side is defined;
- In the field "**Baudrate**" the baudrate of the CANopen line is defined;
- In the field "**Set Operational State at Start-up**" the state of the CANopen is defined. I.e. if it is checked, the board starts in operational State, else it starts in Preoperational;
- In the field "**Network Start at Start-up**" the state of the network CANopen is defined. I.e. if it is checked, the board sends a command to set the Operational State of all the devices present in the network;
- In the field "**Delay**" the delay before sending the network command for the CANopen is defined;
- In the field "**SDO Client TimeOut (1/10 ms)**" insert a time. It is the maximum time that the device attends for the answer from the Slave interrogated.

If selected "BACnet MS/TP" or "BACnet PTP" the means of the fields for "BACnet" are:

- ➔ In the field "**Baudrate**" it is possible to select the baudrate of the BACnet line (1200, 2400, 4800, 9600, 19200, 38400, 57600, 115200);
- ➔ In the field "**Parity**" it is possible to select the parity of the line (None, Odd, Even);
- ➔ In the field "**BACnet Device Name**" is possible to insert the name to give to the BACnet node (maximum 17 characters);
- ➔ In the field "**MAC Address**" is possible to define the MAC of BACnet node (from 0 to 254);

The means of the fields for the "Ethernet Update" section are:

- ➔ In the fields "**IP ADDRESS**" insert the IP address that you want to give to the Converter;
- ➔ In the fields "**SUBNET Mask**" insert the SubNet Mask;
- ➔ In the fields "**GATEWAY**" insert the default gateway that you want to use. This feature can be enabled or disabled pressing the Check Box field. This feature is used for going out of the net.

These information are used for programming the Converter.

The image displays two side-by-side screenshots of the "Set Communication" configuration window for device SW67678. Both windows show the same configuration options, but with different BACnet Type selections.

**Left Screenshot (BACnet PTP):**

- BACnet Type:** Type: BACnet PTP
- BACnet:** Baudrate: 57600, Parity: NONE, MAC Address: 0, BACnet Device Name: devicename1
- Ethernet Update:** IP ADDRESS: 192.168.0.10, SUBNET Mask: 255.255.255.0, GATEWAY: 192.168.0.1
- CANopen:** ID Device: 10, Baudrate: 1000K,  Set Operational State at Start-Up,  Network Start at Start-up. Delay (s): 10, SDO Client TimeOut (1/10 ms): 10000

**Right Screenshot (BACnet MS/TP):**

- BACnet Type:** Type: BACnet MS/TP
- BACnet:** Baudrate: 57600, Parity: NONE, MAC Address: 0, BACnet Device Name: devicename1
- Ethernet Update:** IP ADDRESS: 192.168.0.10, SUBNET Mask: 255.255.255.0, GATEWAY: 192.168.0.1
- CANopen:** ID Device: 10, Baudrate: 1000K,  Set Operational State at Start-Up,  Network Start at Start-up. Delay (s): 10, SDO Client TimeOut (1/10 ms): 10000

### SET SDO SERVER:

By pressing the “**Set SDO Server**” button from the main window for SW67678 (Fig. 2) the window “Set SDO Server Access” appears (Fig. 4).

This window is made to create the SDO in read or write in the CANopen side, and to indicate which byte are associated to these SDOs.

It is divided in two parts, the “SDO in read” and the “SDO in Write”.

The first part is used to read, using the SDO, the data arrived from the BACnet.

The second is used to write, using SDO, the data that will be sent to the BACnet.

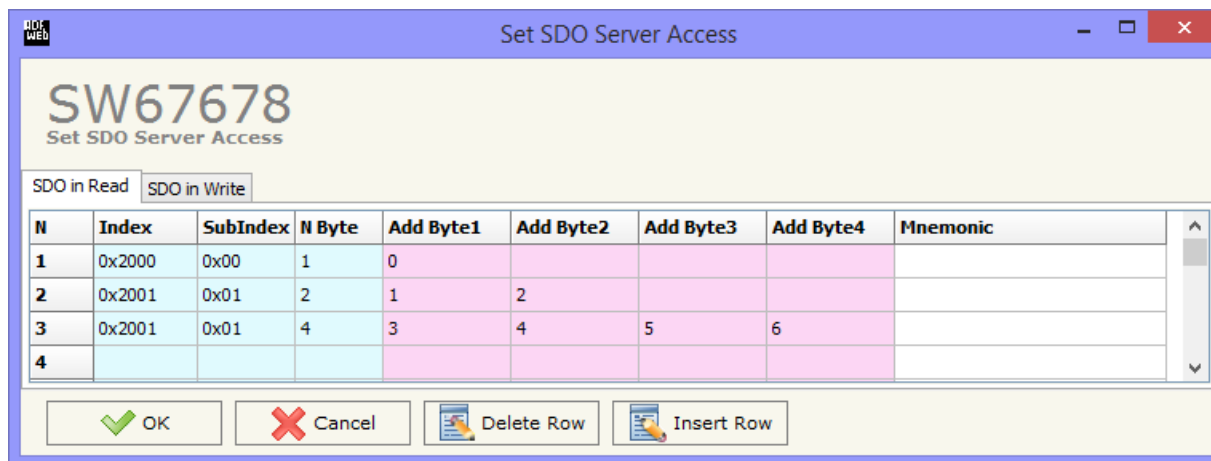

Figure 4: “Set SDO Server Access” windows

The data of the columns have the following meanings:

- In the field “**Index**” the address of the SDO is defined;
- In the field “**SubIndex**” the second address of the SDO is defined;
- In the field “**N Byte**” the dimension of the SDO is defined (it can be 1, 2 or 4);
- In the field “**Address Byte1**” insert the address of the BACnet arrays where read/write first byte of the SDO;
- In the field “**Address Byte2**” insert the address of the BACnet arrays where read/write second byte of the SDO (only if N Byte is 2 or 4);
- In the field “**Address Byte3**” insert the address of the BACnet arrays where read/write third byte of the SDO (only if N Byte is 4);
- In the field “**Address Byte4**” insert the address of the BACnet arrays where read/write fourth byte of the SDO (only if N Byte is 4);
- In the field “**Mnemonic**” the description for the SDO is defined.



**Note:**

It is possible to configure a maximum of 1000 SDOs (500 in read and 500 in write) in the “Set SDO Server Access” section.



**SET SDO CLIENT:**

By pressing the "Set SDO Client" button from the main window for SW67678 (Fig. 2) the window "Set SDO Client Access" appears (Fig. 5a and 5b).

With the SDO Client the HD67678-A1 converter can read and/or write the data from other devices connected in the network CANopen.

It is divided in two parts, the "SDO Read" and the "SDO Write". The first part is used to read, using the SDOs, the data in another device and then put this data in the BACnet side. The second part is used to write, using the SDO, the data present in the BACnet side to other CANopen devices.

The data of the columns in the "SDO Read" have the following meanings:

- In the field "ID Device" insert the ID of the device used to read the data;
- In the field "Index" the address for the SDO is defined;
- In the field "SubIndex" the second address for the SDO is defined;
- In the field "N Byte" the dimension of the SDO is defined (it can be 1, 2, or 4);
- In the field "Poll Time" insert the time to make this request;
- In the field "Address Byte1" the address of the BACnet array where copying the first byte of the SDO read is defined;
- In the field "Address Byte2" the address of the BACnet array where copying the second byte of the SDO read is defined (only if N Byte is 2 or 4);
- In the field "Address Byte3" the address of the BACnet array where copying the third byte of the SDO read is defined (only if N Byte is 4);
- In the field "Address Byte4" the address of the BACnet array where copying the fourth byte of the SDO read is defined (only if N Byte is 4);
- In the field "Mnemonic" the description for the SDO is defined.

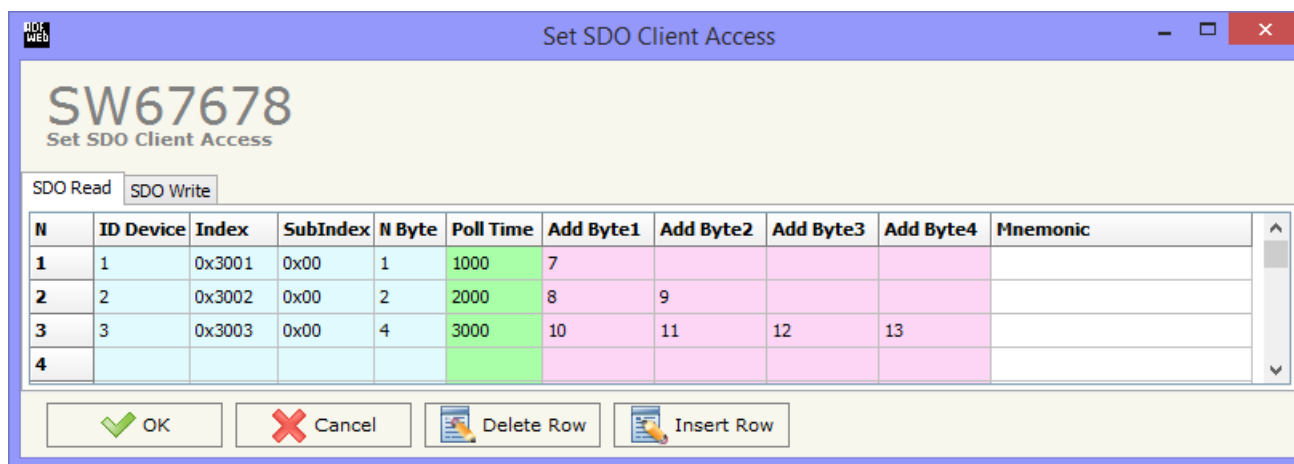

Figure 5a: "Set SDO Client Access – SDO Read" window

It is possible to configure a maximum of 256 read SDOs in the "Set SDO Client Access – SDO Read" section.

The data of the columns in the "SDO Write" have the following meanings:

- In the field "ID Device" insert the ID of the device used to write the data;
- In the field "Index" the address for the SDO is defined;
- In the field "SubIndex" the second address for the SDO is defined;
- In the field "N Byte" the dimension of the SDO is defined (it can be 1, 2, or 4);
- In the field "Poll Time" insert the time to make this request;
- If the field "On Change" is checked, the gateway send the Write SDO request when the data change the value;
- In the field "Address Byte1" the address of the BACnet array where reading the first byte of the SDO write is defined;
- In the field "Address Byte2" the address of the BACnet array where reading the second byte of the SDO write is defined (only if N Byte is 2 or 4);
- In the field "Address Byte3" the address of the BACnet array where reading the third byte of the SDO write is defined (only if N Byte is 4);
- In the field "Address Byte4" the address of the BACnet array where reading the fourth byte of the SDO write is defined (only if N Byte is 4);
- In the field "Mnemonic" the description for the SDO is defined.

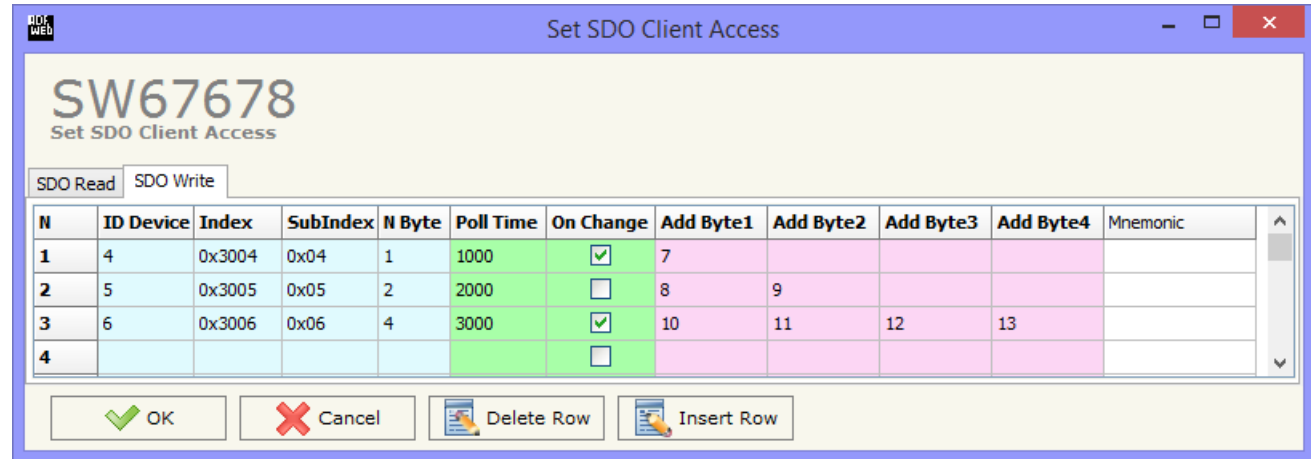

Figure 5b: "Set SDO Client Access – SDO Write" window



**Note:**

It is possible to configure a maximum of 256 write SDOs in the "Set SDO Client Access – SDO Write" section.

**SET PDO ACCESS:**

By pressing the "Set PDO Access" button from the main window for SW67678 (Fig. 2) the window "Set PDO Access" appears (Fig. 6a and 6b).

This window is made to create the Receive and Transmit PDOs in CANopen side, and to indicate which bytes are associated to these PDOs.

It is divided in two parts, the "Receive PDO" and the "Transmit PDO". The first part is used to Receive PDO in the CANopen network and copy the data in the BACnet side. The second part is used to Transmit PDO in the CANopen network with the data of BACnet side.

The data of the columns in the "Receive PDO" have the following meanings:

- In the Field "Cob-ID" the address for the PDO is defined;
- In the Field "Dimension" the dimension of the PDO is defined (it can be between 1 and 8);
- In the Field "Add B1" the address of the BACnet array where saving the first byte of the PDO is defined;
- In the Field "Add B2" the address of the BACnet array where saving the second byte of the PDO is defined (only if Dimension > 1);
- In the Field "Add B3" the address of the BACnet array where saving the third byte of the PDO is defined (only if Dimension > 2);
- In the Field "Add B4" the address of the BACnet array where saving the fourth byte of the PDO is defined (only if Dimension > 3);
- In the Field "Add B5" the address of the BACnet array where saving the fifth byte of the PDO is defined (only if Dimension > 4);
- In the Field "Add B6" the address of the BACnet array where saving the sixth byte of the PDO is defined (only if Dimension > 5);
- In the Field "Add B7" the address of the BACnet array where saving the seventh byte of the PDO is defined (only if Dimension > 6);
- In the Field "Add B8" the address of the BACnet array where saving the eighth byte of the PDO is defined (only if Dimension > 7);
- The field "TimeOut" is used for put at zero the data into BACnet if the PDO arrives with a frequency less than the time expressed in the field. If the value in the field is 0, means that you don't want to use this feature, and so the value is never deleted;

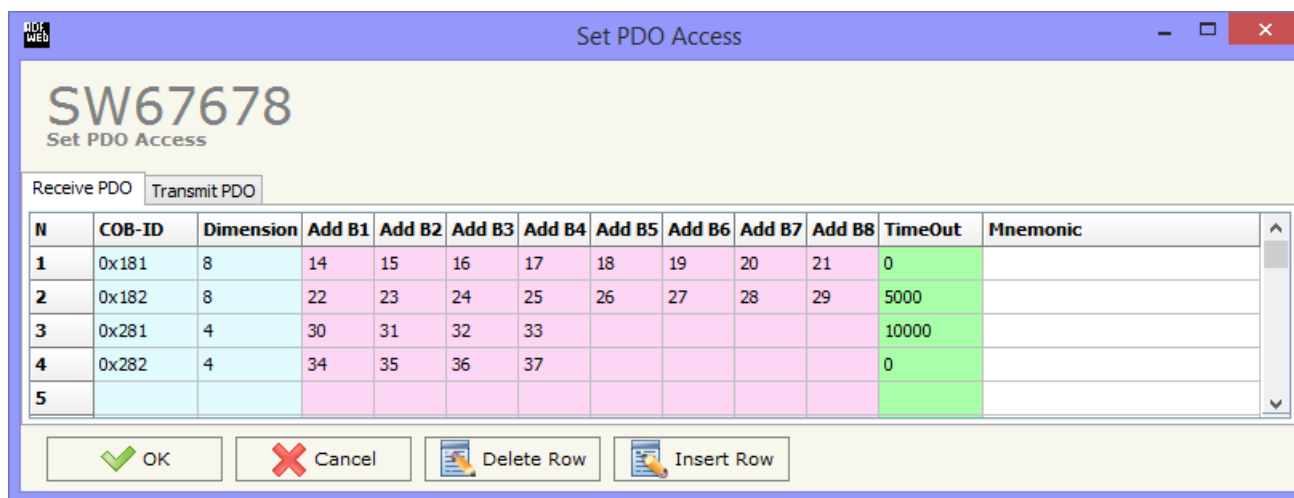

Figure 6a: "Set PDO Access – Receive PDO" window

- In the field "**Mnemonic**" the description for the PDO is defined.



**Note:**

It is possible to configure a maximum of 30 Receive PDO in the "Set PDO Access – Receive PDO".

The data of the columns in the "**Transmit PDO**" have the following meanings:

- In the Field "**Cob-ID**" the address for the PDO is defined;
- In the Field "**Dimension**" the dimension of the PDO is defined (it can be between 1 and 8);
- In the Field "**Add B1**" the address of the BACnet array that will be loaded in the first byte of the PDO is defined;
- In the Field "**Add B2**" the address of the BACnet array that will be loaded in the second byte of the PDO is defined (only if **Dimension** > 1);
- In the Field "**Add B3**" the address of the BACnet array that will be loaded in the third byte of the PDO is defined (only if **Dimension** > 2);
- In the Field "**Add B4**" the address of the BACnet array that will be loaded in the fourth byte of the PDO is defined (only if **Dimension** > 3);
- In the Field "**Add B5**" the address of the BACnet array that will be loaded in the fifth byte of the PDO is defined (only if **Dimension** > 4);
- In the Field "**Add B6**" the address of the BACnet array that will be loaded in the sixth byte of the PDO is defined (only if **Dimension** > 5);
- In the Field "**Add B7**" the address of the BACnet array that will be loaded in the seventh byte of the PDO is defined (only if **Dimension** > 6);
- In the Field "**Add B8**" the address of the BACnet array that will be loaded in the eighth byte of the PDO is defined (only if **Dimension** > 7);

N	COB-ID	Dimension	Add B1	Add B2	Add B3	Add B4	Add B5	Add B6	Add B7	Add B8	Send Time	On Change	Mnemonic
1	0x201	8	14	15	16	17	18	19	20	21	1000	<input type="checkbox"/>	
2	0x202	8	22	23	24	25	26	27	28	29	1000	<input type="checkbox"/>	
3	0x301	4	30	31	32	33					5000	<input checked="" type="checkbox"/>	
4	0x302	4	34	35	36	37					5000	<input checked="" type="checkbox"/>	
5												<input type="checkbox"/>	

Figure 6b: "Set PDO Access – Transmit PDO" window

- In the Field "**Send Time**" insert the interval used to send the PDO. The time is in milliseconds;
- If the field "**On Change**" is checked, the gateway send the Transmit PDO when the data change the value;
- In the field "**Mnemonic**" the description for the PDO is defined.

**Note:**

It is possible to configure a maximum of 30 Transmit PDO in the "Set PDO Access – Transmit PDO".

**SET BACNET ACCESS:**

By Pressing the "Set BACnet Access " button from the main window for SW67678 (Fig. 2) the window "BACnet Set Access" appears (Fig. 7).

The window is divided in two parts, the "BACnet in Read" that contains the BACnet objects readable by a BACnet master (the CANopen data associated to these objects arrives to the converter); and "BACnet in write" that contains the BACnet objects writeable by a BACnet master (the CANopen data associated to these objects are sent by the Converter).

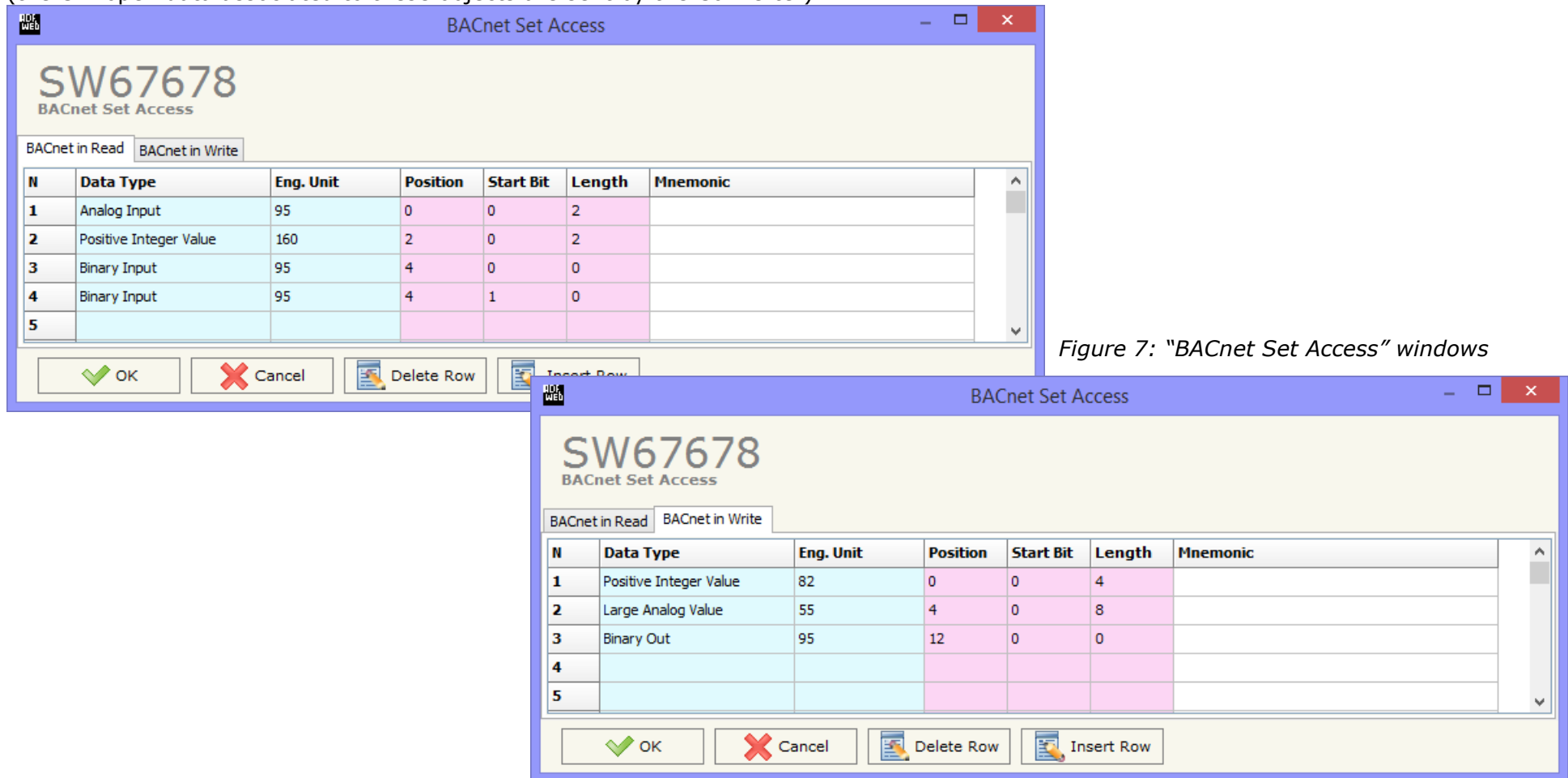



Figure 7: "BACnet Set Access" windows

The meaning of the fields in the window are the follows:

- In the field "**Data Type**" is possible to select the BACnet object data type;
- In the field "**Eng. Unit**", with double click the window "*Select the BACnet Engineering Unit*" appears (Fig. 9);
- In the field "**Position**" is possible to select the position where take/save the data from a 6000 bytes array;
- The field "**Start Bit**" is used for the "Binary In" and "Binary Out" BACnet objects;
- The field "**Length**" is used for all the others BACnet objects.

 **Notes:**

On "BACnet in Write" the dimensions (Length) of the variable is fixed. 'Analog Output' occupies 4 bytes, 'Positive Integer Value' occupies 4 bytes, 'Large Analog Value' occupies 8 bytes and 'Binary Out' occupies 1 byte.

The "BACnet in Write" object are also readable.

For writing the data, using 'Present\_Value' property, is necessary to use the Type 'Real' for the 'Analog Output', Type 'Double' for the 'Large Analog Value', Type 'Unsigned' for the 'Positive Integer Value' and Type 'Enumerated' for the 'Binary Output'.

The "Mnemonic" field is readable like 'Object\_Name' and 'Description' property of BACnet variable.

Is possible to insert directly the Unit (using its unique number) by compiling the "**Selected BACnet Engineering Unit**" field; or by selecting with the fields "**Select the Type**" and "**Select unit**" the Type/Unit desired. If the second way is used, is necessary to press the "**Select Engineering Unit**" button for confirm the choice.

**OBJECTS MAP:**

By Pressing the "**Objects Map**" button from the main window for SW67678 (Fig. 2) is possible to create a .csv document with the map of BACnet Objects.

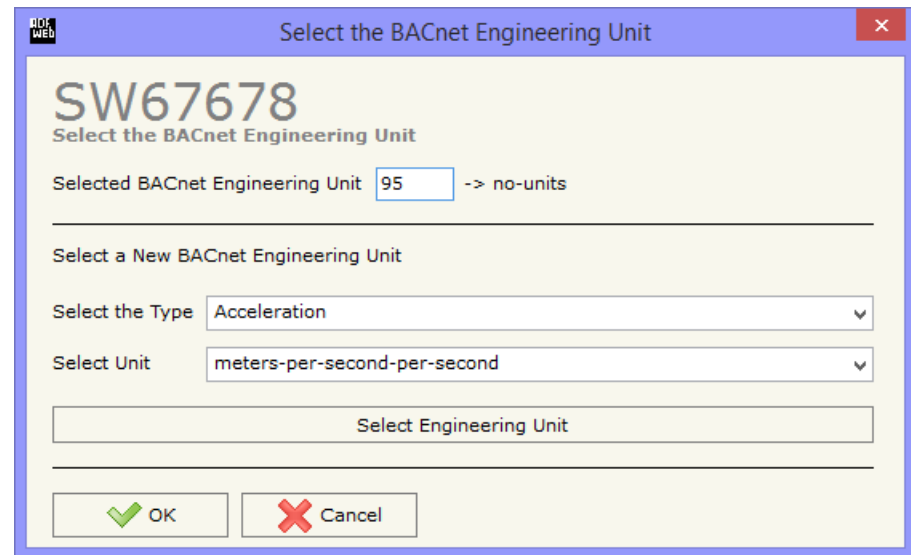

Figure 8: "Select the BACnet Engineering Unit" window



**UPDATE DEVICE:**

By pressing the **“Update Device”** button, it is possible to load the created Configuration into the device; and also the Firmware, if necessary.

If you don't know the actual IP address of the device you have to use this procedure:

- Turn off the Device;
- Put Dip2 of 'Dip-Switch A' in ON position;
- Turn on the device
- Connect the Ethernet cable;
- Insert the IP **“192.168.2.205”**;
- Press the **“Ping”** button, “Device Found! must appear”;
- Press the **“Next”** button;
- Select which operations you want to do;
- Press the **“Execute update firmware”** button to start the upload;
- When all the operations are “OK” turn off the Device;
- Put Dip2 of 'Dip-Switch A' in OFF position;
- Turn on the device.

At this point the configuration/firmware on the device is correctly updated.

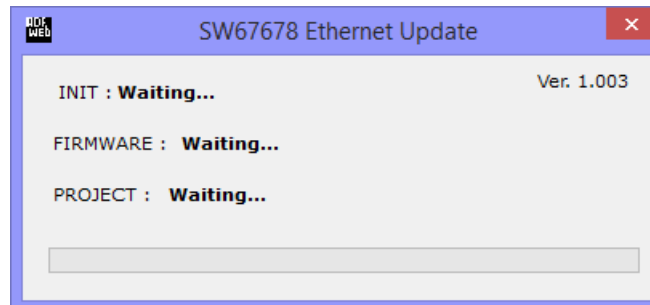
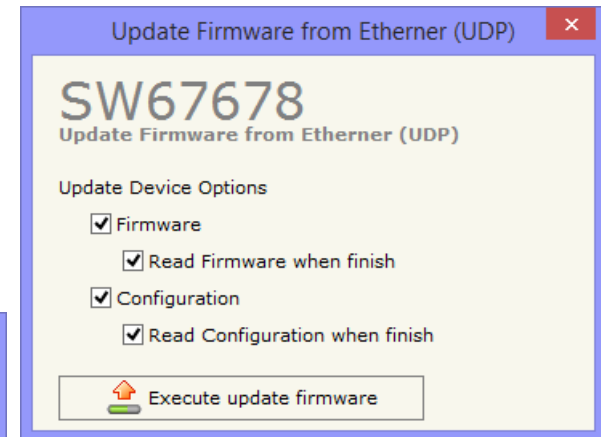
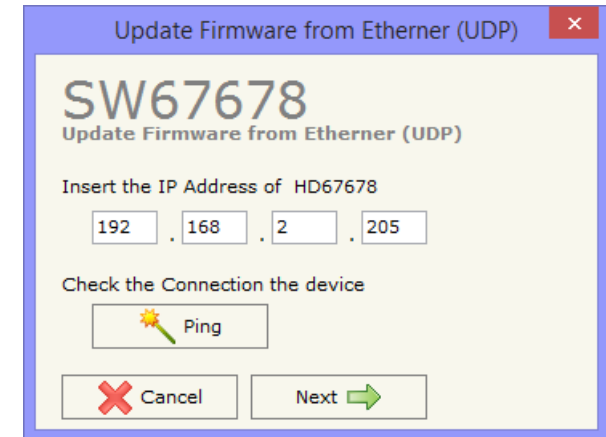

Figure 9: “Update device” windows

If you know the actual IP address of the device, you have to use this procedure:

- Turn on the Device with the Ethernet cable inserted;
- Insert the actual IP of the Converter;
- Press the "**Ping**" button, must appear "Device Found!";
- Press the "**Next**" button;
- Select which operations you want to do;
- Press the "**Execute update firmware**" button to start the upload;
- When all the operations are "OK" the device automatically goes at Normal Mode.

At this point the configuration/firmware on the device is correctly update.



Note:

When you install a new version of the software, if it is the first time it is better you do the update of the Firmware in the HD67678 device.



Note:

When you receive the device, for the first time, you also have to update the Firmware in the HD67678 device.



Warning:

If Fig. 10 appears when you try to do the Update try these points before seeking assistance:

- Try to repeat the operations for the update;
- Try with another PC;
- Try to restart the PC;
- If you are using the program inside a Virtual Machine, try to use it in the main Operating System;
- If you are using Windows Seven or Vista or 8, make sure that you have the administrator privileges;
- Pay attention to the Firewall lock;
- Check the LAN settings.

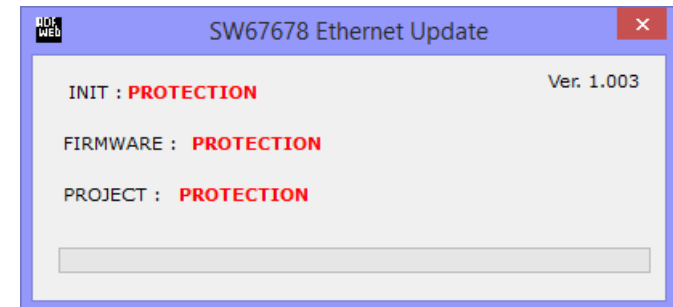
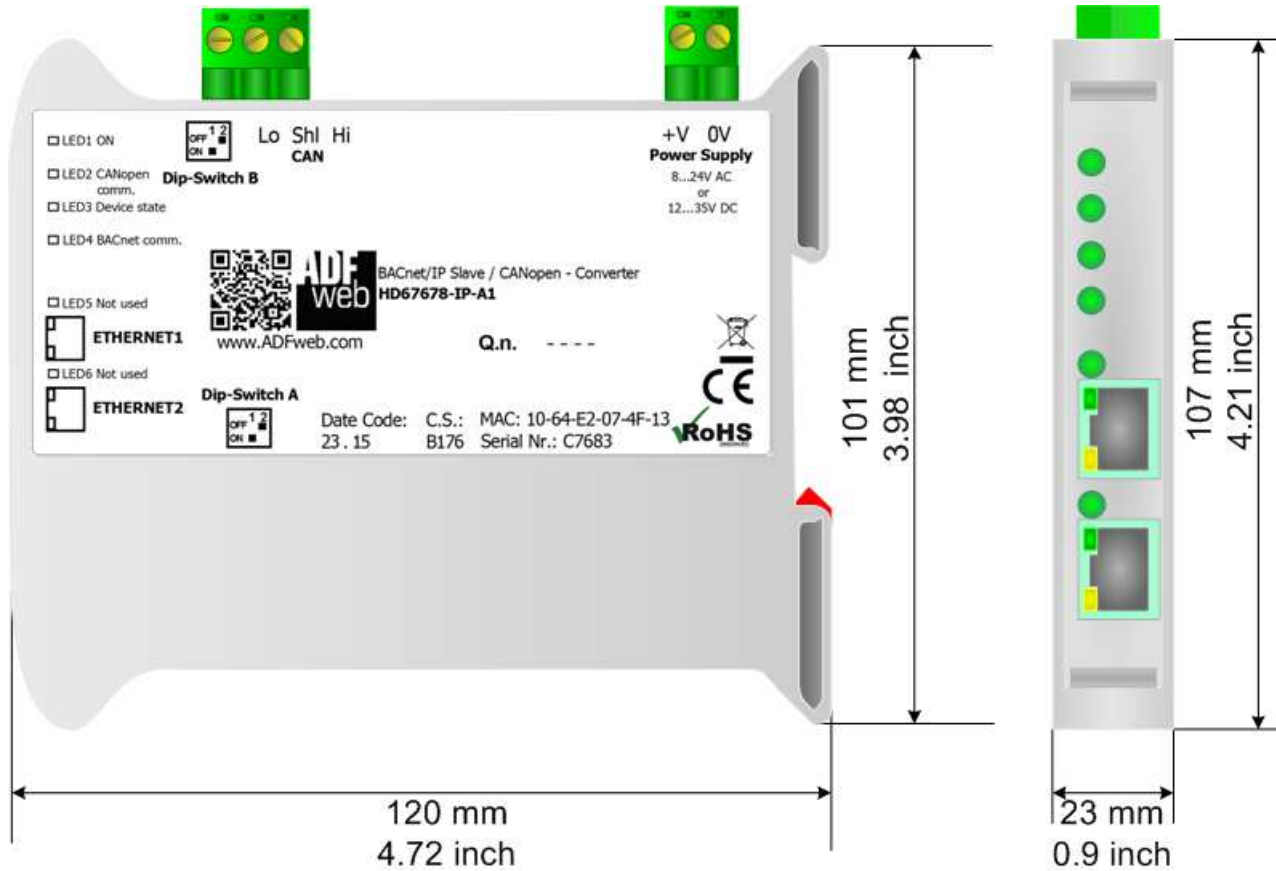

Figure 10: "Protection" window



In the case of HD67678 you have to use the software "SW67678": [www.adfweb.com/download/filefold/SW67678.zip](http://www.adfweb.com/download/filefold/SW67678.zip).

**MECHANICAL DIMENSIONS:**



Housing: PVC  
Weight: 200g (Approx)

Figure 11a: Mechanical dimensions scheme for HD67678-IP-A1

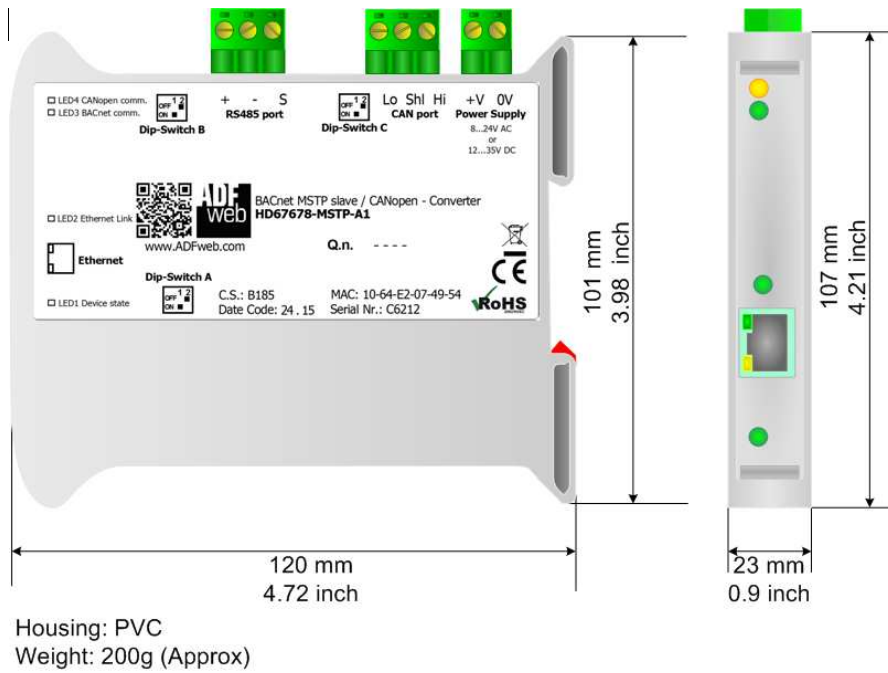

Figure 11b: Mechanical dimensions scheme for HD67678-MSTP-A1

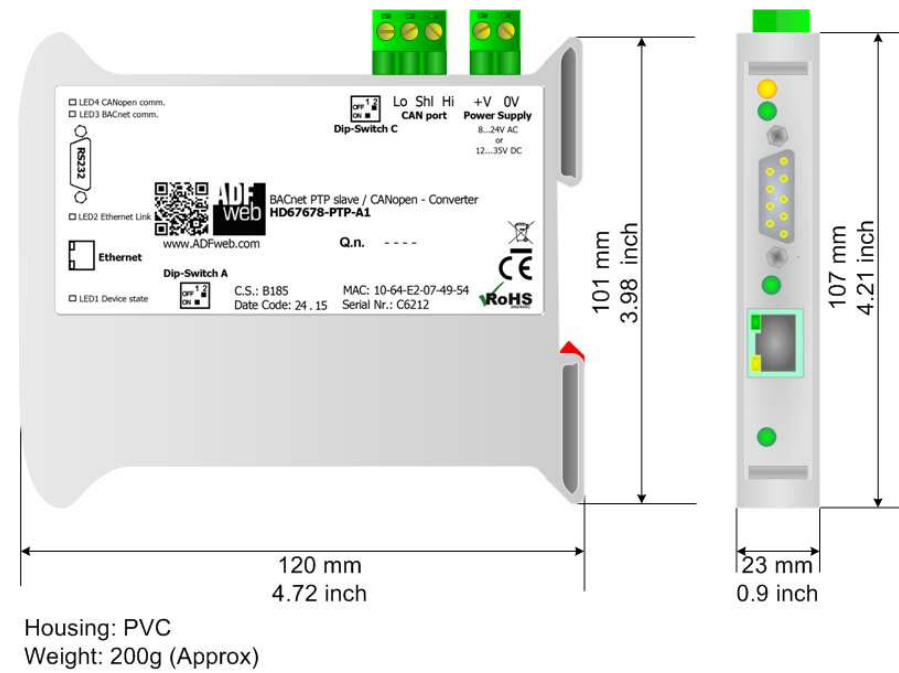
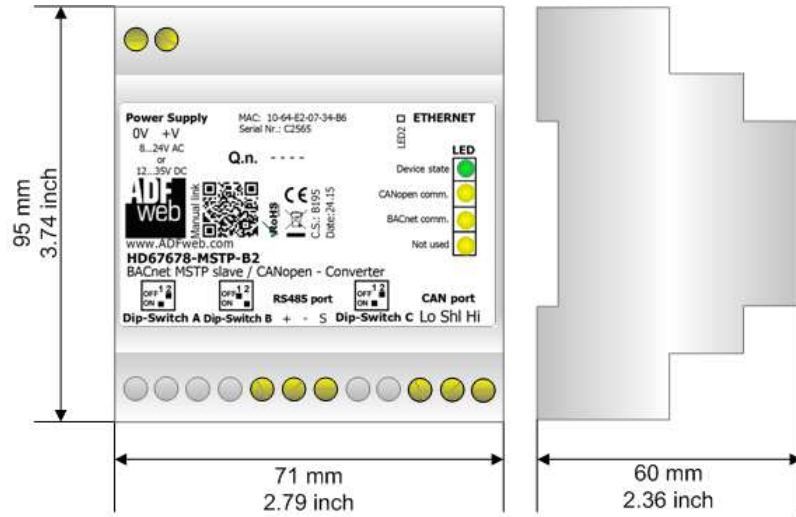
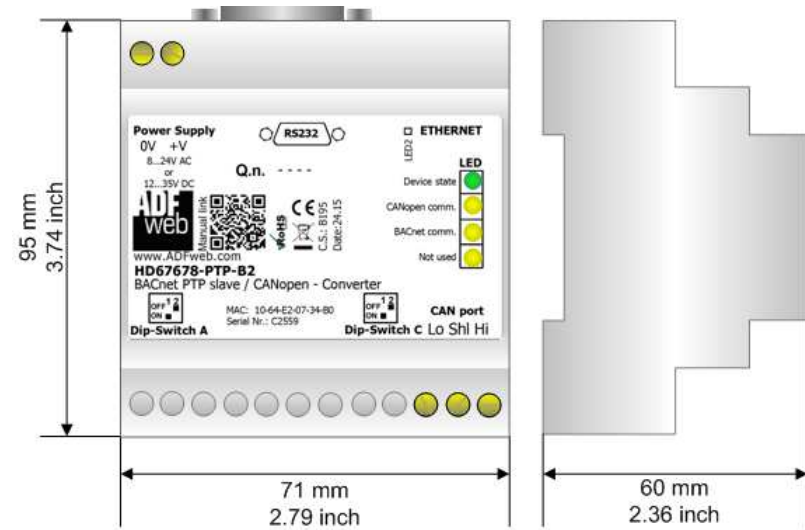

Figure 11c: Mechanical dimensions scheme for HD67678-PTP-A1



Housing: PVC  
Weight: 200g (Approx)

Figure 11d: Mechanical dimensions scheme for HD67678-MSTP-B2



Housing: PVC  
Weight: 200g (Approx)

Figure 11e: Mechanical dimensions scheme for HD67678-PTP-B2

## ORDERING INFORMATIONS:

The ordering part number is formed by a valid combination of the following:

**HD67678 - xxx - xx**

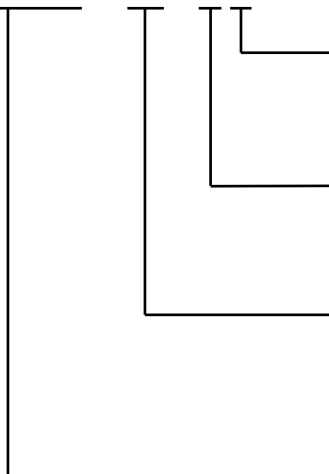

### Connectors Type

- 1: Removable 5mm Screw Terminal
- 2: Fixed 5mm Screw Terminal

### Enclosure Type

- A: 1M, 35mm DIN Rail mounting
- B: 4M, 35mm DIN Rail mounting

### BACnet type

- IP: BACnet/IP
- MSTP: BACnet MS/TP
- PTP: BACnet PTP

### Device Family

HD67678: BACnet slave / CANopen - Converter

- Order Code: **HD67678-IP-A1** - BACnet/IP slave / CANopen - Converter
- Order Code: **HD67678-MSTP-A1** - BACnet MS/TP slave / CANopen - Converter
- Order Code: **HD67678-MSTP-B2** - BACnet MS/TP slave / CANopen - Converter
- Order Code: **HD67678-PTP-A1** - BACnet PTP slave / CANopen - Converter
- Order Code: **HD67678-PTP-B2** - BACnet PTP slave / CANopen - Converter

## ACCESSORIES:

- Order Code: **AC34001** - 35mm Rail DIN - Power Supply 220/240V AC 50/60Hz - 12 V AC
- Order Code: **AC34002** - 35mm Rail DIN - Power Supply 110V AC 50/60Hz - 12 V AC

**DISCLAIMER:**

All technical content within this document can be modified without notice. The content of the document is a under continual renewal. For losses due to fire, earthquake, third party access or other accidents, or intentional or accidental abuse, misuse, or use under abnormal conditions repairs are charged to the user. ADFweb.com S.r.l. will not be liable for accidental loss of use or inability to use this product, such as loss of business income. ADFweb.com S.r.l. shall not be liable for consequences of improper use.

**OTHER REGULATIONS AND STANDARDS:****WEEE INFORMATION**

Disposal of old electrical and electronic equipment (as in the European Union and other European countries with separate collection systems).

— This symbol on the product or on its packaging indicates that this product may not be treated as household rubbish. Instead, it should be taken to an applicable collection point for the recycling of electrical and electronic equipment. If the product is disposed correctly, you will help prevent potential negative environmental factors and impact of human health, which could otherwise be caused by inappropriate disposal. The recycling of materials will help to conserve natural resources. For more information about recycling this product, please contact your local city office, your household waste disposal service or the shop where you purchased the product.

**RESTRICTION OF HAZARDOUS SUBSTANCES DIRECTIVE**

The device respects the 2002/95/EC Directive on the restriction of the use of certain hazardous substances in electrical and electronic equipment (commonly referred to as Restriction of Hazardous Substances Directive or RoHS).

**CE MARKING**

The product conforms with the essential requirements of the applicable EC directives.



### **WARRANTIES AND TECHNICAL SUPPORT:**

For fast and easy technical support for your ADFweb.com SRL products, consult our internet support at [www.adfweb.com](http://www.adfweb.com).  
Otherwise contact us at the address [support@adfweb.com](mailto:support@adfweb.com)

### **RETURN POLICY:**

If while using your product you have any problem and you wish to exchange or repair it, please do the following:

- Obtain a Product Return Number (PRN) from our internet support at [www.adfweb.com](http://www.adfweb.com). Together with the request, you need to provide detailed information about the problem.
- Send the product to the address provided with the PRN, having prepaid the shipping costs (shipment costs billed to us will not be accepted).

If the product is within the warranty of twelve months, it will be repaired or exchanged and returned within three weeks. If the product is no longer under warranty, you will receive a repair estimate.



**ADFweb.com S.r.l.**  
Via Strada Nuova, 17  
IT-31010 Mareno di Piave  
TREVISO (Italy)  
Phone +39.0438.30.91.31  
Fax +39.0438.49.20.99  
[www.adfweb.com](http://www.adfweb.com)

