

User Manual

Revision 1.000
English

BACnet / J1939 - Converter

(Order Code: HD67685-A1)

for Website information:

www.adfweb.com?Product=HD67685

for Price information:

www.adfweb.com?Price=HD67685-A1

Benefits and Main Features:

- ▶ Very easy to configure
- ▶ Electrical isolation
- ▶ Two BACnet ports
- ▶ Temperature range: -40°C/85°C (-40°F/185°F)

Other
Products →



For others BACnet products see also the following link:

Converter BACnet to

- www.adfweb.com?Product=HD67056
- www.adfweb.com?Product=HD67671
- www.adfweb.com?Product=HD67672
- www.adfweb.com?Product=HD67673
- www.adfweb.com?Product=HD67674
- www.adfweb.com?Product=HD67675
- www.adfweb.com?Product=HD67676
- www.adfweb.com?Product=HD67677
- www.adfweb.com?Product=HD67678
- www.adfweb.com?Product=HD67679
- www.adfweb.com?Product=HD67680
- www.adfweb.com?Product=HD67681
- www.adfweb.com?Product=HD67682
- www.adfweb.com?Product=HD67683
- www.adfweb.com?Product=HD67684

- (M-Bus Master)**
- (Modbus Master)**
- (Modbus Slave)**
- (Modbus TCP Master)**
- (Modbus TCP Slave)**
- (PROFIBUS Master)**
- (PROFIBUS Slave)**
- (CAN)**
- (CANopen)**
- (PROFINET)**
- (DeviceNet Master)**
- (DeviceNet Slave)**
- (EtherNet/IP)**
- (NMEA 2000)**
- (Ethernet)**

Do you have an your customer protocol?

www.adfweb.com?Product=HD67003

Do you need to choose a device? do you want help?

www.adfweb.com?Cmd=helpme

INDEX:

	Page
INDEX	2
UPDATED DOCUMENTATION	2
REVISION LIST	2
WARNING	2
TRADEMARKS	2
SECURITY ALERT	3
EXAMPLE OF CONNECTION	4
CONNECTION SCHEME	5
CHARACTERISTICS	6
CONFIGURATION	6
POWER SUPPLY	7
FUNCTION MODES	8
LEDS	9
J1939	10
BACNET	11
USE OF COMPOSITOR SW67685	12
NEW PROJECT / OPEN PROJECT	12
SET COMMUNICATION	13
RECEIVE FRAMES	14
SEND FRAMES	15
SET BACNET ACCESS	16
OBJECTS MAP	17
UPDATE DEVICE	18
MECHANICAL DIMENSIONS	20
ORDERING INFORMATIONS	21
ACCESSORIES	21
DISCLAIMER	22
OTHER REGULATIONS AND STANDARDS	22
WARRANTIES AND TECHNICAL SUPPORT	23
RETURN POLICY	23

UPDATED DOCUMENTATION:

Dear customer, we thank you for your attention and we remind you that you need to check that the following document is:

- Updated
- Related to the product you own

To obtain the most recently updated document, note the "document code" that appears at the top right-hand corner of each page of this document.

With this "Document Code" go to web page www.adfweb.com/download/ and search for the corresponding code on the page. Click on the proper "Document Code" and download the updates.

To obtain the updated documentation for the product that you own, note the "Document Code" (Abbreviated written "Doc. Code" on the label on the product) and download the updated from our web site www.adfweb.com/download/

REVISION LIST:

Revision	Date	Author	Chapter	Description
1.000	15/07/2013	FI	All	First Release

WARNING:

ADFweb.com reserves the right to change information in this manual about our product without warning.
ADFweb.com is not responsible for any error this manual may contain.

TRADEMARKS:

All trademarks mentioned in this document belong to their respective owners.

SECURITY ALERT:**GENERAL INFORMATION**

To ensure safe operation, the device must be operated according to the instructions in the manual. When using the device are required for each individual application, legal and safety regulation. The same applies also when using accessories.

INTENDED USE

Machines and systems must be designed so the faulty conditions do not lead to a dangerous situation for the operator (i.e. independent limit switches, mechanical interlocks, etc.).

QUALIFIED PERSONNEL

The device can be used only by qualified personnel, strictly in accordance with the specifications. Qualified personnel are persons who are familiar with the installation, assembly, commissioning and operation of this equipment and who have appropriate qualifications for their job.

RESIDUAL RISKS

The device is state of the art and is safe. The instrument can represent a potential hazard if they are inappropriately installed and operated by personnel untrained. These instructions refer to residual risks with the following symbol:

 This symbol indicates that non-observance of the safety instructions is danger for people to serious injury or death and / or the possibility of damage.

CE CONFORMITY

The declaration is made by us. You can send an email to support@adfweb.com or give us a call if you need it.

EXAMPLE OF CONNECTION:

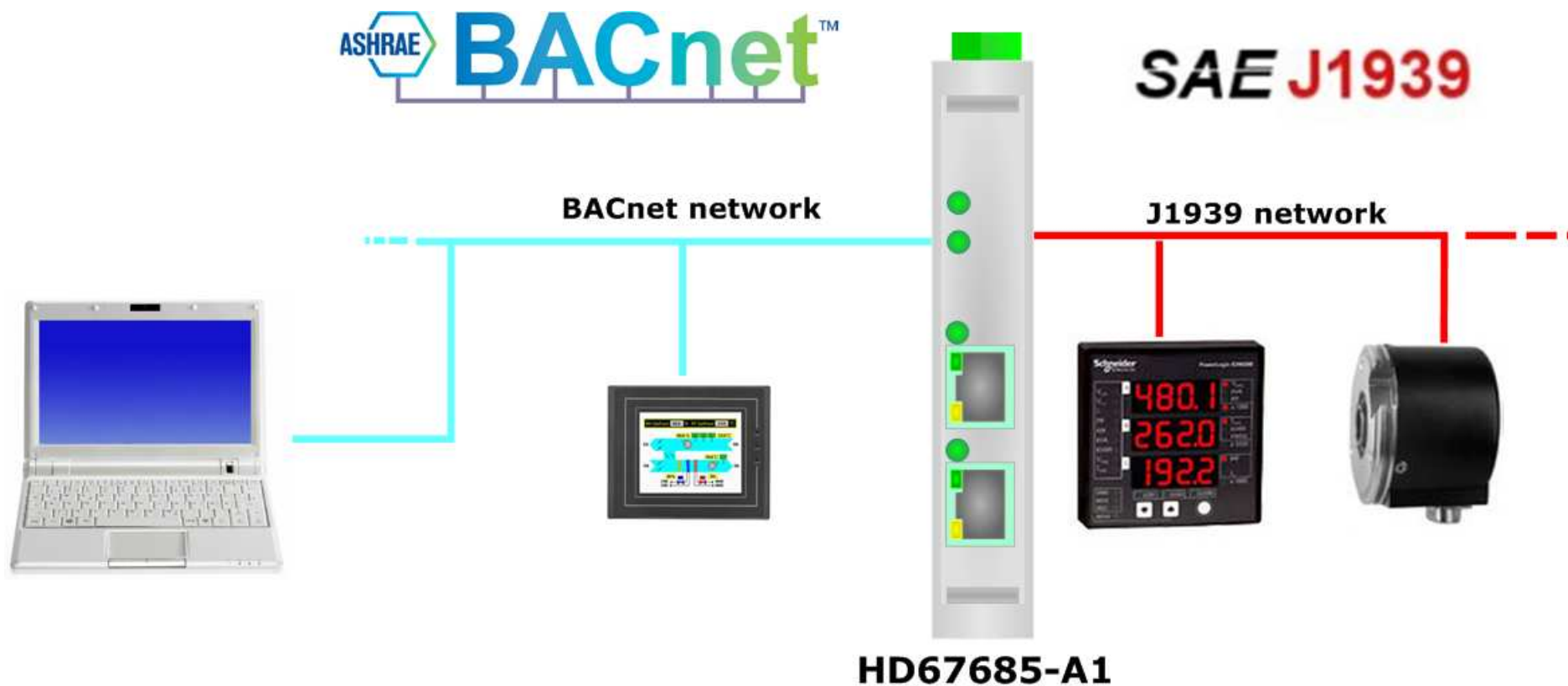

CONNECTION SCHEME:

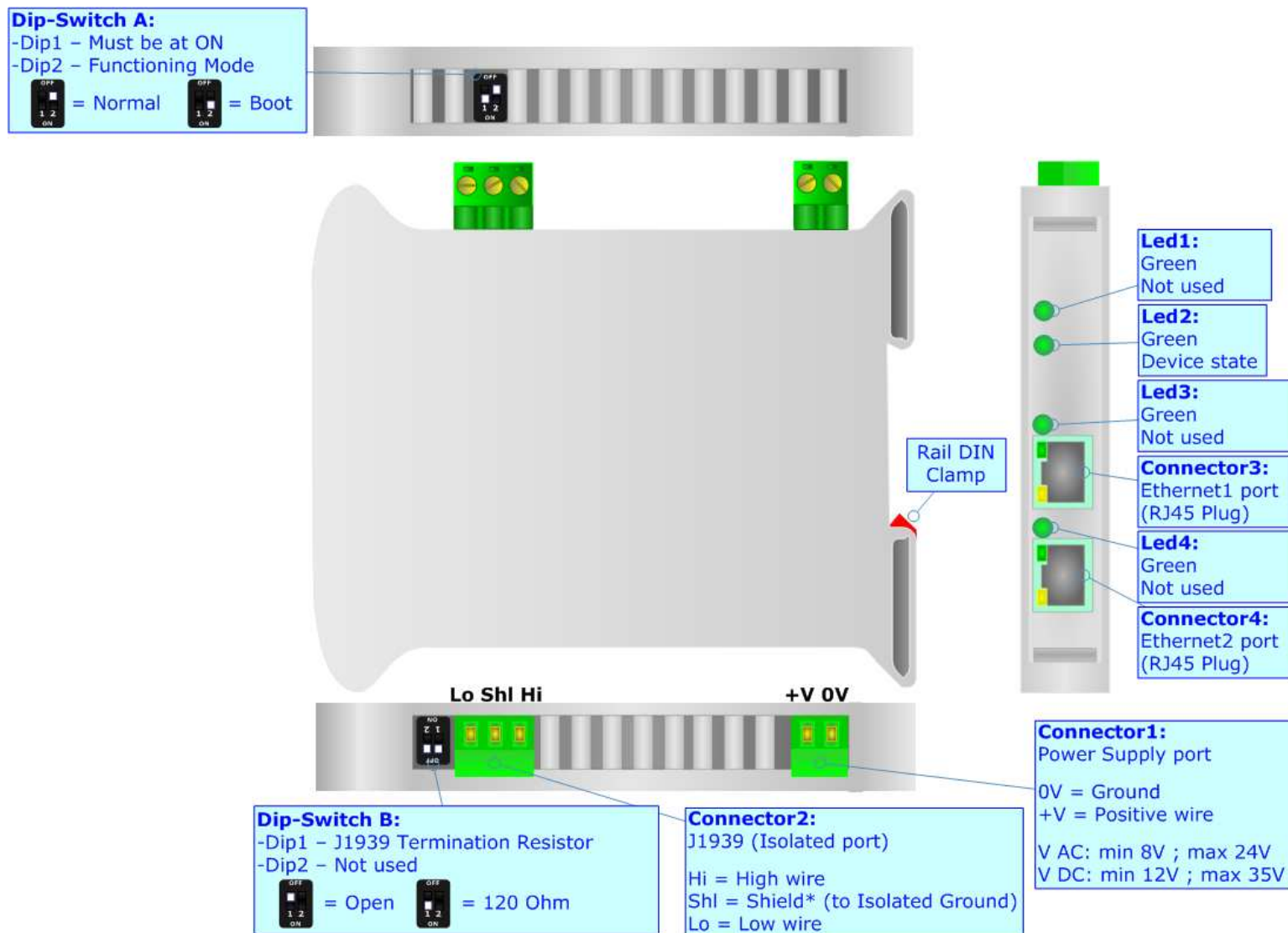

Figure 1: Connection scheme for HD67685-A1

CHARACTERISTICS:

The HD67685-A1 is a BACnet / J1939 Converter.

It allows the following characteristics:

- Up to 2048 BACnet objects (Read+Write);
- Triple isolation between BACnet - Power Supply, BACnet - J1939, Power Supply - J1939.
- Two-directional information between BACnet bus and J1939bus;
- Mountable on 35mm Rail DIN;
- Wide power supply input range: 8...24V AC or 12...35V DC;
- Wide temperature range: -40°C / 85°C [-40°F / +185°F].



CONFIGURATION:

You need Compositor SW67685 software on your PC in order to perform the following:

- Define the parameter of BACnet line;
- Define the parameter of J1939line;
- Determinate which BACnet bytes transfer in J1939and vice versa;
- Update the device.

POWER SUPPLY:

The devices can be powered at 8...24V AC and 12...35V DC. For more details see the two tables below.

VAC 		VDC 	
Vmin	Vmax	Vmin	Vmax
8V	24V	12V	35V

Consumption at 24V DC:

Device	Consumption [W/VA]
HD67685-A1	3.5

Connector1:
 Power Supply port
 0V = Ground
 +V = Positive wire
 V AC: min 8V ; max 24V
 V DC: min 12V ; max 35V

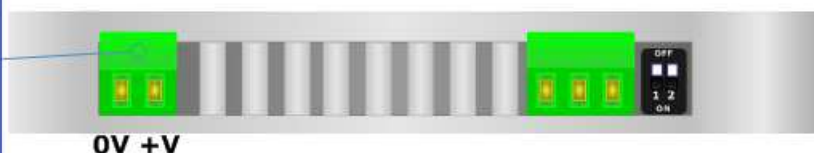

Caution: Not reverse the polarity power

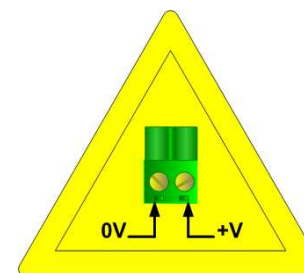

HD67685-A1

FUNCTION MODES:

The device has got two functions mode depending of the position of the 'Dip2 of Dip-Switch A':

- The first, with 'Dip2 of Dip-Switch A' at "OFF" position, is used for the normal working of the device.
- The second, with 'Dip2 of Dip-Switch A' at "ON" position, is used for upload the Project and/or Firmware.

For the operations to follow for the updating, see 'UPDATE DEVICE' section.

According to the functioning mode, the LEDs will have specifics functions, see 'LEDS' section.

**Warning:**

Dip1 of 'Dip-Switch A' must be at ON position for working even if the Ethernet cable isn't inserted.

LEDS:

The device has got four LEDs that are used to give information of the functioning status. The various meanings of the LEDs are described in the table below.

LED	Normal Mode	Boot Mode
1: Not used (green)	OFF	Blinks quickly: Boot state Blinks very slowly (~0.5Hz): update in progress
4: Device State (green)	Blinks slowly (~1Hz)	Blinks quickly: Boot state Blinks very slowly (~0.5Hz): update in progress
5: Not used (green)	OFF	Blinks quickly: Boot state Blinks very slowly (~0.5Hz): update in progress
6: Not used (green)	OFF	Blinks quickly: Boot state Blinks very slowly (~0.5Hz): update in progress

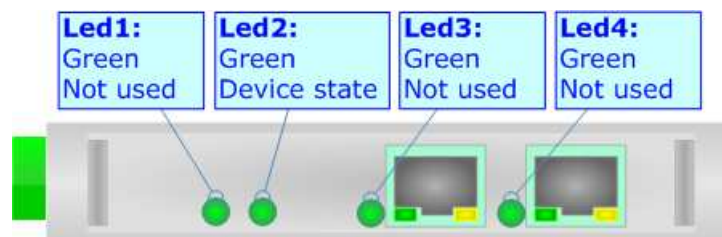

J1939:

To terminate the J1939 line with a 120Ω resistor it is necessary that the Dip1 of 'Dip-Switch B' is at ON position.

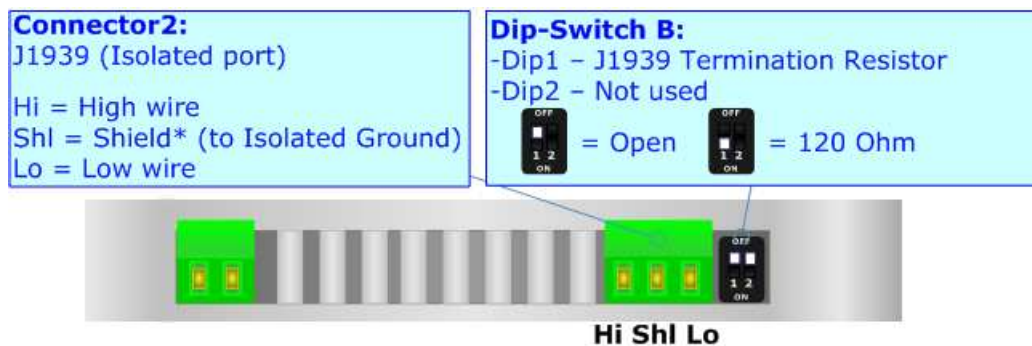

Cable characteristics:

DC parameter:	Impedance	70 Ohm/m
AC parameters:	Impedance	120 Ohm/m
	Delay	5 ns/m
Length	Baud Rate [bps]	Length MAX [m]
	10 K	5000
	20 K	2500
	50 K	1000
	100 K	650
	125 K	500
	250 K	250
	500 K	100
	800 K	50
	1000 K	25

BACNET:

The BACnet connection must be made using Connector3 and/or Connector4 of HD67685-A1 with at least a Category 5E cable. The maximum length of the cable should not exceed 100m. The cable has to conform to the T568 norms relative to connections in cat.5 up to 100 Mbps. To connect the device to an Hub/Switch is recommended the use of a straight cable, to connect the device to a PC/PLC/other is recommended the use of a cross cable.

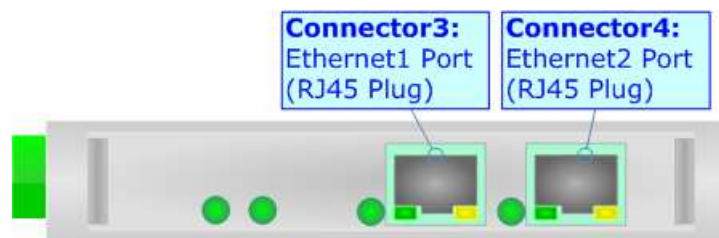

USE OF COMPOSITOR SW67685:

To configure the Converter, use the available software that runs with Windows, called SW67685. It is downloadable on the site www.adfweb.com and its operation is described in this document. (This manual is referenced to the last version of the software present on our web site). The software works with MSWindows (MS 2000, XP, Vista, Seven, 8; 32/64bit).

When launching the SW67685 the right window appears (Fig. 2).

 **Note:**
It is necessary to have installed .Net Framework 4.

Figure 2: Main window for SW67685

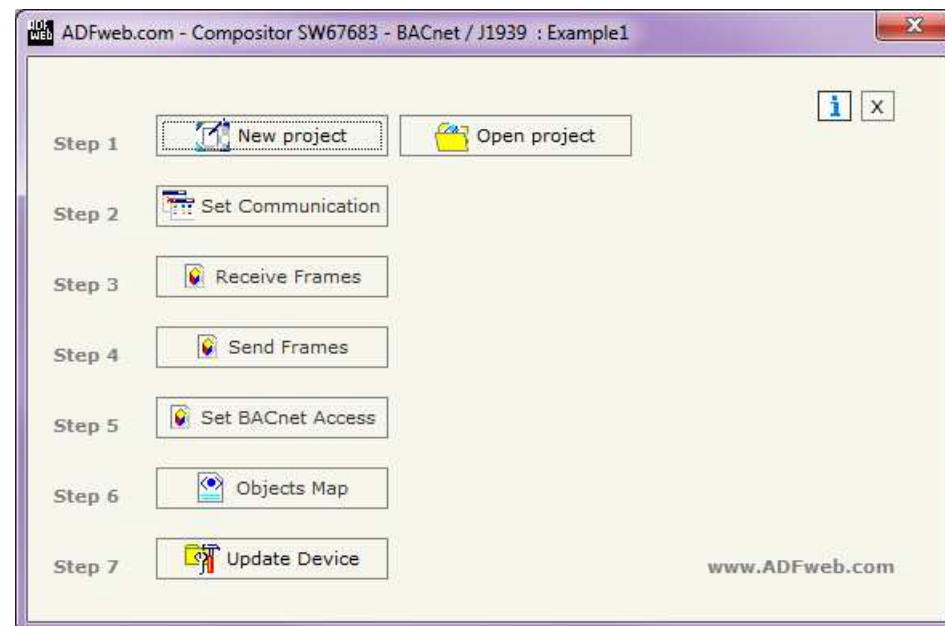

NEW PROJECT / OPEN PROJECT:

The “**New Project**” button creates the folder which contains the entire device configuration.

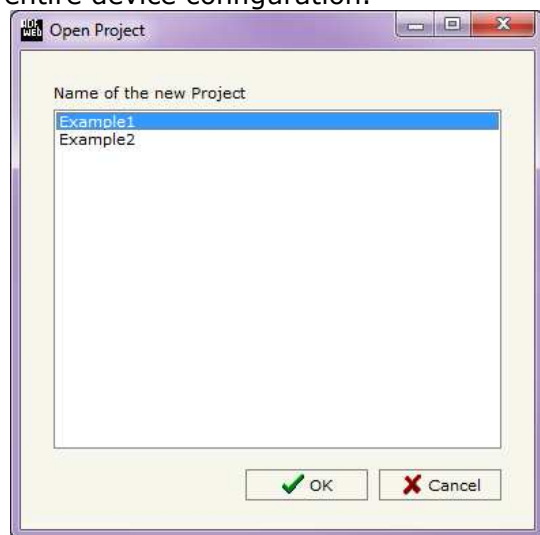

A device configuration can also be imported or exported:

- To clone the configurations of a programmable “BACnet / J1939 – Converter” in order to configure another device in the same manner, it is necessary to maintain the folder and all its contents;
- To clone a project in order to obtain a different version of the project, it is sufficient to duplicate the project folder with another name and open the new folder with the button “**Open Project**”.

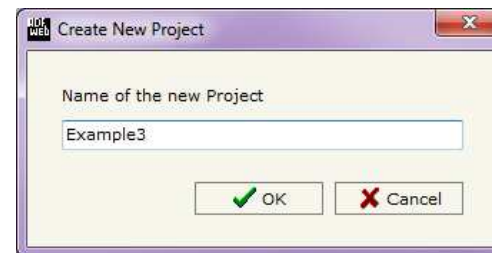

SET COMMUNICATION:

This section define the fundamental communication parameters of two buses, BACnet and J1939.

By Pressing the "**Set Communication**" button from the main window for SW67685 (Fig. 2) the window "Set Communication" appears (Fig. 3).

The window is divided in two sections, one for the BACnet and the other for the J1939.

The means of the fields for "BACnet" are:

- In the fields "**IP ADDRESS**" insert the IP address that you want to give to the Converter;
- In the fields "**SUBNET Mask**" insert the SubNet Mask;
- In the fields "**GATEWAY**" insert the default gateway that you want to use. This feature can be enabled or disabled pressing the Check Box field. This feature is used for going out of the net;
- In the field "**Port**" the port used for BACnet communication is defined. The port has a fixed value of 47808;
- In the field "**BACnet Device Name**" is possible to assign a name to the BACnet node;
- In the field "**Device Identifier**" is possible to assign a number to the BACnet node (Used for the Device Identifier).

The means of the fields for the "J1939" section are:

- In the field "**Baudrate**" the baudrate for the J1939 is defined;
- In the field "**TimeOut Data (s)**" insert a time, when this time is elapsed the data of J1939 frame will be cancel;
- If the field "**Enable Peer to Peer**" is checked the gateway accept any ID that have the PGN inserted in the section "Receive Frames".

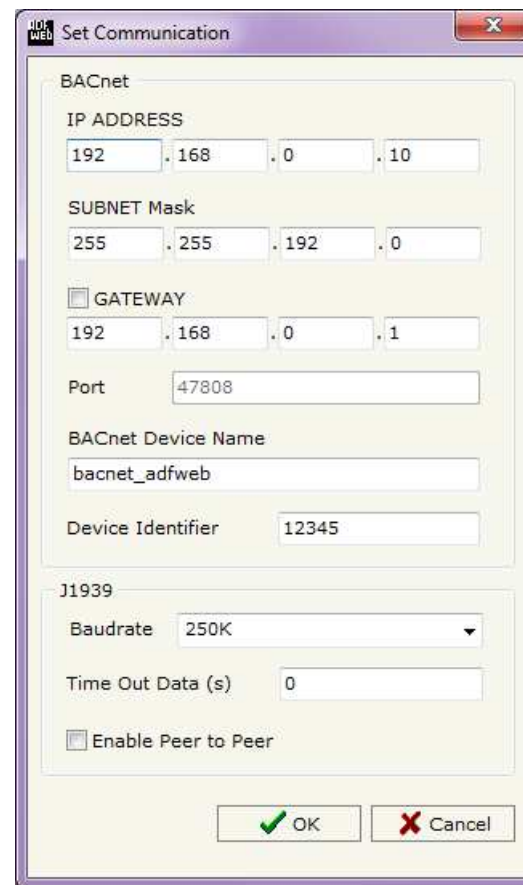

The screenshot shows a window titled "Set Communication" with a close button (X) in the top right corner. The window is divided into two main sections: "BACnet" and "J1939".

BACnet Section:

- IP ADDRESS:** Four input fields containing "192", ".168", ".0", and ".10".
- SUBNET Mask:** Four input fields containing "255", ".255", ".192", and ".0".
- GATEWAY:** A checkbox labeled "GATEWAY" is unchecked. Below it are four input fields containing "192", ".168", ".0", and ".1".
- Port:** A single input field containing "47808".
- BACnet Device Name:** A text input field containing "bacnet_adfweb".
- Device Identifier:** A text input field containing "12345".

J1939 Section:

- Baudrate:** A dropdown menu showing "250K".
- Time Out Data (s):** A text input field containing "0".
- Enable Peer to Peer:** A checkbox is unchecked.

At the bottom right of the window are two buttons: "OK" with a green checkmark icon and "Cancel" with a red X icon.

Figure 3: "Set Communication" window

RECEIVE FRAMES:

By pressing the **Receive Frames** button from the main window for SW67685 (Fig. 2) the window "Receive J1939 Frames" appears (Fig. 4).

The data of the columns have the following meanings:

- In the field **PGN** insert the PGN of the data you would like to read from BACnet to J1939, this field include also the DataPage (it is an identifier);
- In the field **Source Address** insert the address of the device that sends the frame;
- If the field **Transport Protocol** is checked the frame use transport protocol functions;
- In the field **StartByte** insert the byte which you would start read, this field is enable only when the field Transport Protocol or Fast Packet or both are checked;
- In the field **N° Byte** insert the number of byte you would read, for example your start byte is 1 an N°byte is 50, you can read the byte from 1 to 50.
- If the field **Cancel Data** is checked, the data in the frame will be erased after the expiration of the "TimeOut Data";
- In the field **Mnemonic** the description for the frame is defined.

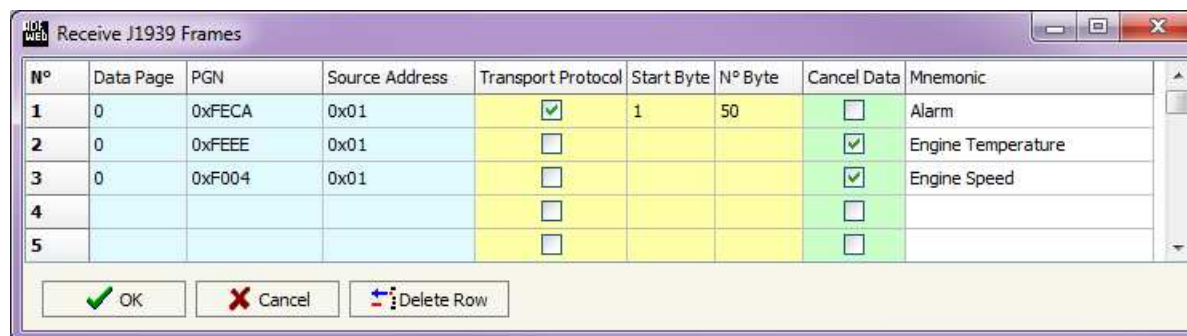

Figure 4: "Receive J1939 Frames" window

It is possible to configure a maximum of 62 frames in the "Receive J1939 Frames" section.

SEND FRAMES:

By pressing the **"Transmit Frames"** button from the main window for SW67685 (Fig. 2) the window "Transmit J1939 Frames" appears (Fig. 5).

The data of the columns have the following meanings:

- In the field **"Priority"** insert the priority of the Frame: in J1939 protocol it is a number among 0,1,2,3,4,5,6,7. The number "0" is the highest priority and "7" is the lowest;
- In the field **"PGN"** insert the PGN of the data you would like to write from BACnet to J1939, this field include also the DataPage (in J1939 protocol the PGN is an identifier);
- In the field **"Source Address"** insert the address of the device that sends the frame;
- If the field **"Transport Protocol"** is checked the Converter use the transport protocol functions;
- In the field **"Num Byte"** the quantity of bytes for the Transport Protocol or Fast Packet Protocol is defined. This field is valid only if the Transport Protocol or Fast Protocol is selected;
- In the field **"Transmission Type"** is possible to select the way to send the frames in the J1939 network. The option are "On Data Change" (the frame will be sent when the data change in the BACnet array), or "On Timer" (the frame will be sent cyclically with a timer defined in the field "Send Timer");
- In the field **"Send Timer"** the timer to send the frame is selected, it is valid only if in the field "Transmission Type" is selected the "On Timer" option;
- In the field **"Mnemonic"** the description for the frame is defined.

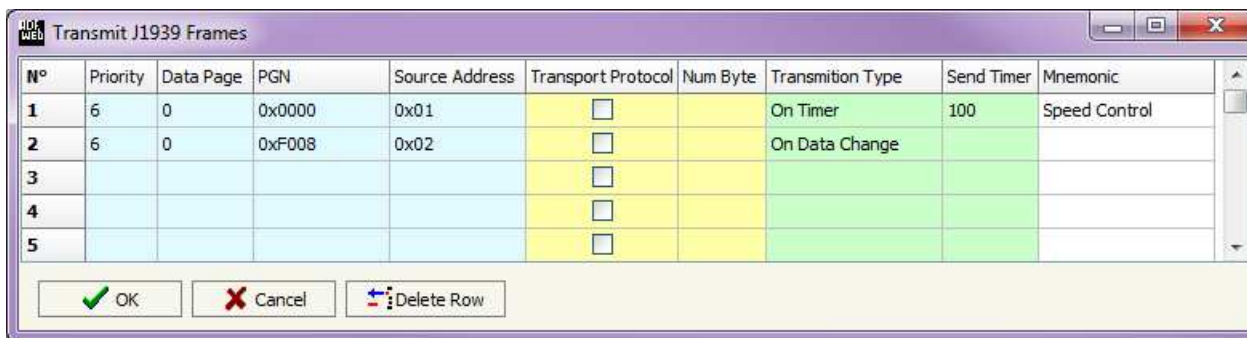

Figure 5: "Transmit J1939 Frames" window

It is possible to configure a maximum of 62 frames in the "Send J1939 Frames" section.

SET BACNET ACCESS:

By Pressing the “**Set BACnet Access**” button from the main window for SW67685 (Fig. 2) the window “BACnet Set Access” appears (Fig. 6).

The window is divided in two parts, the “BACnet in Read” that contains the BACnet objects readable by a BACnet Master and “BACnet in Write” that contains the BACnet objects writeable by a BACnet Master.

The meaning of the fields in the window are the follows:

- In the field “**Data Type**” is possible to select the BACnet object data type;
- In the field “**Eng. Unit**”, with double click the window “*Select the BACnet Engineering Unit*” appears (Fig. 7);
- In the field “**Position**” is possible to select the position where take/save the data from a 6000 bytes array;
- The field “**Start Bit**” is used for the “Binary In” and “Binary Out” BACnet objects;
- The field “**Length**” is used for all the others BACnet objects;
- In the field “**Mnemonic**” the description for the BACnet Object is defined.

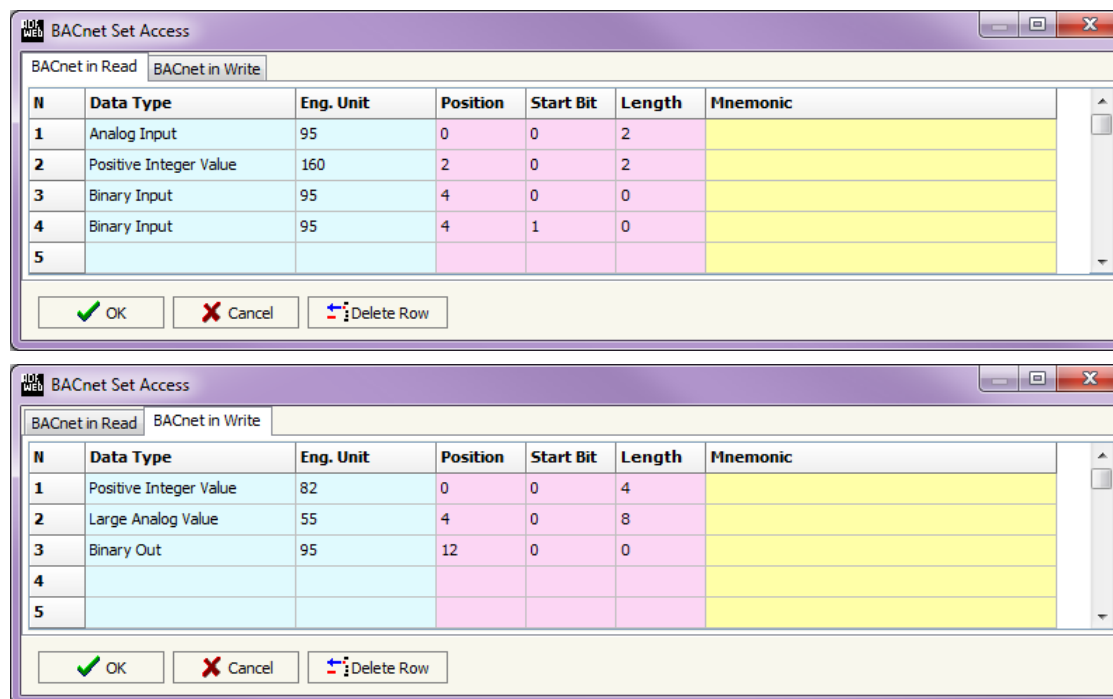

Figure 6: “BACnet Set Access” window

Is possible to insert directly the Unit (using its unique number) by compiling the **"Selected BACnet Engineering Unit"** field; or by selecting with the fields **"Select the Type"** and **"Select unit"** the Type/Unit desired. If the second way is used, is necessary to press the **"Select Engineering Unit"** button for confirm the choice.

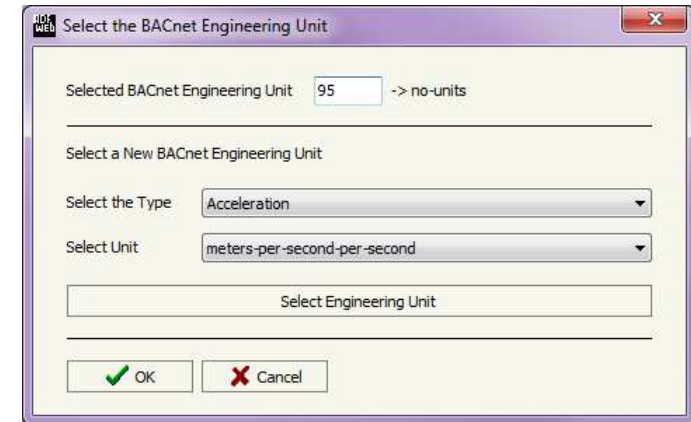

Figure 7: "Select the BACnet Engineering Unit" window

OBJECTS MAP:

By Pressing the **"Objects Map"** button from the main window for SW67685 (Fig. 2) is possible to create a .csv document with the map of BACnet Objects.

UPDATE DEVICE:

By pressing the “**Update Device**” button it is possible to load the created Configuration into the device; and also the Firmware, if is necessary.

If you don't know the actual IP address of the device you have to use this procedure:

- Turn off the Device;
- Put Dip2 of 'Dip-Switch A' at ON position;
- Turn on the device
- Connect the Ethernet cable;
- Insert the IP “**192.168.2.205**”;
- Press the “**Ping**” button, must appear “Device Found!”;
- Press the “**Next**” button;
- Select which operations you want to do;
- Press the “**Execute update firmware**” button to start the upload;
- When all the operations are “OK” turn off the Device;
- Put Dip2 of 'Dip-Switch A' at OFF position;
- Turn on the device.

At this point the configuration/firmware on the device is correctly updated.

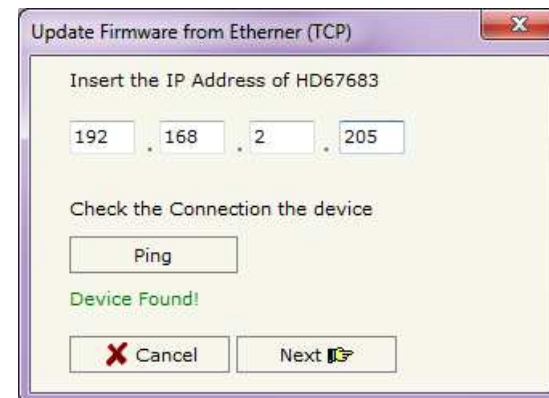

Figure 8: “Update device” windows

If you know the actual IP address of the device you have to use this procedure:

- Turn on the Device with the Ethernet cable inserted;
- Insert the actual IP of the Converter;
- Press the "**Ping**" button, must appear "Device Found!";
- Press the "**Next**" button;
- Select which operations you want to do;
- Press the "**Execute update firmware**" button to start the upload;
- When all the operations are "OK" the device automatically goes at Normal Mode.

At this point the configuration/firmware on the device is correctly update.



Note:

When you install a new version of the software it is better if the first time you do the update of the Firmware in the HD67685-A1 device.



Note:

When you receive the device, for the first time, you have to update also the Firmware in the HD67685-A1 device.



Warning:

If the Fig. 9 appears when you try to do the Update before require assistance try these points:

- Try to repeat the operations for the updating;
- Try with another PC;
- Try to restart the PC;
- If you are using the program inside a Virtual Machine, try to use in the main Operating System;
- If you are using Windows Seven or Vista or 8, make sure that you have the administrator privileges;
- Take attention at Firewall lock;
- Check the LAN settings.

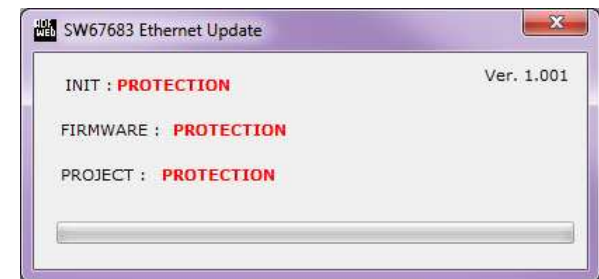
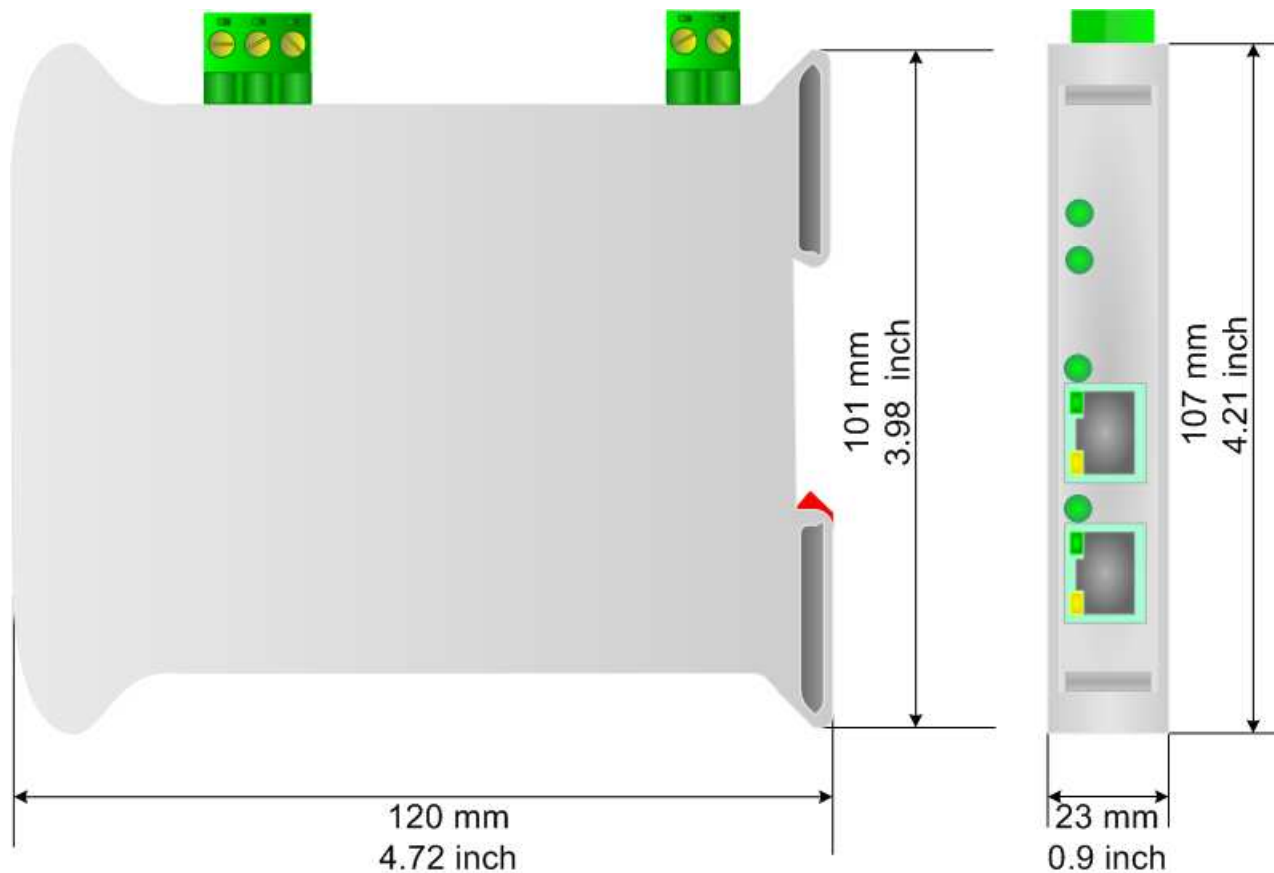

Figure 9: "Protection" window



In the case of HD67685-A1 you have to use the software "SW67685": www.adfweb.com/download/filefold/SW67685.zip.

MECHANICAL DIMENSIONS:



Housing: PVC
Weight: 200g (Approx)

Figure 10: Mechanical dimensions scheme for HD67685-A1

ORDERING INFORMATIONS:

The ordering part number is formed by a valid combination of the following:

HD67685 - A 1

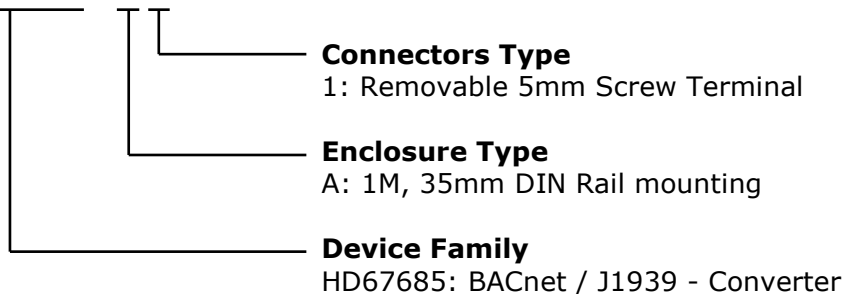

Order Code: **HD67685-A1** - BACnet / J1939 - Converter

ACCESSORIES:

Order Code: **AC34001** - 35mm Rail DIN - Power Supply 220/240V AC 50/60Hz - 12 V AC

Order Code: **AC34002** - 35mm Rail DIN - Power Supply 110V AC 50/60Hz - 12 V AC

DISCLAIMER

All technical content within this document can be modified without notice. The content of the document content is a recurring audit. For losses due to fire, earthquake, third party access or other accidents, or intentional or accidental abuse, misuse, or use under abnormal conditions repairs are charged to the user. ADFweb.com S.r.l. will not be liable for accidental loss of use or inability to use this product, such as loss of business income. ADFweb.com S.r.l. shall not be liable for consequences of improper use.

OTHER REGULATIONS AND STANDARDS

WEEE INFORMATION



Disposal of old electrical and electronic equipment (as in the European Union and other European countries with separate collection systems).

— This symbol on the product or on its packaging indicates that this product may not be treated as household rubbish. Instead, it should be taken to an applicable collection point for the recycling of electrical and electronic equipment. If the product is disposed correctly, you will help prevent potential negative environmental factors and human health, which could otherwise be caused by inappropriate disposal. The recycling of materials will help to conserve natural resources. For more information about recycling this product, please contact your local city office, your household waste disposal service or the shop where you purchased the product.

RESTRICTION OF HAZARDOUS SUBSTANCES DIRECTIVE



The device respects the 2002/95/EC Directive on the restriction of the use of certain hazardous substances in electrical and electronic equipment (commonly referred to as Restriction of Hazardous Substances Directive or RoHS).

CE MARKING



The product conforms with the essential requirements of the applicable EC directives.

WARRANTIES AND TECHNICAL SUPPORT:

For fast and easy technical support for your ADFweb.com SRL products, consult our internet support at www.adfweb.com.
Otherwise contact us at the address support@adfweb.com

RETURN POLICY:

If while using your product you have any problem and you wish to exchange or repair it, please do the following:

- 1) Obtain a Product Return Number (PRN) from our internet support at www.adfweb.com. Together with the request, you need to provide detailed information about the problem.
- 2) Send the product to the address provided with the PRN, having prepaid the shipping costs (shipment costs billed to us will not be accepted).

If the product is within the warranty of twelve months, it will be repaired or exchanged and returned within three weeks. If the product is no longer under warranty, you will receive a repair estimate.