

User Manual

Revision 1.002
English

BACnet Slave / PROFIBUS Slave - Converter

(Order Code: HD67676-IP-A1, HD67676-MSTP-A1)

For Website information:

www.adfweb.com/?Product=HD67676

For Price information:

www.adfweb.com/?Price=HD67676-IP-A1

www.adfweb.com/?Price=HD67676-MSTP-A1

Benefits and Main Features:

- ✦ Very easy to configure
- ✦ PROFIBUS DP-V0 up to 12Mbps
- ✦ Temperature range: -40°C/+85°C (-40°F/+185°F)



For others BACnet Slave products see also the following link:

Converter BACnet to

www.adfweb.com?Product=HD67056
www.adfweb.com?Product=HD67086
www.adfweb.com?Product=HD67170
www.adfweb.com?Product=HD67670
www.adfweb.com?Product=HD67671
www.adfweb.com?Product=HD67672
www.adfweb.com?Product=HD67673
www.adfweb.com?Product=HD67674
www.adfweb.com?Product=HD67675
www.adfweb.com?Product=HD67677
www.adfweb.com?Product=HD67678
www.adfweb.com?Product=HD67679
www.adfweb.com?Product=HD67680
www.adfweb.com?Product=HD67681
www.adfweb.com?Product=HD67682
www.adfweb.com?Product=HD67683
www.adfweb.com?Product=HD67684
www.adfweb.com?Product=HD67685
www.adfweb.com?Product=HD67693
www.adfweb.com?Product=HD67802
www.adfweb.com?Product=HD67833

(M-Bus Master)
(M-Bus Wireless)
(SNMP Manager)
(DMX)
(Modbus Master)
(Modbus Slave)
(Modbus TCP Master)
(Modbus TCP Slave)
(PROFIBUS Master)
(CAN)
(CANopen)
(PROFINET)
(DeviceNet Master)
(DeviceNet Slave)
(EtherNet/IP)
(NMEA 2000)
(Ethernet)
(J1939)
(SNMP Agent)
(KNX)
(DALI)

Do you have an your customer protocol?

www.adfweb.com?Product=HD67003

Do you need to choose a device? do you want help?

www.adfweb.com?Cmd=helpme



User Manual

INDEX:

	Page
INDEX	2
UPDATED DOCUMENTATION	2
REVISION LIST	2
WARNING	2
TRADEMARKS	2
SECURITY ALERT	3
EXAMPLE OF CONNECTION	4
CONNECTION SCHEME	5
CHARACTERISTICS	7
CONFIGURATION	7
POWER SUPPLY	8
FUNCTION MODES	9
LEDS	10
ETHERNET	11
RS485	11
PROFIBUS	12
USE OF COMPOSITOR SW67676	13
NEW PROJECT / OPEN PROJECT	14
SOFTWARE OPTIONS	15
SET COMMUNICATION	17
SET BACNET ACCESS	19
OBJECTS MAP	20
PROFIBUS GSD	20
UPDATE DEVICE	21
MECHANICAL DIMENSIONS	23
ORDERING INFORMATIONS	24
ACCESSORIES	24
DISCLAIMER	25
OTHER REGULATIONS AND STANDARDS	25
WARRANTIES AND TECHNICAL SUPPORT	26
RETURN POLICY	26

UPDATED DOCUMENTATION:

Dear customer, we thank you for your attention and we remind you that you need to check that the following document is:

- ✦ Updated
- ✦ Related to the product you own

To obtain the most recently updated document, note the “document code” that appears at the top right-hand corner of each page of this document.

With this “Document Code” go to web page www.adfweb.com/download/ and search for the corresponding code on the page. Click on the proper “Document Code” and download the updates.

REVISION LIST:

Revision	Date	Author	Chapter	Description
1.000	10/04/2013	Fl	All	First Release
1.001	05/07/2016	Ff	All	New software interface
1.002	27/06/2017	Ff	All	Added MS/TP version

WARNING:

ADFweb.com reserves the right to change information in this manual about our product without warning. ADFweb.com is not responsible for any error this manual may contain.

TRADEMARKS:

All trademarks mentioned in this document belong to their respective owners.

SECURITY ALERT:**GENERAL INFORMATION**

To ensure safe operation, the device must be operated according to the instructions in the manual. When using the device, legal and safety regulation are required for each individual application. The same applies also when using accessories.

INTENDED USE

Machines and systems must be designed so the faulty conditions do not lead to a dangerous situation for the operator (i.e. independent limit switches, mechanical interlocks, etc.).

QUALIFIED PERSONNEL

The device can be used only by qualified personnel, strictly in accordance with the specifications.

Qualified personnel are persons who are familiar with the installation, assembly, commissioning and operation of this equipment and who have appropriate qualifications for their job.

RESIDUAL RISKS

The device is state-of-the-art and is safe. The instruments can represent a potential hazard if they are inappropriately installed and operated by untrained personnel. These instructions refer to residual risks with the following symbol:



This symbol indicates that non-observance of the safety instructions is a danger for people that could lead to serious injury or death and / or the possibility of damage.

CE CONFORMITY

The declaration is made by our company. You can send an email to support@adfweb.com or give us a call if you need it.

EXAMPLES OF CONNECTION:

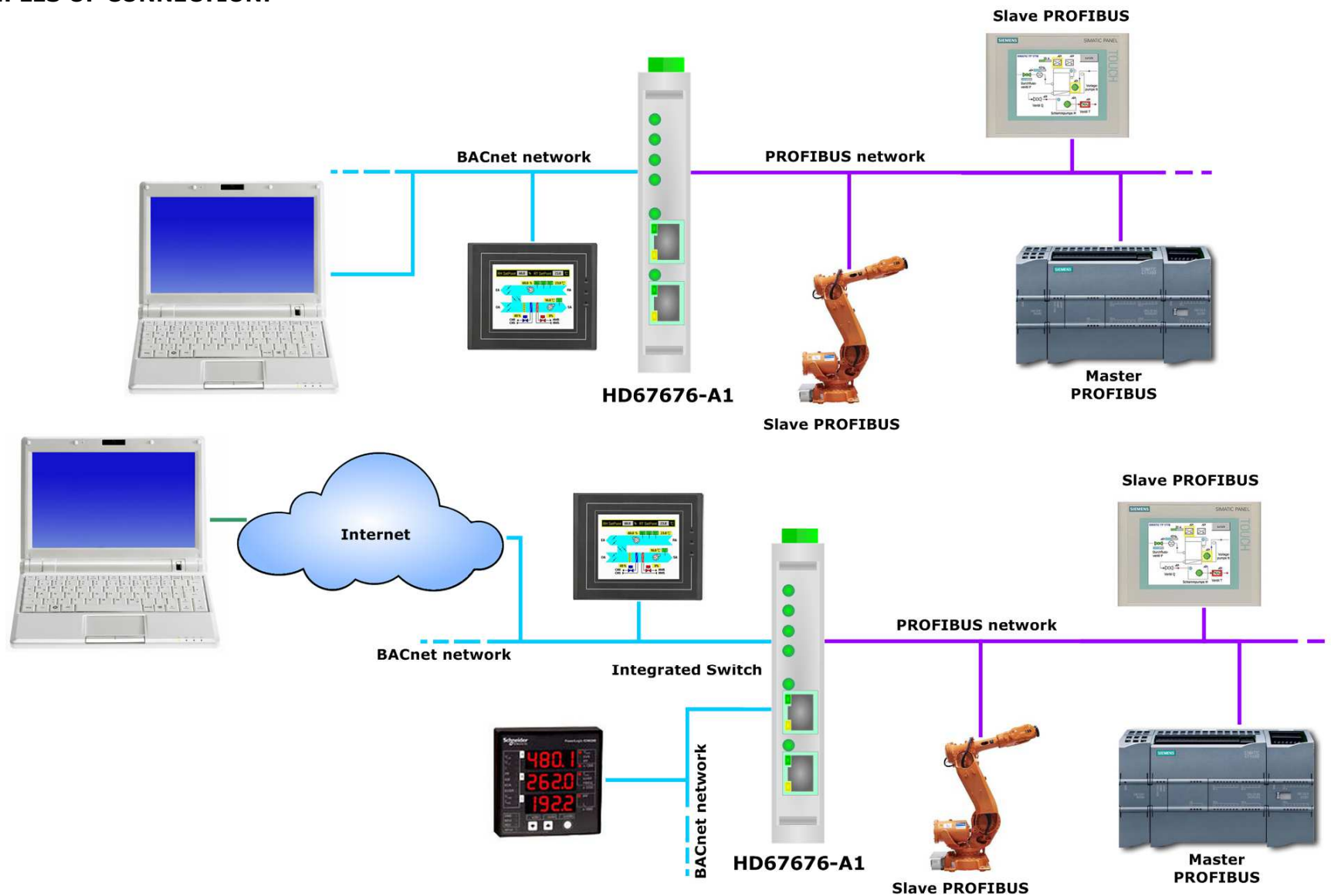

CONNECTION SCHEME:

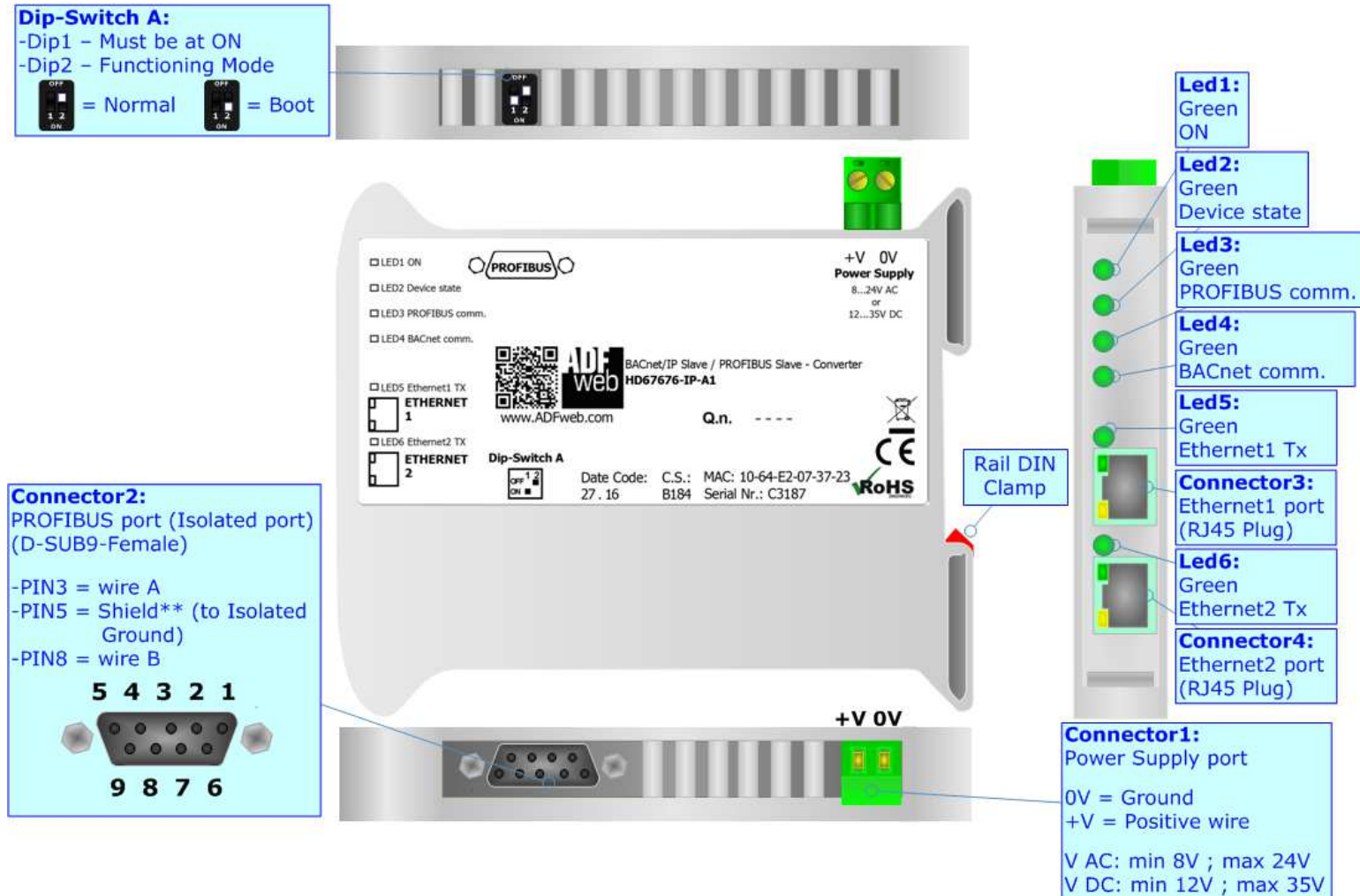

Figure 1a: Connection scheme for HD67676-IP-A1

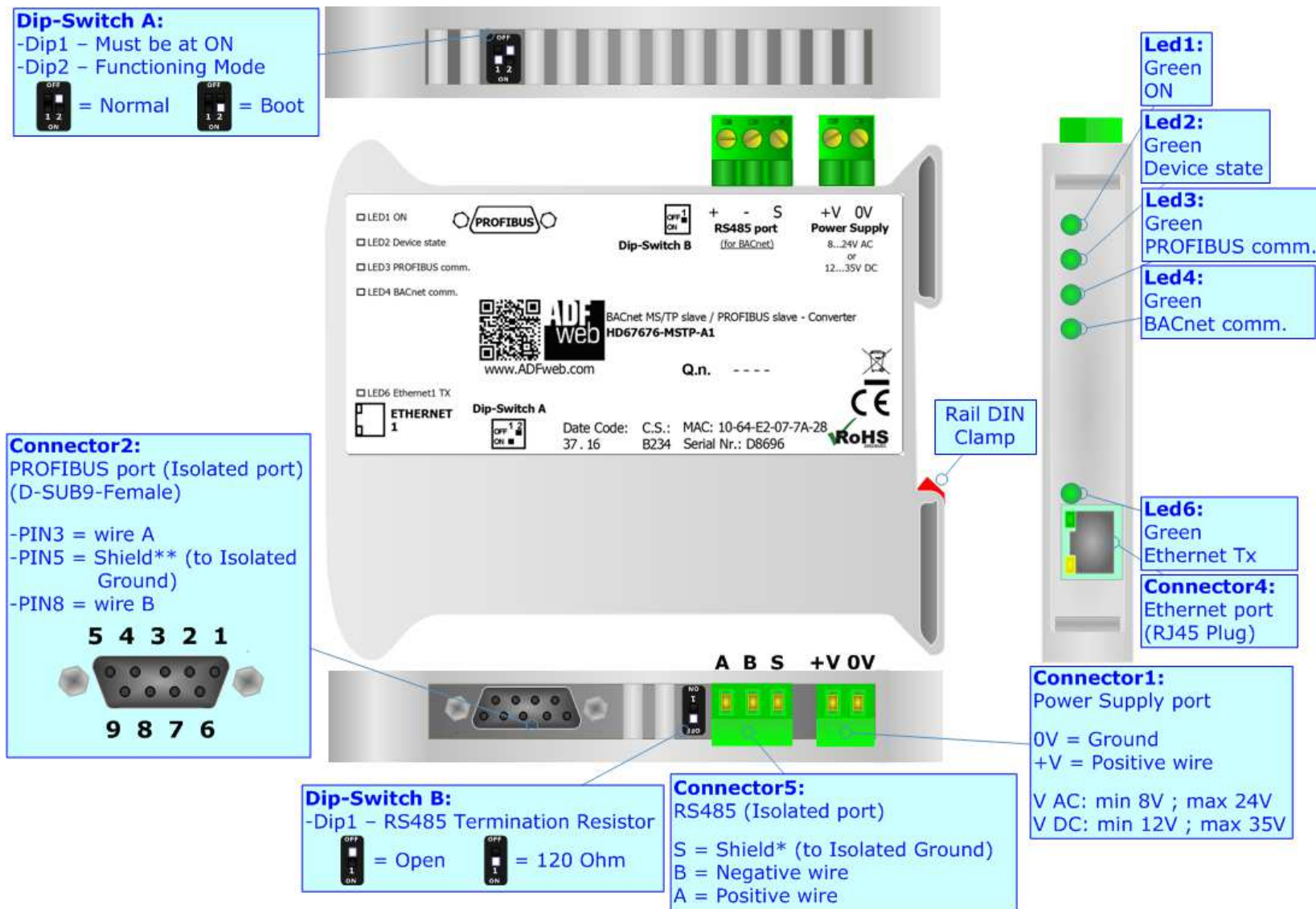

Figure 1b: Connection scheme for HD67676-MSTP-A1

CHARACTERISTICS:

The HD67676 is a BACnet Slave / PROFIBUS Slave Converter.

It allows the following characteristics:

- Up to 2000 BACnet objects (Read+Write);
- Triple isolation between BACnet - Power Supply, BACnet - PROFIBUS, Power Supply - PROFIBUS.
- Two-directional information between BACnet and PROFIBUS;
- Mountable on 35mm Rail DIN;
- Wide power supply input range: 8...24V AC or 12...35V DC;
- Wide temperature range: -40°C / 85°C [-40°F / +185°F].

CONFIGURATION:

You need Compositor SW67676 software on your PC in order to perform the following:

- Define the parameter of BACnet line;
- Define the parameter of PROFIBUS line;
- Define BACnet objects that contains the data arrived from the PROFIBUS Master;
- Define BACnet objects that contains the data to send to the PROFIBUS Master;
- Update the device.

POWER SUPPLY:

The devices can be powered at 8...24V AC and 12...35V DC. For more details see the two tables below.

VAC		VDC	
Vmin	Vmax	Vmin	Vmax
8V	24V	12V	35V

Consumption at 24V DC:

Device	Consumption [W/VA]
HD67676-IP-A1	3.5
HD67676-MSTP-A1	3.5

Connector1:
Power Supply port
0V = Ground
+V = Positive wire
V AC: min 8V ; max 24V
V DC: min 12V ; max 35V

Connector1:
Power Supply port
0V = Ground
+V = Positive wire
V AC: min 8V ; max 24V
V DC: min 12V ; max 35V

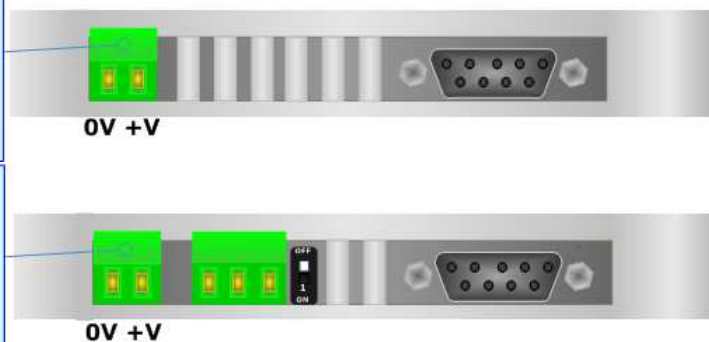

Caution: Not reverse the polarity power

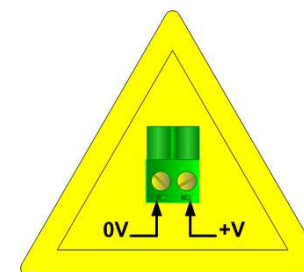

HD67676-IP-A1
HD67676-MSTP-A1

FUNCTION MODES:

The device has got two functions mode depending of the position of the 'Dip2 of Dip-Switch A':

- The first, with 'Dip2 of Dip-Switch A' at "OFF" position, is used for the normal working of the device.
- The second, with 'Dip2 of Dip-Switch A' at "ON" position, is used for upload the Project and/or Firmware.

For the operations to follow for the updating, see 'UPDATE DEVICE' section.

According to the functioning mode, the LEDs will have specifics functions, see 'LEDS' section.

**Warning:**

Dip1 of 'Dip-Switch A' must be at ON position for working even if the Ethernet cable isn't inserted.

LEDS:

The device has got six LEDs that are used to give information of the functioning status. The various meanings of the LEDs are described in the table below.

LED	Normal Mode	Boot Mode
1: ON [supply voltage] (green)	ON: Device powered OFF: Device not powered	Blinks quickly: Boot state Blinks very slowly (~0.5Hz): update in progress
2: Device state (green)	Blinks slowly (~1Hz)	Blinks quickly: Boot state Blinks very slowly (~0.5Hz): update in progress
3: BACnet comm. (green)	Changes state when a BACnet request is received	Blinks quickly: Boot state Blinks very slowly (~0.5Hz): update in progress
4: PROFIBUS comm. (green)	Blinks quickly when PROFIBUS communication is working	Blinks quickly: Boot state Blinks very slowly (~0.5Hz): update in progress
5: Ethernet1 Tx (only for BACnet/IP version)	Blinks when Ethernet frames are transmitted	Blinks quickly: Boot state Blinks very slowly (~0.5Hz): update in progress
6: Ethernet2 Tx	Blinks when Ethernet frames are transmitted	Blinks quickly: Boot state Blinks very slowly (~0.5Hz): update in progress



ETHERNET:

The BACnet/IP connection must be made using Connector3 and/or Connector4 of HD67676-IP-A1 with at least a Category 5E cable. The maximum length of the cable should not exceed 100m. The cable has to conform to the T568 norms relative to connections in cat.5 up to 100 Mbps. To connect the device to an Hub/Switch is recommended the use of a straight cable, to connect the device to a PC/PLC/other is recommended the use of a cross cable.

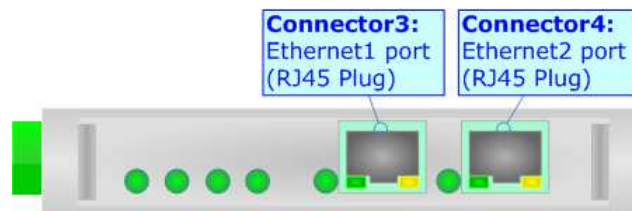

RS485:

The BACnet MS/TP connection must be made using Connector5 of HD67676-MSTP-A1. To terminate the RS485 line with a 120Ω resistor it is necessary to put ON dip 1, like in figure.

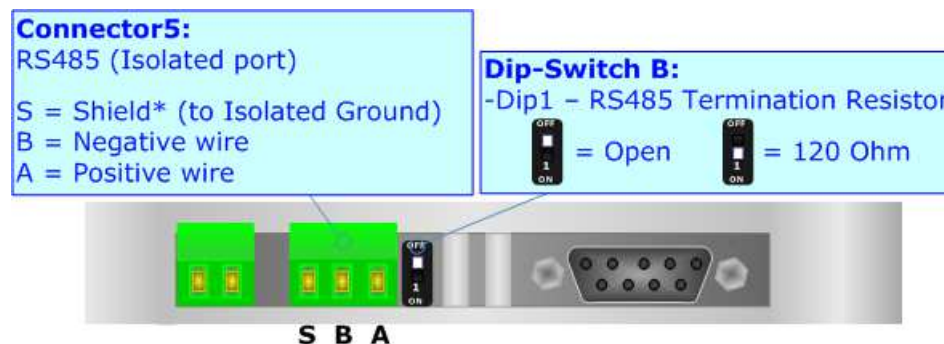

The maximum length of the cable should be 1200m (4000 feet).

Here some codes of cables:

- Belden: p/n 8132 - 2x 28AWG stranded twisted pairs conductor + foil shield + braid shield;
- Belden p/n 82842 - 2x 24AWG stranded twisted pairs conductor + foil shield + braid shield;
- Tasker: p/n C521 - 1x 24AWG twisted pair conductor + foil shield + braid shield;
- Tasker: p/n C522 - 2x 24AWG twisted pairs conductor + foil shield + braid shield.

PROFIBUS:

The PROFIBUS uses a 9-pin D-SUB connector. The pin assignment is defined like in the right figure.

Here some codes of cables:

- Belden: p/n 183079A - Continuous Armor DataBus® ISA/SP-50 PROFIBUS Cable.

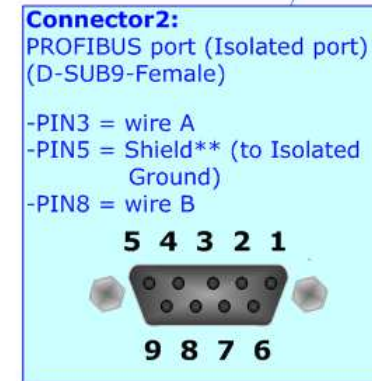

USE OF COMPOSITOR SW67676:

To configure the Converter, use the available software that runs with Windows called SW67676. It is downloadable from the site www.adfweb.com and its operation is described in this document (*this manual is referenced to the last version of the software present on the web site*). The software works with MSWindows (XP, Vista, Seven, 8, 10; 32/64bit).

When launching the SW67676, the window below appears (Fig. 2).



Note:

It is necessary to have installed .Net Framework 4.

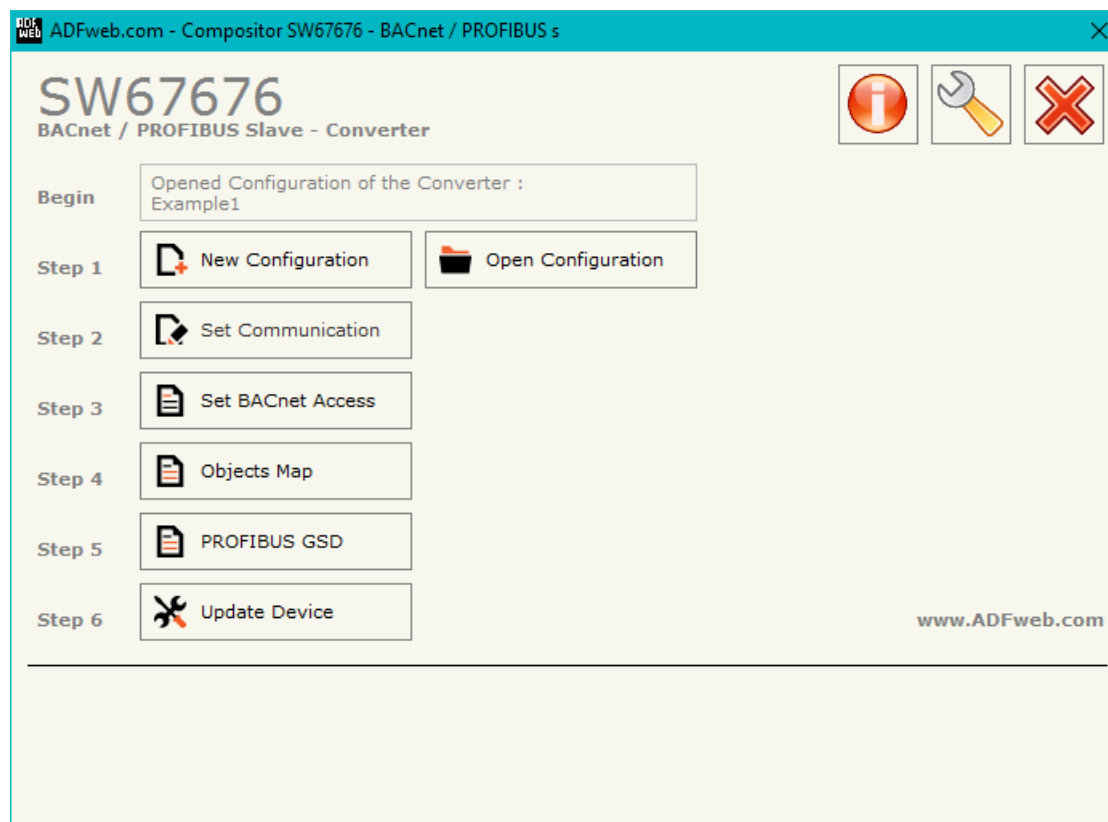
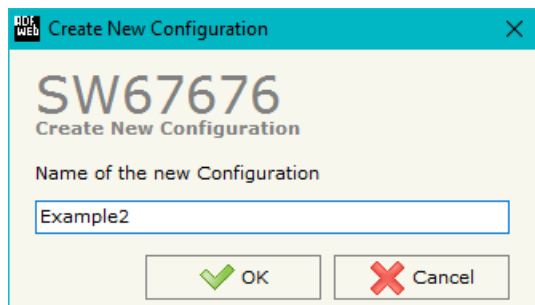

Figure 2: Main window for SW67676

NEW CONFIGURATION / OPEN CONFIGURATION:

The “**New Configuration**” button creates the folder which contains the entire device’s configuration.



A device’s configuration can also be imported or exported:

- To clone the configurations of a programmable “BACnet Slave / PROFIBUS Slave - Converter” in order to configure another device in the same manner, it is necessary to maintain the folder and all its contents;
- To clone a project in order to obtain a different version of the project, it is sufficient to duplicate the project folder with another name and open the new folder with the button “**Open Configuration**”.

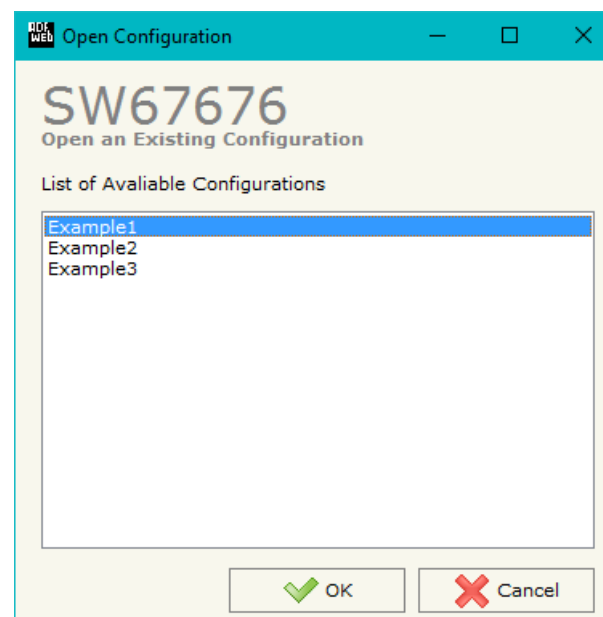

SOFTWARE OPTIONS:

By pressing the “**Settings**” () button there is the possibility to change the language of the software and check the updatings for the compositor.

In the section “Language” it is possible to change the language of the software.

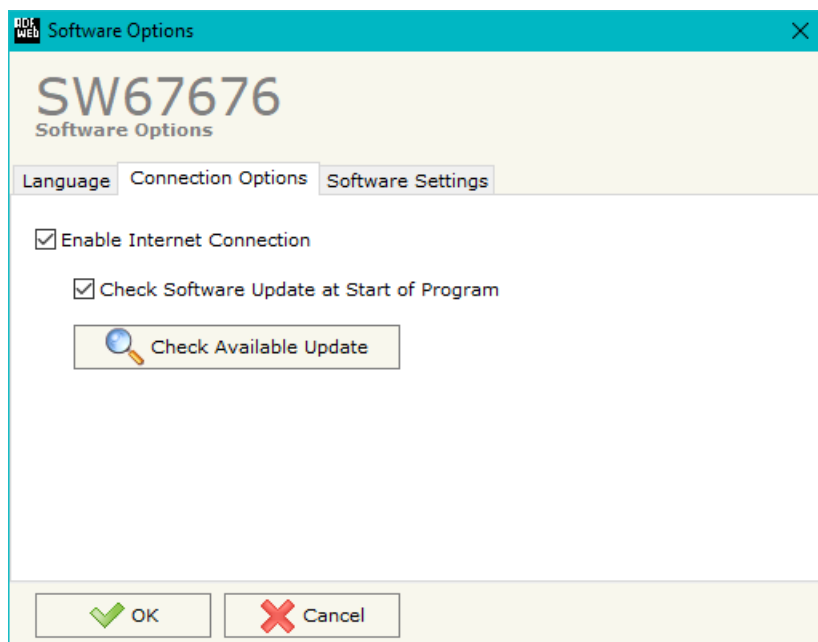

In the section “Connection Options”, it is possible to check if there are some updatings of the software compositor in ADFweb.com website. Checking the option “**Check Software Update at Start of Program**”, the SW67676 check automatically if there are updatings when it is launched.

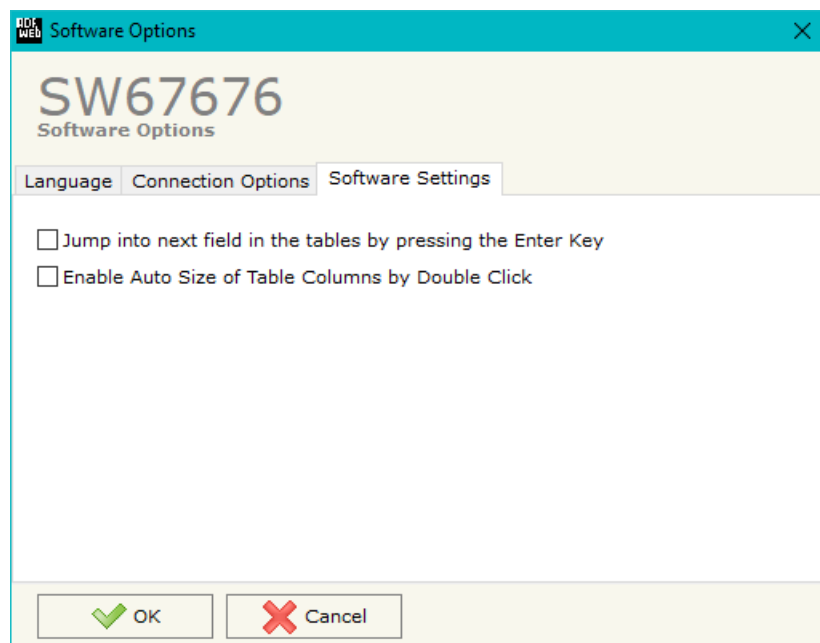

In the section "Software Settings", it is possible to enable/disable some keyboard's commands for an easier navigation inside the tables contained in the different sections of the software.

SET COMMUNICATION:

This section define the fundamental communication parameters of two buses, BACnet and PROFIBUS.

By Pressing the **"Set Communication"** button from the main window for SW67676 (Fig. 2) the window "Set Communication" appears (Fig. 3).

The window is divided in three sections, one for selecting the type of BACnet (in relation to the device used), one for the BACnet parameters and the other for the PROFIBUS parameters.

In the section "BACnet Type" is possible to select the type of BACnet to use from:

- BACnet/IP (uses Ethernet);
- BACnet MS/TP (uses RS485).

The means of the fields for "BACnet" are:

- In the field **"IP ADDRESS"** the IP address of BACnet/IP side of the converter is defined;
- In the field **"SUBNET Mask"** the SubNet Mask of the converter is defined;
- In the field **"GATEWAY"** the default gateway of the net is defined. This feature can be enabled or disabled pressing the Check Box field. This feature is used for going out of the net;
- In the field **"Port"** the port used for BACnet communication is defined;
- In the field **"BACnet Device Name"** the name of the BACnet side of the converter is defined;
- In the field **"Device Identifier"** the identifier of the BACnet side of the converter is defined;
- If the field **"BACnet description up to 32 chars"** is checked, the name of the converter can have a dimension of 32 chars (maximum).

The means of the fields for the "PROFIBUS Slave" section are:

- In the field **"ID Device"** the ID for the PROFIBUS side is defined.
- In the field **"Baudrate"** the baudrate is defined (fixed to 'Auto Baudrate');
- In the field **"Number Byte IN"** the number of input bytes of PROFIBUS side is defined (up to 244 bytes);
- In the field **"Number Byte OUT"** the number of output bytes of PROFIBUS side is defined (up to 244 bytes).

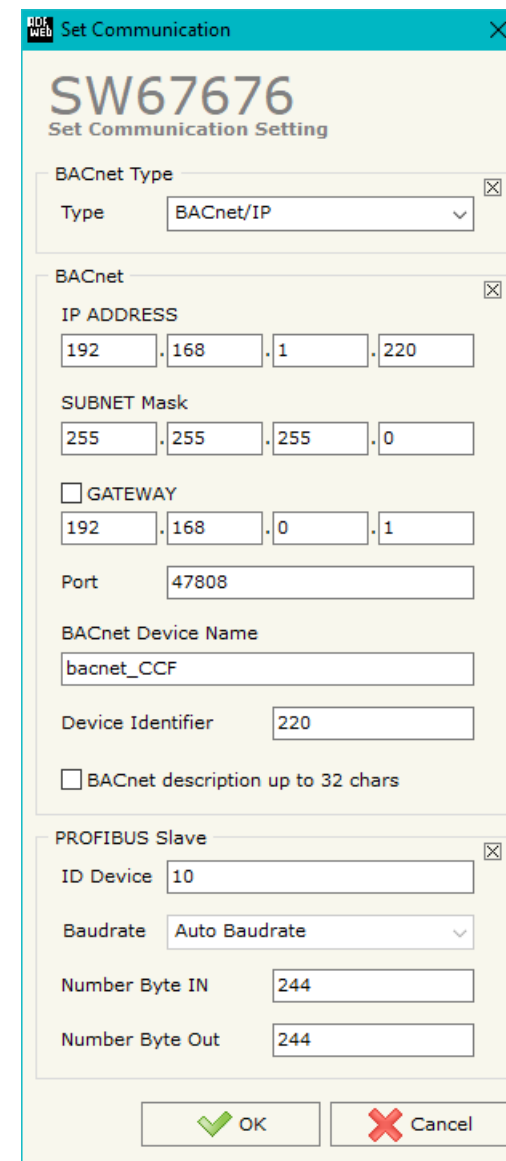

Figure 3: "Set Communication" window

If selected "BACnet MS/TP", the means of the fields for "BACnet" are:

- In the field "**Baudrate**" the data rate of the BACnet line is defined;
- In the field "**Parity**" the parity of the line is defined;
- In the field "**BACnet Device Name**" the name to give to the BACnet node is defined;
- In the field "**MAC Address**" the MAC of BACnet node (from 0 to 254) is defined;
- The field "**Max Master**" specifies the highest allowable address for master nodes. The value shall be less than or equal to 127;
- The field "**Max Info Frames**" specifies the maximum number of information frames the node may send before it must pass the token;
- In the field "**Device Instance**" the of the BACnet MS/TP side of the converter is defined;
- In the field "**Network**" the BACnet MS/TP network number is defined;
- If the field "**BACnet description up to 32 chars**" is checked, the description for the BACnet Objects can be up to 32 chars long.

The means of the fields for the "Ethernet Update" section are:

- In the fields "**IP ADDRESS**" the IP address of the converter is defined;
- In the fields "**SUBNET Mask**" the SubNet Mask of the converter is defined;
- In the fields "**GATEWAY**" the default gateway of the network is defined. This feature can be enabled or disabled pressing the Check Box field. This feature is used for going out of the net.

These information are used for programming the Converter.

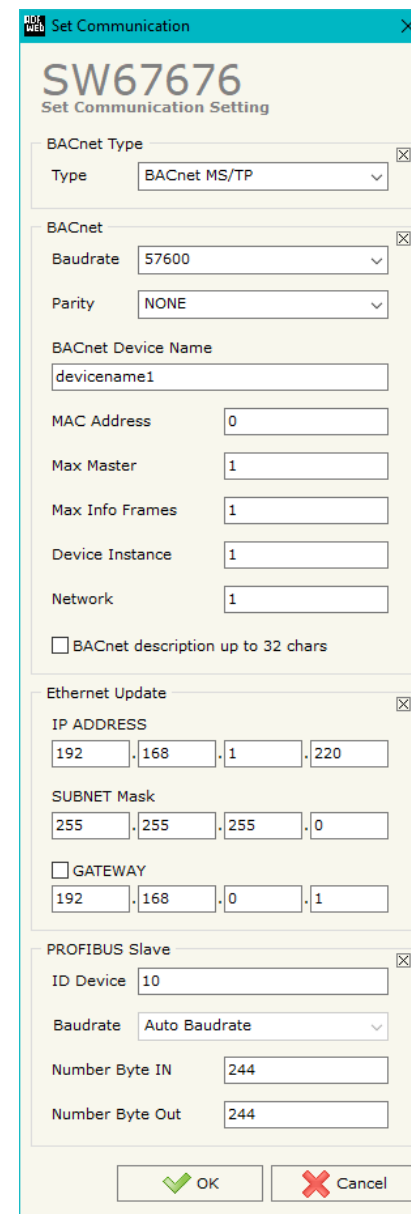

SET BACNET ACCESS:

By Pressing the “**Set BACnet Access**” button from the main window for SW67676 (Fig. 2) the window “BACnet Set Access” appears (Fig. 4).

The window is divided in two parts, the “BACnet in Read” that contains the BACnet objects readable by a BACnet Master (the PROFIBUS data associated to these objects are written by the PROFIBUS Master) and “BACnet in Write” that contains the BACnet objects writable by a BACnet Master (the PROFIBUS data associated to these objects are read by the PROFIBUS Master).

The meaning of the fields in the window are the following:

- In the field “**Data Type**” the BACnet object data type is defined;
- In the field “**Eng. Unit**”, with double click the window “*Select the BACnet Engineering Unit*” appears (Fig. 5);
- In the field “**Position**” the byte where taking/saving the data from the PROFIBUS arrays is defined;
- In the field “**Start Bit**” the bit of the selected Position is defined (used for Binary Objects);
- In the field “**Length**” the dimension in bytes of the BACnet object is defined (on “BACnet in Write” this field isn’t editable);
- If the field “**Swap**” is checked, the bytes from/to the BACnet Objects will be swapped;
- In the field “**Mnemonic**” a description of the Object is defined.

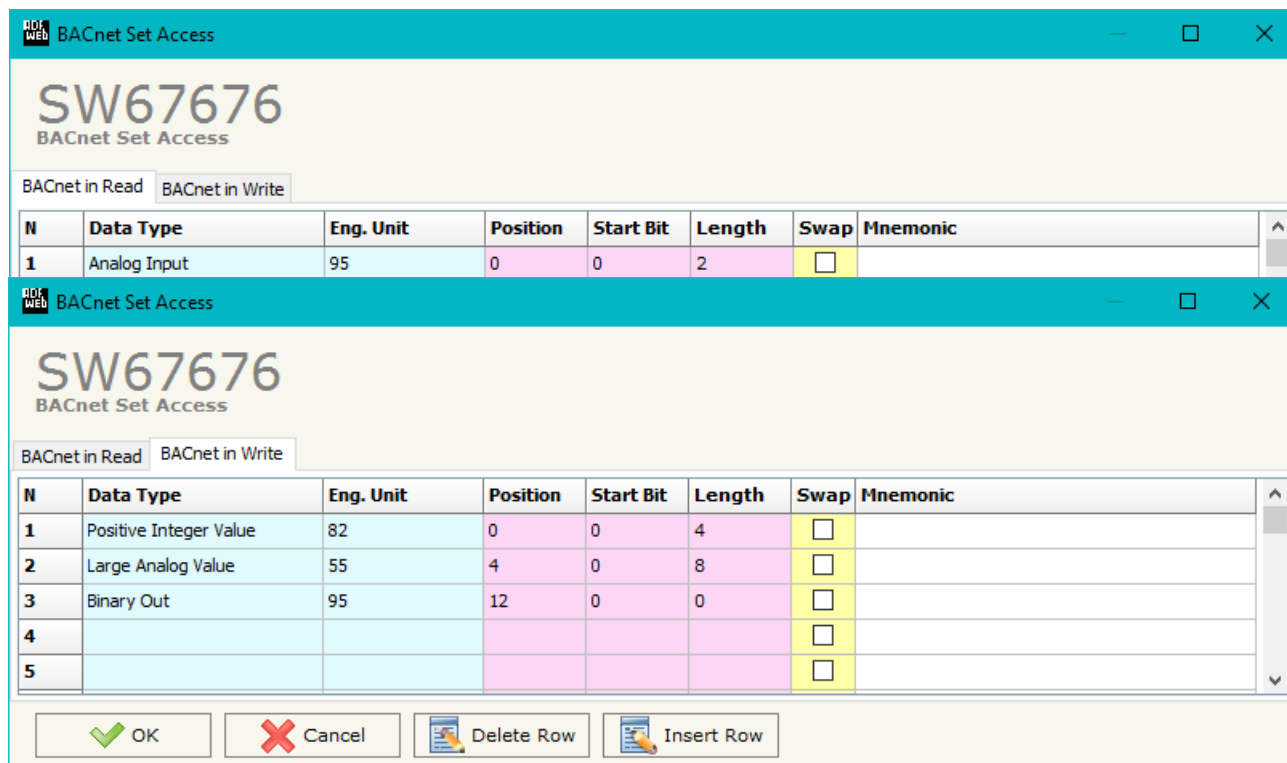

Figure 4: “BACnet Set Access” window

It is possible to insert directly the Unit (using its unique number) by compiling the "**Selected BACnet Engineering Unit**" field; or by selecting with the fields "**Select the Type**" and "**Select unit**" the Type/Unit desired. If the second way is used, is necessary to press the "**Select Engineering Unit**" button for confirm the choice.

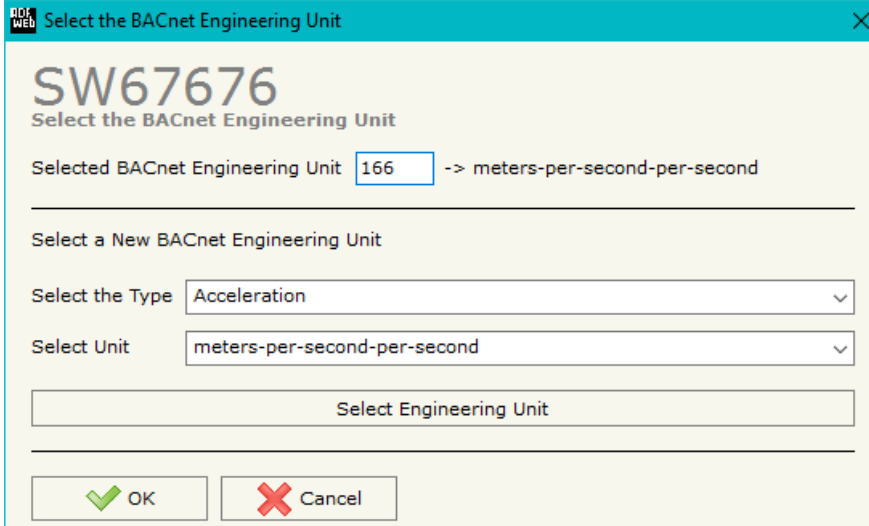

Figure 5: "Select the BACnet Engineering Unit" window

OBJECTS MAP:

By Pressing the "**Objects Map**" button from the main window for SW67676 (Fig. 2) it is possible to create a .csv document with the map of BACnet Objects.

PROFIBUS GSD:

By pressing the "**PROFIBUS GSD**" button it is possible to save the GSD file for the PROFIBUS side. With this feature you can save the configuration of the converter of the PROFIBUS side.



Note:

When you import the .gsd file on your Master PROFIBUS it is necessary to add all the modules that are present inside it.

UPDATE DEVICE:

By pressing the **"Update Device"** button, it is possible to load the created Configuration into the device; and also the Firmware, if necessary.

If you don't know the actual IP address of the device you have to use this procedure:

- Turn OFF the Device;
- Put Dip2 of 'Dip-Switch A' in ON position;
- Turn ON the device
- Connect the Ethernet cable;
- Insert the IP **"192.168.2.205"**;
- Press the **"Ping"** button, "Device Found! must appear";
- Press the **"Next"** button;
- Select which operations you want to do;
- Press the **"Execute update firmware"** button to start the upload;
- When all the operations are "OK" turn OFF the Device;
- Put Dip2 of 'Dip-Switch A' in OFF position;
- Turn ON the device.

If you know the actual IP address of the device, you have to use this procedure:

- Turn ON the Device with the Ethernet cable inserted;
- Insert the actual IP of the Converter;
- Press the **"Ping"** button, must appear "Device Found!";
- Press the **"Next"** button;
- Select which operations you want to do;
- Press the **"Execute update firmware"** button to start the upload;
- When all the operations are "OK" the device automatically goes at Normal Mode.

At this point the configuration/firmware on the device is correctly updated.

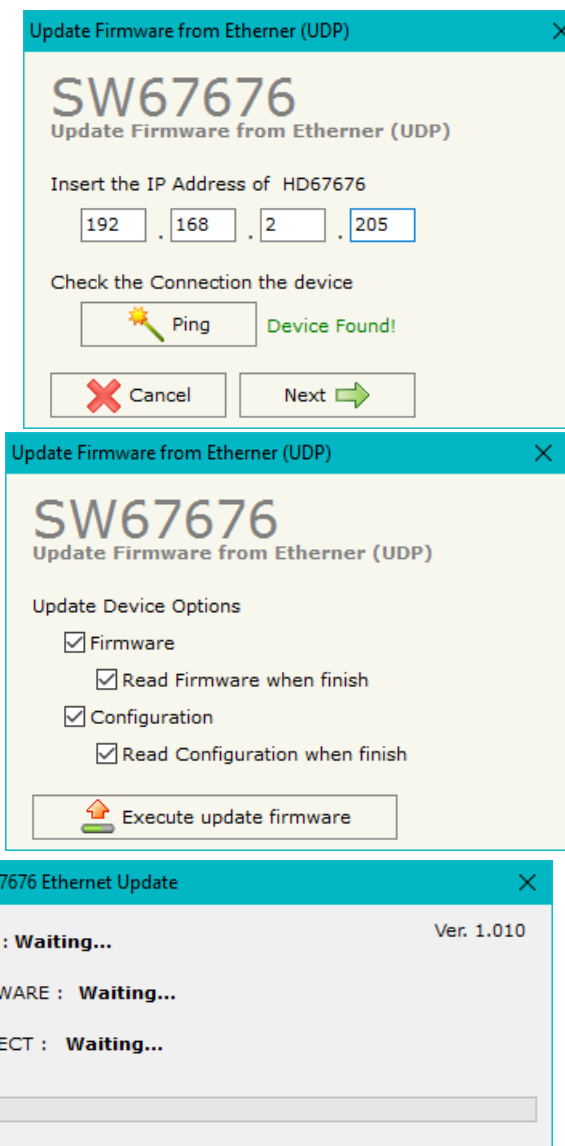

Figure 6: "Update via Ethernet" windows

**Note:**

When you install a new version of the software, if it is the first time it is better you do the update of the Firmware in the HD67676 device.

**Note:**

When you receive the device, for the first time, you also have to update the Firmware in the HD67676 device.

**Warning:**

If Fig. 7 appears when you try to do the Update try these points before seeking assistance:

- Try to repeat the operations for the updating;
- Try with another PC;
- Try to restart the PC;
- Check the LAN settings;
- If you are using the program inside a Virtual Machine, try to use in the main Operating System;
- If you are using Windows Seven, Vista, 8 and 10 make sure that you have the administrator privileges;
- In case you have to program more than one device, using the "UDP Update", you have to cancel the ARP table every time you connect a new device on Ethernet. For do this you have to launch the "Command Prompt" and write the command "arp -d". Pay attention that with Windows Vista, Seven, 8 you have to launch the "Command Prompt" with Administrator Rights;
- Pay attention at Firewall lock.

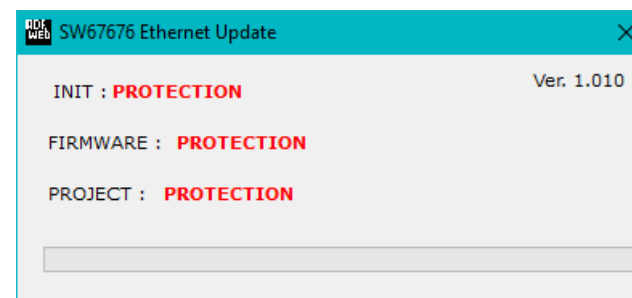
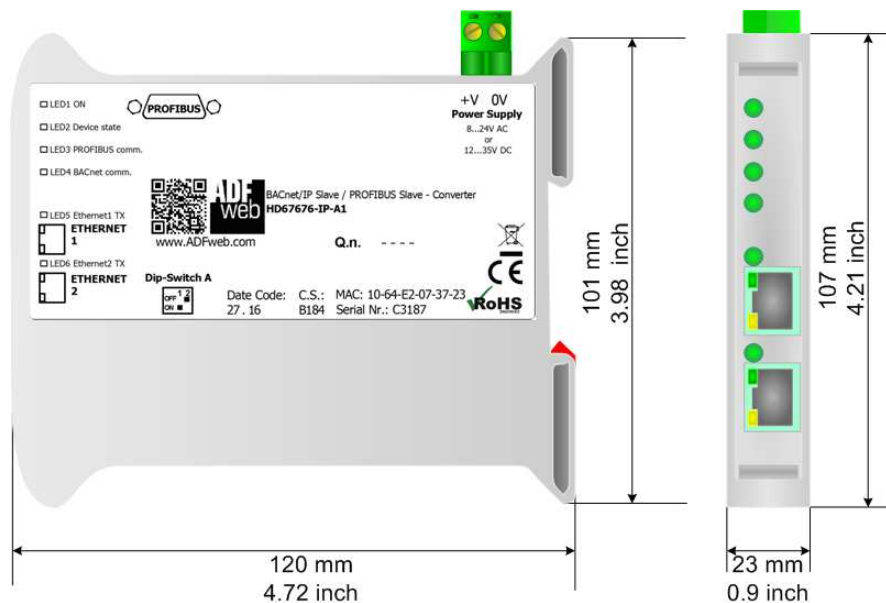

Figure 7: "Protection" window

In the case of HD67676 you have to use the software "SW67676": www.adfweb.com/download/filefold/SW67676.zip.

MECHANICAL DIMENSIONS:



Housing: PVC
Weight: 200g (Approx)

Figure 8a: Mechanical dimensions scheme for HD67676-IP-A1

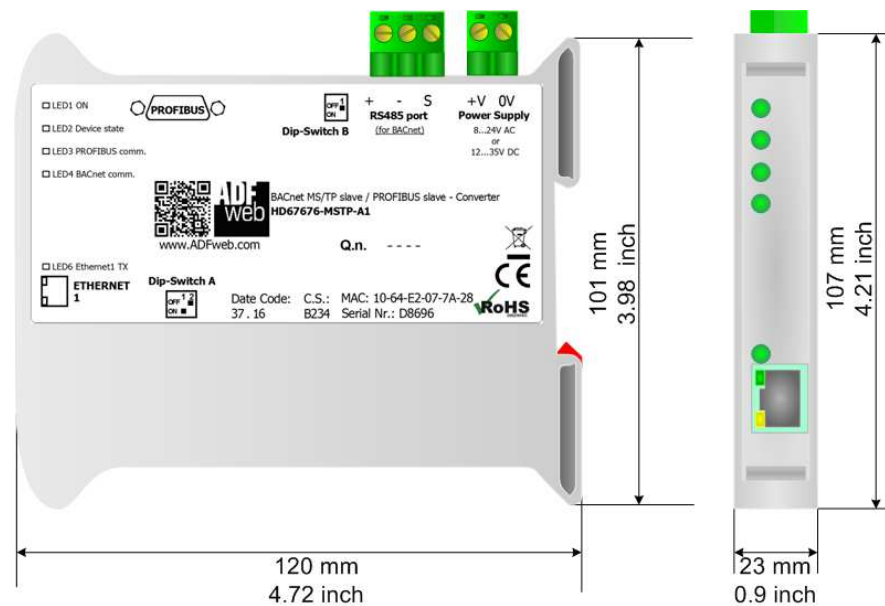

Housing: PVC
Weight: 200g (Approx)

Figure 8b: Mechanical dimensions scheme for HD67676-MSTP-A1

ORDERING INFORMATIONS:

The ordering part number is formed by a valid combination of the following:

HD67676 - x x x - A 1

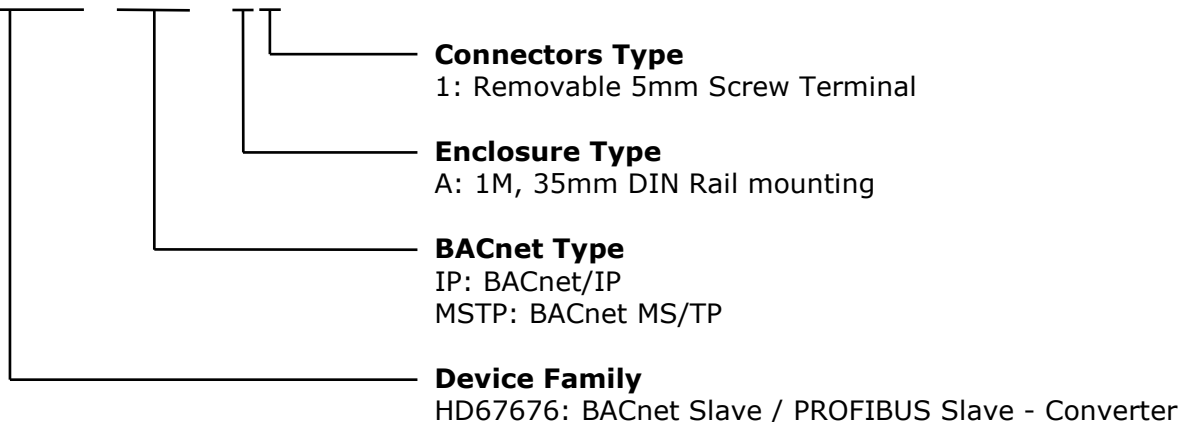

- Order Code: **HD67676-IP-A1** - BACnet/IP Slave / PROFIBUS Slave – Converter
- Order Code: **HD67676-MSTP-A1** - BACnet MS/TP Slave / PROFIBUS Slave - Converter

ACCESSORIES:

- Order Code: **AC34001** - 35mm Rail DIN - Power Supply 220/240V AC 50/60Hz – 12 V AC
- Order Code: **AC34002** - 35mm Rail DIN - Power Supply 110V AC 50/60Hz – 12 V AC

DISCLAIMER:

All technical content within this document can be modified without notice. The content of the document is a under continual renewal. For losses due to fire, earthquake, third party access or other accidents, or intentional or accidental abuse, misuse, or use under abnormal conditions repairs are charged to the user. ADFweb.com S.r.l. will not be liable for accidental loss of use or inability to use this product, such as loss of business income. ADFweb.com S.r.l. shall not be liable for consequences of improper use.

OTHER REGULATIONS AND STANDARDS:**WEEE INFORMATION**

Disposal of old electrical and electronic equipment (as in the European Union and other European countries with separate collection systems).

— This symbol on the product or on its packaging indicates that this product may not be treated as household rubbish. Instead, it should be taken to an applicable collection point for the recycling of electrical and electronic equipment. If the product is disposed correctly, you will help prevent potential negative environmental factors and impact of human health, which could otherwise be caused by inappropriate disposal. The recycling of materials will help to conserve natural resources. For more information about recycling this product, please contact your local city office, your household waste disposal service or the shop where you purchased the product.

RESTRICTION OF HAZARDOUS SUBSTANCES DIRECTIVE

The device respects the 2002/95/EC Directive on the restriction of the use of certain hazardous substances in electrical and electronic equipment (commonly referred to as Restriction of Hazardous Substances Directive or RoHS).

CE MARKING

The product conforms with the essential requirements of the applicable EC directives.

WARRANTIES AND TECHNICAL SUPPORT:

For fast and easy technical support for your ADFweb.com SRL products, consult our internet support at www.adfweb.com.
Otherwise contact us at the address support@adfweb.com

RETURN POLICY:

If while using your product you have any problem and you wish to exchange or repair it, please do the following:

- Obtain a Product Return Number (PRN) from our internet support at www.adfweb.com. Together with the request, you need to provide detailed information about the problem.
- Send the product to the address provided with the PRN, having prepaid the shipping costs (shipment costs billed to us will not be accepted).

If the product is within the warranty of twelve months, it will be repaired or exchanged and returned within three weeks. If the product is no longer under warranty, you will receive a repair estimate.



ADFweb.com S.r.l.
Via Strada Nuova, 17
IT-31010 Mareno di Piave
TREVISO (Italy)
Phone +39.0438.30.91.31
Fax +39.0438.49.20.99
www.adfweb.com

