

User Manual

Revision 1.000
English

BACnet Slave / S7comm - Converter

(Order Code: HD67630-IP-A1, HD67630-MSTP-A1, HD67630-MSTP-B2)

for Website information:

<http://www.adfweb.com/?Product=HD67630>

for Price information:

<http://www.adfweb.com/?Price=HD67630-IP-A1>

<http://www.adfweb.com/?Price=HD67630-MSTP-A1>

<http://www.adfweb.com/?Price=HD67630-MSTP-B2>

Benefits and Main Features:

- ✦ Triple electrical isolation
- ✦ Two Ethernet ports
- ✦ Temperature range: -40°C/+85°C (-40°F/+185°F)



For others S7comm devices, see also the following links:

S7comm from/to ...

- www.adfweb.com?Product=HD67618
- www.adfweb.com?Product=HD67619
- www.adfweb.com?Product=HD67620
- www.adfweb.com?Product=HD67621
- www.adfweb.com?Product=HD67622
- www.adfweb.com?Product=HD67623
- www.adfweb.com?Product=HD67624
- www.adfweb.com?Product=HD67625
- www.adfweb.com?Product=HD67626
- www.adfweb.com?Product=HD67627
- www.adfweb.com?Product=HD67628
- www.adfweb.com?Product=HD67629
- www.adfweb.com?Product=HD67631
- www.adfweb.com?Product=HD67632
- www.adfweb.com?Product=HD67633
- www.adfweb.com?Product=HD67D39
- www.adfweb.com?Product=HD67E28

- (Modbus TCP Slave)
- (PROFIBUS Slave)
- (IEC61850 Server)
- (Serial)
- (Modbus Slave)
- (CAN)
- (CANopen)
- (DeviceNet Slave)
- (SNMP Agent)
- (EtherNet/IP Slave)
- (KNX)
- (MQTT)
- (Ethernet)
- (OPC UA Server)
- (PROFINET Slave)
- (LoRaWAN)
- (EtherCAT Slave)

Do you have an your customer protocol?

See the following links:

www.adfweb.com?Product=HD67003

Do you need to choose a device? do you want help?

Ask it to the following link:

www.adfweb.com?Cmd=helpme



User Manual

INDEX:

	Page
INDEX	2
UPDATED DOCUMENTATION	2
REVISION LIST	2
WARNING	2
TRADEMARKS	2
SECURITY ALERT	3
EXAMPLE OF CONNECTION	4
CONNECTION SCHEME	5
CHARACTERISTICS	8
CONFIGURATION	8
POWER SUPPLY	9
FUNCTION MODES	10
LEDS (for HD67630-IP-A1)	11
LEDS (for HD67630-MSTP-XX)	12
ETHERNET	13
RS485 (for BACnet MS/TP)	14
USE OF COMPOSITOR SW67630	15
NEW PROJECT / OPEN PROJECT	16
SOFTWARE OPTIONS	17
SET COMMUNICATION	19
S7COMM ACCESS	21
SET BACNET ACCESS	24
BACNET EDE FILE	25
UPDATE DEVICE	26
MECHANICAL DIMENSIONS	28
ORDERING INFORMATIONS	31
ACCESSORIES	31
DISCLAIMER	32
OTHER REGULATIONS AND STANDARDS	32
WARRANTIES AND TECHNICAL SUPPORT	33
RETURN POLICY	33

UPDATED DOCUMENTATION:

Dear customer, we thank you for your attention and we remind you that you need to check that the following document is:

- ✚ Updated
- ✚ Related to the product you own

To obtain the most recently updated document, note the “document code” that appears at the top right-hand corner of each page of this document.

With this “Document Code” go to web page www.adfweb.com/download/ and search for the corresponding code on the page. Click on the proper “Document Code” and download the updates.

REVISION LIST:

Revision	Date	Author	Chapter	Description
1.000	13/03/2020	Ff	All	First release version

WARNING:

ADFweb.com reserves the right to change information in this manual about our product without warning.

ADFweb.com is not responsible for any error this manual may contain.

TRADEMARKS:

All trademarks mentioned in this document belong to their respective owners.

SECURITY ALERT:**GENERAL INFORMATION**

To ensure safe operation, the device must be operated according to the instructions in the manual. When using the device, legal and safety regulation are required for each individual application. The same applies also when using accessories.

INTENDED USE

Machines and systems must be designed so the faulty conditions do not lead to a dangerous situation for the operator (i.e. independent limit switches, mechanical interlocks, etc.).

QUALIFIED PERSONNEL

The device can be used only by qualified personnel, strictly in accordance with the specifications.

Qualified personnel are persons who are familiar with the installation, assembly, commissioning and operation of this equipment and who have appropriate qualifications for their job.

RESIDUAL RISKS

The device is state-of-the-art and is safe. The instruments can represent a potential hazard if they are inappropriately installed and operated by untrained personnel. These instructions refer to residual risks with the following symbol:



This symbol indicates that non-observance of the safety instructions is a danger for people that could lead to serious injury or death and / or the possibility of damage.

CE CONFORMITY

The declaration is made by our company. You can send an email to support@adfweb.com or give us a call if you need it.

EXAMPLE OF CONNECTION:

BACnet / S7comm - Converter
HD67630-xxxx-A1

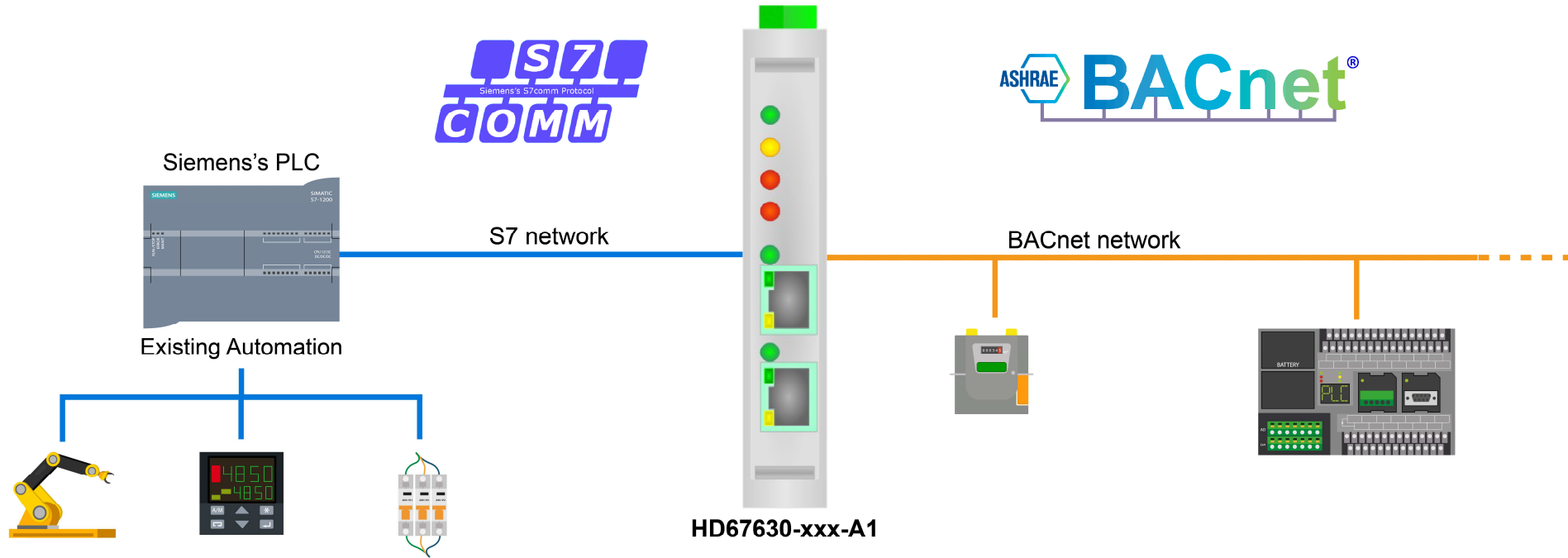

ADFweb.com



+39 0438 309 131



+39 349 440 9592



support@adfweb.com

CONNECTION SCHEME:

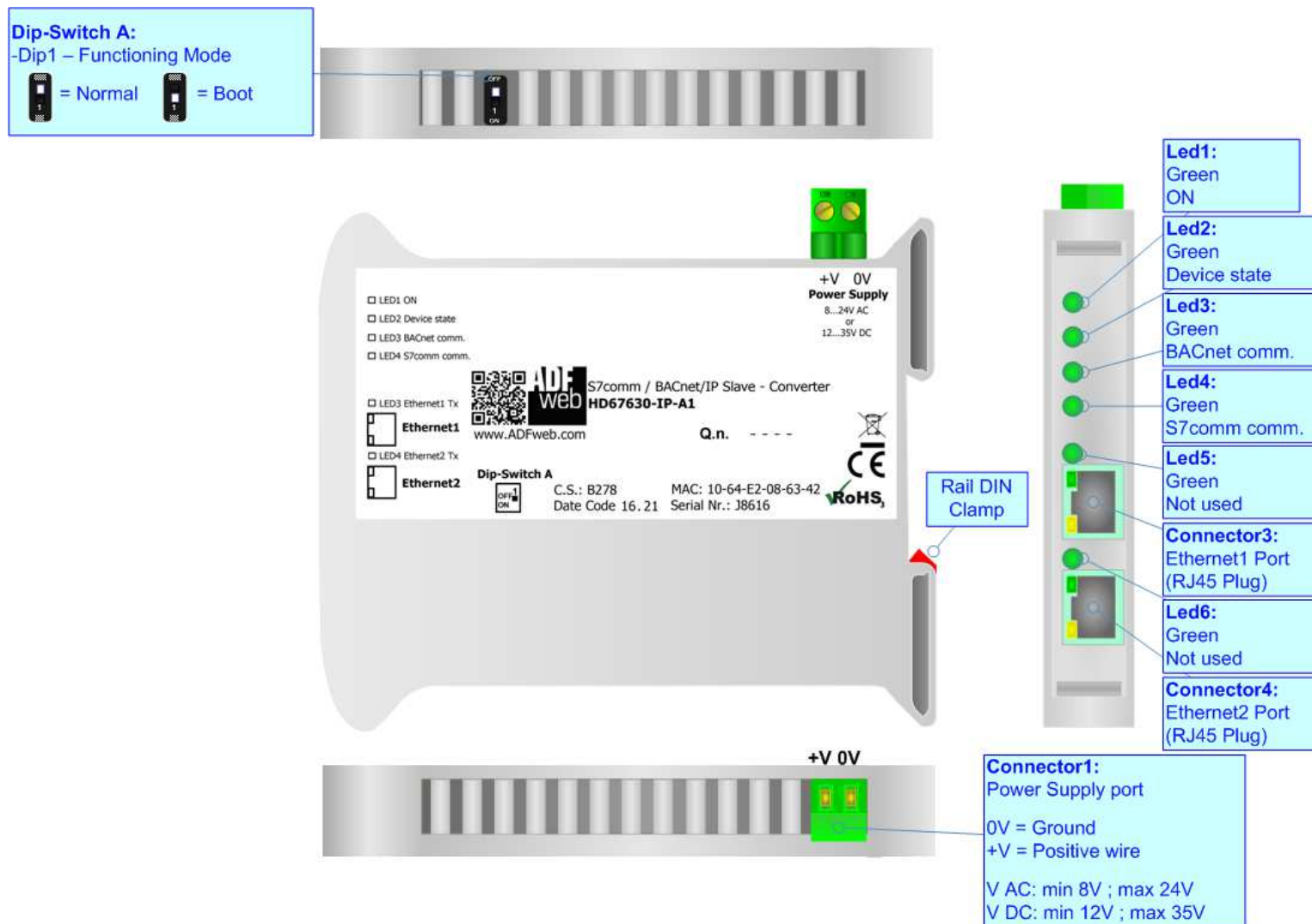

Figure 1a: Connection scheme for HD67630-IP-A1

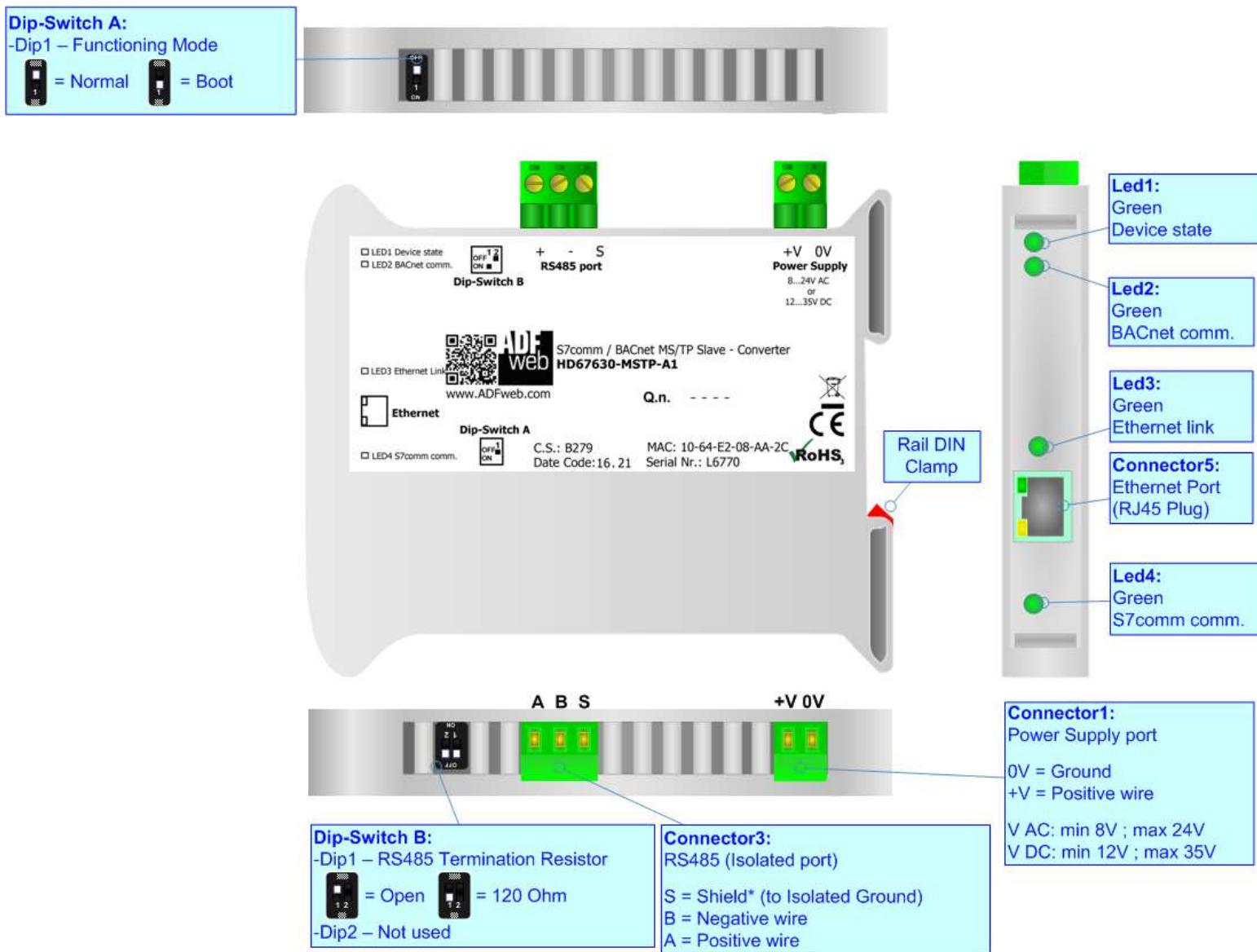

Figure 1b: Connection scheme for HD67630-MSTP-A1

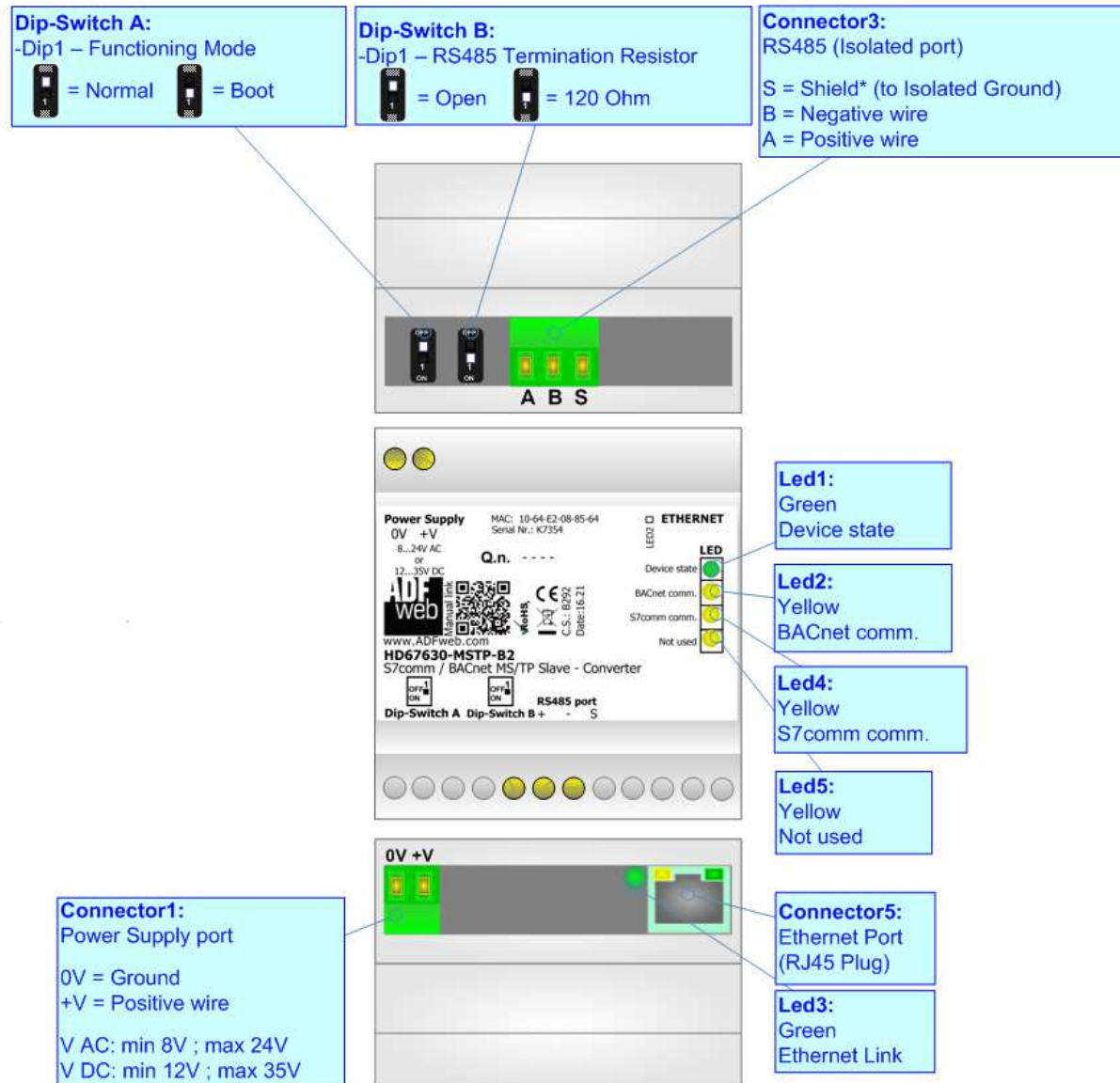

Figure 1c: Connection scheme for HD67630-MSTP-B2

CHARACTERISTICS:

The HD67630 is a BACnet Slave / S7comm Converter.

It allows the following characteristics:

- Two-directional information between S7comm and BACnet;
- Mountable on 35mm Rail DIN;
- Wide power supply input range: 8...24V AC or 12...35V DC;
- Wide temperature range: -40°C / 85°C [-40°F / +185°F].

CONFIGURATION:

You need Compositor SW67630 software on your PC in order to perform the following:

- Define the parameter of the BACnet;
- Define the parameter of the S7comm;
- Define the S7comm requests to send to the S7comm servers;
- Define the BACnet objects accessible by the external Master;
- Update the device.

POWER SUPPLY:

The devices can be powered between a wide range of tensions. For more details see the two tables below.

	VAC		VDC	
	Vmin	Vmax	Vmin	Vmax
HD67630-xxxx-xx	8V	24V	12V	35V

Consumption at 24V DC:

Device	W/VA
HD67630-xxxx-xx	4



Caution: Not reverse the polarity power

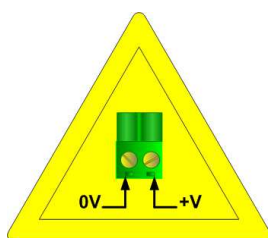

HD67630-IP-A1
HD67630-MSTP-A1

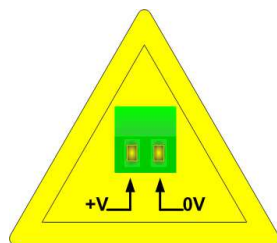

HD67630-MSTP-B2

Connector1:
Power Supply port
0V = Ground
+V = Positive wire
V AC: min 8V ; max 24V
V DC: min 12V ; max 35V

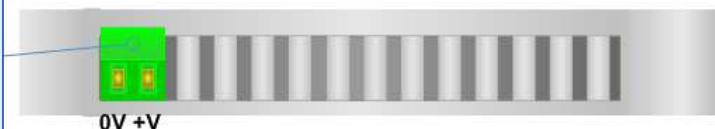

Connector1:
Power Supply port
0V = Ground
+V = Positive wire
V AC: min 8V ; max 24V
V DC: min 12V ; max 35V

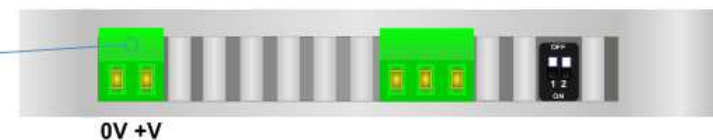

Connector1:
Power Supply port
0V = Ground
+V = Positive wire
V AC: min 8V ; max 24V
V DC: min 12V ; max 35V

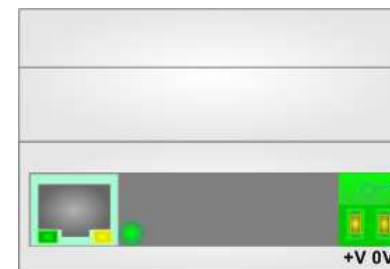

FUNCTION MODES:

The device has got two functions mode depending of the position of the Dip1 of 'Dip-Switch A':

- The first, with Dip1 in Off position (factory setting), is used for the normal working of the device.
- The second, with Dip1 in On position, is used for upload the Project/Firmware.

For the operations to follow for the updating (see 'UPDATE DEVICE' section).

According to the functioning mode, the LEDs will have specifics functions (see 'LEDS' section).

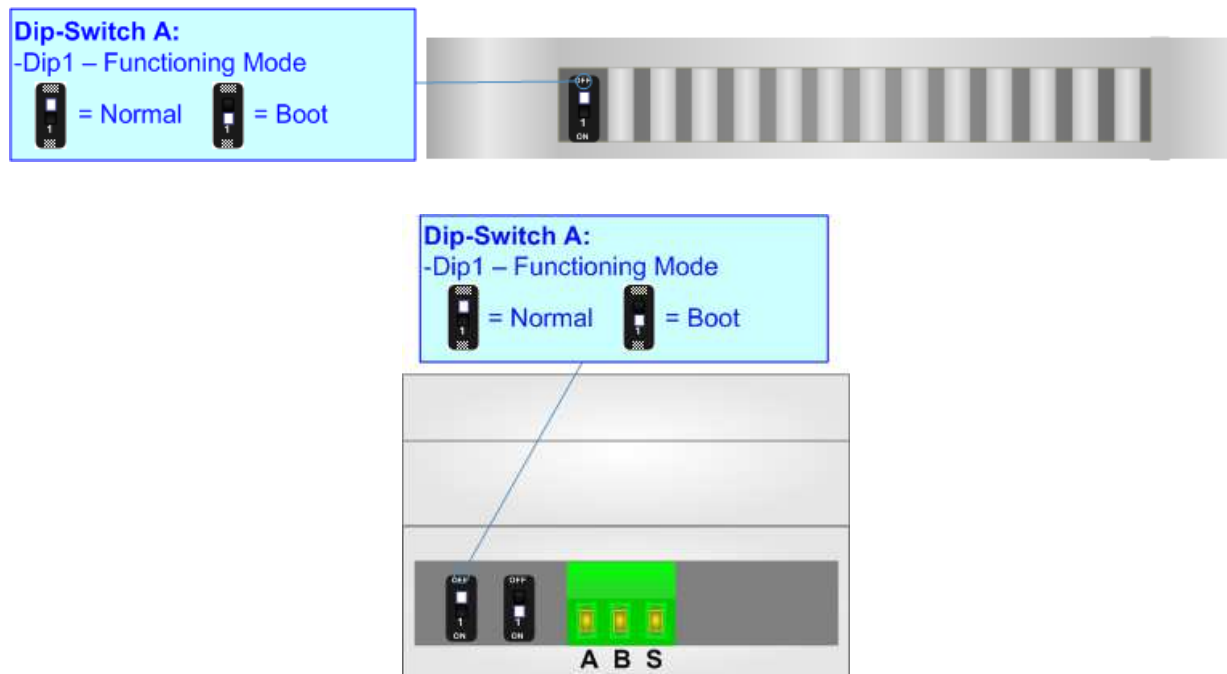

LEDS (for HD67630-IP-A1):

The device has got six LEDs that are used to give information of the functioning status. The various meanings of the LEDs are described in the table below.

LED	Normal Mode	Boot Mode
1: ON [supply voltage] (green)	ON: Device powered OFF: Device not powered	ON: Device powered OFF: Device not powered
2: Device State (green)	Blinks slowly (~1Hz)	Blinks quickly: Boot state Blinks very slowly (~0.5Hz): update in progress
3: BACnet communication (green)	Blinks when a BACnet request is received	Blinks quickly: Boot state Blinks very slowly (~0.5Hz): update in progress
4: S7comm communication (green)	Blinks when a S7comm response is received	Blinks quickly: Boot state Blinks very slowly (~0.5Hz): update in progress
5: Not used (green)	OFF	Blinks quickly: Boot state Blinks very slowly (~0.5Hz): update in progress
6: Not used (green)	OFF	Blinks quickly: Boot state Blinks very slowly (~0.5Hz): update in progress

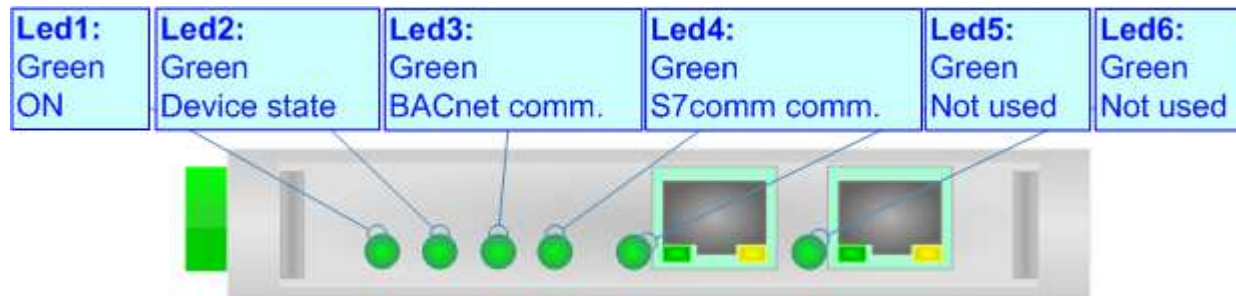

LEDS (for HD67630-MSTP-XX):

The device has five LEDs that are used to give information of the functioning status. The various meanings of the LEDs are described in the table below.

LED	Normal Mode	Boot Mode
1: Device State (green)	Blinks slowly (~1Hz)	Blinks quickly: Boot state Blinks very slowly (~0.5Hz): update in progress
2: BACnet comm. (green)	Blinks when a BACnet request is received	Blinks quickly: Boot state Blinks very slowly (~0.5Hz): update in progress
3: Link Ethernet (green)	ON: Ethernet cable connected OFF: Ethernet cable disconnected	ON: Ethernet cable connected OFF: Ethernet cable disconnected
4: S7comm comm. (yellow)	Blinks quickly when a S7comm response is received	Blinks quickly: Boot state Blinks very slowly (~0.5Hz): update in progress
5: Not used (yellow) (only for HD67630-MSTP-B2)	OFF	Blinks quickly: Boot state Blinks very slowly (~0.5Hz): update in progress

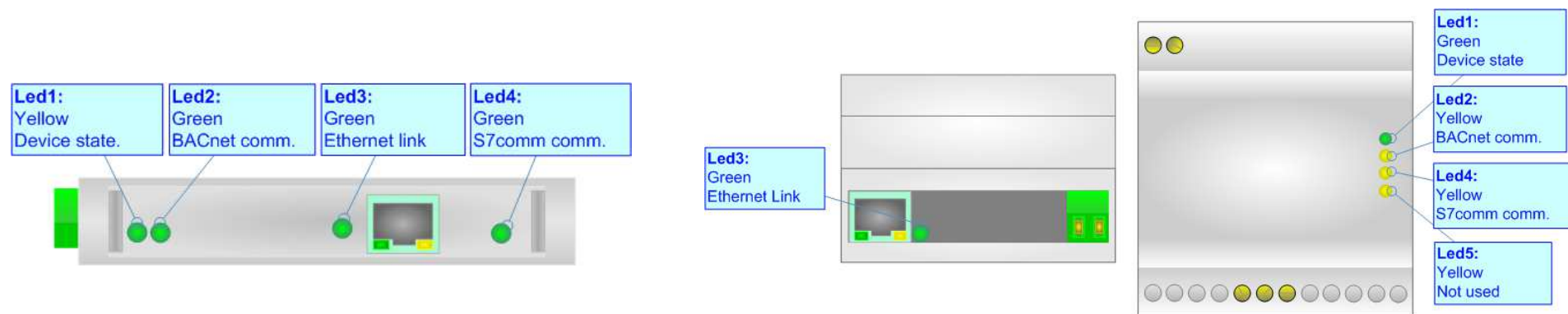

ETHERNET:

The Ethernet connection must be made using Connector3/Connector4/Connector5 of HD67630-xxxx-xx with at least a Category 5E cable. The maximum length of the cable should not exceed 100m. The cable has to conform to the T568 norms relative to connections in cat.5 up to 100 Mbps. To connect the device to an Hub/Switch is recommended the use of a straight cable, to connect the device to a PC/PLC/other is recommended the use of a cross cable.

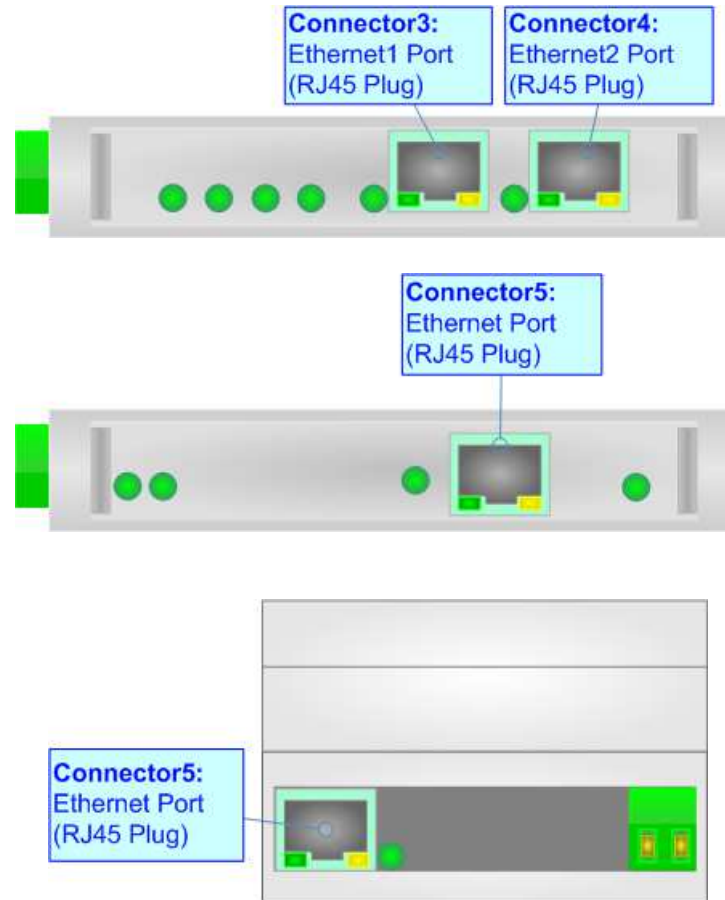

RS485 (for BACnet MS/TP):

To terminate the RS485 line with a 120Ω resistor it is necessary to put ON dip 1, like in figure.

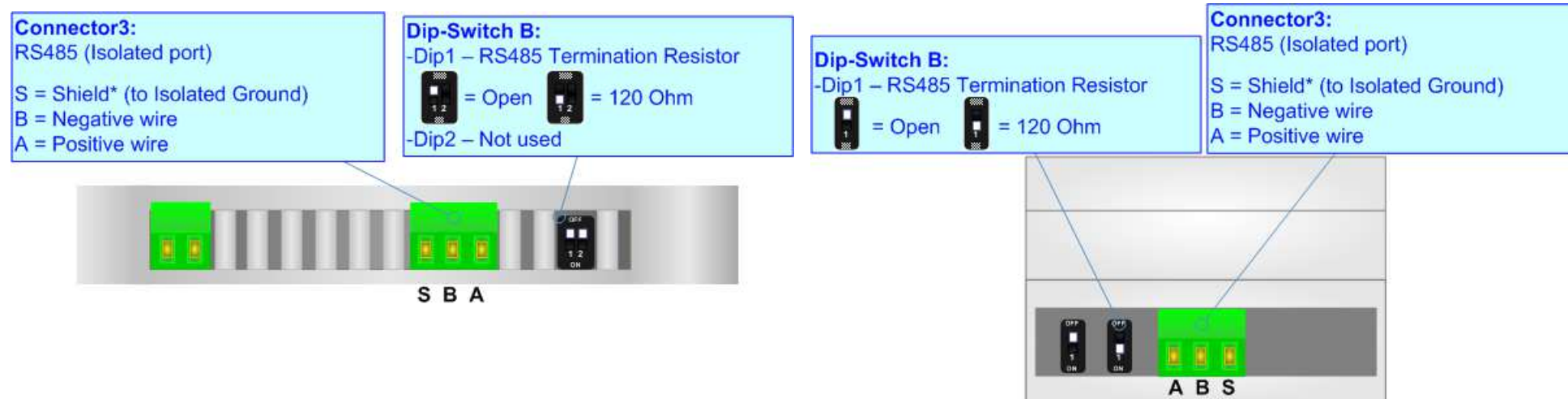

The maximum length of the cable should be 1200m (4000 feet).

Here some codes of cables:

- Belden: p/n 8132 - 2x 28AWG stranded twisted pairs conductor + foil shield + braid shield;
- Belden: p/n 82842 - 2x 24AWG stranded twisted pairs conductor + foil shield + braid shield;
- Tasker: p/n C521 - 1x 24AWG twisted pair conductor + foil shield + braid shield;
- Tasker: p/n C522 - 2x 24AWG twisted pairs conductor + foil

USE OF COMPOSITOR SW67630:

To configure the Converter, use the available software that runs with Windows called SW67630. It is downloadable on the site www.adfweb.com and its operation is described in this document. *(This manual is referenced to the last version of the software present on our web site).* The software works with MSWindows (XP, Vista, Seven, 8, 10; 32/64bit).

When launching the SW67630, the window below appears (Fig. 2).

 **Note:**
It is necessary to have installed .Net Framework 4.

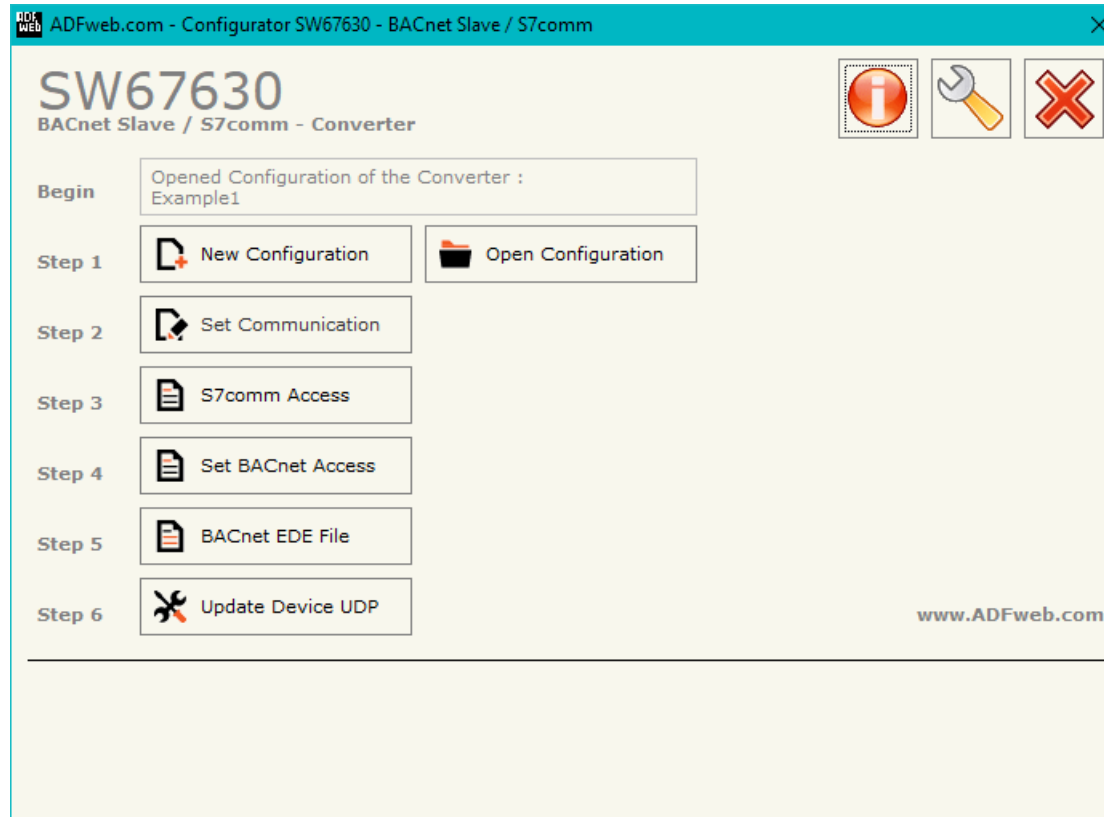
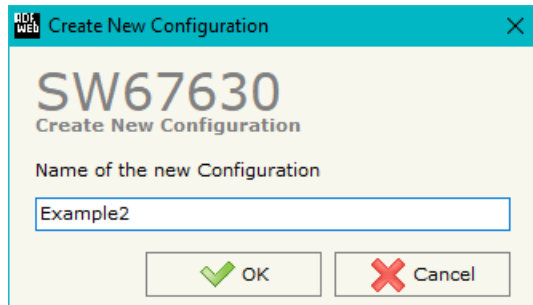

Figure 2: Main window for SW67630

NEW CONFIGURATION / OPEN CONFIGURATION:

The “**New Configuration**” button creates the folder which contains the entire device’s configuration.



A device’s configuration can also be imported or exported:

- To clone the configurations of a programmable “BACnet Slave / S7comm - Converter” in order to configure another device in the same manner, it is necessary to maintain the folder and all its contents;
- To clone a project in order to obtain a different version of the project, it is sufficient to duplicate the project folder with another name and open the new folder with the button “**Open Configuration**”.

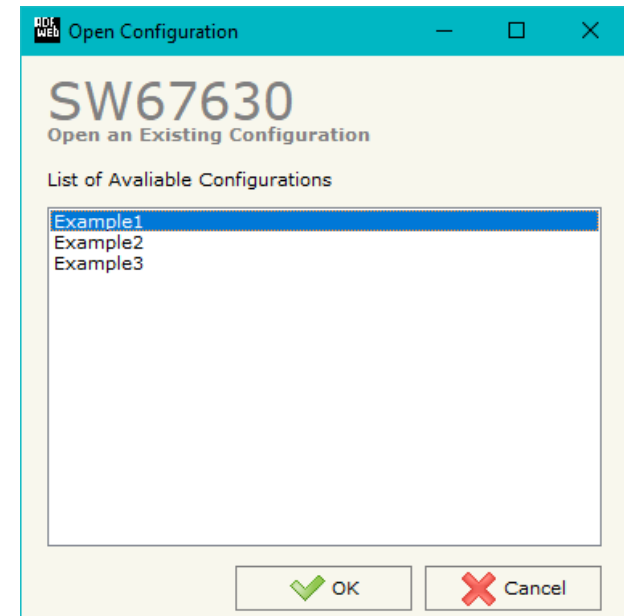

SOFTWARE OPTIONS:

By pressing the “**Settings**” () button there is the possibility to change the language of the software and check the updatings for the compositor.

In the section “Language” it is possible to change the language of the software.

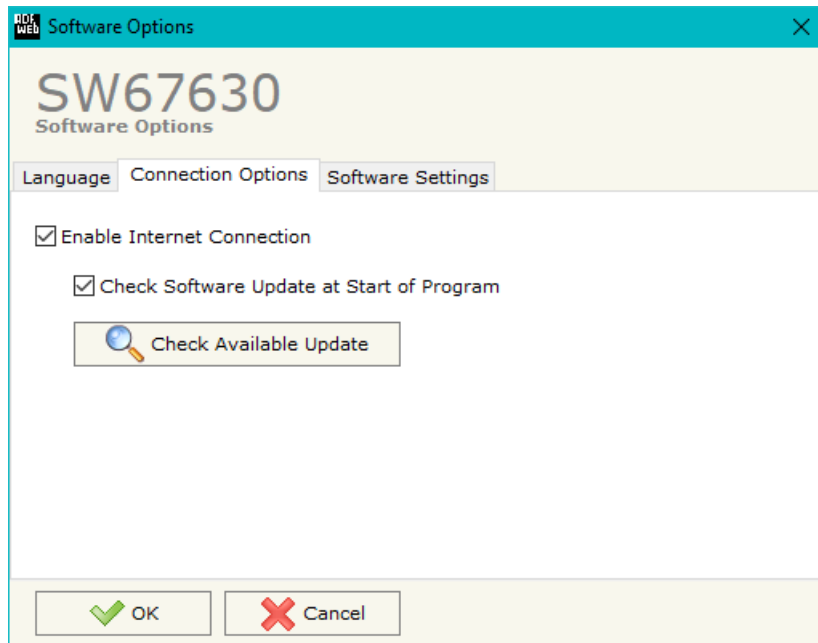

In the section “Connection Options”, it is possible to check if there are some updatings of the software compositor in ADFweb.com website. Checking the option “**Check Software Update at Start of Program**”, the SW67630 check automatically if there are updatings when it is launched.

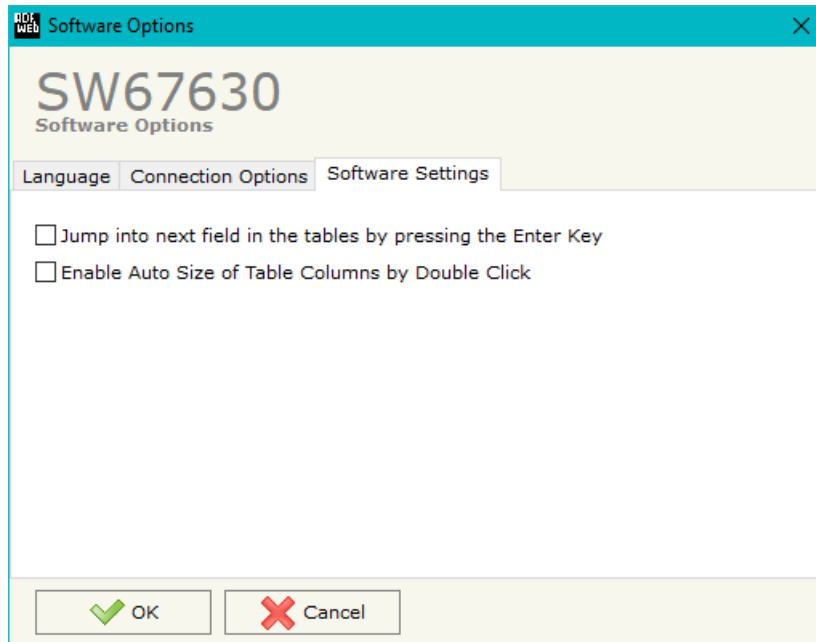

In the section "Software Settings", it is possible to enable/disable some keyboard's commands for an easier navigation inside the tables contained in the different sections of the software.

SET COMMUNICATION:

This section define the fundamental communication parameters of two buses, BACnet and S7comm.

By Pressing the **"Set Communication"** button from the main window for SW67632 (Fig. 2) the window "Set Communication" appears (Fig. 3).

The means of the fields for "S7comm" are:

- In the fields **"IP ADDRESS"** the IP address for S7comm side of the converter is defined;
- In the fields **"SUBNET Mask"** the SubNet Mask for S7comm side of the converter is defined;
- In the fields **"GATEWAY"** the default gateway of the net is defined. This feature can be enabled or disabled pressing the Check Box field. This feature is used for going out of the net.

In the field "BACnet Type" is possible to select the type of BACnet to use from:

- BACnet/IP (over Ethernet);
- BACnet MS/TP (over RS485).

If selected "BACnet/IP", the means of the fields for "BACnet" are:

- In the fields **"IP ADDRESS"** the IP address of the converter is defined;
- In the fields **"SUBNET Mask"** the SubNet Mask of the converter is defined;
- In the fields **"GATEWAY"** the default gateway of the network is defined. This feature can be enabled or disabled pressing the Check Box field. This feature is used for going out of the net;
- In the field **"Port"** the port used for BACnet communication is defined. The default port used for BACnet communication is 47808, but it is possible to insert any value (except 10000 and 10001);
- In the field **"BACnet Device Name"** the name of BACnet/IP side of the converter is defined;
- In the field **"Device Identifier"** the ID of BACnet/IP side of the converter is defined;

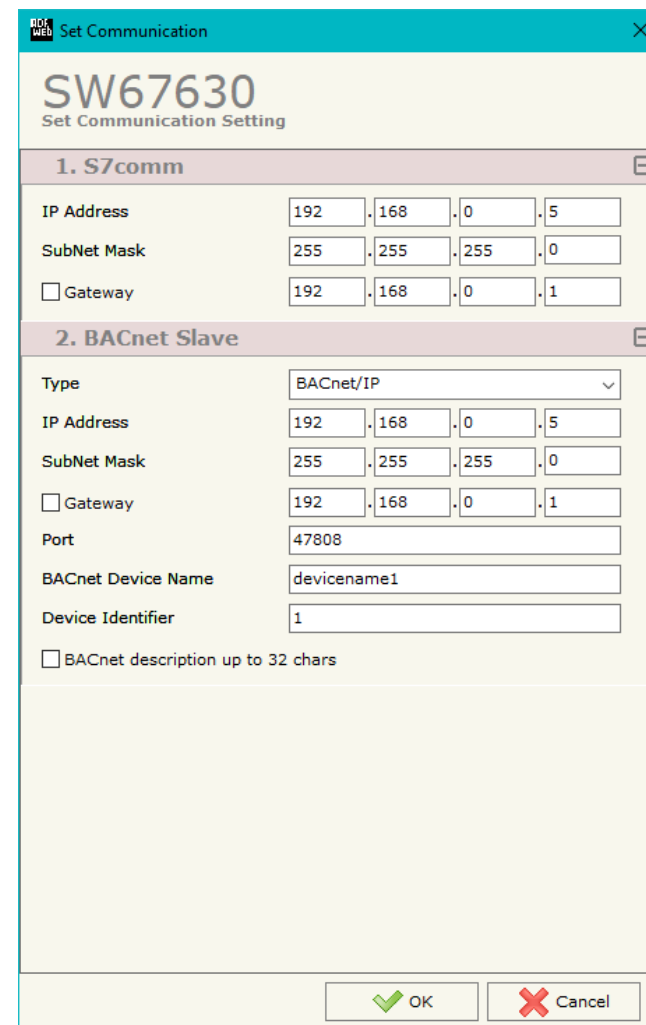

Figure 3a. "Set Communication" window

- If the field "**BACnet description up to 32 chars**" is checked, the description for the BACnet Objects can be up to 32 chars long;

If selected "BACnet MS/TP", the means of the fields for "BACnet" are:

- In the field "**Baudrate**" the data rate of the BACnet line is defined;
- In the field "**Parity**" the parity of the line is defined;
- In the field "**BACnet Device Name**" the name to give to the BACnet node is defined;
- In the field "**MAC Address**" the MAC of BACnet node (from 0 to 254) is defined;
- The field "**Max Master**" specifies the highest allowable address for master nodes. The value shall be less than or equal to 127;
- The field "**Max Info Frames**" specifies the maximum number of information frames the node may send before it must pass the token;
- In the field "**Device Instance**" the of the BACnet MS/TP side of the converter is defined;
- In the field "**Network**" the BACnet MS/TP network number is defined;
- If the field "**BACnet description up to 32 chars**" is checked, the description for the BACnet Objects can be up to 32 chars long.

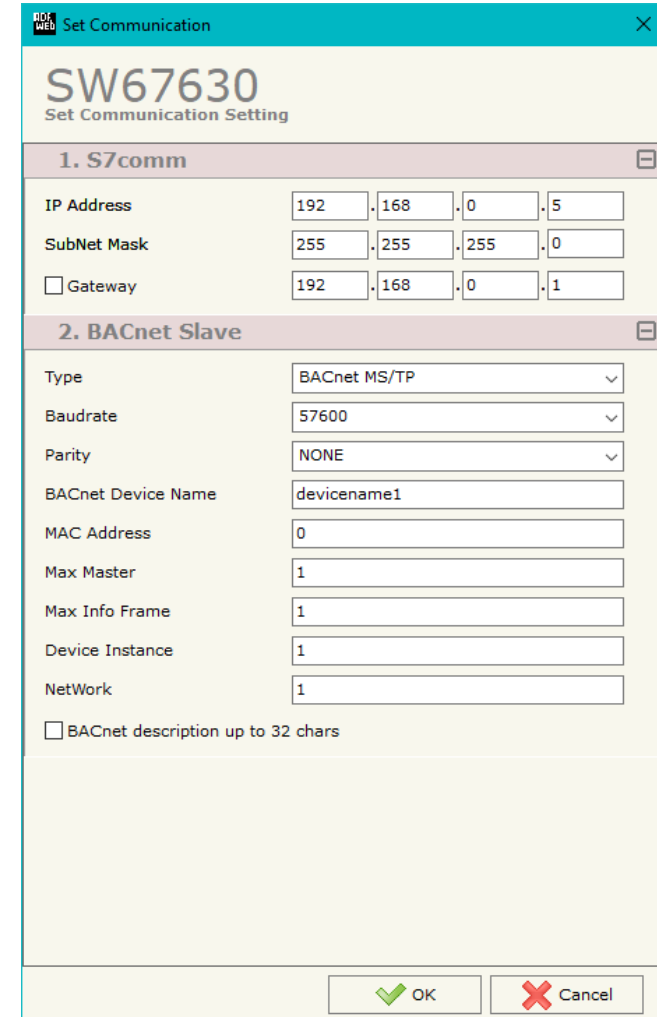

Figure 3b: "Set Communication" window

S7COMM ACCESS:

By Pressing the "**S7comm Access**" button from the main window of SW67630 (Fig. 2), the window "Set S7comm Access" appears (Fig. 4). The window is divided in two parts, the "**S7comm Read**" that contains the data that the converter reads from the S7comm servers and "**S7comm Write**" that contains the data that the converter writes into the S7comm servers.

N	Enable	PLC Address	PLC Port	PLC Type	Rack	Slot	Data Type	Data Identifier	DB Number	PLC Area	PLC Add	PLC Bit	Poll Time	Position	Start Bit	Swap	Swap Word	Mnemonic
1	<input checked="" type="checkbox"/>	192.168.2.60	1001	S71200	0	0	Word	OB	0	Direct peripheral	0	0	1000	0	0	<input type="checkbox"/>	<input type="checkbox"/>	
2	<input checked="" type="checkbox"/>															<input type="checkbox"/>	<input type="checkbox"/>	
3	<input checked="" type="checkbox"/>															<input type="checkbox"/>	<input type="checkbox"/>	
4	<input checked="" type="checkbox"/>															<input type="checkbox"/>	<input type="checkbox"/>	
5	<input checked="" type="checkbox"/>															<input type="checkbox"/>	<input type="checkbox"/>	

Figure 4a: "S7comm Access → S7comm Read" window

The means of the fields in the window "S7comm Read" are the following:

- In the field "**PLC Address**" the IP address of the PLC that contains the data to be read is defined;
- In the field "**PLC Port**" the port used for S7comm communication is defined;
- In the field "**PLC Type**" the family of the PLC is defined;
- In the field "**Rack**" the Rack's ID of the PLC is defined;
- In the field "**Slot**" the Slot's ID is defined;
- In the field "**Data Type**" the data format of the variable to read is defined;
- In the field "**Data Identifier**" the identifier of the variable to read is defined;
- In the field "**PLC Area**" the memory area where the data is located inside the PLC is defined;
- In the field "**PLC Add**" the starting memory address where the data is located is defined;
- In the field "**PLC Bit**" the starting bit of the selected PLC Address is defined;
- In the field "**Poll Time**" the frequency of the request is defined (in ms);
- In the field "**Position**" the starting byte of the internal memory array from which mapping the data read is defined;

- In the field "**Start Bit**" is used for the "Bit" data. It is possible to select the bit of the selected Position where mapping the data;
- If the field "**Swap**" is checked, the bytes' order is reversed;
- If the field "**Swap Word**" is checked, the words' order is reversed;
- In the field "**Mnemonic**" a description of the data inserted in the row is defined.

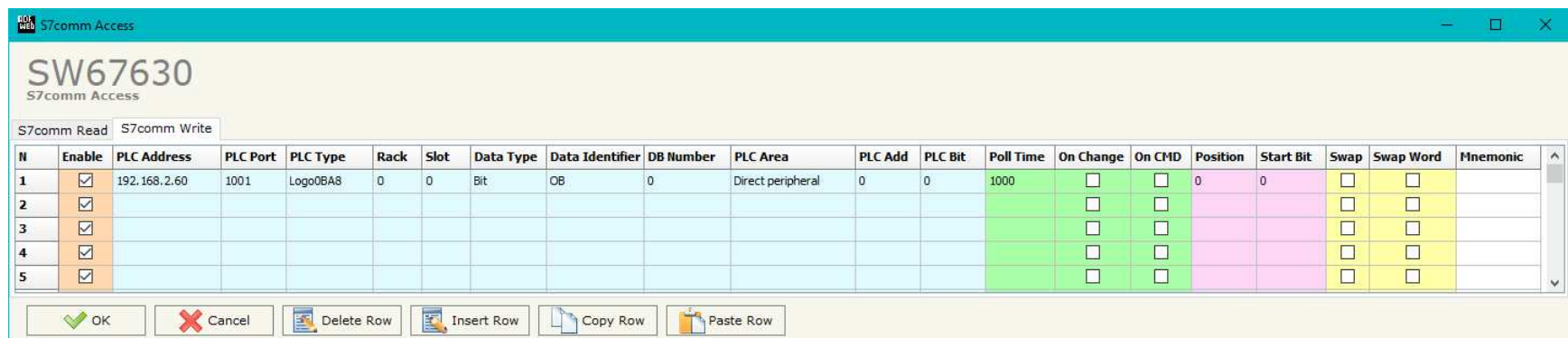

Figure 4b: "S7comm Access → S7comm Write" window

The means of the fields in the window "S7comm Read" are the following:

- In the field "**PLC Address**" the IP address of the PLC that contains the data to be read is defined;
- In the field "**PLC Port**" the port used for S7comm communication is defined;
- In the field "**PLC Type**" the family of the PLC is defined;
- In the field "**Rack**" the Rack's ID of the PLC is defined;
- In the field "**Slot**" the Slot's ID is defined;
- In the field "**Data Type**" the data format of the variable to read is defined;
- In the field "**Data Identifier**" the identifier of the variable to read is defined;
- In the field "**PLC Area**" the memory area where the data is located inside the PLC is defined;
- In the field "**PLC Add**" the starting memory address where the data is located is defined;
- In the field "**PLC Bit**" the starting bit of the selected PLC Address is defined;
- In the field "**Poll Time**" the frequency of the request is defined (in ms);
- By checking the field "**On Change**" the S7comm write request is sent only if BACnet data are changed;
- By checking the field "**On CMD**" the S7comm write request is sent when a BACnet writing for the selected variable is received;
- In the field "**Position**" the starting byte of the internal memory array from which taking the data to write is defined;
- The field "**Start Bit**" is used for the "Bit" data. It is possible to select the bit of the selected Position from which taking the data;
- If the field "**Swap**" is checked, the bytes' order is reversed;
- If the field "**Swap W**" is checked, the words' order is reversed;
- In the field "**Mnemonic**" a description of the data inserted in the row is defined.

SET BACNET ACCESS:

By Pressing the “**Set BACnet Access**” button from the main window for SW67630 (Fig. 2) the window “BACnet Set Access” appears (Fig. 5).

The window is divided in two parts, the “**BACnet in Read**” that contains the BACnet objects readable by a BACnet Master; and “**BACnet in Write**” that contains the BACnet objects writeable by a BACnet Master.

The meaning of the fields in the window are the follows:

- In the field “**Data Type**” is possible to select the BACnet object data type;
- In the field “**Eng. Unit**”, with double click the window “*Select the BACnet Engineering Unit*” appears (Fig. 6);
- In the field “**Position**” is possible to select the position where take/save the data from a 6000 bytes array;
- The field “**Start Bit**” is used for the “Binary In” and “Binary Out” BACnet objects;
- The field “**Length**” is used for all the others BACnet objects;
- In the field “**Mnemonic**” a description of the object is defined.

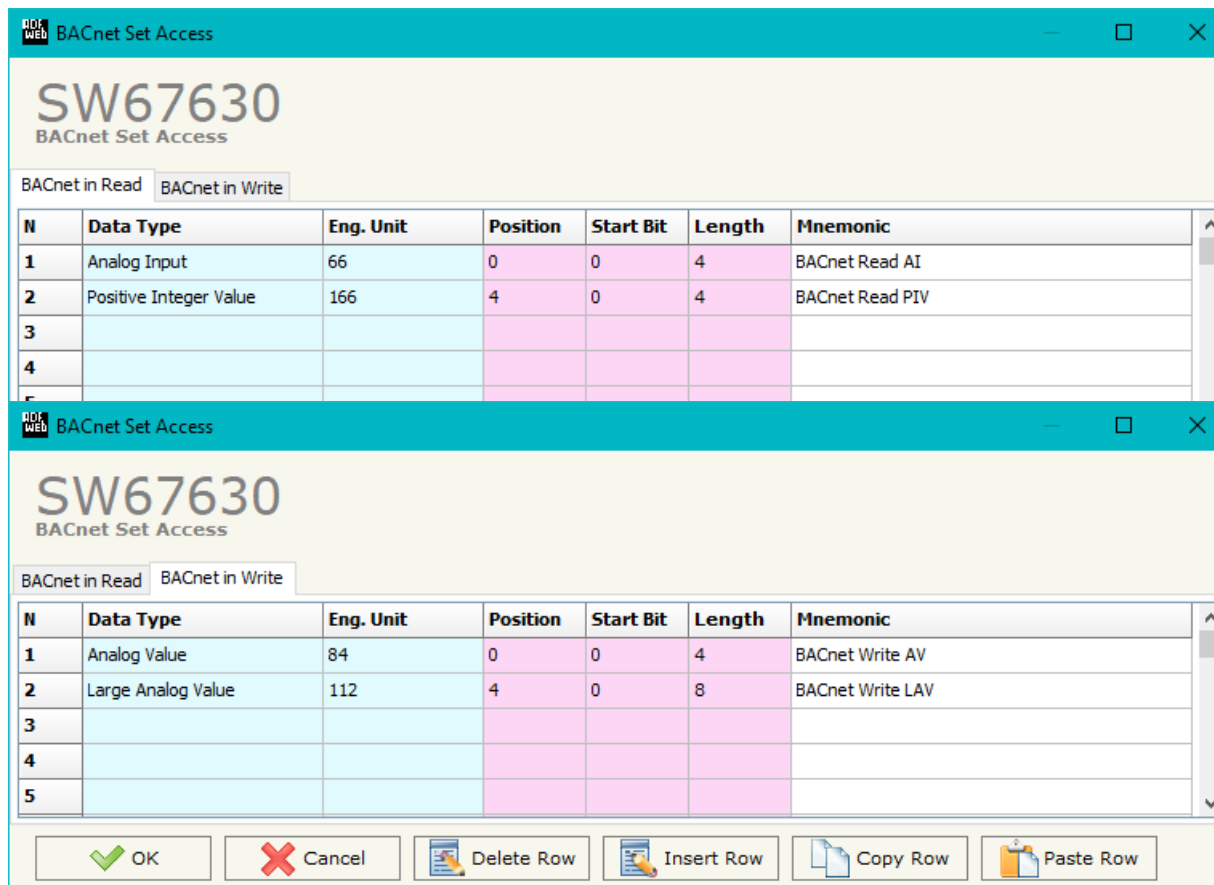

Figure 5: “BACnet Set Access” window

Is possible to insert directly the Unit (using its unique number) by compiling the **“Selected BACnet Engineering Unit”** field; or by selecting with the fields **“Select the Type”** and **“Select unit”** the Type/Unit desired. If the second way is used, is necessary to press the **“Select Engineering Unit”** button for confirm the choice.

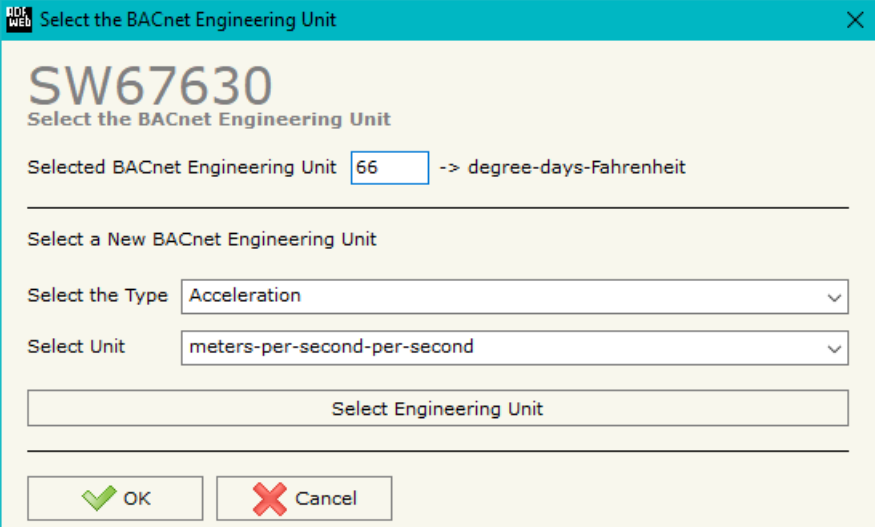

Figure 6: “Select the BACnet Engineering Unit” window

BACNET EDE FILE:

By pressing the **“BACnet EDE File”** button it is possible to save the EDE file for the BACnet Master.

UPDATE DEVICE:

By pressing the **“Update Device”** button, it is possible to load the created Configuration into the device; and also the Firmware, if necessary. This by using the Ethernet port.

If you don't know the actual IP address of the device you have to use this procedure:

- Turn OFF the Device;
- Put Dip1 of 'Dip-Switch A' in ON position;
- Turn ON the device
- Connect the Ethernet cable;
- Insert the IP **“192.168.2.205”**;
- Select which operations you want to do;
- Press the **“Execute update firmware”** button to start the upload;
- When all the operations are “OK” turn OFF the Device;
- Put Dip1 of 'Dip-Switch A' in OFF position;
- Turn ON the device.

If you know the actual IP address of the device, you have to use this procedure:

- Turn ON the Device with the Ethernet cable inserted;
- Insert the actual IP of the Converter;
- Select which operations you want to do;
- Press the **“Execute update firmware”** button to start the upload;
- When all the operations are “OK” the device automatically goes at Normal Mode.

At this point the configuration/firmware on the device is correctly updated.

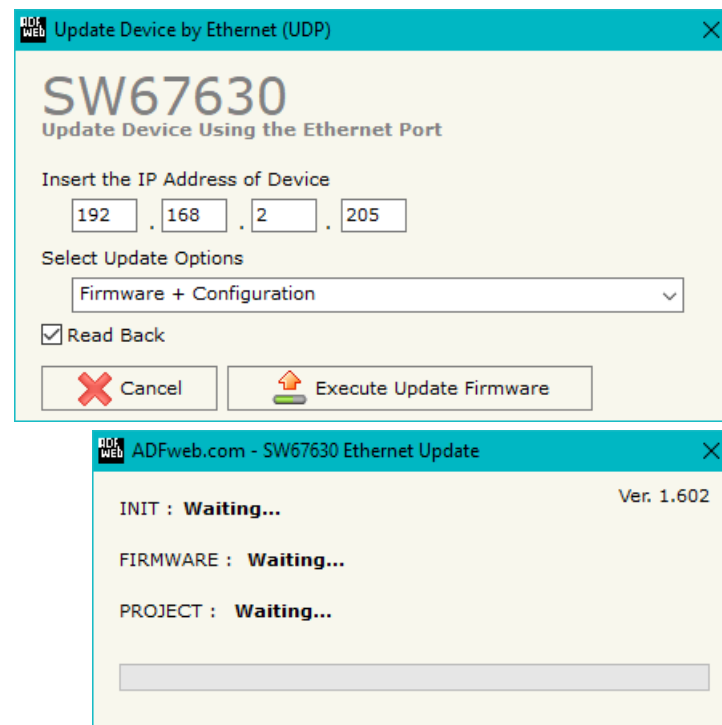

Figure 7: “Update device” windows



Note:

When you receive the device, for the first time, you also have to update the Firmware in the HD67630 device.



Warning:

If Fig. 8 appears when you try to do the Update try these points before seeking assistance:

- Try to repeat the operations for the updating;
- Try with another PC;
- Try to restart the PC;
- Check the LAN settings;
- If you are using the program inside a Virtual Machine, try to use in the main Operating System;
- If you are using Windows Seven, Vista, 8 or 10 make sure that you have the administrator privileges;
- In case you have to program more than one device, using the "UDP Update", you have to cancel the ARP table every time you connect a new device on Ethernet. For do this you have to launch the "Command Prompt" and write the command "arp -d". Pay attention that with Windows Vista, Seven, 8, 10 you have to launch the "Command Prompt" with Administrator Rights;
- Pay attention at Firewall lock.

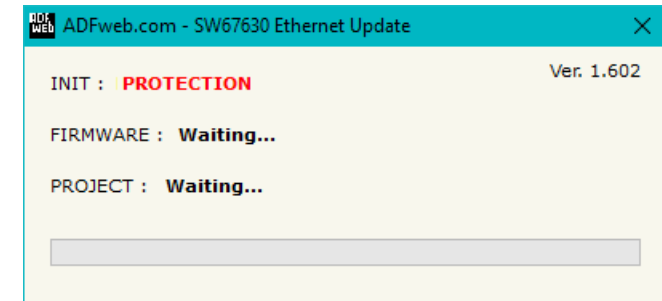
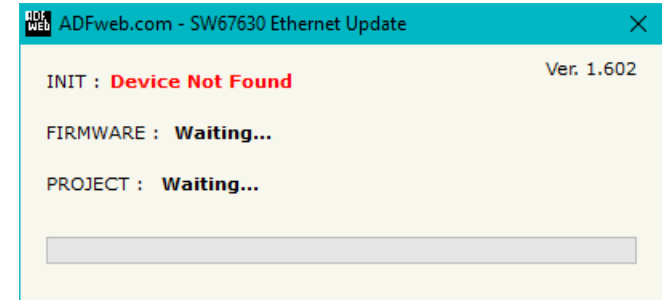

Figure 8: "Error" window



Warning:

In the case of HD67630 you have to use the software "SW67630": www.adfweb.com/download/filefold/SW67630.zip.

MECHANICAL DIMENSIONS:

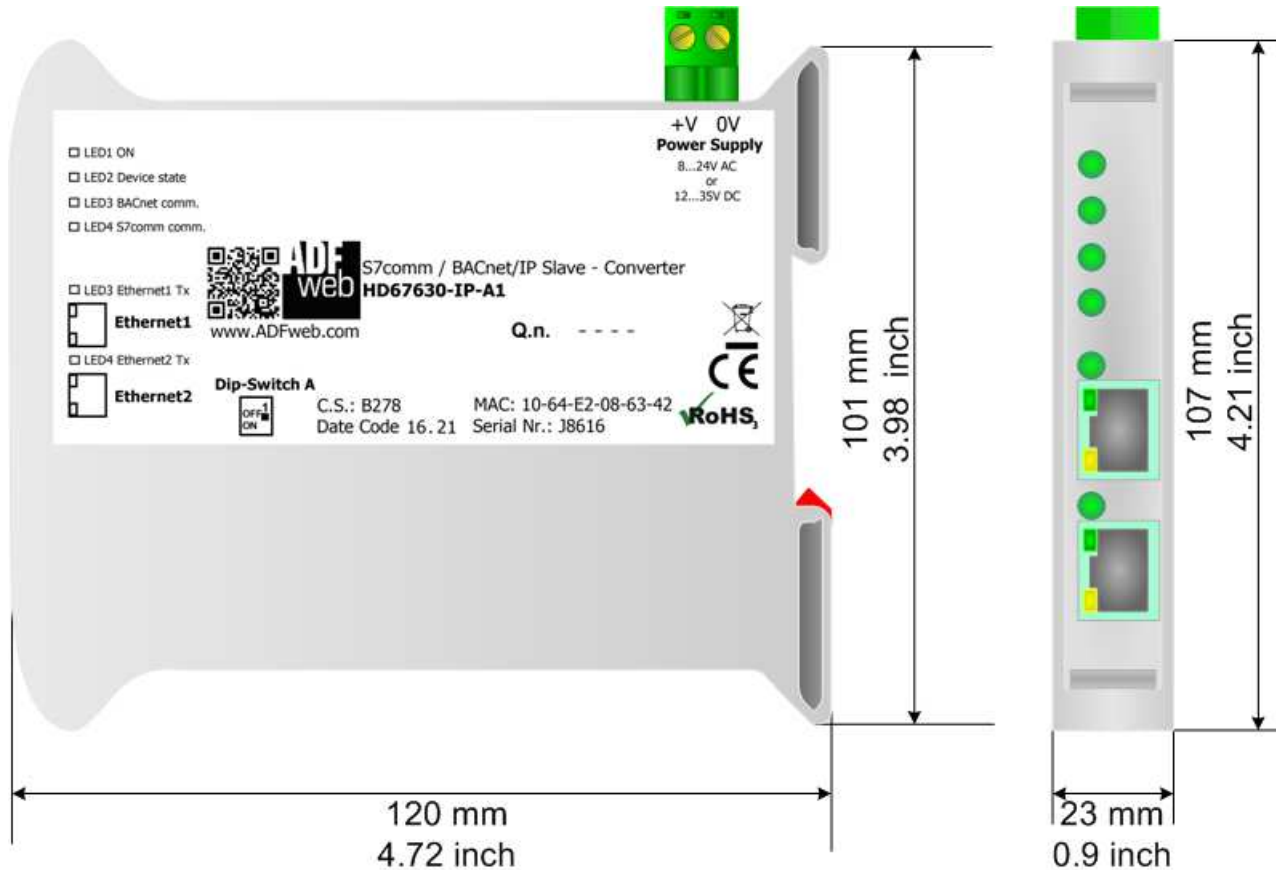

Housing: PVC
 Weight: 200g (Approx)

Figure 9a: Mechanical dimensions scheme for HD67630-IP-A1

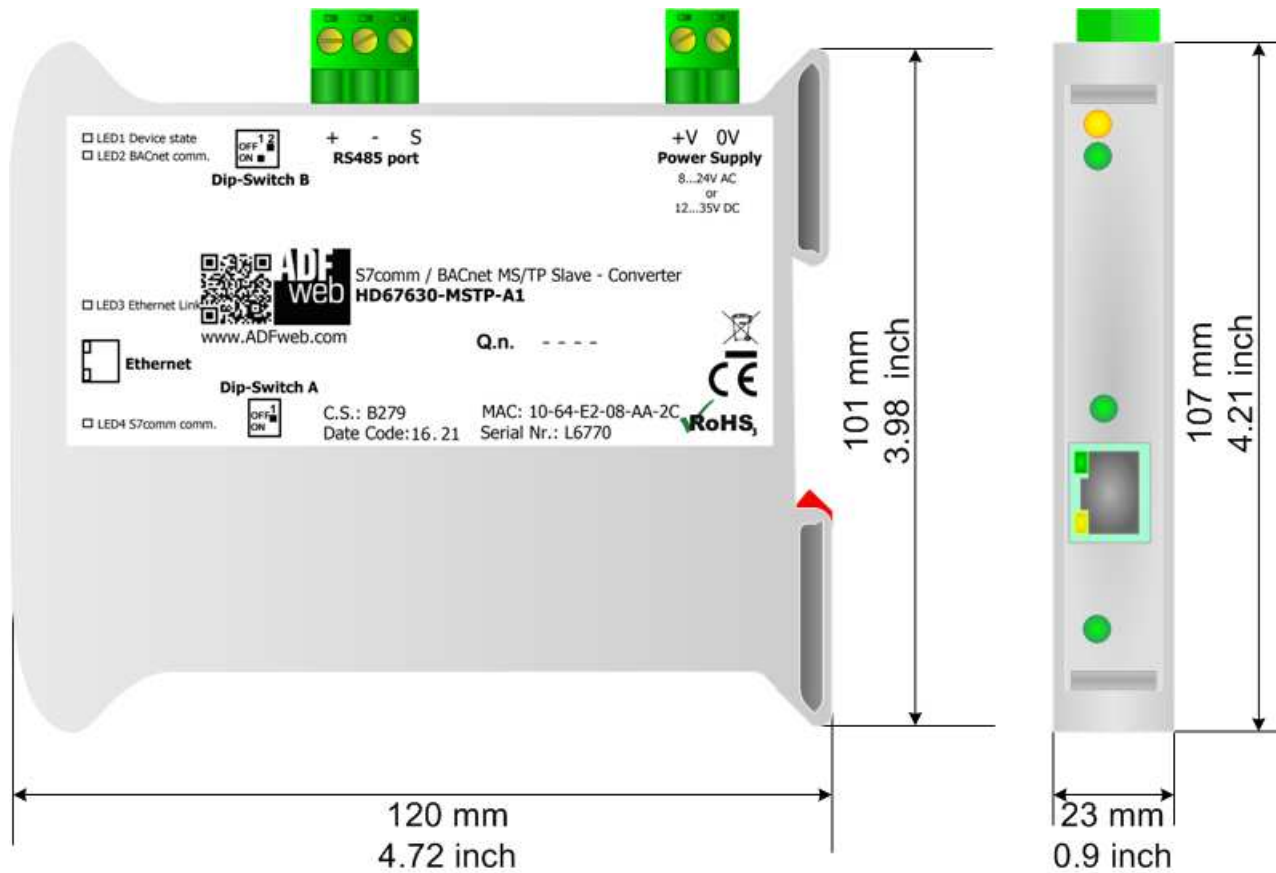

Housing: PVC
Weight: 200g (Approx)

Figure 9b: Mechanical dimensions scheme for HD67630-MSTP-A1

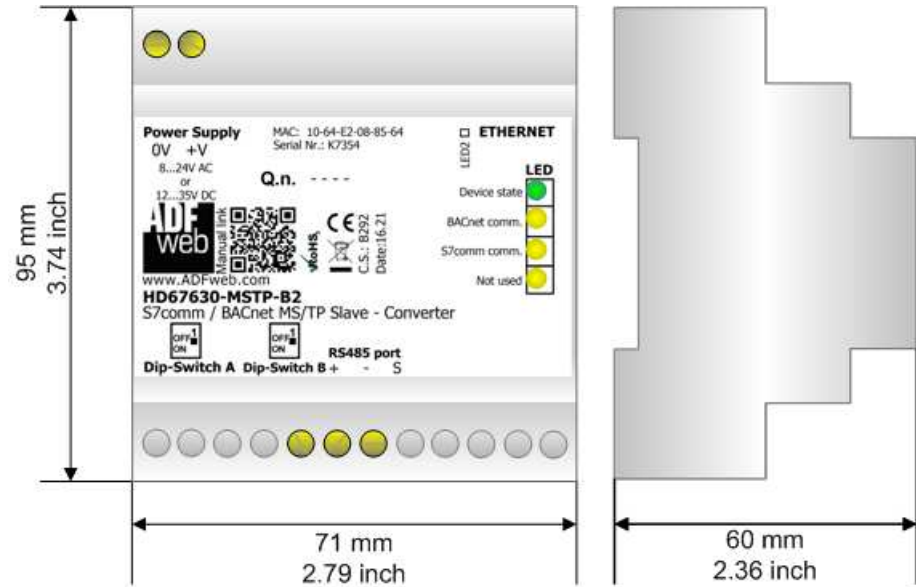

Housing: PVC
 Weight: 200g (Approx)

Figure 9c: Mechanical dimensions scheme for HD67630-MSTP-B2

ORDERING INFORMATIONS:

The ordering part number is formed by a valid combination of the following:

HD67630 - IP - A 1

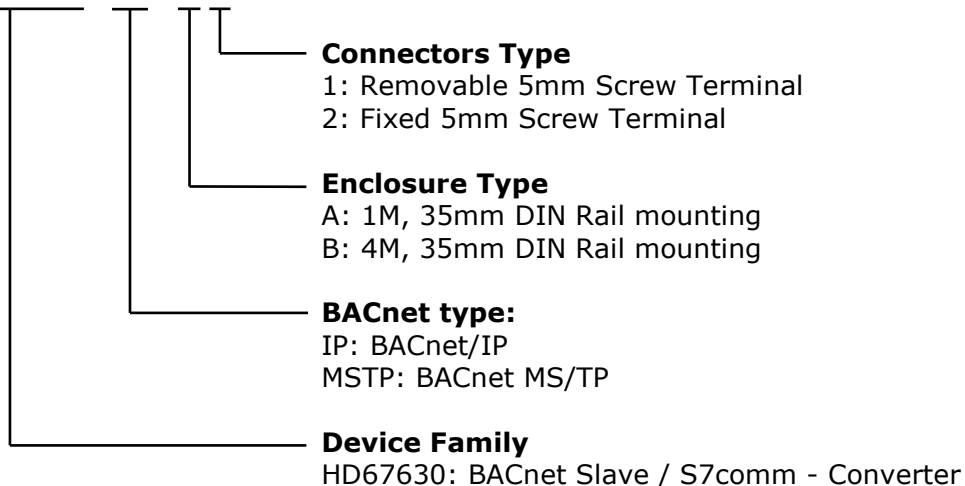

- Order Code: **HD67630-IP-A1** - BACnet/IP Slave / S7comm – Converter
- Order Code: **HD67630-MSTP-A1** - BACnet MS/TP Slave / S7comm – Converter
- Order Code: **HD67630-MSTP-B2** - BACnet MS/TP Slave / S7comm – Converter

ACCESSORIES:

- Order Code: **AC34011** - Rail DIN - Power Supply 220/240V AC 50/60Hz – 12 V DC
- Order Code: **AC34012** - Rail DIN - Power Supply 220/240V AC 50/60Hz – 24 V DC

DISCLAIMER:

All technical content within this document can be modified without notice. The content of the document is a under continual renewal. For losses due to fire, earthquake, third party access or other accidents, or intentional or accidental abuse, misuse, or use under abnormal conditions repairs are charged to the user. ADFweb.com S.r.l. will not be liable for accidental loss of use or inability to use this product, such as loss of business income. ADFweb.com S.r.l. shall not be liable for consequences of improper use.

OTHER REGULATIONS AND STANDARDS:**WEEE INFORMATION**

Disposal of old electrical and electronic equipment (as in the European Union and other European countries with separate collection systems).

— This symbol on the product or on its packaging indicates that this product may not be treated as household rubbish. Instead, it should be taken to an applicable collection point for the recycling of electrical and electronic equipment. If the product is disposed correctly, you will help prevent potential negative environmental factors and impact of human health, which could otherwise be caused by inappropriate disposal. The recycling of materials will help to conserve natural resources. For more information about recycling this product, please contact your local city office, your household waste disposal service or the shop where you purchased the product.

RESTRICTION OF HAZARDOUS SUBSTANCES DIRECTIVE

The device respects the 2002/95/EC Directive on the restriction of the use of certain hazardous substances in electrical and electronic equipment (commonly referred to as Restriction of Hazardous Substances Directive or RoHS).

CE MARKING

The product conforms with the essential requirements of the applicable EC directives.

WARRANTIES AND TECHNICAL SUPPORT:

For fast and easy technical support for your ADFweb.com SRL products, consult our internet support at www.adfweb.com. Otherwise contact us at the address support@adfweb.com

RETURN POLICY:

If while using your product you have any problem and you wish to exchange or repair it, please do the following:

- ➔ Obtain a Product Return Number (PRN) from our internet support at www.adfweb.com. Together with the request, you need to provide detailed information about the problem.
- ➔ Send the product to the address provided with the PRN, having prepaid the shipping costs (shipment costs billed to us will not be accepted).

If the product is within the warranty of twelve months, it will be repaired or exchanged and returned within three weeks. If the product is no longer under warranty, you will receive a repair estimate.



ADFweb.com S.r.l.
Via Strada Nuova, 17
IT-31010 Mareno di Piave
TREVISO (Italy)
Phone +39.0438.30.91.31
Fax +39.0438.49.20.99
www.adfweb.com

