

# User Manual

Revision 1.010  
English

## BACnet Slave / SNMP - Converter

(Order Code: HD67693-IP-A1, HD67693-MSTP-A1, HD67693-MSTP-B2)

For Website information:

[www.adfweb.com?Product=HD67693](http://www.adfweb.com?Product=HD67693)

For Price information:

[www.adfweb.com?Price=HD67693-IP-A1](http://www.adfweb.com?Price=HD67693-IP-A1)  
[www.adfweb.com?Price=HD67693-MSTP-A1](http://www.adfweb.com?Price=HD67693-MSTP-A1)  
[www.adfweb.com?Price=HD67693-MSTP-B2](http://www.adfweb.com?Price=HD67693-MSTP-B2)

### Benefits and Main Features:

- ✦ Very easy to configure
- ✦ Temperature range: -40°C/+85°C (-40°F/+185°F)



For others BACnet products see also the following link:

### Converter BACnet to

[www.adfweb.com?Product=HD67056](http://www.adfweb.com?Product=HD67056)  
[www.adfweb.com?Product=HD67086](http://www.adfweb.com?Product=HD67086)  
[www.adfweb.com?Product=HD67670](http://www.adfweb.com?Product=HD67670)  
[www.adfweb.com?Product=HD67671](http://www.adfweb.com?Product=HD67671)  
[www.adfweb.com?Product=HD67672](http://www.adfweb.com?Product=HD67672)  
[www.adfweb.com?Product=HD67673](http://www.adfweb.com?Product=HD67673)  
[www.adfweb.com?Product=HD67674](http://www.adfweb.com?Product=HD67674)  
[www.adfweb.com?Product=HD67675](http://www.adfweb.com?Product=HD67675)  
[www.adfweb.com?Product=HD67676](http://www.adfweb.com?Product=HD67676)  
[www.adfweb.com?Product=HD67677](http://www.adfweb.com?Product=HD67677)  
[www.adfweb.com?Product=HD67678](http://www.adfweb.com?Product=HD67678)  
[www.adfweb.com?Product=HD67679](http://www.adfweb.com?Product=HD67679)  
[www.adfweb.com?Product=HD67680](http://www.adfweb.com?Product=HD67680)  
[www.adfweb.com?Product=HD67681](http://www.adfweb.com?Product=HD67681)  
[www.adfweb.com?Product=HD67682](http://www.adfweb.com?Product=HD67682)  
[www.adfweb.com?Product=HD67683](http://www.adfweb.com?Product=HD67683)  
[www.adfweb.com?Product=HD67684](http://www.adfweb.com?Product=HD67684)  
[www.adfweb.com?Product=HD67685](http://www.adfweb.com?Product=HD67685)  
[www.adfweb.com?Product=HD67686](http://www.adfweb.com?Product=HD67686)  
[www.adfweb.com?Product=HD67802](http://www.adfweb.com?Product=HD67802)  
[www.adfweb.com?Product=HD67833](http://www.adfweb.com?Product=HD67833)

**(M-Bus Master)**  
**(M-Bus Wireless)**  
**(DMX)**  
**(Modbus Master)**  
**(Modbus Slave)**  
**(Modbus TCP Master)**  
**(Modbus TCP Slave)**  
**(PROFIBUS Master)**  
**(PROFIBUS Slave)**  
**(CAN)**  
**(CANopen)**  
**(PROFINET)**  
**(DeviceNet Master)**  
**(DeviceNet Slave)**  
**(EtherNet/IP)**  
**(NMEA 2000)**  
**(Ethernet)**  
**(J1939)**  
**(BACnet)**  
**(KNX)**  
**(DALI)**

Do you have an your customer protocol?

[www.adfweb.com?Product=HD67003](http://www.adfweb.com?Product=HD67003)

Do you need to choose a device? do you want help?

[www.adfweb.com?Cmd=helpme](http://www.adfweb.com?Cmd=helpme)



User Manual

**INDEX:**

	Page
INDEX	2
UPDATED DOCUMENTATION	2
REVISION LIST	2
WARNING	2
TRADEMARKS	2
SECURITY ALERT	3
EXAMPLE OF CONNECTION	4
CONNECTION SCHEME	6
CHARACTERISTICS	9
CONFIGURATION	9
POWER SUPPLY	10
FUNCTION MODES	11
LEDS (for HD67693-IP-A1)	12
LEDS (for HD67693-MSTP-A1/B2)	13
ETHERNET	14
RS485 (HD67679-MSTP-A1/B2)	15
USE OF COMPOSITOR SW67693	16
NEW CONFIGURATION / OPEN CONFIGURATION	17
SOFTWARE OPTIONS	18
SET COMMUNICATION	20
SET BACNET ACCESS	22
SET SNMP ACCESS	24
OBJECTS MAP	26
SNMP MIB	26
UPDATE DEVICE	27
SNMP COMMUNICATION	29
MECHANICAL DIMENSIONS	34
ORDERING INFORMATIONS	36
ACCESSORIES	36
DISCLAIMER	37
OTHER REGULATIONS AND STANDARDS	37
WARRANTIES AND TECHNICAL SUPPORT	38
RETURN POLICY	38

**UPDATED DOCUMENTATION:**

Dear customer, we thank you for your attention and we remind you that you need to check that the following document is:

- ✚ Updated
- ✚ Related to the product you own

To obtain the most recently updated document, note the “document code” that appears at the top right-hand corner of each page of this document.

With this “Document Code” go to web page [www.adfweb.com/download/](http://www.adfweb.com/download/) and search for the corresponding code on the page. Click on the proper “Document Code” and download the updates.

**REVISION LIST:**

Revision	Date	Author	Chapter	Description
1.000	25/05/2015	Ff	All	First Release
1.001	02/09/2015	Ff	All	Revision
1.010	27/02/2017	Ff	All	New software version

**WARNING:**

ADFweb.com reserves the right to change information in this manual about our product without warning.  
ADFweb.com is not responsible for any error this manual may contain.

**TRADEMARKS:**

All trademarks mentioned in this document belong to their respective owners.

**SECURITY ALERT:****GENERAL INFORMATION**

To ensure safe operation, the device must be operated according to the instructions in the manual. When using the device, legal and safety regulation are required for each individual application. The same applies also when using accessories.

**INTENDED USE**

Machines and systems must be designed so the faulty conditions do not lead to a dangerous situation for the operator (i.e. independent limit switches, mechanical interlocks, etc.).

**QUALIFIED PERSONNEL**

The device can be used only by qualified personnel, strictly in accordance with the specifications. Qualified personnel are persons who are familiar with the installation, assembly, commissioning and operation of this equipment and who have appropriate qualifications for their job.

**RESIDUAL RISKS**

The device is state-of-the-art and is safe. The instruments can represent a potential hazard if they are inappropriately installed and operated by untrained personnel. These instructions refer to residual risks with the following symbol:



This symbol indicates that non-observance of the safety instructions is a danger for people that could lead to serious injury or death and / or the possibility of damage.

**CE CONFORMITY**

The declaration is made by our company. You can send an email to [support@adfweb.com](mailto:support@adfweb.com) or give us a call if you need it.

**EXAMPLES OF CONNECTION:**

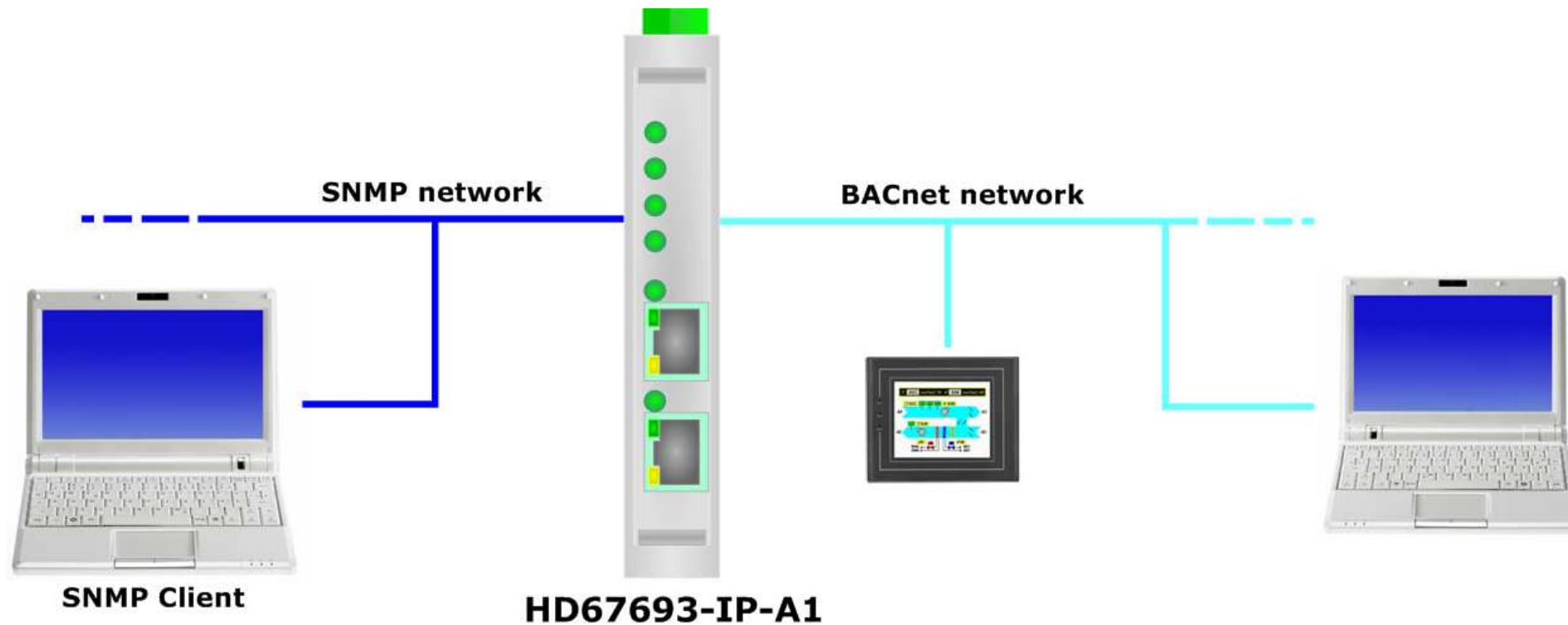

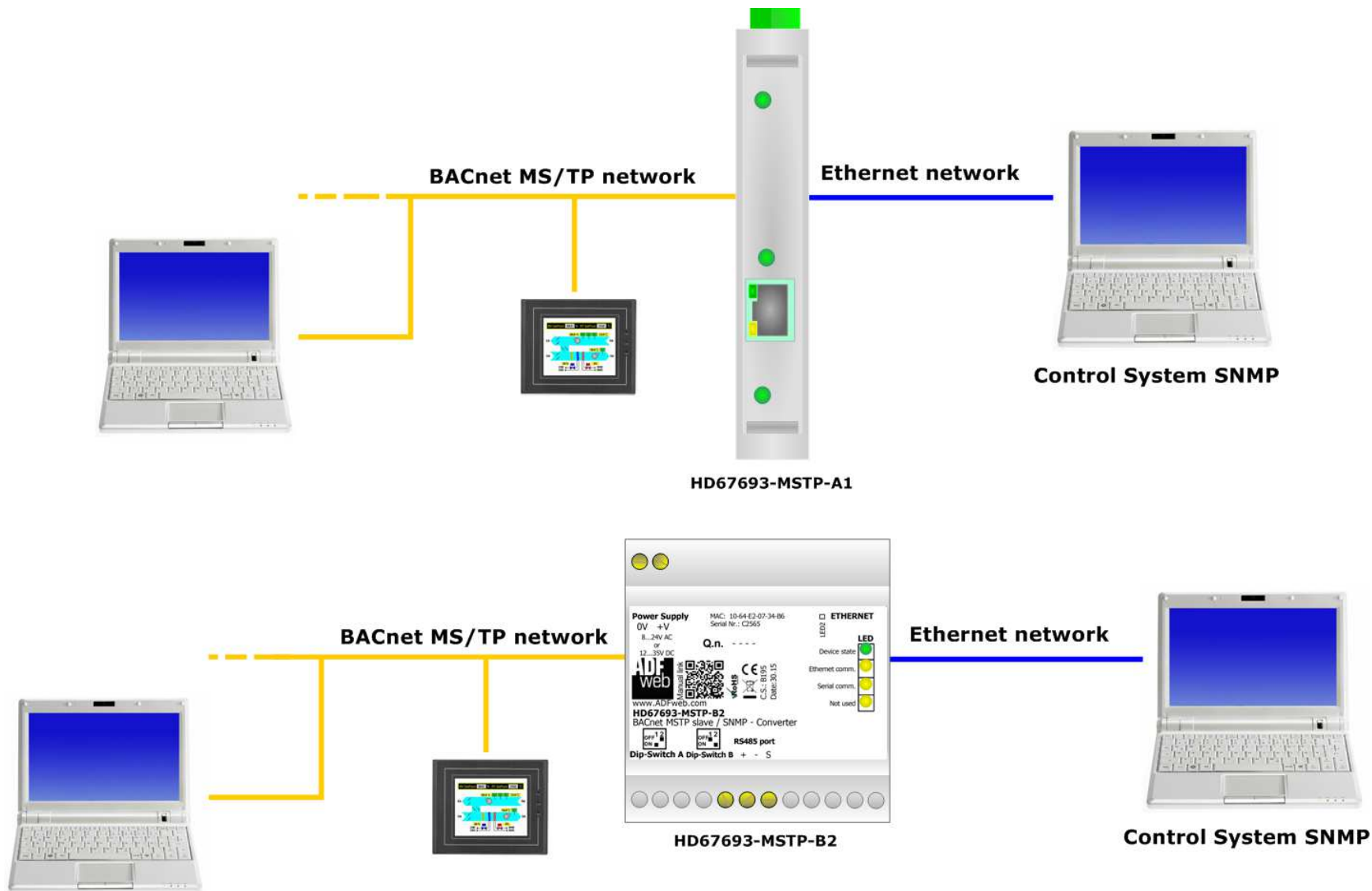

**CONNECTION SCHEME:**

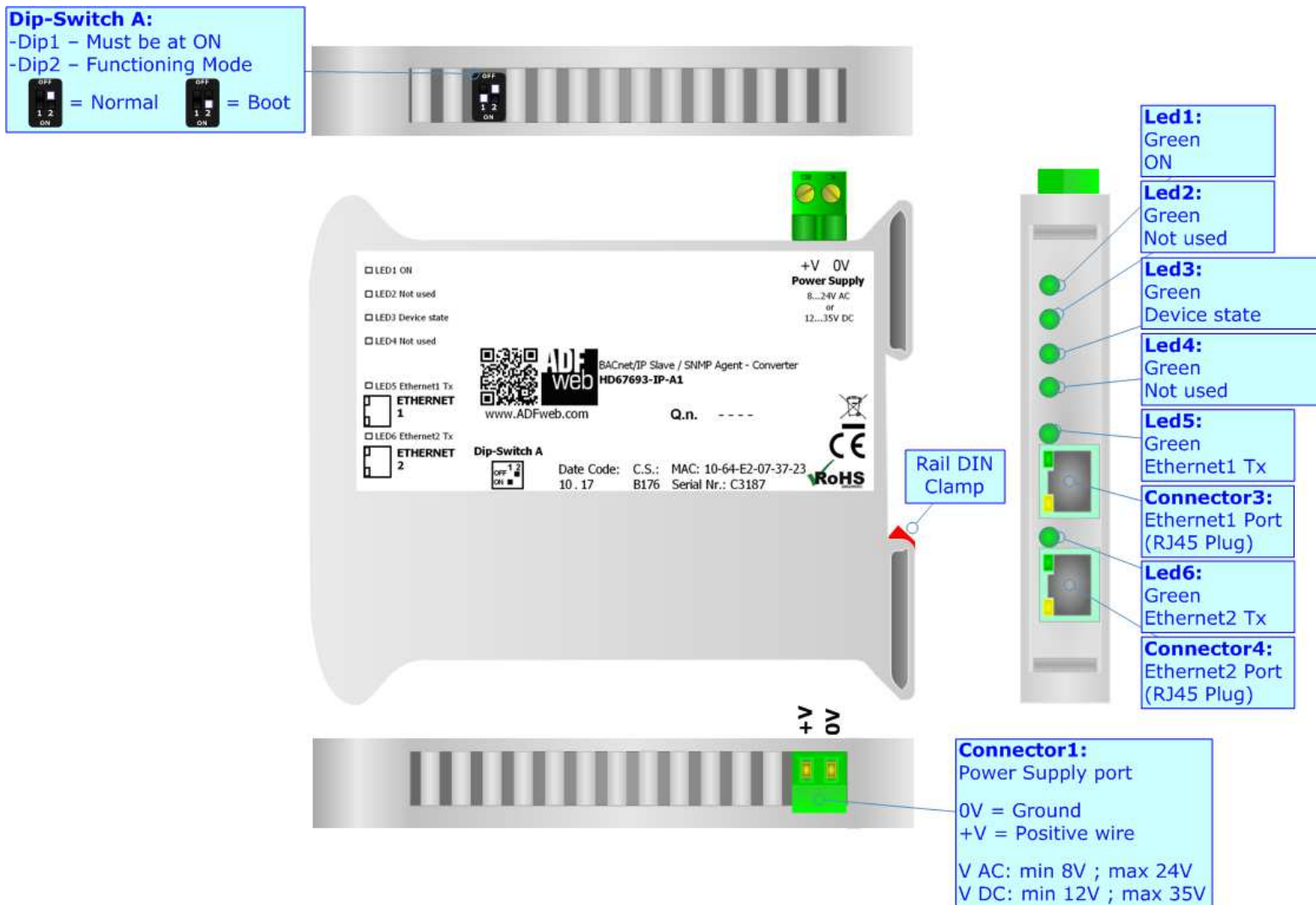
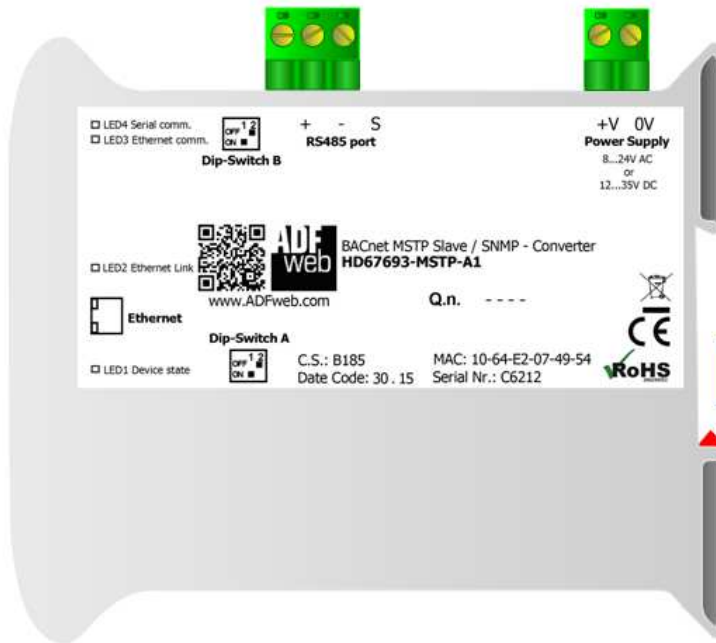

Figure 1a: Connection scheme for HD67693-IP-A1

**Dip-Switch A:**  
 -Dip1 – Must be at ON  
 -Dip2 – Functioning Mode  
 = Normal = Boot



**Led4:**  
Yellow  
Serial  
Communication

**Led3:**  
Green  
Ethernet  
Communication

**Led2:**  
Green  
Ethernet Link

**Connector5:**  
Ethernet Port  
(RJ45 Plug)

**Led1:**  
Green  
Device State

**Connector1:**  
Power Supply port  
 0V = Ground  
 +V = Positive wire  
 V AC: min 8V ; max 24V  
 V DC: min 12V ; max 35V

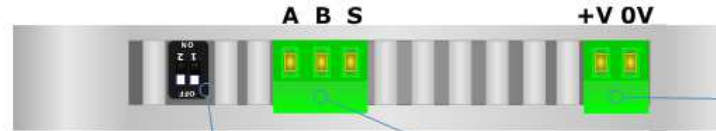

**Dip-Switch B:**  
 -Dip1 – RS485 Termination Resistor  
 = Open = 120 Ohm  
 -Dip2 – Not used

**Connector3:**  
 RS485 (Isolated port)  
 S = Shield\* (to Isolated Ground)  
 B = Negative wire  
 A = Positive wire

Figure 1b: Connection scheme for HD67693-MSTP-A1



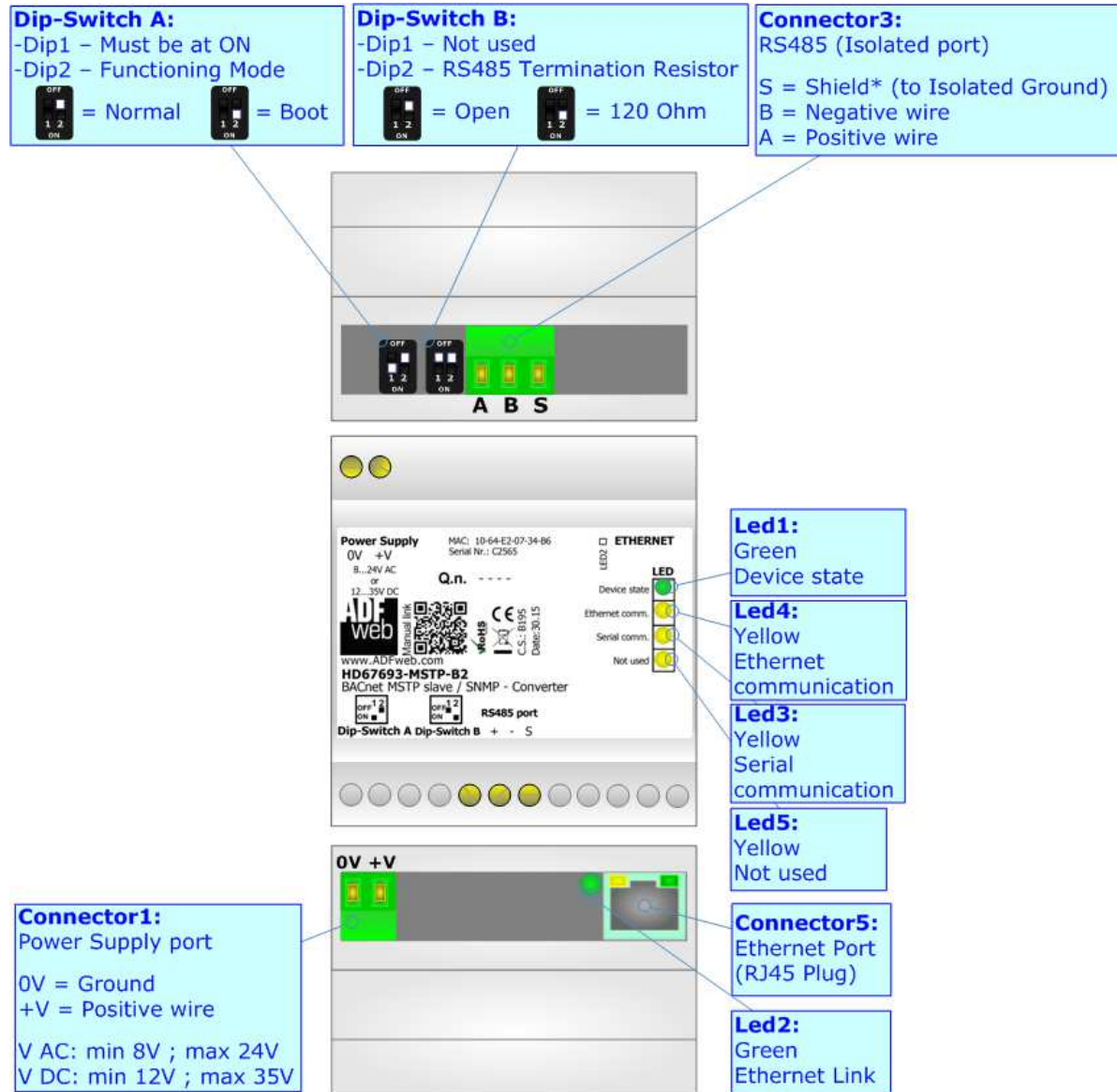

Figure 1c: Connection scheme for HD67693-MSTP-B2



**CHARACTERISTICS:**

The HD67679-xxx-A1 and HD67679-xxx-B2 are BACnet Slave / SNMP Agent - Converter.

It allows the following characteristics:

- Up to 2000 BACnet objects (Read+Write);
- Two-directional information between BACnet and SNMP;
- Mountable on 35mm Rail DIN;
- Wide power supply input range: 8...24V AC or 12...35V DC;
- Wide temperature range: -40°C / 85°C [-40°F / +185°F].



**CONFIGURATION:**

You need Compositor SW67693 software on your PC in order to perform the following:

- Define the parameter of BACnet line;
- Define the parameter of SNMP line;
- Define BACnet objects that contains the data arrived from a SNMP Manager;
- Define BACnet objects that contains the data to send to the SNMP Manager;
- Update the device.

**POWER SUPPLY:**

The devices can be powered at 8...24V AC and 12...35V DC. For more details see the two tables below.

VAC 		VDC 	
Vmin	Vmax	Vmin	Vmax
8V	24V	12V	35V

Consumption at 24V DC:

Device	Consumption [W/VA]
HD67693-IP-A1	3.5
HD67693-MSTP-A1/B2	3.5

**Connector1:**  
 Power Supply port  
 0V = Ground  
 +V = Positive wire  
 V AC: min 8V ; max 24V  
 V DC: min 12V ; max 35V

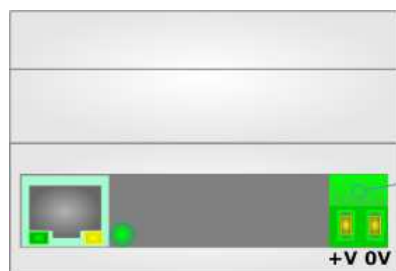

**Connector1:**  
 Power Supply port  
 0V = Ground  
 +V = Positive wire  
 V AC: min 8V ; max 24V  
 V DC: min 12V ; max 35V

**Caution: Not reverse the polarity power**

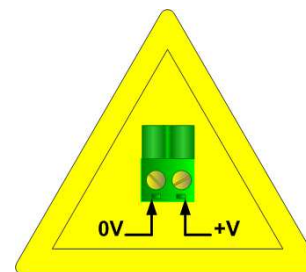

HD67693-IP-A1  
 HD67693-MSTP-A1

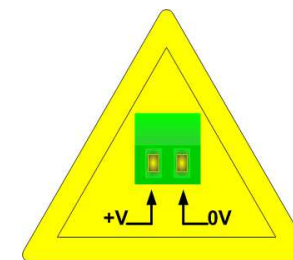

HD67693-MSTP-B2

**FUNCTION MODES:**

The device has got two functions mode depending of the position of the 'Dip2 of Dip-Switch A':

- The first, with 'Dip2 of Dip-Switch A' at "OFF" position, is used for the normal working of the device.
- The second, with 'Dip2 of Dip-Switch A' at "ON" position, is used for upload the Project and/or Firmware.

For the operations to follow for the updating, see 'UPDATE DEVICE' section.

According to the functioning mode, the LEDs will have specifics functions, see 'LEDS' section.

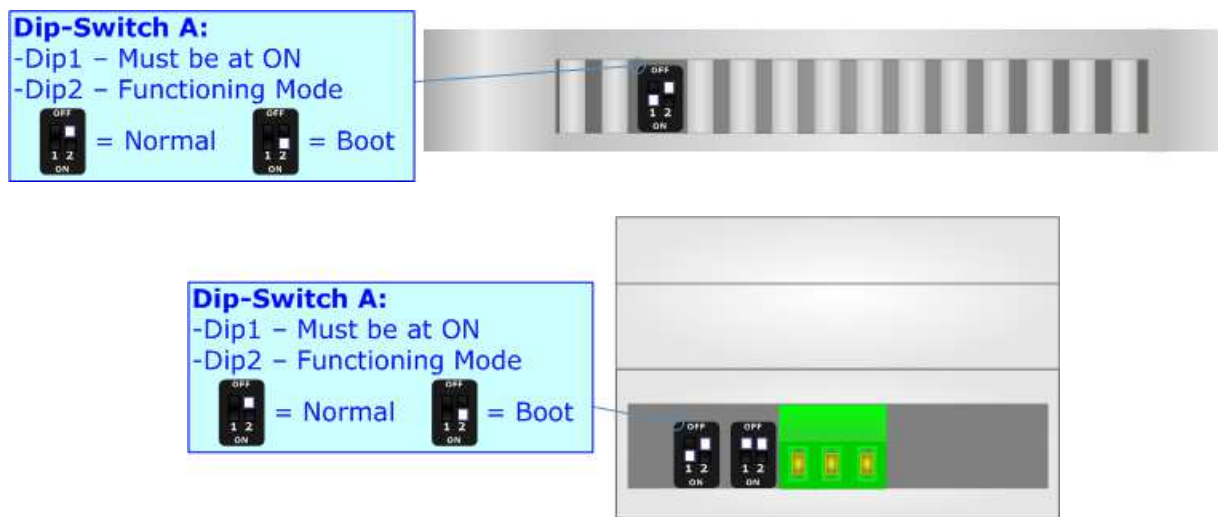

**Warning:** Dip1 of 'Dip-Switch A' must be at ON position for working even if the Ethernet cable isn't inserted.

**LEDS (for HD67693-IP-A1):**

The device has got six LEDs that are used to give information about the functioning status.  
The various meanings of the LEDs are described in the table below.

LED	Normal Mode	Boot Mode
1: ON [supply voltage ] (green)	<b>ON:</b> Device powered <b>OFF:</b> Device not powered	<b>ON:</b> Device powered <b>OFF:</b> Device not powered
2: Not used (green)	<b>OFF</b>	<b>Blinks quickly:</b> Boot state <b>Blinks very slowly (~0.5Hz):</b> update in progress
3: Device State (green)	Blinks slowly (~1Hz)	<b>Blinks quickly:</b> Boot state <b>Blinks very slowly (~0.5Hz):</b> update in progress
4: Not used (green)	<b>OFF</b>	<b>Blinks quickly:</b> Boot state <b>Blinks very slowly (~0.5Hz):</b> update in progress
5: Ethernet1 Tx (green)	Blinks when a Ethernet frame is transmitted	<b>Blinks quickly:</b> Boot state <b>Blinks very slowly (~0.5Hz):</b> update in progress
6: Ethernet2 Tx (green)	Blinks when a Ethernet frame is transmitted	<b>Blinks quickly:</b> Boot state <b>Blinks very slowly (~0.5Hz):</b> update in progress

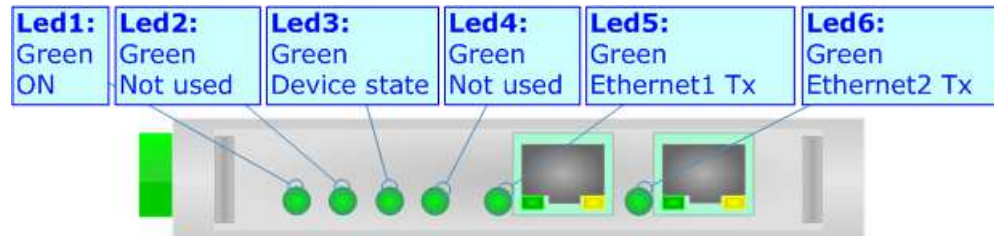

**LEDS (for HD67693-MSTP-A1/B2):**

The device has got four LEDs (five the -B2 version) that are used to give information about the functioning status. The various meanings of the LEDs are described in the table below.

LED	Normal Mode	Boot Mode
1: Device State	Blinks slowly (~1Hz)	<b>ON:</b> Device powered <b>OFF:</b> Device not powered
2: Ethernet Link	<b>ON:</b> Ethernet cable connected <b>OFF:</b> Ethernet cable disconnected	<b>Blinks quickly:</b> Boot state <b>Blinks very slowly (~0.5Hz):</b> update in progress
3: Ethernet comm.	Blinks quickly when SNMP request is received	<b>Blinks quickly:</b> Boot state <b>Blinks very slowly (~0.5Hz):</b> update in progress
4: Serial comm.	Blinks quickly when BACnet request is received	<b>Blinks quickly:</b> Boot state <b>Blinks very slowly (~0.5Hz):</b> update in progress
5: Not Used	OFF	<b>Blinks quickly:</b> Boot state <b>Blinks very slowly (~0.5Hz):</b> update in progress

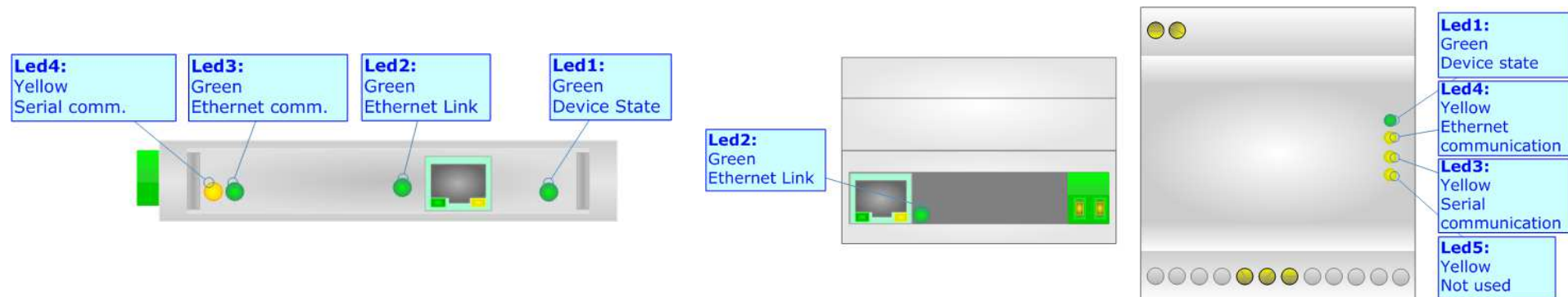

**ETHERNET:**

The BACnet/IP connection (HD67693-IP-A1), SNMP connection and the updating of the Converter must be made using Connector3 and/or Connector4 of HD67693 with at least a Category 5E cable. The maximum length of the cable should not exceed 100m. The cable has to conform to the T568 norms relative to connections in cat.5 up to 100 Mbps. To connect the device to an Hub/Switch is recommended the use of a straight cable, to connect the device to a PC/PLC/other is recommended the use of a cross cable.

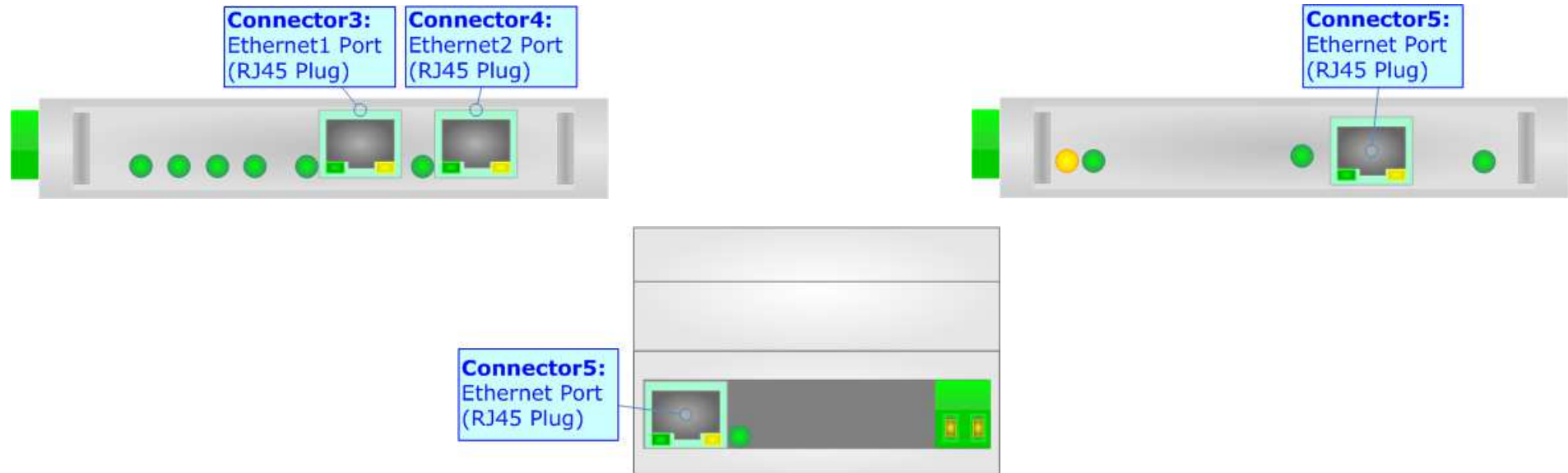

**RS485 (HD67693-MSTP-A1/B2):**

To terminate the RS485 line with a 120Ω resistor it is necessary to put ON dip 1, like in figure.

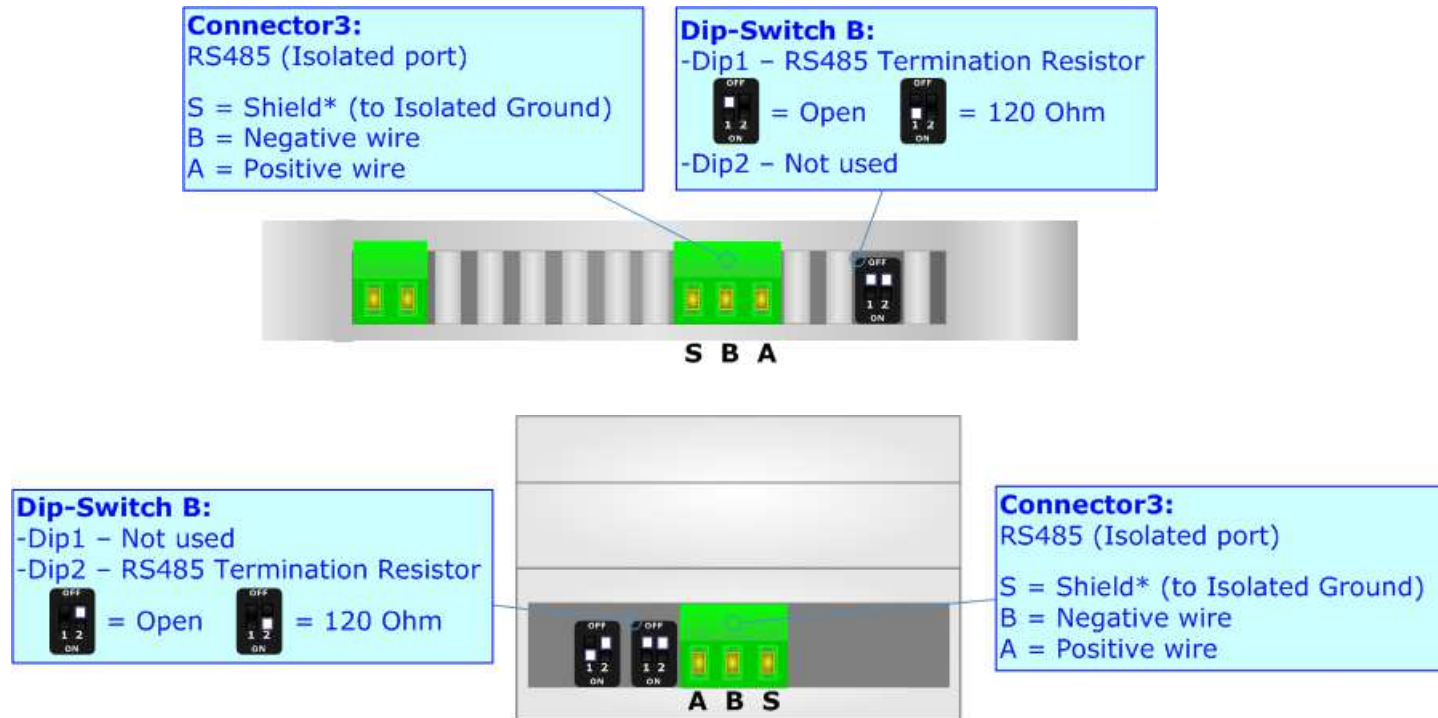

The maximum length of the cable should be 1200m (4000 feet).

Here some codes of cables:

- Belden: p/n 8132 - 2x 28AWG stranded twisted pairs conductor + foil shield + braid shield;
- Belden p/n 82842 - 2x 24AWG stranded twisted pairs conductor + foil shield + braid shield;
- Tasker: p/n C521 - 1x 24AWG twisted pair conductor + foil shield + braid shield;
- Tasker: p/n C522 - 2x 24AWG twisted pairs conductor + foil shield + braid shield.



## USE OF COMPOSITOR SW67693:

To configure the Converter, use the available software that runs with Windows called SW67693. It is downloadable on the site [www.adfweb.com](http://www.adfweb.com) and its operation is described in this document. (*This manual is referenced to the last version of the software present on our web site*). The software works with MSWindows (XP, Vista, Seven, 8, 10; 32/64bit).

When launching the SW67693, the window below appears (Fig. 2).



### Note:

It is necessary to have installed .Net Framework 4.

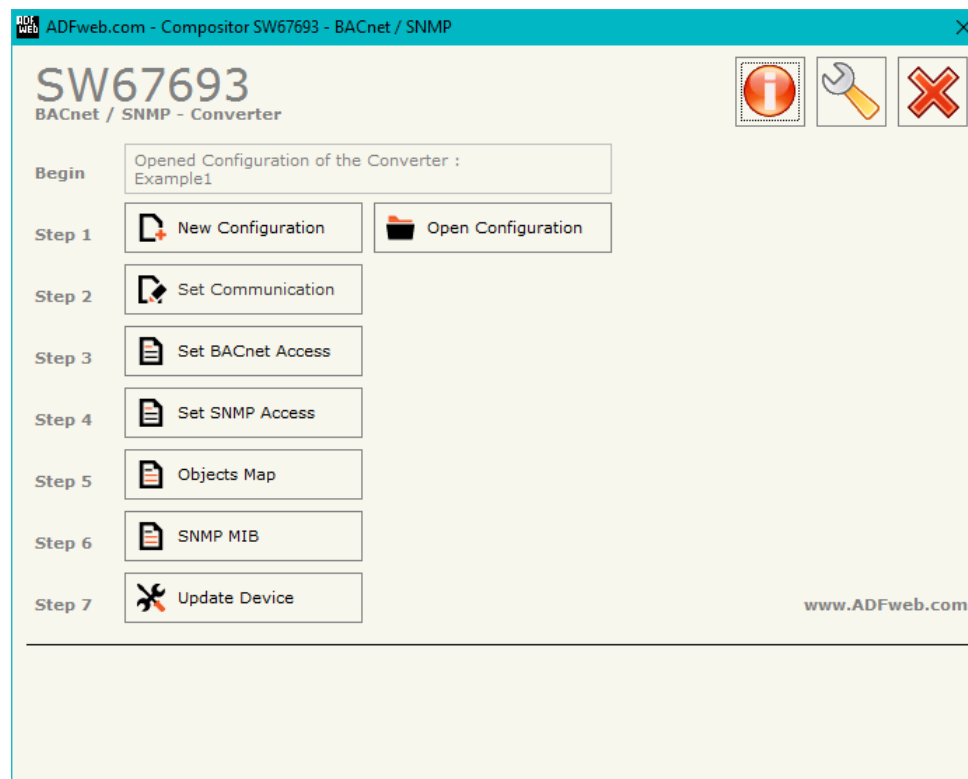
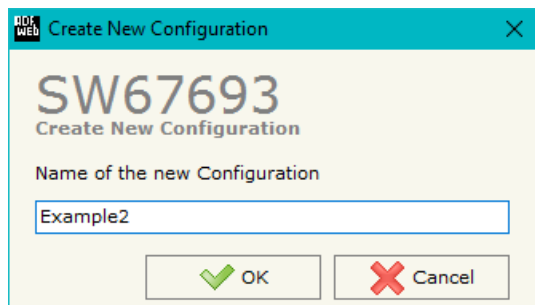

Figure 2: Main window for SW67693

**NEW CONFIGURATION / OPEN CONFIGURATION:**

The “**New Configuration**” button creates the folder which contains the entire device’s configuration.



A device’s configuration can also be imported or exported:

- To clone the configurations of a programmable “BACnet slave / SNMP Agent - Converter” in order to configure another device in the same manner, it is necessary to maintain the folder and all its contents;
- To clone a project in order to obtain a different version of the project, it is sufficient to duplicate the project folder with another name and open the new folder with the button “**Open Configuration**”.

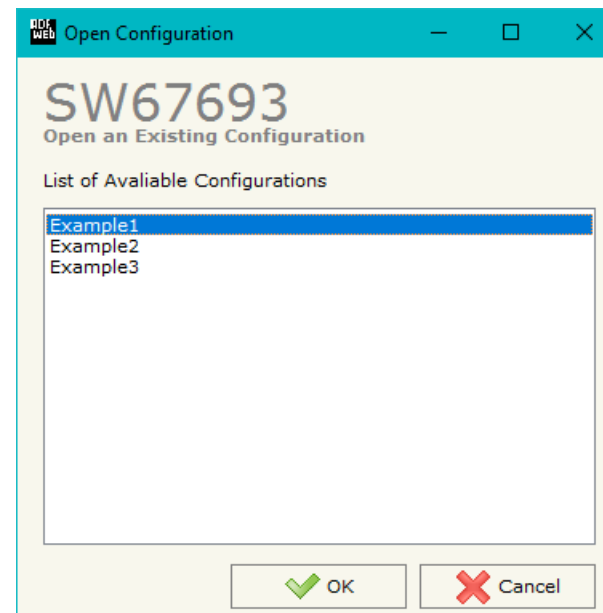

**SOFTWARE OPTIONS:**

By pressing the “**Settings**” () button there is the possibility to change the language of the software and check the updatings for the compositor.

In the section “Language” it is possible to change the language of the software.

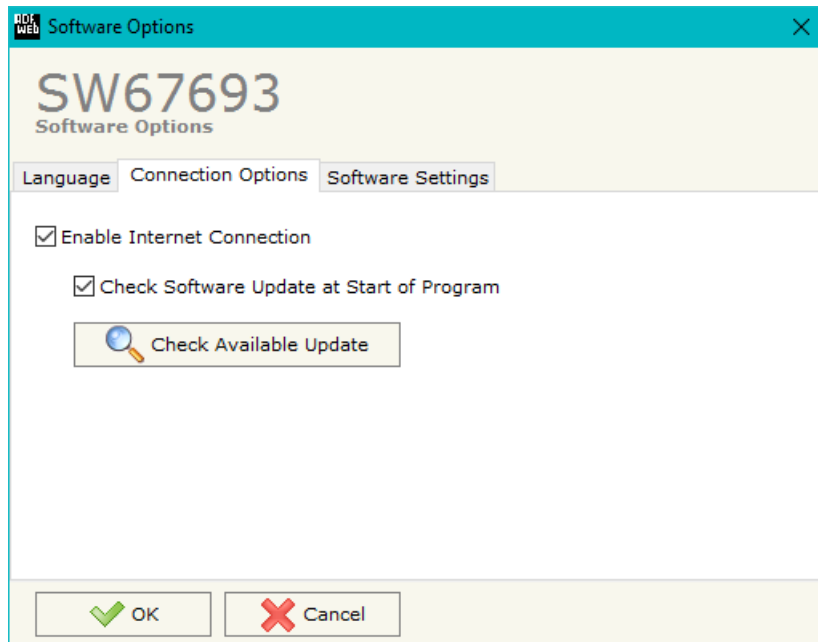

In the section “Connection Options”, it is possible to check if there are some updatings of the software compositor in ADFweb.com website. Checking the option “**Check Software Update at Start of Program**”, the SW67693 check automatically if there are updatings when it is launched.

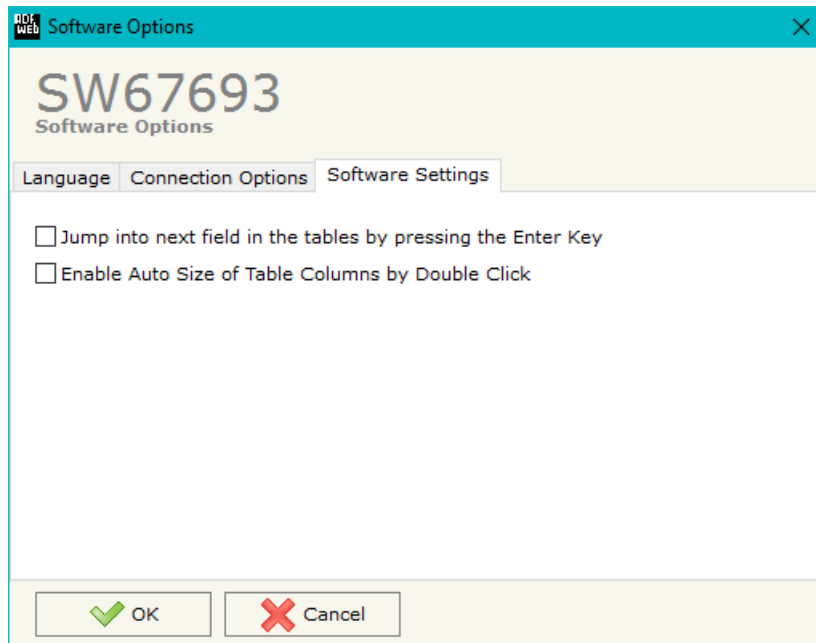

In the section "Software Settings", it is possible to enable/disable some keyboard's commands for an easier navigation inside the tables contained in the different sections of the software.

## SET COMMUNICATION:

This section define the fundamental communication parameters of two buses, BACnet and SNMP.

By Pressing the **"Set Communication"** button from the main window for SW67693 (Fig. 2) the window "Set Communication" appears (Fig. 3).

In the section "BACnet Type" is possible to select the type of BACnet to use from:

- BACnet/IP (over Ethernet);
- BACnet MS/TP (over RS485).

If selected "BACnet/IP" the means of the fields for "BACnet" are:

- In the field **"IP ADDRESS"** the IP address of the converter is defined;
- In the field **"SUBNET Mask"** the SubNet Mask of the converter is defined;
- In the field **"GATEWAY"** the default gateway of the network is defined. This feature can be enabled or disabled pressing the Check Box field. This feature is used for going out of the net;
- In the field **"Port"** the port number used for BACnet communication is defined. The default port used for BACnet communication is 47808, but is possible to insert any value (except 10000 and 10001);
- In the field **"BACnet Device Name"** the name for BACnet side of the converter is defined;
- In the field **"Device Identifier"** the Device Instance for BACnet side of the converter is defined (Used for the Device Identifier);
- If the field **"BACnet description up to 32 chars"** is checked, the description for the BACnet Objects can be up to 32 chars long.

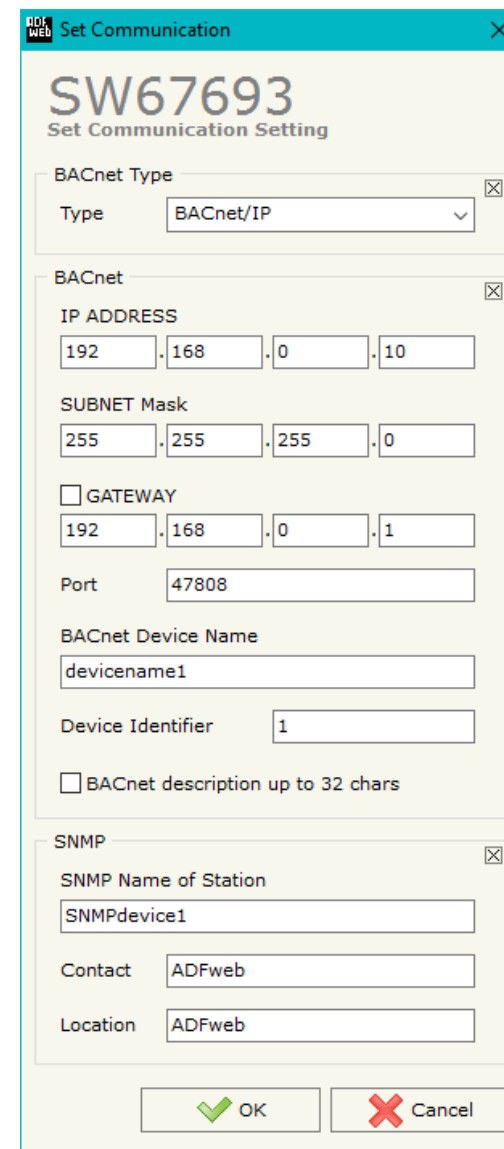

The screenshot shows the 'Set Communication' window for device SW67693. The window is titled 'Set Communication' and has a close button in the top right corner. The main title is 'SW67693 Set Communication Setting'. The window is divided into several sections:

- BACnet Type:** A dropdown menu showing 'BACnet/IP'.
- BACnet:** A section with a close button containing:
  - IP ADDRESS:** Four input fields with values 192, 168, 0, and 10.
  - SUBNET Mask:** Four input fields with values 255, 255, 255, and 0.
  - GATEWAY:** A checkbox (unchecked) and four input fields with values 192, 168, 0, and 1.
  - Port:** An input field with the value 47808.
  - BACnet Device Name:** An input field with the value devicename1.
  - Device Identifier:** An input field with the value 1.
  - BACnet description up to 32 chars:** A checkbox (unchecked).
- SNMP:** A section with a close button containing:
  - SNMP Name of Station:** An input field with the value SNMPdevice1.
  - Contact:** An input field with the value ADFweb.
  - Location:** An input field with the value ADFweb.

At the bottom of the window, there are two buttons: 'OK' (with a green checkmark) and 'Cancel' (with a red X).

Figure 3a: "Set Communication" window

If selected "BACnet MS/TP" the means of the fields for "BACnet" are:

- In the field "**Baudrate**" the baud rate of the BACnet line is defined;
- In the field "**Parity**" the parity of the line is defined;
- In the field "**BACnet Device Name**" the name for BACnet side of the converter is defined;
- In the field "**MAC Address**" the MAC of BACnet node (from 0 to 254) is defined;
- The field "**Max Master**" specifies the highest allowable address for master nodes. The value shall be less than or equal to 127;
- The field "**Max Info Frames**" specifies the maximum number of information frames the node may send before it must pass the token;
- In the field "**Device Instance**" it is possible to assign a number to the BACnet node (Used for the Device Identifier);
- In the field "**Network**" the BACnet MS/TP network number is defined;
- If the field "**BACnet description up to 32 chars**" is checked, the description for the BACnet Objects can be up to 32 chars long.

If selected "BACnet MS/TP" the means of the fields for "Ethernet Update" are:

- In the field "**IP ADDRESS**" the IP address of the converter is defined (updating and SNMP);
- In the field "**SUBNET Mask**" the SubNet Mask of the converter is defined;
- In the field "**GATEWAY**" the default gateway of the network is defined. This feature can be enabled or disabled pressing the Check Box field. This feature is used for going out of the net.

The means of the fields for "SNMP" are:

- In the field "**SNMP Name of Station**" the name for SNMP Agent station is defined;
- In the field "**Contact**" the contact for SNMP Agent station is defined;
- In the field "**Location**" the location for SNMP Agent station is defined.

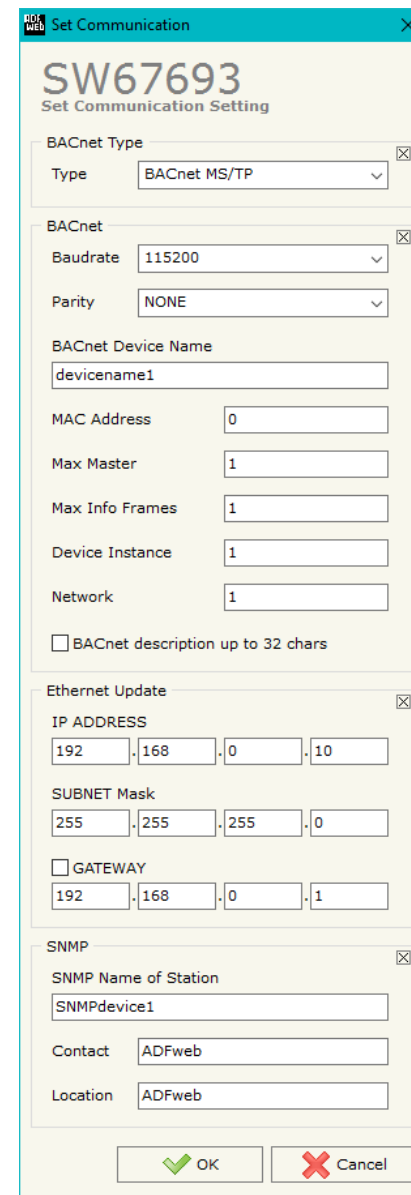

Figure 3b: "Set Communication" window

**SET BACNET ACCESS:**

By Pressing the “**Set BACnet Access**” button from the main window for SW676793 (Fig. 2) the window “BACnet Set Access” appears (Fig. 4).

The window is divided in two parts, the “BACnet in Read” that contains the BACnet objects readable by a BACnet Master (the SNMP data associated to these objects are written by a SNMP Manager); and “BACnet in Write” that contains the BACnet objects writeable by a BACnet Master (the SNMP data associated to these objects are readed by a SNMP Manager).

The meaning of the fields in the window are the follows:

- In the field “**Data Type**” the BACnet object data type is defined;
- In the field “**Eng. Unit**”, with double click the window “*Select the BACnet Engineering Unit*” appears (Fig. 5);
- In the field “**Position**” the byte of the internal arrays where taking/saving the data is defined;
- The field “**Start Bit**” is used for the Binary Objects in order to select the bit of the selected Position;
- In the field “**Length**” the dimension in byte of the Objects is defined (on “BACnet in Write” this field isn’t editable).

Notes:

The “BACnet in Write” object are also readable.

The “Mnemonic” field is readable like ‘Object\_Name’ and ‘Description’ property of BACnet variable.

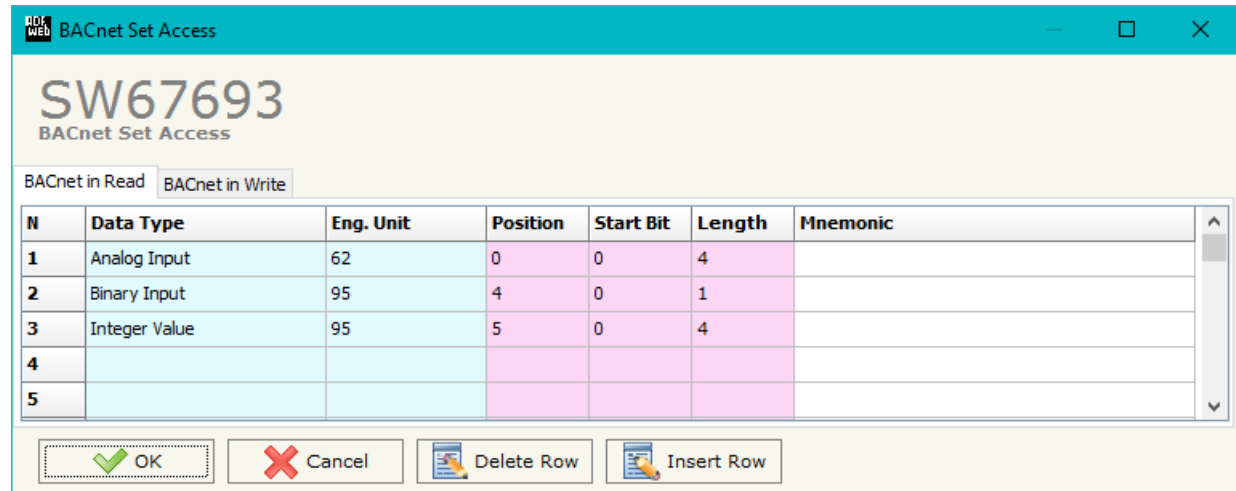
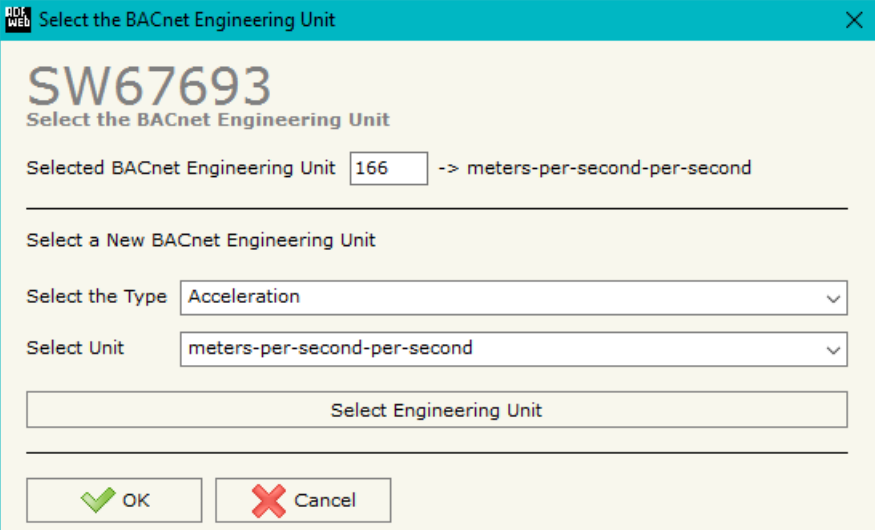

Figure 4: “BACnet Set Access” window



It is possible to insert directly the Unit (using its unique number) by compiling the **"Selected BACnet Engineering Unit"** field; or by selecting with the fields **"Select the Type"** and **"Select unit"** the Type/Unit desired. If the second way is used, it is necessary to press the **"Select Engineering Unit"** button for confirm the choice.



The screenshot shows a web-based dialog window titled "Select the BACnet Engineering Unit". At the top left, the ADFweb logo is visible. The main content area displays "SW67693" and "Select the BACnet Engineering Unit". Below this, there is a field for "Selected BACnet Engineering Unit" containing the value "166" and a unit indicator "meters-per-second-per-second". A horizontal line separates this from a section titled "Select a New BACnet Engineering Unit". This section contains two dropdown menus: "Select the Type" is set to "Acceleration" and "Select Unit" is set to "meters-per-second-per-second". Below these is a button labeled "Select Engineering Unit". At the bottom of the dialog are two buttons: "OK" with a green checkmark icon and "Cancel" with a red X icon.

Figure 5: "Select the BACnet Engineering Unit" window

### SET SNMP ACCESS:

By pressing the "Set SNMP Access" button from the main window for SW67693 (Fig. 2) the "Set SNMP Trap Access" window appears (Fig. 6). In this section, it is possible to create the OIDs for SNMP side to read or write using GET and SET commands or to be sent as TRAP messages. The window is divided into two tables, one for SNMP readings and one for SNMP writings.

The data of the columns in the "SNMP Read" have the following meanings:

- If the field "Enable" is checked, the SNMP OID is enabled;
- In the field "Community Name" the name of the Community is defined;
- In the field "Type" the type of data of the OID is defined (Octet String or Integer);
- If the field "On Change" is checked, the OID is sent as Trap when the data from BACnet side change;
- If the field "On CMD" is checked, the OID is sent as Trap when a new BACnet message is received;
- If the field "On Timer" is checked, the OID is sent as Trap cyclically;
- In the field "Time (ms)" the delay time for the Trap send is defined (if "On Timer" option is checked);
- In the field "Position" the starting byte of the internal memory array where taking the data is defined;
- In the field "Start Bit" the starting bit of the selected Position is defined;
- In the field "Num Bits/Bytes" the dimension of the OID is defined. For 'Int' type the dimension is in bit, for 'String' type the dimension is in bytes;
- In the field "Description" the description/name of the OID is defined;
- In the field "IP Address" the IP Address of the SNMP device where addressing the Trap message is defined. This field is used only when 'On Change' or 'On CMD' or 'On Timer' option is checked;
- In the field "Mnemonic" a brief description of the OID is defined.



Figure 6a: "Set SNMP Access -> SNMP Read" window

The data of the columns in the “SNMP Write” have the following meanings:

- If the field “**Enable**” is checked, the SNMP OID is enabled;
- In the field “**Community Name**” the name of the Community is defined;
- In the field “**Type**” the type of data of the OID is defined (Octet String or Integer);
- In the field “**Position**” the starting byte of the internal memory array where mapping the data is defined;
- In the field “**Start Bit**” the starting bit of the selected Position is defined;
- In the field “**Num Bits/Bytes**” the dimension of the OID is defined. For ‘Int’ type the dimension is in bit, for ‘String’ type the dimension is in bytes;
- In the field “**Description**” the description/name of the OID is defined;
- In the field “**Mnemonic**” a brief description of the OID is defined.

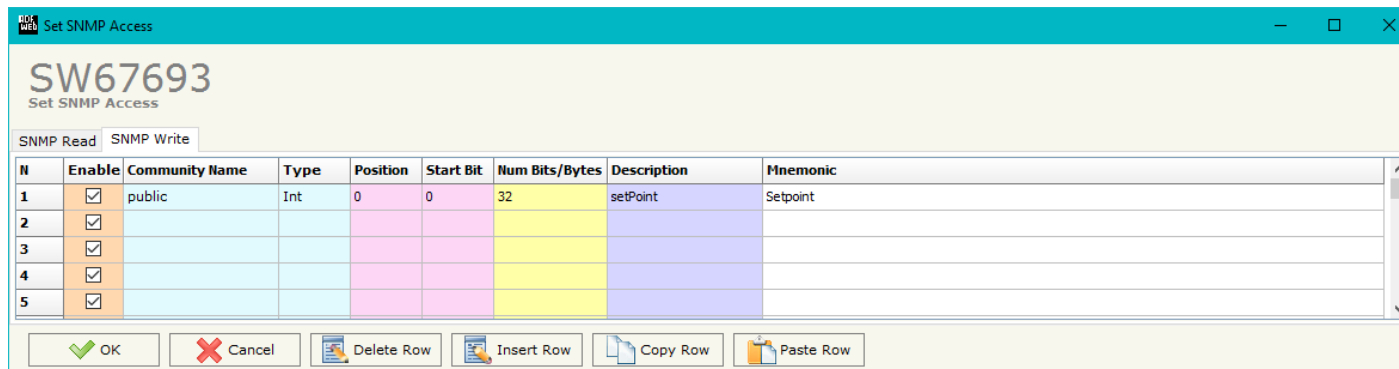

Figure 6b: “Set SNMP Access -> SNMP Write” window

**Note:** If the fields “On Change”, “On CMD” and “On Timer” are disabled, the OID is readable using standard GET command. If one of these fields is enabled, the OID is sent as Trap and it is readable by GET command too.

**Note:** The field “Description” must start with lowercase letter and it cannot contain special chars (just letters and numbers). All the “Description” fields must be different between them.

**OBJECTS MAP:**

By Pressing the "**Objects Map**" button from the main window for SW67693 (Fig. 2) is possible to create a .csv document with the map of BACnet Objects.

**SNMP MIB:**

By pressing the "**SNMP MIB**" button it is possible to save the MIB file for the SNMP Manager.

## UPDATE DEVICE:

By pressing the **"Update Device"** button, it is possible to load the created Configuration into the device; and also the Firmware, if necessary.

If you don't know the actual IP address of the device you have to use this procedure:

- Turn OFF the Device;
- Put Dip1 of 'Dip-Switch A' in ON position;
- Turn on the device
- Connect the Ethernet cable;
- Insert the IP **"192.168.2.205"**;
- Press the **"Ping"** button, "Device Found!" must appear;
- Press the **"Next"** button;
- Select which operations you want to do;
- Press the **"Execute update firmware"** button to start the upload;
- When all the operations are "OK" turn off the Device;
- Put Dip1 of 'Dip-Switch A' at OFF position;
- Turn ON the device.

If you know the actual IP address of the device, you have to use this procedure:

- Turn on the Device with the Ethernet cable inserted;
- Insert the actual IP of the Converter;
- Press the **"Ping"** button, must appear "Device Found!";
- Press the **"Next"** button;
- Select which operations you want to do;
- Press the **"Execute update firmware"** button to start the upload;
- When all the operations are "OK" the device automatically goes at Normal Mode.

At this point the configuration/firmware on the device is correctly update.

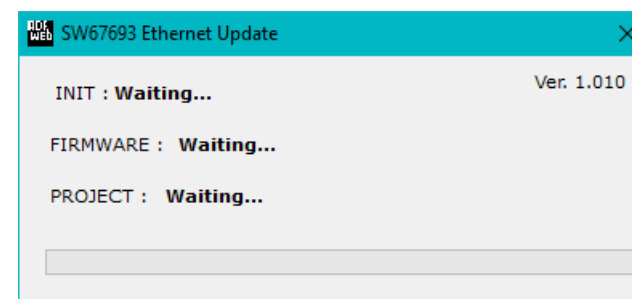
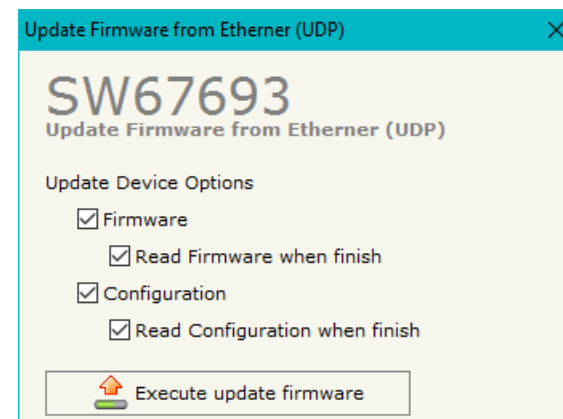
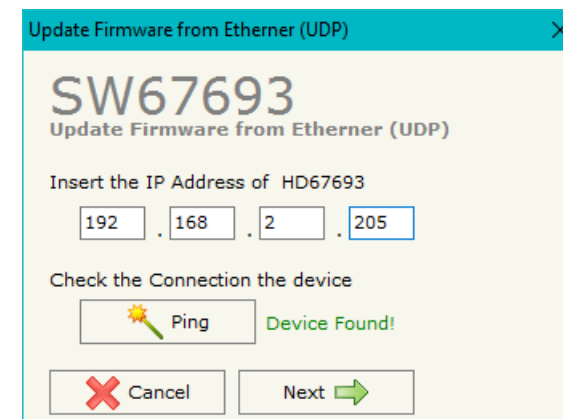

Figure 7: "Update device" windows

**Note:**

When you install a new version of the software, if it is the first time it is better you do the update of the Firmware in the HD67693 device.

**Note:**

When you receive the device, for the first time, you also have to update the Firmware in the HD67693 device.

**Warning:**

If Fig. 8 appears when you try to do the Update try these points before seeking assistance:

- Try to repeat the operations for the updating;
- Try with another PC;
- Try to restart the PC;
- Check the LAN settings;
- If you are using the program inside a Virtual Machine, try to use in the main Operating System;
- If you are using Windows Seven, Vista, 8 or 10 make sure that you have the administrator privileges;
- In case you have to program more than one device, using the "UDP Update", you have to cancel the ARP table every time you connect a new device on Ethernet. For do this you have to launch the "Command Prompt" and write the command "arp -d". Pay attention that with Windows Vista, Seven, 8 or 10 you have to launch the "Command Prompt" with Administrator Rights;
- Pay attention at Firewall lock.

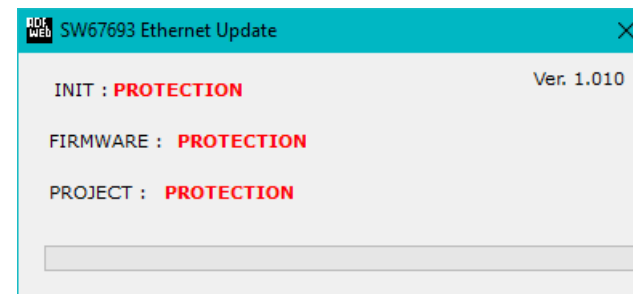

Figure 8: "Protection" window administrator privileges;



In the case of HD67693 you have to use the software "SW67693": [www.adfweb.com/download/filefold/SW67693.zip](http://www.adfweb.com/download/filefold/SW67693.zip).

## SNMP COMMUNICATION

In order to read/write the data from/to BACnet side, it is necessary to use specific SNMP commands in order to see the SNMP Input and write the SNMP Output.

### Reading BACnet data from SNMP:

In order to read the data from the HD67693, it is necessary to use the GET command.  
Each OID defined in the section "Set SNMP Access -> SNMP Read" will be placed in the MIB tree of the converter.

In addition, it will be possible to read the entire internal map of the converter in memory blocks of 128 bytes: this feature is helpful in phase of configuration of the converter.

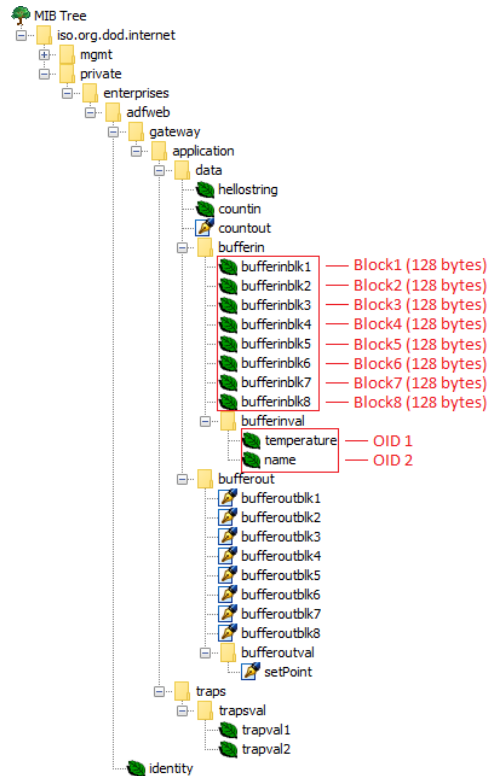



Each SNMP variable created will have its own OID and it will be created following this rule:

- OID 1 (first row of "Set SNMP Access -> SNMP Read" table): **.1.3.6.1.4.1.49314.1.1.1.4.9.1**
- OID 2 (second row of "Set SNMP Access -> SNMP Read" table): **.1.3.6.1.4.1.49314.1.1.1.4.9.2**
- OID X (Xth row of "Set SNMP Access -> SNMP Read" table): **.1.3.6.1.4.1.49314.1.1.1.4.9.X**

The memory blocks are accessible with these OIDs:

- Block1: **.1.3.6.1.4.1.49314.1.1.1.4.1.0**
- Block2: **.1.3.6.1.4.1.49314.1.1.1.4.2.0**
- Block3: **.1.3.6.1.4.1.49314.1.1.1.4.3.0**
- Block4: **.1.3.6.1.4.1.49314.1.1.1.4.4.0**
- Block5: **.1.3.6.1.4.1.49314.1.1.1.4.5.0**
- Block6: **.1.3.6.1.4.1.49314.1.1.1.4.6.0**
- Block7: **.1.3.6.1.4.1.49314.1.1.1.4.7.0**
- Block8: **.1.3.6.1.4.1.49314.1.1.1.4.8.0**

Writing BACnet data from SNMP:

In order to write the data from the HD67693, it is necessary to use the SET command.

Each OID defined in the section "Set SNMP Access -> SNMP Write" will be placed in the MIB tree of the converter.

In addition, it will be possible to write the entire internal map of the converter in memory blocks of 128 bytes: this feature is helpful in phase of configuration of the converter.

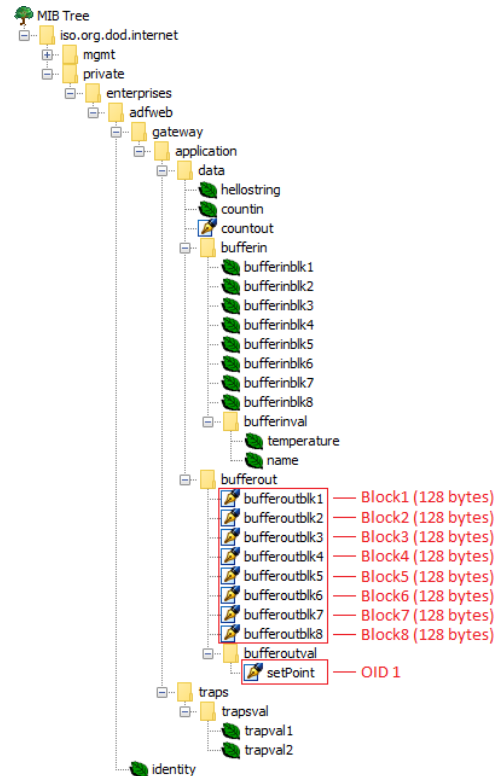

Each SNMP variable created will have its own OID and it will be created following this rule:

- ➔ OID 1 (first row of "Set SNMP Access -> SNMP Write" table): **.1.3.6.1.4.1.49314.1.1.1.5.9.1**
- ➔ OID 2 (second row of "Set SNMP Access -> SNMP Write" table): **.1.3.6.1.4.1.49314.1.1.1.5.9.2**
- ➔ OID X (Xth row of "Set SNMP Access -> SNMP Write" table): **.1.3.6.1.4.1.49314.1.1.1.5.9.X**

The memory blocks are accessible with these OIDs:

- ➔ Block1: .1.3.6.1.4.1.49314.1.1.1.5.1.0
- ➔ Block2: .1.3.6.1.4.1.49314.1.1.1.5.2.0
- ➔ Block3: .1.3.6.1.4.1.49314.1.1.1.5.3.0
- ➔ Block4: .1.3.6.1.4.1.49314.1.1.1.5.4.0
- ➔ Block5: .1.3.6.1.4.1.49314.1.1.1.5.5.0
- ➔ Block6: .1.3.6.1.4.1.49314.1.1.1.5.6.0
- ➔ Block7: .1.3.6.1.4.1.49314.1.1.1.5.7.0
- ➔ Block8: .1.3.6.1.4.1.49314.1.1.1.5.8.0



**Note:**

The OIDs in writing are readable too with GET command.

TRAP messages from SNMP:

All the OIDs defined in the "Set SNMP Access -> SNMP Read" table can be sent as TRAP messages too.

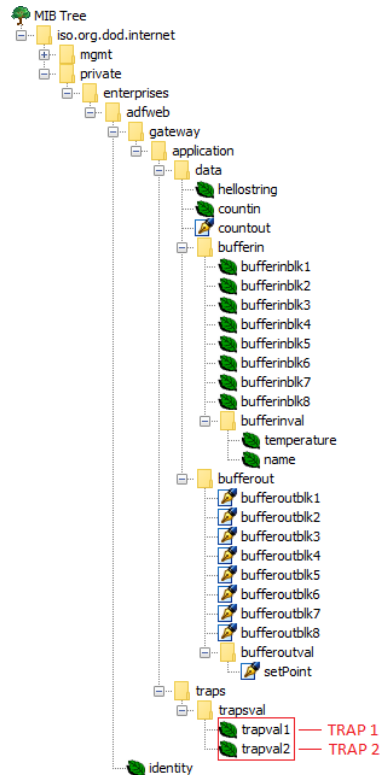

The TRAP messages are contained in the MIB tree and they have these OIDs:

- TRAP 1 (first row of "Set SNMP Access -> SNMP Read" table): .1.3.6.1.4.1.49314.1.1.2.1.1
- TRAP 2 (second row of "Set SNMP Access -> SNMP Read" table): .1.3.6.1.4.1.49314.1.1.2.1.2
- TRAP X (Xth row of "Set SNMP Access -> SNMP Read" table): .1.3.6.1.4.1.49314.1.1.2.1.X

**MECHANICAL DIMENSIONS:**

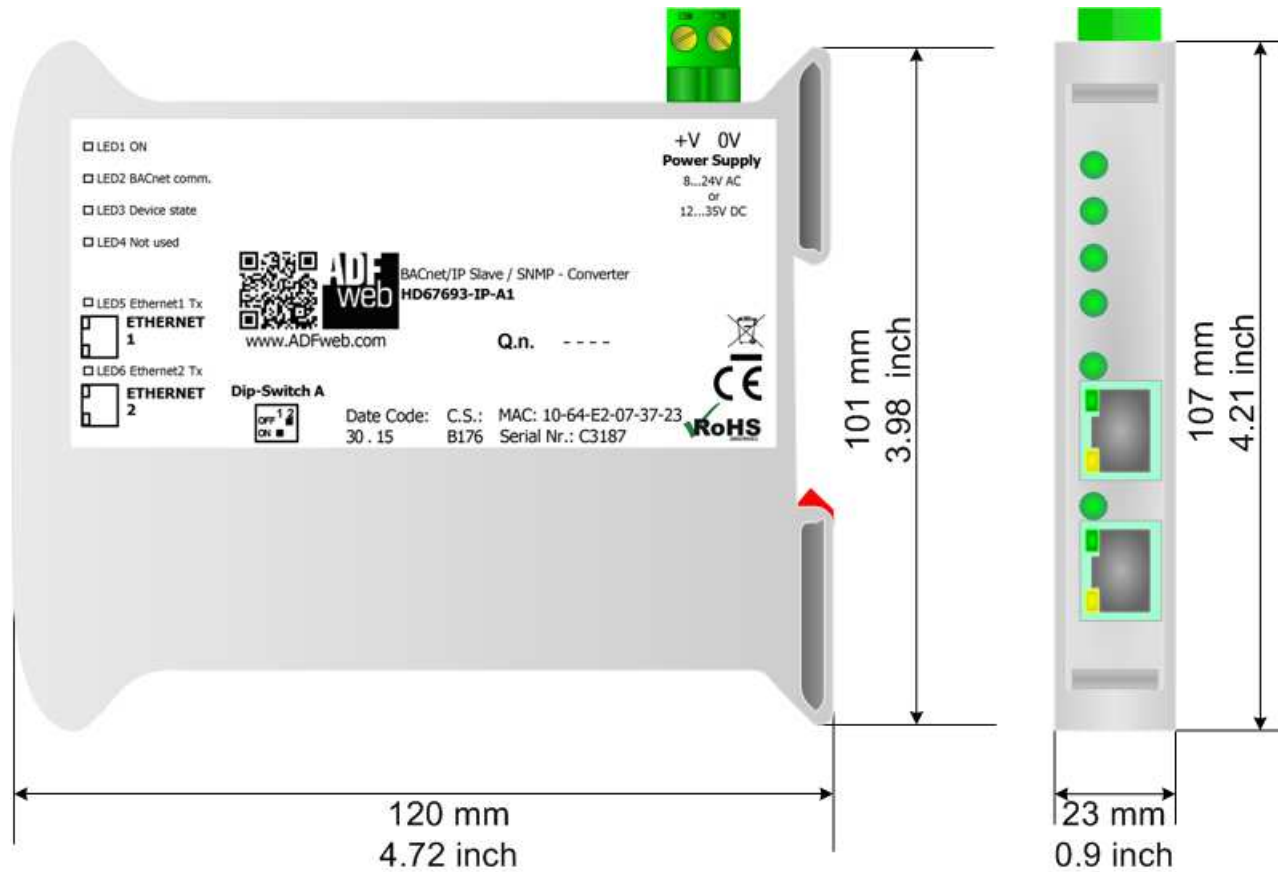

Housing: PVC  
Weight: 200g (Approx)

Figure 9a: Mechanical dimensions scheme for HD67693-IP-A1

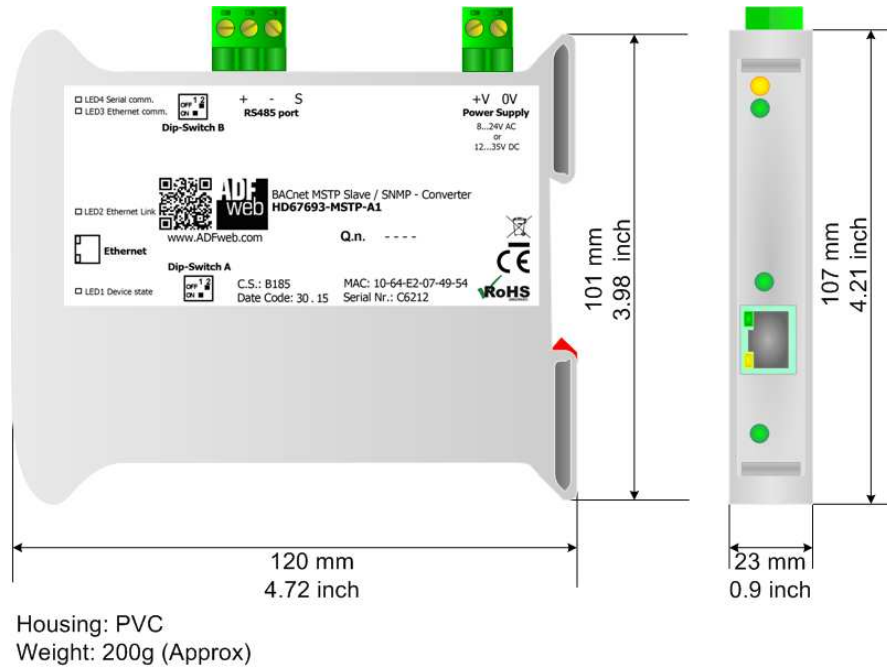

Figure 9b: Mechanical dimensions scheme for HD67693-MSTP-A1

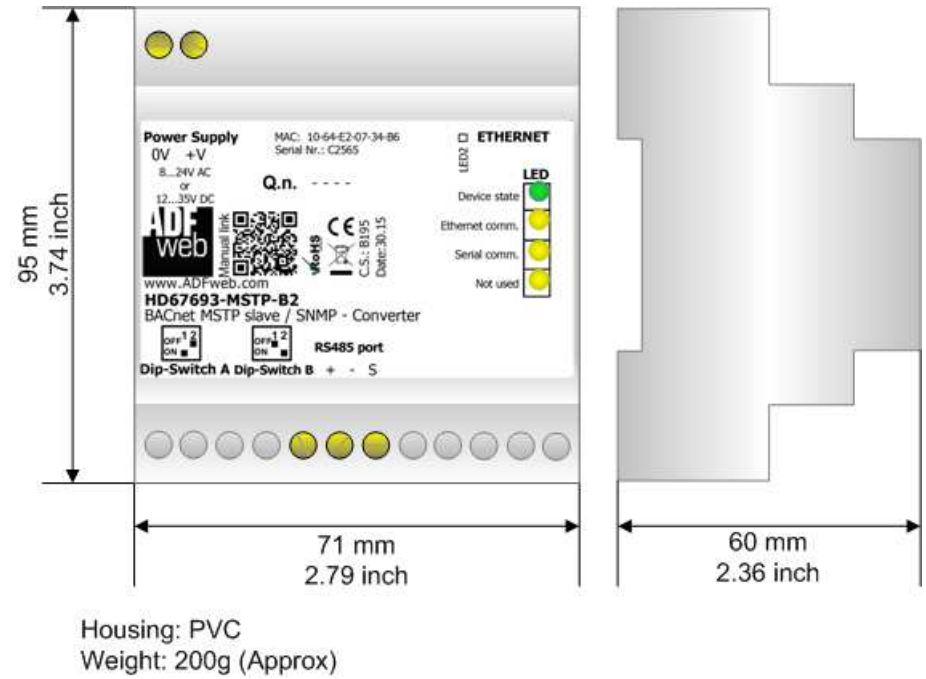
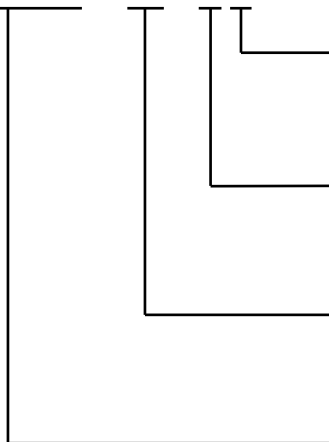

Figure 9c: Mechanical dimensions scheme for HD67693-MSTP-B2

**ORDERING INFORMATIONS:**

The ordering part number is formed by a valid combination of the following:

**HD67693 - xxx - xx**



**Connectors Type**

- 1: Removable 5mm Screw Terminal
- 2: Fixed 5mm Screw Terminal

**Enclosure Type**

- A: 1M, 35mm DIN Rail mounting
- B: 4M, 35mm DIN Rail mounting

**BACnet type**

- IP: BACnet/IP
- MSTP: BACnet MS/TP

**Device Family**

HD67693: BACnet slave / SNMP Agent - Converter

- Order Code: **HD67693-IP-A1** - BACnet/IP slave / SNMP Agent - Converter
- Order Code: **HD67693-MSTP-A1** - BACnet MS/TP slave / SNMP Agent - Converter
- Order Code: **HD67693-MSTP-B2** - BACnet MS/TP slave / SNMP Agent - Converter

**ACCESSORIES:**

- Order Code: **AC34001** - 35mm Rail DIN - Power Supply 220/240V AC 50/60Hz - 12 V AC
- Order Code: **AC34002** - 35mm Rail DIN - Power Supply 110V AC 50/60Hz - 12 V AC

**DISCLAIMER:**

All technical content within this document can be modified without notice. The content of the document is a under continual renewal. For losses due to fire, earthquake, third party access or other accidents, or intentional or accidental abuse, misuse, or use under abnormal conditions repairs are charged to the user. ADFweb.com S.r.l. will not be liable for accidental loss of use or inability to use this product, such as loss of business income. ADFweb.com S.r.l. shall not be liable for consequences of improper use.

**OTHER REGULATIONS AND STANDARDS:****WEEE INFORMATION**

Disposal of old electrical and electronic equipment (as in the European Union and other European countries with separate collection systems).

— This symbol on the product or on its packaging indicates that this product may not be treated as household rubbish. Instead, it should be taken to an applicable collection point for the recycling of electrical and electronic equipment. If the product is disposed correctly, you will help prevent potential negative environmental factors and impact of human health, which could otherwise be caused by inappropriate disposal. The recycling of materials will help to conserve natural resources. For more information about recycling this product, please contact your local city office, your household waste disposal service or the shop where you purchased the product.

**RESTRICTION OF HAZARDOUS SUBSTANCES DIRECTIVE**

The device respects the 2002/95/EC Directive on the restriction of the use of certain hazardous substances in electrical and electronic equipment (commonly referred to as Restriction of Hazardous Substances Directive or RoHS).

**CE MARKING**

The product conforms with the essential requirements of the applicable EC directives.



**WARRANTIES AND TECHNICAL SUPPORT:**

For fast and easy technical support for your ADFweb.com SRL products, consult our internet support at [www.adfweb.com](http://www.adfweb.com). Otherwise contact us at the address [support@adfweb.com](mailto:support@adfweb.com)

**RETURN POLICY:**

If while using your product you have any problem and you wish to exchange or repair it, please do the following:

- Obtain a Product Return Number (PRN) from our internet support at [www.adfweb.com](http://www.adfweb.com). Together with the request, you need to provide detailed information about the problem.
- Send the product to the address provided with the PRN, having prepaid the shipping costs (shipment costs billed to us will not be accepted).

If the product is within the warranty of twelve months, it will be repaired or exchanged and returned within three weeks. If the product is no longer under warranty, you will receive a repair estimate.



**ADFweb.com S.r.l.**  
Via Strada Nuova, 17  
IT-31010 Mareno di Piave  
TREVISO (Italy)  
Phone +39.0438.30.91.31  
Fax +39.0438.49.20.99  
[www.adfweb.com](http://www.adfweb.com)

