

## User Manual

Revision 1.100  
English

### CAN / CANopen - Converter

(Order Code: HD67042-A1, HD67042-A3, HD67042-A4)

for Website information:

[www.adfweb.com?Product=HD67042](http://www.adfweb.com?Product=HD67042)

for Price information:

[www.adfweb.com?Price=HD67042-A1](http://www.adfweb.com?Price=HD67042-A1)

[www.adfweb.com?Price=HD67042-A3](http://www.adfweb.com?Price=HD67042-A3)

[www.adfweb.com?Price=HD67042-A4](http://www.adfweb.com?Price=HD67042-A4)

#### Benefits and Main Features:

- ✦ Very easy to configure
- ✦ Electrical isolation
- ✦ Temperature range: -40°C/85°C (-40°F/185°F)



For others Gateways / Bridges:

#### J1939 to Modbus

See also the following links:

[www.adfweb.com?Product=HD67215](http://www.adfweb.com?Product=HD67215) (Modbus TCP)

#### CANopen to Modbus

See also the following links:

[www.adfweb.com?Product=HD67001](http://www.adfweb.com?Product=HD67001) (Modbus RTU Master)

[www.adfweb.com?Product=HD67002](http://www.adfweb.com?Product=HD67002) (Modbus RTU Slave)

[www.adfweb.com?Product=HD67004](http://www.adfweb.com?Product=HD67004) (Modbus TCP Master)

[www.adfweb.com?Product=HD67005](http://www.adfweb.com?Product=HD67005) (Modbus TCP Slave)

For others Gateways / Bridges:

For **CAN bus 2.0A** and/or **CAN bus 2.0B** to **Modbus**

See also the following links:

[www.adfweb.com?Product=HD67011](http://www.adfweb.com?Product=HD67011) (Modbus RTU Slave)

[www.adfweb.com?Product=HD67012](http://www.adfweb.com?Product=HD67012) (Modbus RTU Master)

[www.adfweb.com?Product=HD67014](http://www.adfweb.com?Product=HD67014) (Modbus TCP Slave)

[www.adfweb.com?Product=HD67015](http://www.adfweb.com?Product=HD67015) (Modbus TCP Master)

Do you have an your customer protocol?

See the following links:

[www.adfweb.com?Product=HD67003](http://www.adfweb.com?Product=HD67003)

Do you need to choose a device? do you want help?

Ask it to the following link:

[www.adfweb.com?Cmd=helpme](http://www.adfweb.com?Cmd=helpme)



User Manual

**INDEX:**

	Page
INDEX	2
UPDATED DOCUMENTATION	2
REVISION LIST	2
WARNING	2
TRADEMARKS	2
SECURITY ALERT	3
CONNECTION SCHEME	4
CHARACTERISTICS	7
CONFIGURATION	7
POWER SUPPLY	8
FUNCTION MODES	9
LEDS	10
CANOPEN	11
CAN	12
ETHERNET	13
USE OF COMPOSITOR SW67042	14
NEW PROJECT / OPEN PROJECT	15
SOFTWARE OPTIONS	16
SET COMMUNICATION	18
RECEIVE CAN	20
DEFINE SDO (STEP 3)	22
DEFINE TPDO	23
TRANSMIT CAN	25
DEFINE SDO (STEP 4)	27
DEFINE RPDO	28
SET SDO CLIENT	30
SET NODEGUARDING	32
EDS FILE	32
UPDATE DEVICE	33
NMT REQUESTS	36
MECHANICAL DIMENSIONS	37
ORDER CODE	38
ACCESSORIES	38
DISCLAIMER	39
OTHER REGULATIONS AND STANDARDS	39
WARRANTIES AND TECHNICAL SUPPORT	40
RETURN POLICY	40

**UPDATED DOCUMENTATION:**

Dear customer, we thank you for your attention and we remind you that you need to check that the following document is:

- ✚ Updated
- ✚ Related to the product you own

To obtain the most recently updated document, note the “document code” that appears at the top right-hand corner of each page of this document.

With this “Document Code” go to web page [www.adfweb.com/download/](http://www.adfweb.com/download/) and search for the corresponding code on the page. Click on the proper “Document Code” and download the updates.

**REVISION LIST:**

Revision	Date	Author	Chapter	Description
1.004	11/07/2012	Dp	All	Revision
1.005	26/03/2013	Nt	All	Added new chapters
1.006	05/11/2013	Dp	All	Revision
1.100	15/11/2015	Ff	All	New hardware version

**WARNING:**

ADFweb.com reserves the right to change information in this manual about our product without warning. ADFweb.com is not responsible for any error this manual may contain.

**TRADEMARKS:**

All trademarks mentioned in this document belong to their respective owners.

**SECURITY ALERT:****GENERAL INFORMATION**

To ensure safe operation, the device must be operated according to the instructions in the manual. When using the device, legal and safety regulation are required for each individual application. The same applies also when using accessories.

**INTENDED USE**

Machines and systems must be designed so the faulty conditions do not lead to a dangerous situation for the operator (i.e. independent limit switches, mechanical interlocks, etc.).

**QUALIFIED PERSONNEL**

The device can be used only by qualified personnel, strictly in accordance with the specifications. Qualified personnel are persons who are familiar with the installation, assembly, commissioning and operation of this equipment and who have appropriate qualifications for their job.

**RESIDUAL RISKS**

The device is state-of-the-art and is safe. The instruments can represent a potential hazard if they are inappropriately installed and operated by untrained personnel. These instructions refer to residual risks with the following symbol:



This symbol indicates that non-observance of the safety instructions is a danger for people that could lead to serious injury or death and / or the possibility of damage.

**CE CONFORMITY**

The declaration is made by our company. You can send an email to [support@adfweb.com](mailto:support@adfweb.com) or give us a call if you need it.

**CONNECTION SCHEME:**

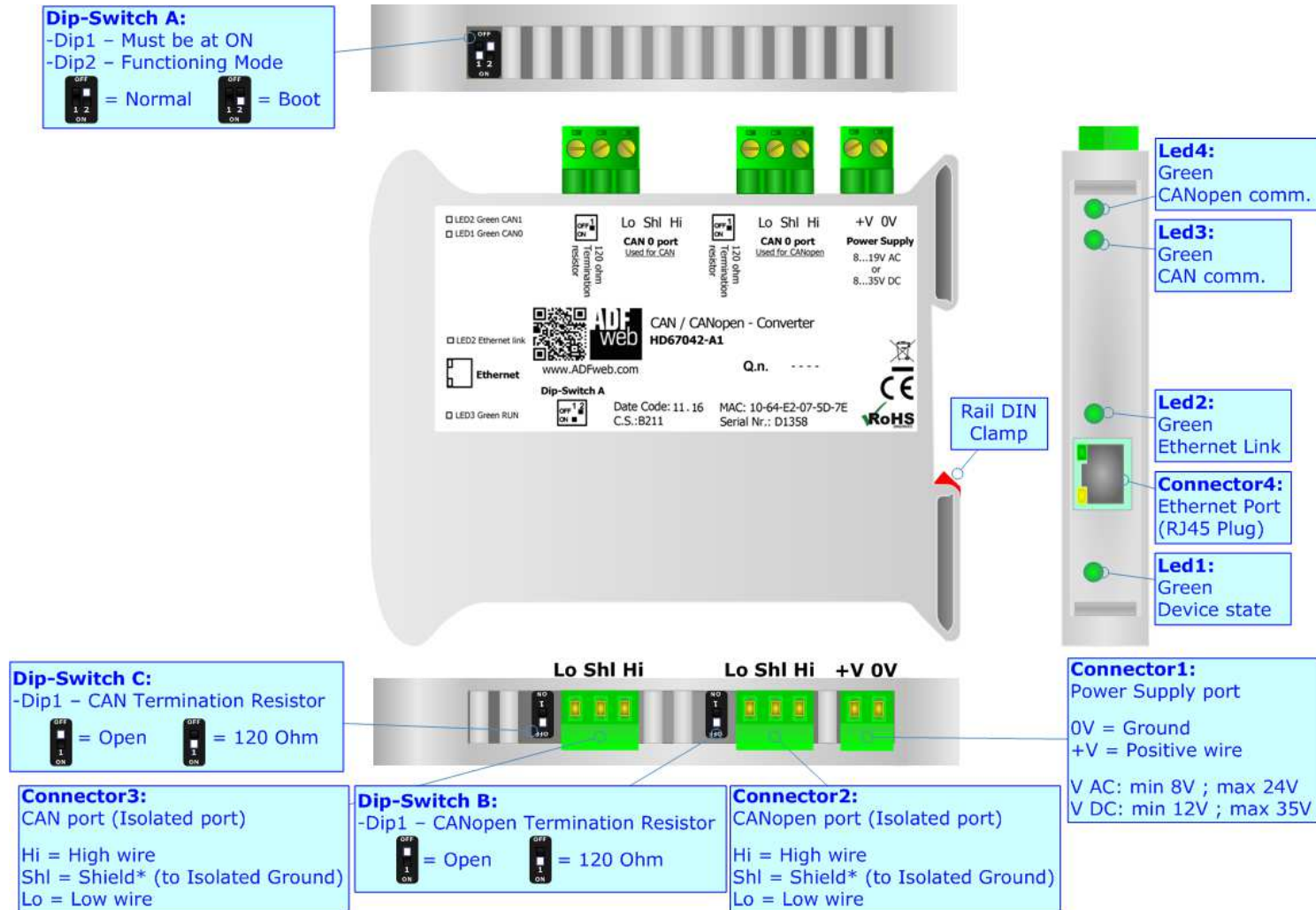

Figure 1a: Connection scheme for HD67042-A1

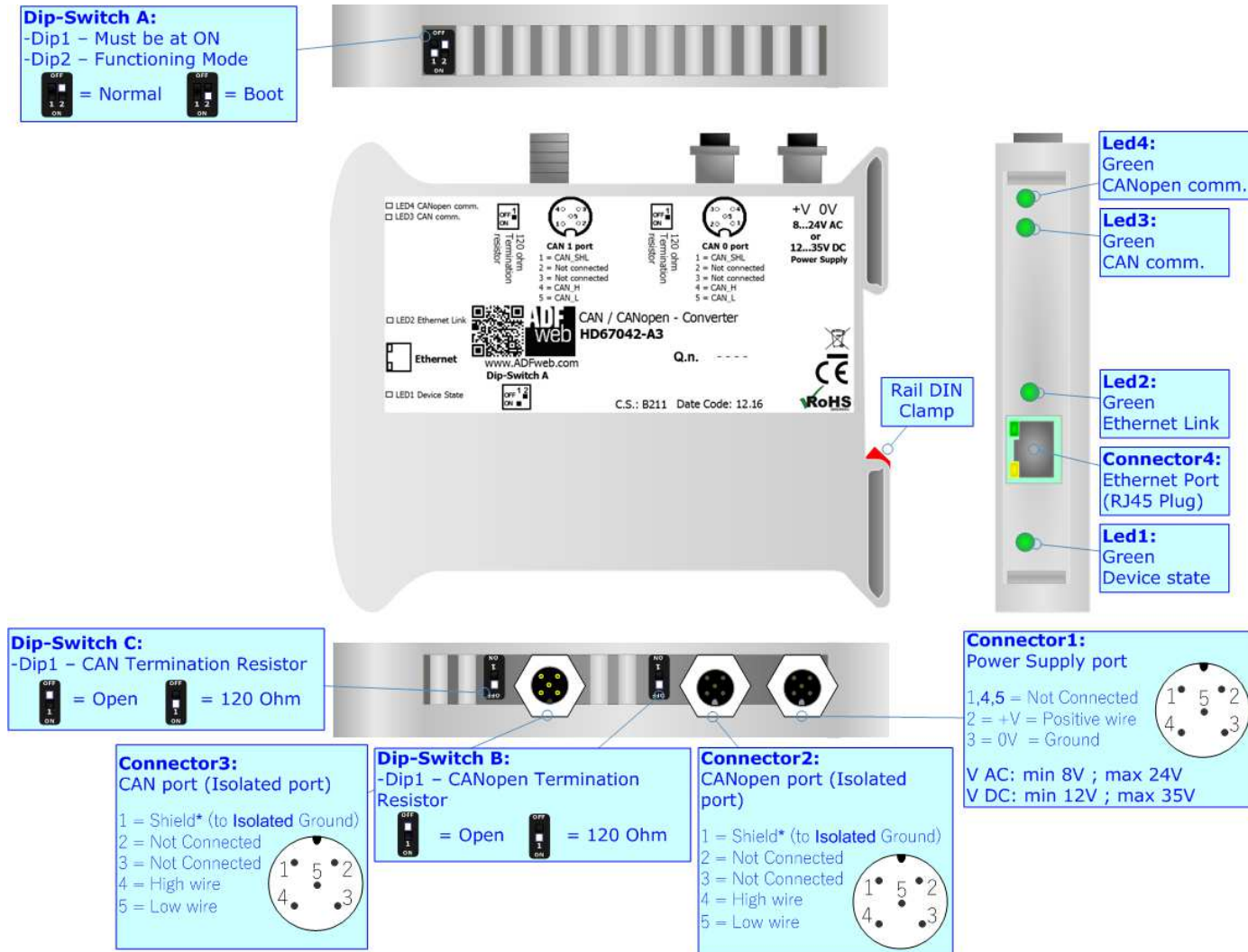

Figure 1b: Connection scheme for HD67042-A3

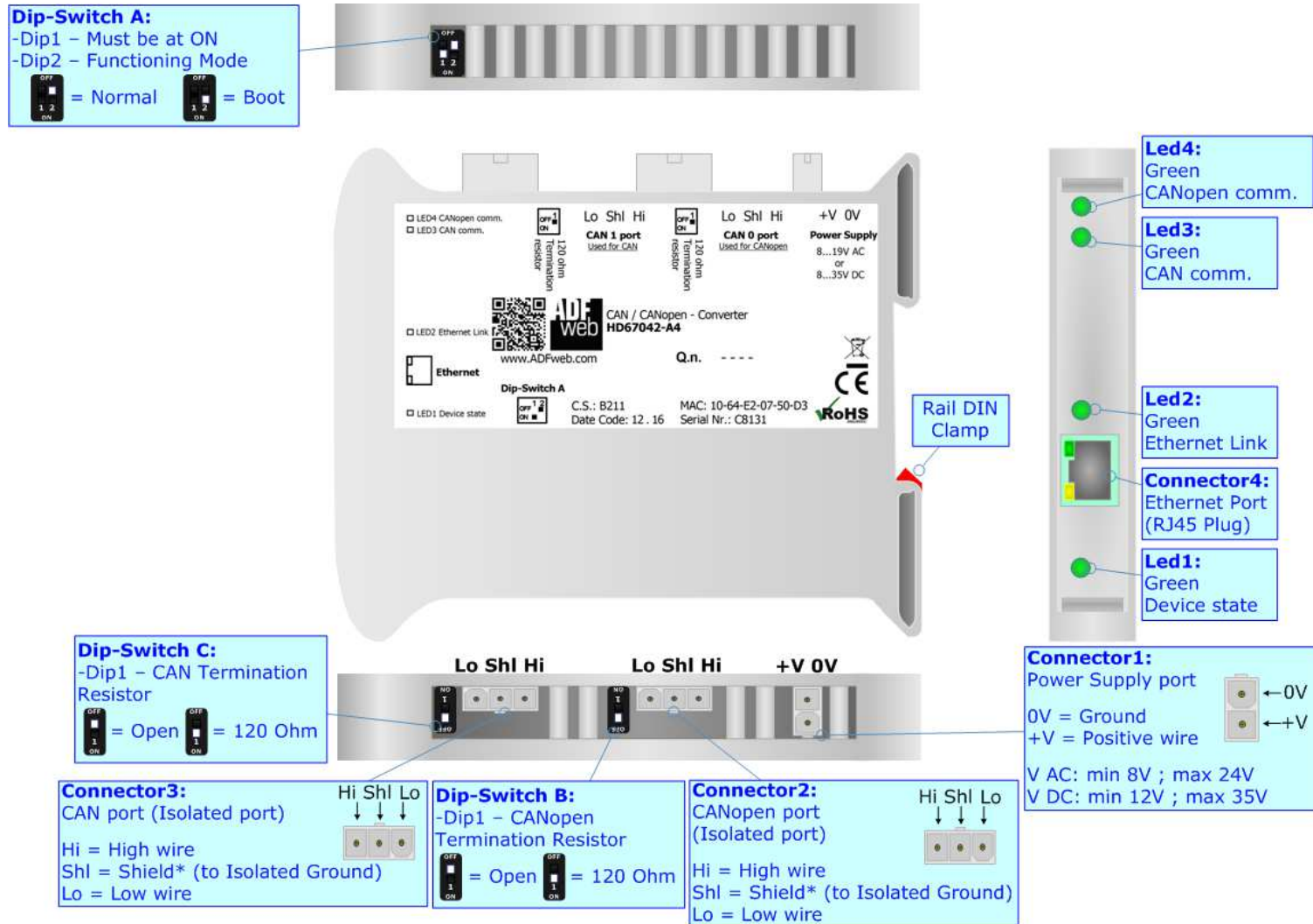

Figure 1c: Connection scheme for HD67042-A4



**CHARACTERISTICS:**

The HD67042 is a CAN / CANopen Converter.

They have the following characteristics:

- Triple isolation between CAN - Power Supply, CAN - CANopen, CANopen - Power Supply;
- Two-directional information between CANopen bus and CAN bus;
- Mountable on 35mm Rail DIN;
- Wide power supply input range: 8...24V AC or 12...35V DC;
- Wide temperature range: -40°C / 85°C [-40°F / +185°F].

**CONFIGURATION:**

You need Compositor SW67042 software on your PC in order to perform the following:

- Define the parameters of CAN line;
- Define the parameters of CANopen line;
- Define the CAN messages in reception and in which CANopen objects they will be mapped;
- Define the CAN messages in transmission and from which CANopen objects they will be taken;
- Update the device.

**POWER SUPPLY:**

The devices can be powered at 8...24V AC and 12...35V DC. For more details see the two tables below.

VAC		VDC	
Vmin	Vmax	Vmin	Vmax
8V	24V	12V	35V

Consumption at 24V DC:

Device	Consumption [W/VA]
HD67042-A1	3.5
HD67042-A3	3.5
HD67042-A4	3.5

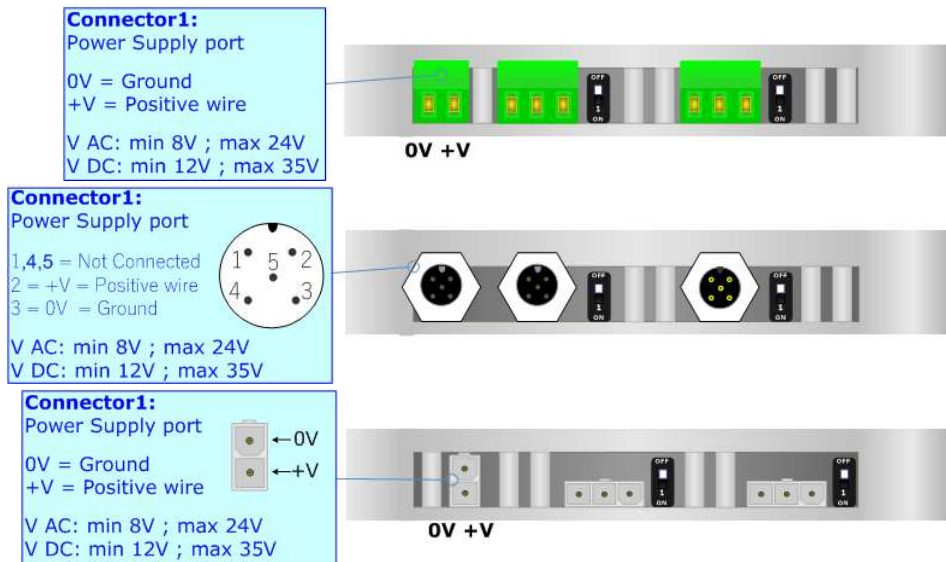

**Caution: Do not reverse the polarity power**

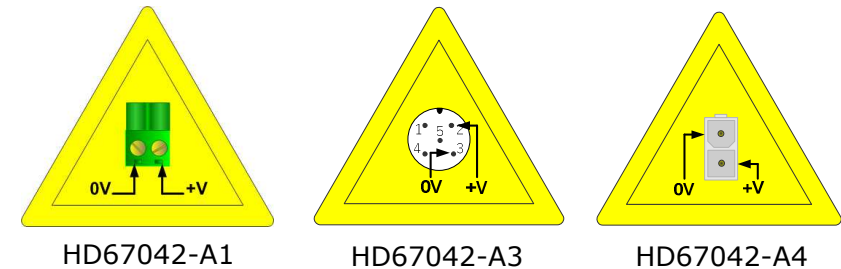



**FUNCTION MODES:**

The device has got two function modes depending on the position of the 'Dip2 of Dip-Switch A':

- The first, with 'Dip2 of Dip-Switch A' at "OFF" position, is used for the normal working of the device.
- The second, with 'Dip2 of Dip-Switch A' at "ON" position, is used for uploading the Project and/or Firmware.

For the operations to follow for the updating, see 'UPDATE DEVICE' section.

According to the functioning mode, the LEDs will have specific functions, see 'LEDS' section.

**Warning:**

Dip1 of 'Dip-Switch A' must be at ON position to work even if the Ethernet cable is not inserted.

**LEDS:**

The device has got four LEDs that are used to give information about the functioning status. The various meanings of the LEDs are described in the table below.

LED	Normal Mode	Boot Mode
1: Device state	Blinks slowly (~1Hz)	<b>Blinks quickly:</b> Boot state <b>Blinks very slowly (~0.5Hz):</b> update in progress
2: Ethernet Link	<b>ON:</b> Ethernet cable connected <b>OFF:</b> Ethernet cable disconnected	<b>ON:</b> Ethernet cable connected <b>OFF:</b> Ethernet cable disconnected
3: CAN communication	Blinks when a CAN frame is received	<b>Blinks quickly:</b> Boot state <b>Blinks very slowly (~0.5Hz):</b> update in progress
4: CANopen communication	Blinks when a CANopen frame is received	<b>Blinks quickly:</b> Boot state <b>Blinks very slowly (~0.5Hz):</b> update in progress

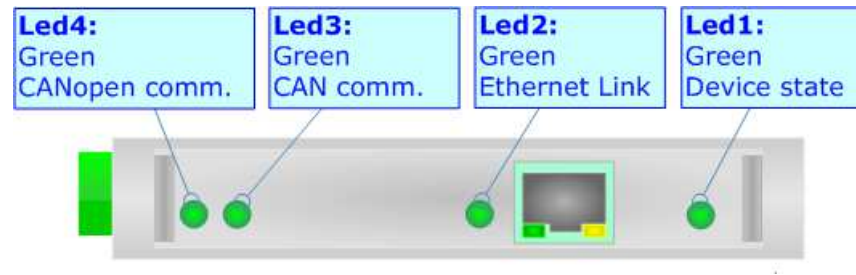

**CANOPEN:**

To terminate the CANopen line with a 120Ω resistor it is necessary that the Dip1 of 'Dip-Switch B' is at ON position.

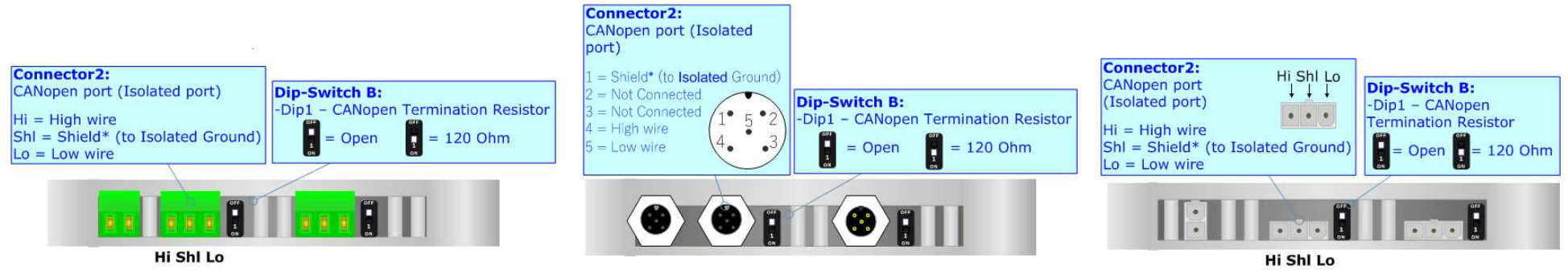

Cable characteristics:

<b>DC parameter:</b>	Impedance	70 Ohm/m
<b>AC parameters:</b>	Impedance	120 Ohm/m
	Delay	5 ns/m
<b>Length</b>	<b>Baud Rate [bps]</b>	<b>Length MAX [m]</b>
	10 K	5000
	20 K	2500
	50 K	1000
	100 K	650
	125 K	500
	250 K	250
	500 K	100
	800 K	50
	1000 K	25

Here some codes of cable:

- Belden: p/n 3105A - 1x 22WG stranded twisted pairs conductor + foil shield + braid shield.

**CAN:**

To terminate the CAN line with a 120Ω resistor it is necessary that the Dip1 of 'Dip-Switch C' is at ON position.

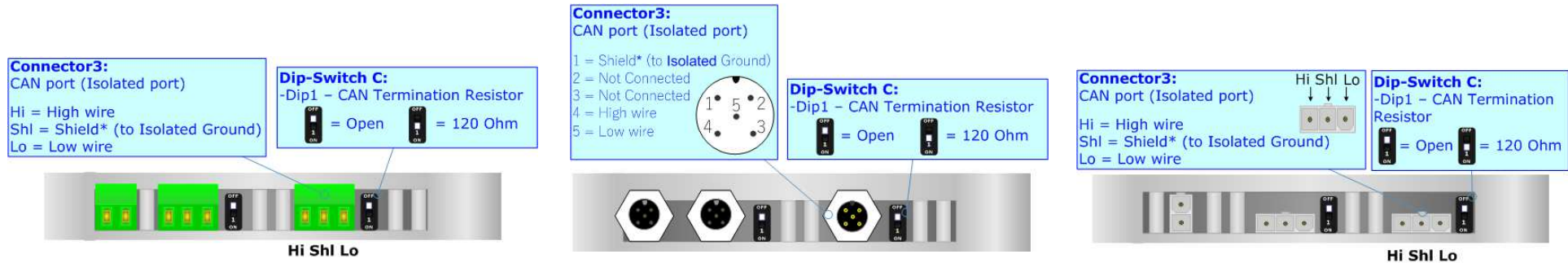

Cable characteristics:

<b>DC parameter:</b>	Impedance	70 Ohm/m
<b>AC parameters:</b>	Impedance	120 Ohm/m
	Delay	5 ns/m
<b>Length</b>	<b>Baud Rate [bps]</b>	<b>Length MAX [m]</b>
	10 K	5000
	20 K	2500
	50 K	1000
	100 K	650
	125 K	500
	250 K	250
	500 K	100
	800 K	50
	1000 K	25

Here some codes of cable:

- Belden: p/n 3105A - 1x 22WG stranded twisted pairs conductor + foil shield + braid shield.

**ETHERNET:**

The Ethernet connection must be made using Connector4 HD67042 with at least a Category 5E cable. The maximum length of the cable should not exceed 100m. The cable has to conform to the T568 norms relative to connections in cat.5 up to 100 Mbps. To connect the device to an Hub/Switch is recommended the use of a straight cable, to connect the device to a PC is recommended the use of a cross cable.



## USE OF COMPOSITOR SW67042:

To configure the Converter, use the available software that runs with Windows called SW67042. It is downloadable from the site [www.adfweb.com](http://www.adfweb.com) and its operation is described in this document (*this manual is referenced to the last version of the software present on our web site*). The software works with MSWindows (XP, Vista, Seven, 8, 10; 32/64bit).

When launching the SW67042, the window below appears (Fig. 2).



**Note:**

It is necessary to have installed .Net Framework 4.

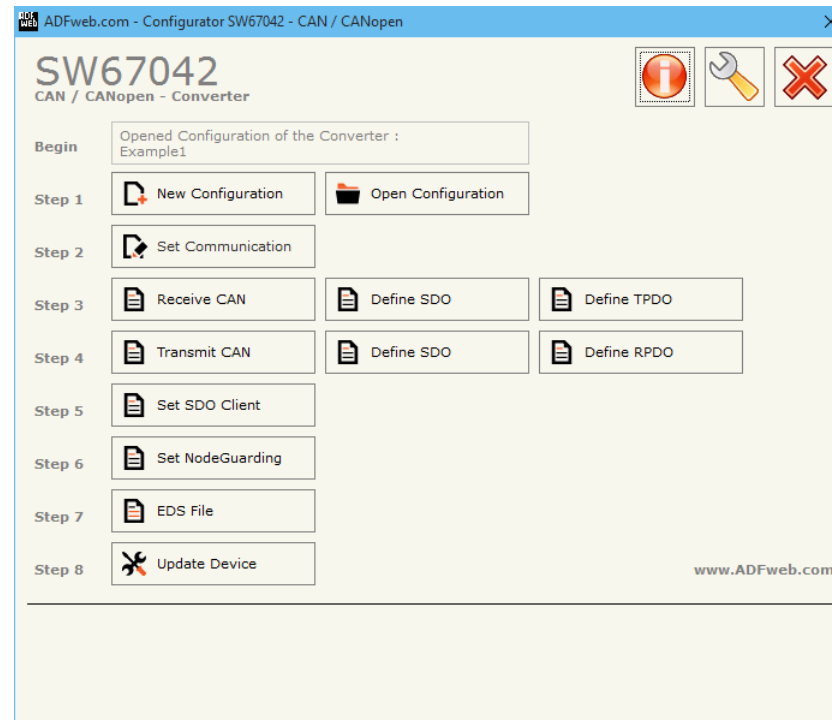
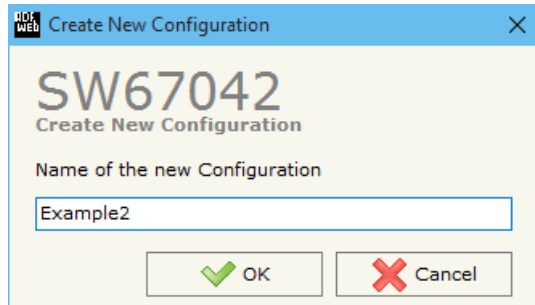

Figure 2: Main window for SW67042



**NEW CONFIGURATION / OPEN CONFIGURATION:**

The “**New Configuration**” button creates the folder which contains the entire device’s configuration.



A device’s configuration can also be imported or exported:

- To clone the configurations of a Programmable “CAN / CANopen - Converter” in order to configure another device in the same manner, it is necessary to maintain the folder and all its contents;
- To clone a project in order to obtain a different version of the project, it is sufficient to duplicate the project folder with another name and open the new folder with the button “**Open Configuration**”.

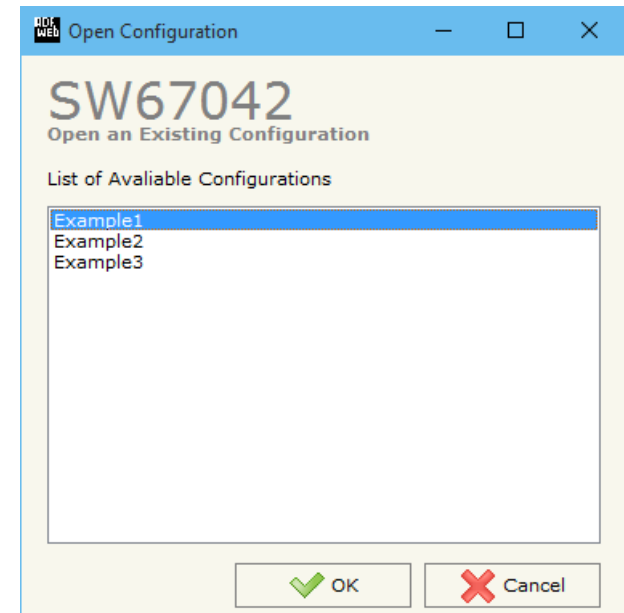

**SOFTWARE OPTIONS:**

By pressing the “**Settings**” () button there is the possibility to change the language of the software and check the updatings for the compositor.

In the section “Language” it is possible to change the language of the software.

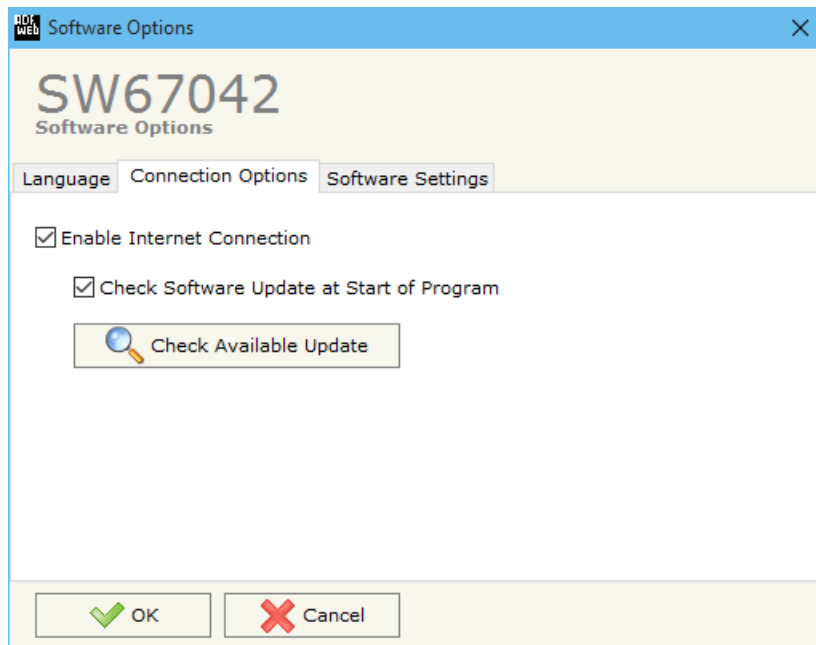

In the section “Connection Options”, it is possible to check if there are some updatings of the software compositor in ADFweb.com website. Checking the option “**Check Software Update at Start of Program**”, the SW67042 check automatically if there are updatings when it is launched.

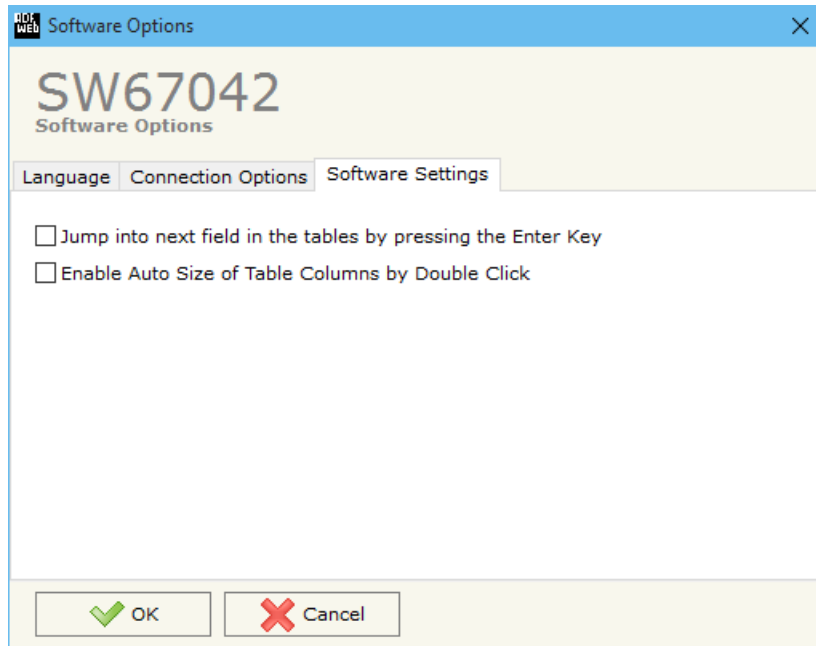

In the section "Software Settings", it is possible to enable/disable some keyboard's commands for an easier navigation inside the tables contained in the different sections of the software.

**SET COMMUNICATION:**

This section define the fundamental communication parameters of two buses, CAN and CANopen.

By Pressing the **“Set Communication”** button from the main window for SW67042 (Fig. 2) the window “Set Communication” appears (Fig. 3).

In the section “Select Device” it is possible to select the type of converter used:

- Device with Serial (RS232);
- Device with Ethernet.

The means of the fields for “CAN” section are:

- In the field **“Baudrate”** the data rate of the CAN is defined;
- In the field **“Type”** it is possible to define the type of CAN used (2.0A or 2.0B) (only if “Device with Serial (RS232)” is set);
- In the field **“TimeOut (s)”** the timeout of the data is defined. If the CAN frame is not received in this time, on CANopen side the value of the data of the CAN frame become “0” (only if “Device with Serial (RS232)” is set);
- If the field **“Send Cyclically (ms)”** is checked, the CAN frames in transmission are sent cyclically. The delay time is defined in the field on the right (only if “Device with Serial (RS232)” is set).

The means of the fields for “CANopen” are:

- In the field **“ID Device”** the CANopen ID for the converter is defined;
- In the field **“Baudrate”** the data rate of the CANopen is defined;
- If the field **“Set Operational State at Start-up”** is checked, the state of the CANopen is defined. I.e. if it is checked the board starts in Operational State, else it starts in Pre-Operational;

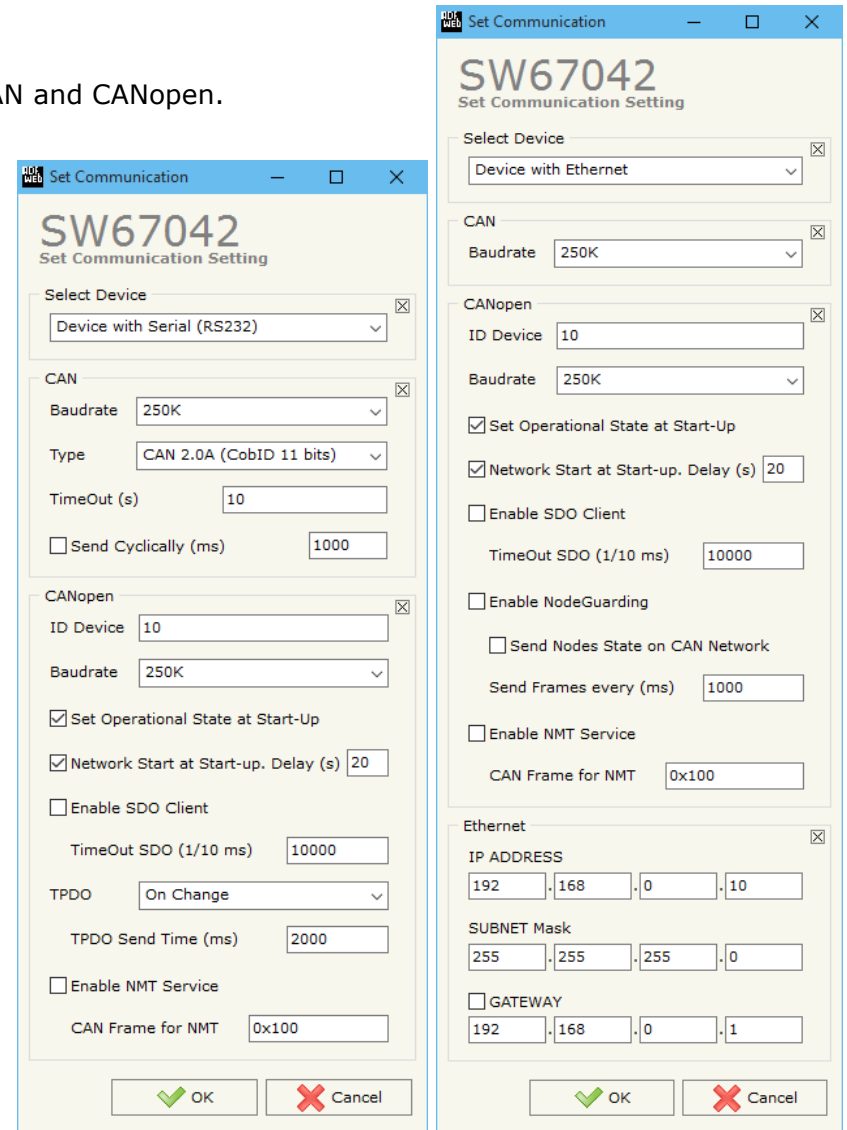

Figure 3: “Set Communication” windows

- If the field "**Network Start at Start-up**" is checked, the state of the CANopen network is defined. I.e. if it is checked the board sends a command to set the Operational State of all the devices present in the network. In the field "**Delay (s)**" the delay before sending the network command for the CANopen is defined;
- If the field "**Enable SDO Client**" is checked, the SDO Client function is enabled. In the field "**TimeOut SDO (1/10ms)**" the timeout for the SDO requests is defined;
- If the field "**Enable NodeGuarding**" is checked, the NodeGuarding function is enabled. It is possible to send the NodeGuarding information on CAN checking the option "**Send Nodes State on CAN Network**" with the defined delay in "**Send Frames every (ms)**" field (only if "Device with Ethernet" is set);
- In the field "**TPDO**" the transmission mode for the TPDOs is defined: it is possible to choose 'On Timer' or 'On Change'. If "On Timer" is defined, the delay between the TPDOs is defined in the field "**TPDO Send Time (ms)**" (only if "Device with Serial (RS232)" is set);
- If the field "**Enable NMT Service**" is enabled, it is possible to send NMT messages to CANopen devices from CAN. In the field "**CAN Frame for NMT**" the COB-ID for the CAN message is defined. Please, see page 36 for more info.

The means of the fields for "Ethernet" section are (only if "Device with Ethernet" is set):

- In the field "**IP Address**" the IP address of the converter is defined;
- In the field "**Subnet Mask**" the Subnet Mask of the converter is defined;
- If the field "**Gateway**" is checked it is possible to insert, in the field under, the IP Address of the Converter used for going out to the net.

### RECEIVE CAN:

By pressing the "Receive CAN" button from the main window for SW67042 (Fig. 2) the window "Receive CAN Frames" appears (Fig. 4). In this section, it is possible to define the CAN frames that the converter will receive from CAN network.

If "Device with Serial (RS232)" is set in the section "Set Communication", the window appears like below:

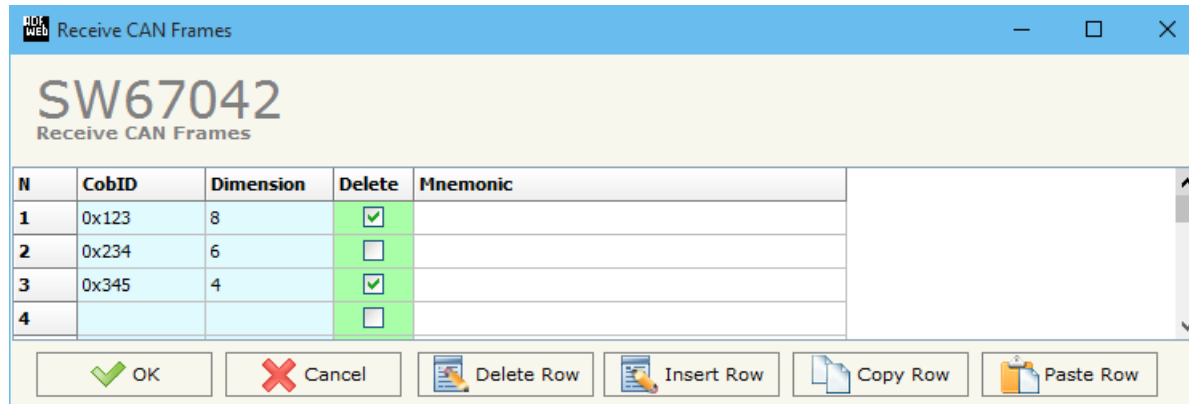

Figure 4a: "Receive CAN Frame Definition" window

- In the field "Cob-ID" insert the Cob-ID of the CAN frame;
- In the field "Dimension" insert the number of bytes of the CAN frame (the maximum dimension is 8 Bytes);
- If the field "Delete" is checked, if the CAN frame is not received in the timeout defined in the "Set Communication" window, the value of the data on CANopen side become "0";
- In the field "Mnemonic" a description of the frame is defined.



If "Device with Ethernet" is set in the section "Set Communication", the window appears like below:

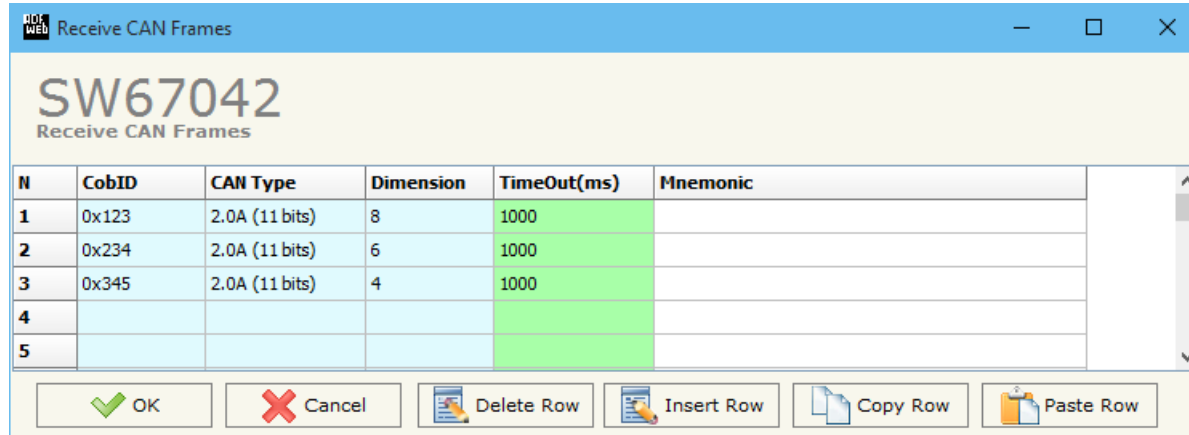

Figure 4b: "Receive CAN Frame Definition" window

- In the field "**Cob-ID**" insert the Cob-ID of the CAN frame;
- In the field "**Type**" insert the type of the CAN protocol used for each frame (CAN 2.0A (11 bits) or CAN 2.0B (29 bits));
- In the field "**Dimension**" insert the number of bytes of the CAN frame (the maximum dimension is 8 Bytes);
- In the field "**TimeOut**" insert the TimeOut; if the CAN frame is not received in the timeout defined, the value of the data on CANopen side become "0";
- In the field "**Mnemonic**" a description of the frame is defined.

## DEFINE SDO

By pressing the **Define SDO** button near "Receive CAN" from the main window for SW67042 (Fig. 2) the window "Define Read Server SDOs for Receive CAN Frames" appears (Fig. 5):

- In the field **List of Receive CAN Frames** there is the list of CAN Frames that you inserted in "Receive CAN" section.
- In the field **List of Server SDO in Read** there are the SDOs Objects in read.
- In the field **Create/Modify a Server SDO** you can define the Index, SubIndex and the Dimension of the SDO Object to create and the bytes of the CAN frame which you will map in.

For example:

Click on the CAN frame, insert the valid parameters in the fields "Index SDO", "SubIndex SDO" and "Dimension SDO", select which bytes of the CAN frame you want to map inside the SDO, click the "Create" button. In the field "List of Server SDO in Read" appears the new SDO Object created.

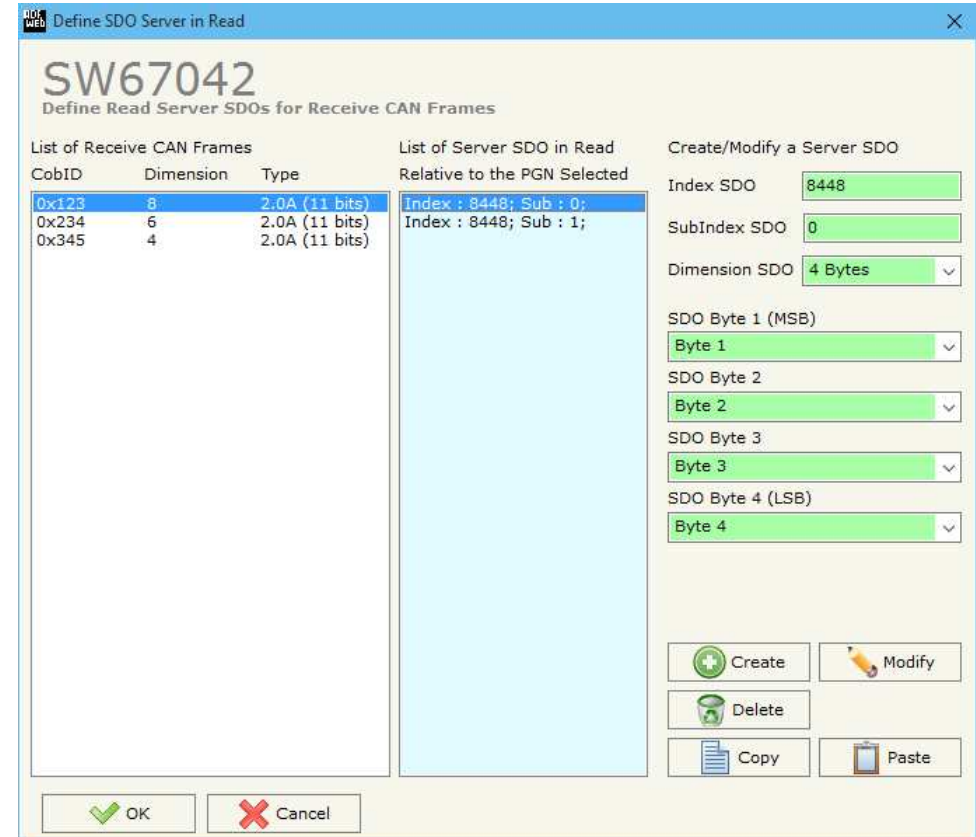

Figure 5: "Define Read Server SDOs for Receive CAN Frames" window

**DEFINE TPDO:**

By pressing the **Define TPDO** button from the main window of SW67042 (Fig. 2) the window "Define Transmit PDO" appears (Fig. 6): in this section, it is possible to define the PDO frames that the converter will send to the CANopen network.

If "Device with Serial (RS232)" is set in the section "Set Communication", the window appears like below:

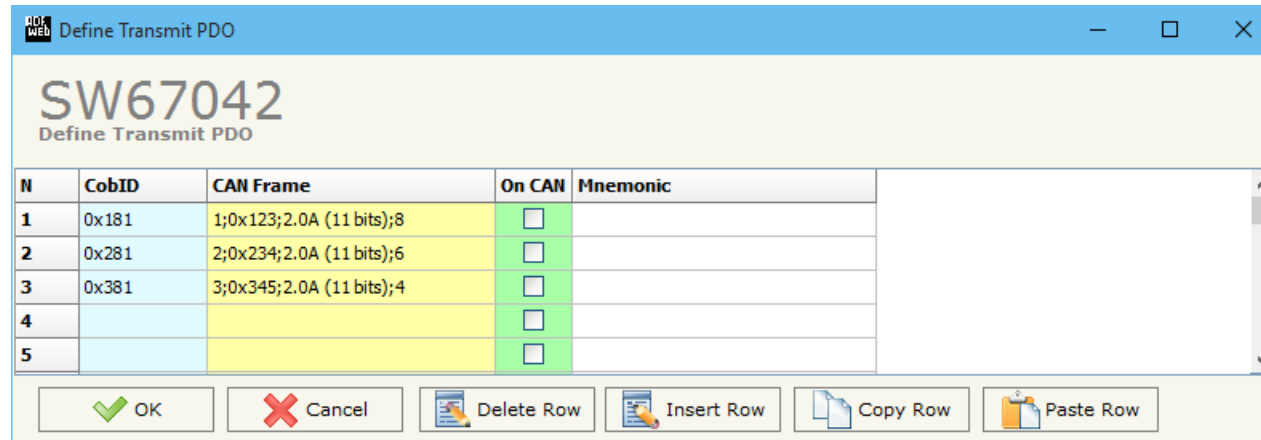

Figure 6a: "Define Transmit PDO" window

- In the field **CobID**, the Cob-ID of the PDO is defined;
- In the field **CAN Frame**, the CAN frame to link to the TPDO is defined;
- If the field **On CAN**, the TPDO is transmitted when the CAN frame linked is received;
- In the field **Mnemonic** a description of the frame is defined.

If "Device with Ethernet" is set in the section "Set Communication", the window appears like below:

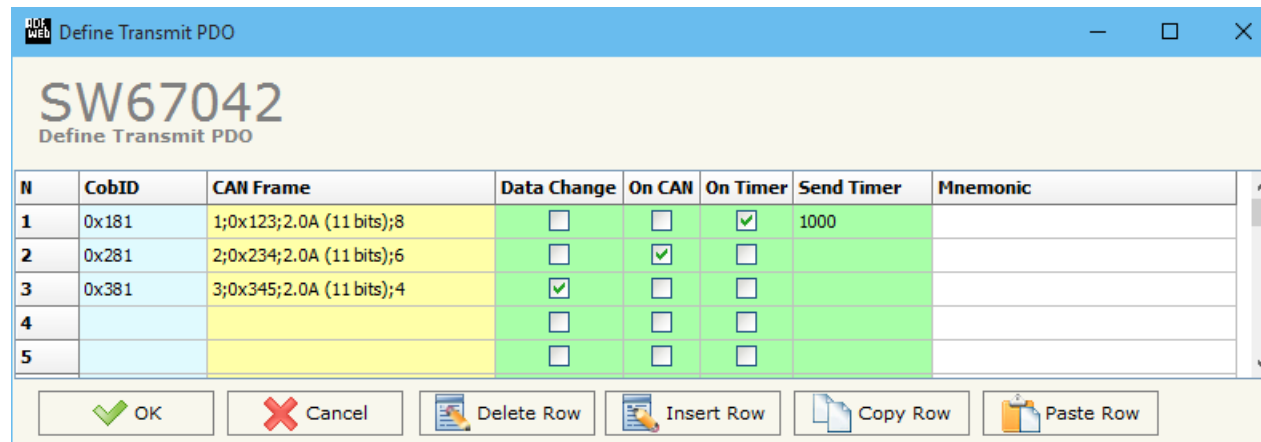

Figure 6b: "Define Transmit PDO" window

- In the field "**CobID**", the Cob-ID of the PDO is defined;
- In the field "**CAN Frame**", the CAN frame to link to the TPDO is defined;
- If the field "**Data Change**" is checked the TPDO frame is sent when the data into the linked CAN frame change;
- If the field "**On CAN**", the TPDO is transmitted when the CAN frame linked is received;
- If the field "**On Timer**" is checked the TPDO is sent cyclically;
- In the field "**Timer (ms)**" insert the cyclic delay for the "On Timer" option;
- In the field "**Mnemonic**", the description for the frame is defined.

**TRANSMIT CAN:**

By pressing the **“Transmit CAN”** button from the main window of SW67042 the window **“Transmit CAN Frames”** appears (Fig. 7): in this section, it is possible to define the CAN frames that the converter will send to the CAN network.

If **“Device with Serial (RS232)”** is set in the section **“Set Communication”**, the window appears like below:

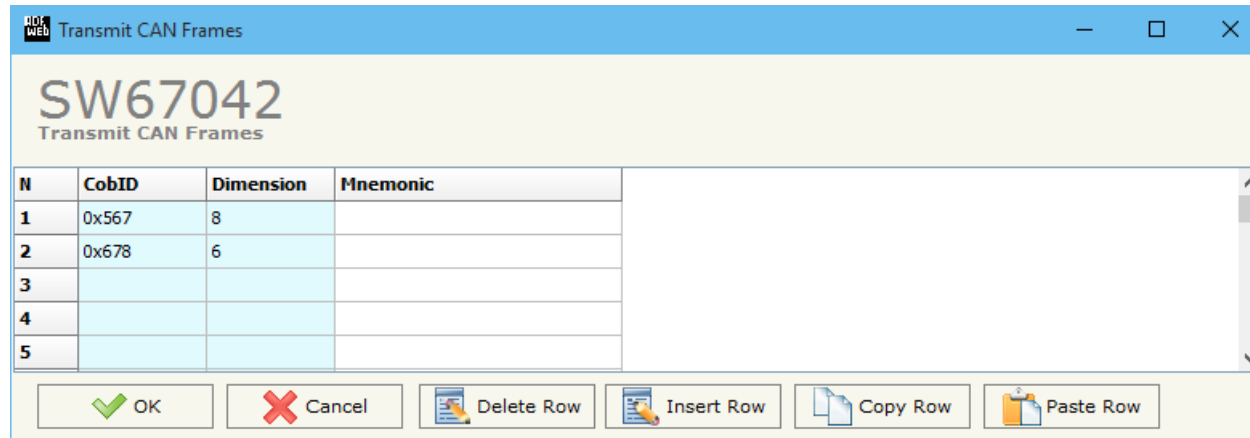

Figure 7a: **“Transmit CAN Frames”** window

- In the field **“Cob-ID”** insert the Cob-ID of the CAN frame;
- In the field **“Dimension”** insert the number of bytes of the CAN frame (the maximum dimension is 8 Bytes);
- In the field **“Mnemonic”** a description of the frame is defined.

If "Device with Ethernet" is set in the section "Set Communication", the window appears like below:

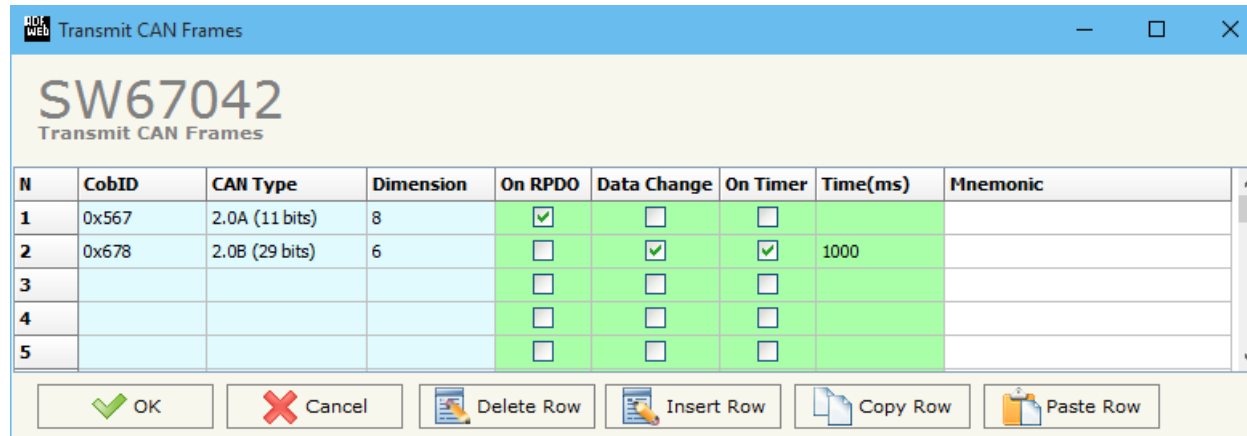

Figure 7b: "Transmit CAN Frames" window

- In the field "**Cob-ID**" insert the Cob-ID of the CAN frame;
- In the field "**Type**" insert the type of the CAN protocol used for each frame (CAN 2.0A (11 bits) or CAN 2.0B (29 bits));
- In the field "**Dimension**" insert the number of bytes of the CAN frame (the maximum dimension is 8 Bytes);
- If the field "**On RPDO**", the CAN frame is transmitted when the RPDO linked is received;
- If the field "**On Change**" is checked the CAN frame is sent when the data of the RPDO linked change;
- If the field "**On Timer**" is checked the CAN frame is sent cyclically;
- In the field "**Timer (ms)**" insert the cyclic delay for the "On Timer" option;
- In the field "**Mnemonic**" the description for the frame is defined.



## DEFINE SDO

By pressing the **Define SDO** button near "Transmit CAN" from the main window for SW67042 (Fig. 2) the window "Define Write Server SDOs for Transmit CAN Frames" appears (Fig. 8):

- In the field **List of Transmit CAN Frames** there is the list of CAN Frames that you inserted in "Transmit CAN" section.
- In the field **List of Server SDO in Write** there are the SDOs Objects in read.
- In the field **Create/Modify a Server SDO** you can define the Index, SubIndex and the Dimension of the SDO Object to create and the bytes of the CAN frame which you will map to.
- With the field **Send CAN frame When Write SDO** it is possible to decide when sending the CAN frame. If this option is "True", the CAN frame is transmitted when the selected SDO is written.

For example:

Click on the CAN frame, insert the valid parameters in the fields "Index SDO", "SubIndex SDO" and "Dimension SDO", select which bytes of the CAN frame you want to map inside the SDO, click the "Create" button. In the field "List of Server SDO in Write" appears the new SDO Object created.

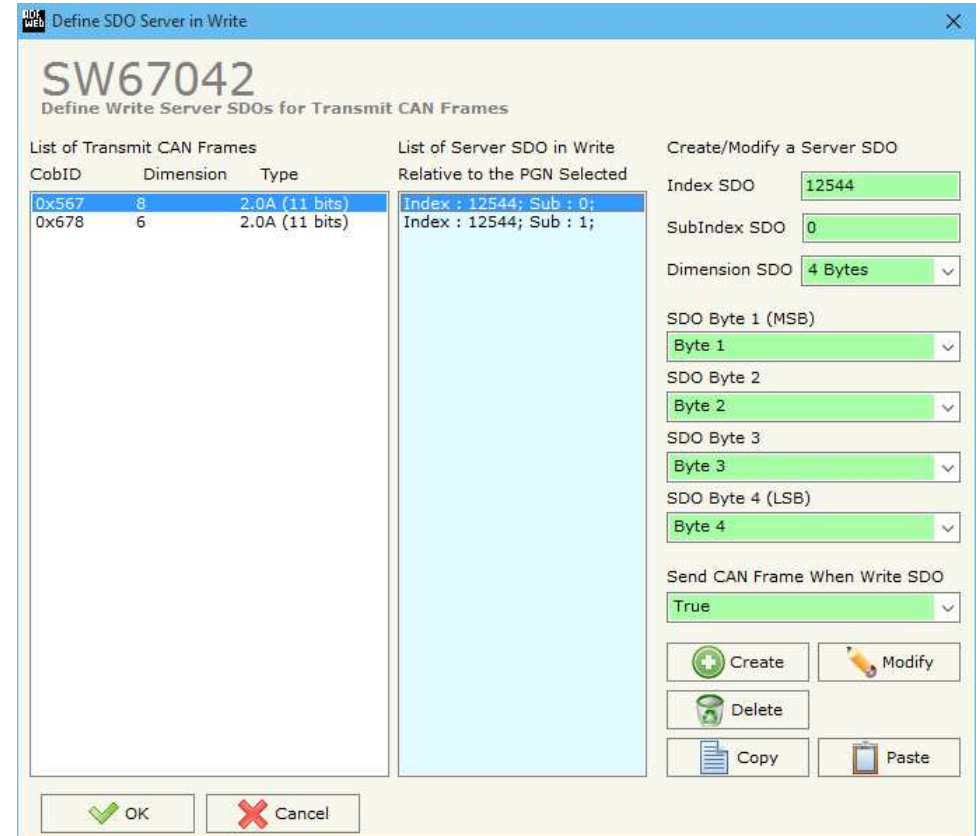

Figure 8: "Define Write Server SDOs for Transmit CAN Frames" window

**DEFINE RPDO:**

By pressing the **Define RPDO** button from the main window for SW67042 (Fig. 2) the window "Define Receive PDO" appears (Fig. 9). In this section, it is possible to define the PDO frames that the converter will receive from CANopen network.

If "Device with Serial (RS232)" is set in the section "Set Communication", the window appears like below:

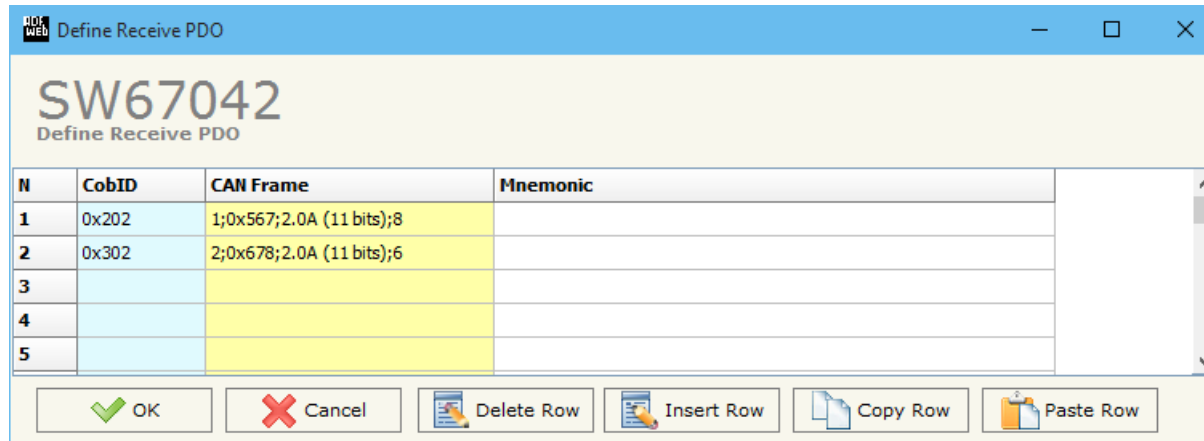

Figure 9a: "Define Receive PDO" window

- ✦ In the field **Cob-ID**, the Cob-ID of the PDO is defined;
- ✦ In the field **CAN Frame**, the CAN frame to link to the RPDO is defined;
- ✦ In the field **Mnemonic**, a description of the PDO is defined.

If "Device with Ethernet" is set in the section "Set Communication", the window appears like below:

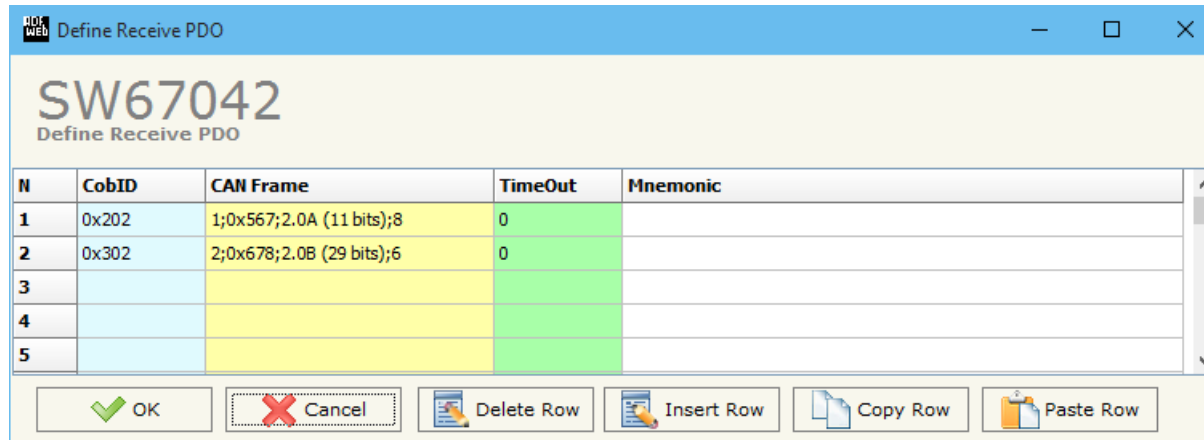

Figure 9b: "Define Receive PDO" window

- ✦ In the field "**Cob-ID**", the Cob-ID of the PDO is defined;
- ✦ In the field "**CAN Frame**", the CAN frame to link to the RPDO is defined;
- ✦ If the field "**TimeOut**" the TimeOut is defined; after the TimeOut defined, the value of the data of the PDO become "0";
- ✦ In the field "**Mnemonic**" a description of the frame is defined.

**SET SDO CLIENT:**

By pressing the **“Set SDO Client”** button from the main window of SW67042 (Fig. 2) the window **“Define CAN Frames to use the Client SDO”** appears (Fig. 10).

In this window is possible to configure five CAN messages used to read and write SDO data from other devices in the network CANopen.

The first two frames are used to read a SDO, the last three messages are used to write a SDO.

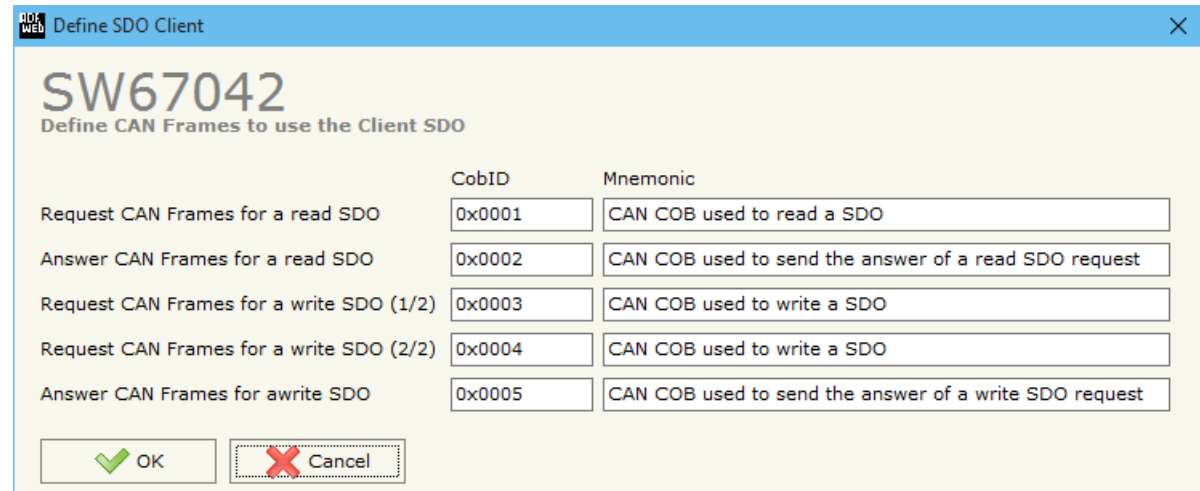

Figure 10: "Define CAN Frames to use the Client SDO" window

**READ SDO**

*Request frame CAN to read a SDO*

When the gateway receive this message, it sends a read SDO request to CANopen network. The coordinates of the SDO are inside the data bytes of the CAN message in this format:

Byte1	Byte2	Byte3	Byte4	Byte5	Byte6	Byte7	Byte8
ID Device	Index	Index	SubIndex	Num Byte	Not used = 0	Not used = 0	Not used = 0

*Answer frame CAN of a read SDO*

The gateway sends this frame with the answer of the SDO. The Data bytes of this message are so formed:

Byte1	Byte2	Byte3	Byte4	Byte5	Byte6	Byte7	Byte8
ID Device REQ	Index REQ	Index REQ	SubIndex REQ	Data byte 1	Data byte 2	Data byte 3	Data byte 4

**WRITE SDO**

*Request frame CAN to write a SDO (1/2)*

When the gateway receive this message it save the coordinates of write SDO request.

The coordinates of the SDO are inside the data bytes of the CAN message in this format:

Byte1	Byte2	Byte3	Byte4	Byte5	Byte6	Byte7	Byte8
ID Device	Index	Index	SubIndex	Num Byte	Not used = 0	Not used = 0	Not used = 0

*Request frame CAN to write a SDO (2/2)*

When the gateway receive this message it send the SDO write request in CANopen network.

The coordinates of the SDO are inside the data bytes of the CAN message in this format:

Byte1	Byte2	Byte3	Byte4	Byte5	Byte6	Byte7	Byte8
Data Byte 1	Data Byte 2	Data Byte 3	Data Byte 4	Not used = 0	Not used = 0	Not used = 0	Not used = 0

*Answer frame CAN of a write SDO*

The gateway send this frame when a Write SDO request finish correctly.

The Data byte of this message are so formed:

Byte1	Byte2	Byte3	Byte4	Byte5	Byte6	Byte7	Byte8
ID Device REQ	Index REQ	Index REQ	SubIndex REQ	1	Not used = 0	Not used = 0	Not used = 0

**SET NODEGUARDING (only for “Device with Ethernet”):**

By pressing the “**Set NodeGuarding**” button from the Main Window of SW67042 (Fig. 2) the “Define Node Guarding” window appears (Fig. 11).

- In the field “**Node ID**”, the address of the CANopen device that you want to control is defined. It is possible to insert up to 32 address;
- In the field “**Guard Time**”, the Guard Time is defined. This value indicates the delay between two interrogations;
- In the field “**Life Time Factor**”, the number of attempts before considering the device absent is defined;
- In the field “**Mnemonic**”, a description is defined.

In the fields below, it is possible to define the CAN messages where mapping the informations of the Node Guarding. The first byte of each CAN frame will contain the status of 7 CANopen devices (1 = present or 0 = not present). The others 7 bytes will contain the status of the monitored CANopen devices.

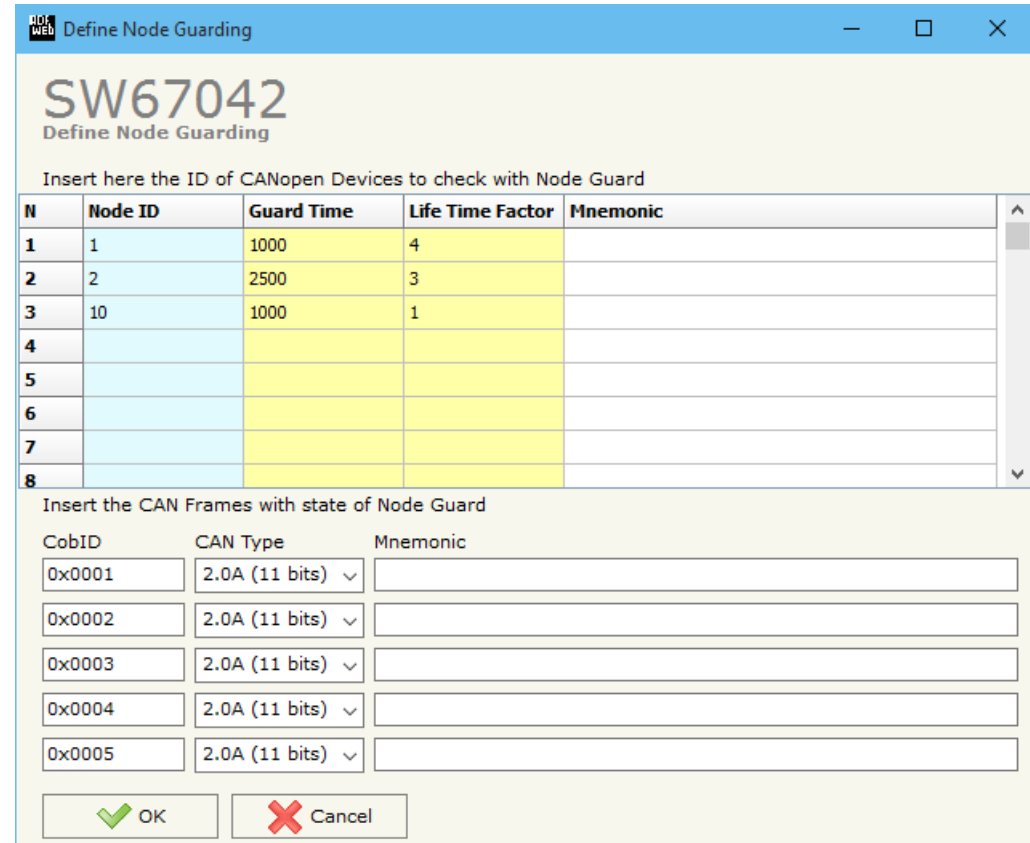

Figure 11: “Define Node Guarding” window

**EDS FILE:**

By Pressing the “**EDS File**” button from the main window for SW67042 (Fig. 2) it is possible to generate the EDS file to be imported into the CANopen Client.

**UPDATE DEVICE (for “Device with Serial (RS232)”):**

By pressing the “**Update Device**” button it is possible to load the created Configuration into the device, and also the Firmware if is necessary, using the RS232 port.

In order to load the parameters or update the firmware in the device, follow these instructions:

- Turn OFF the Device;
- Connect the RS232 cable from your PC to the Converter;
- Put the converter in Boot Mode;
- Select the “**COM port**” and press the “**Connect**” button;
- Turn on the device;
- Check the “Device state” Led. It must blink quickly (see “LEDS” section);
- Press the “**Next**” button;
- Select which operations you want to do.
- Press the “**Execute update firmware**” button to start the upload;
- When all the operations are “OK” turn off the device;
- Put the converter in Run Mode;
- Disconnect the RS232 cable;
- Turn ON the device.

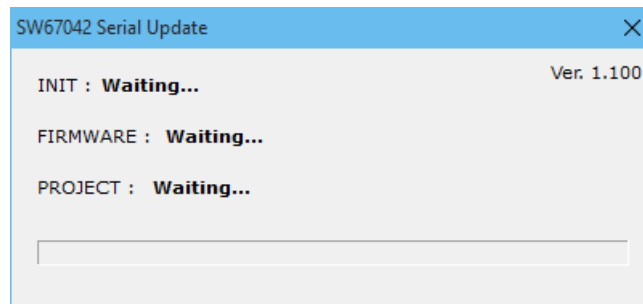
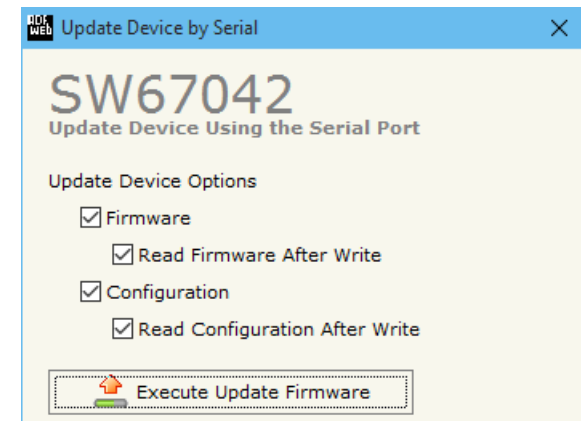
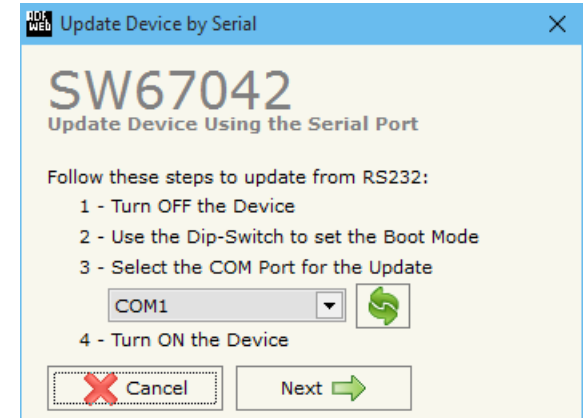

Figure 12: “Update via Serial” windows

**UPDATE DEVICE (for "Device with Ethernet"):**

By pressing the "Update Device" button, it is possible to load the created Configuration into the device; and also the Firmware, if necessary.

If you don't know the actual IP address of the device you have to use this procedure:

- Turn off the Device;
- Put Dip2 of 'Dip-Switch A' in ON position;
- Turn on the device
- Connect the Ethernet cable;
- Insert the IP "192.168.2.205";
- Press the "Ping" button, "Device Found! must appear";
- Press the "Next" button;
- Select which operations you want to do;
- Press the "Execute update firmware" button to start the upload;
- When all the operations are "OK" turn off the Device;
- Put Dip2 of 'Dip-Switch A' in OFF position;
- Turn on the device.

At this point the configuration/firmware on the device is correctly updated.

If you know the actual IP address of the device, you have to use this procedure:

- Turn on the Device with the Ethernet cable inserted;
- Insert the actual IP of the Converter;
- Press the "Ping" button, must appear "Device Found!";
- Press the "Next" button;
- Select which operations you want to do;
- Press the "Execute update firmware" button to start the upload;
- When all the operations are "OK" the device automatically goes at Normal Mode.

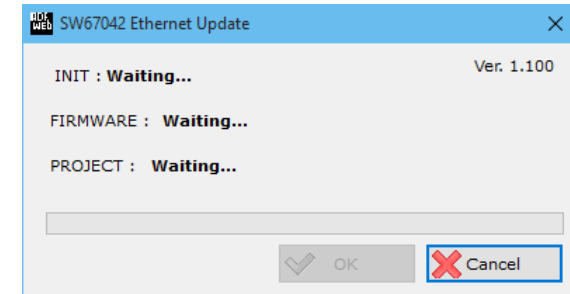
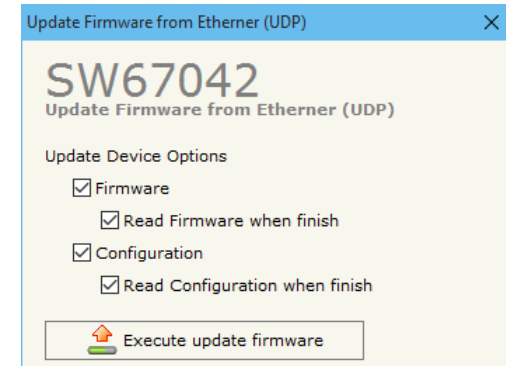
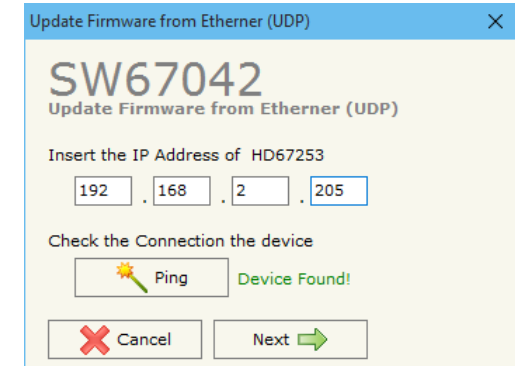

Figure 13: "Update via Ethernet" windows





**Note:**

When you install a new version of the software, if it is the first time it is better you do the update of the Firmware in the HD67042 device.



**Note:**

When you receive the device, for the first time, you also have to update the Firmware in the HD67042 device.



**Warning:**

If Fig. 14 appears when you try to do the Update try these points before seeking assistance:

- Check if the serial COM port selected is the correct one;
- Check if the serial cable is connected between the PC and the device;
- Try to repeat the operations for the updating;
- If you are using a USB↔RS232 converter try with a native COM port or change the converter;
- Try to repeat the operations for the updating;
- Try with another PC;
- Try to restart the PC;
- Check the LAN settings;
- If you are using the program inside a Virtual Machine, try to use in the main Operating System;
- If you are using Windows Seven, Vista, 8 and 10 make sure that you have the administrator privileges;
- In case you have to program more than one device, using the "UDP Update", you have to cancel the ARP table every time you connect a new device on Ethernet. For do this you have to launch the "Command Prompt" and write the command "arp -d". Pay attention that with Windows Vista, Seven, 8 you have to launch the "Command Prompt" with Administrator Rights;
- Pay attention at Firewall lock.

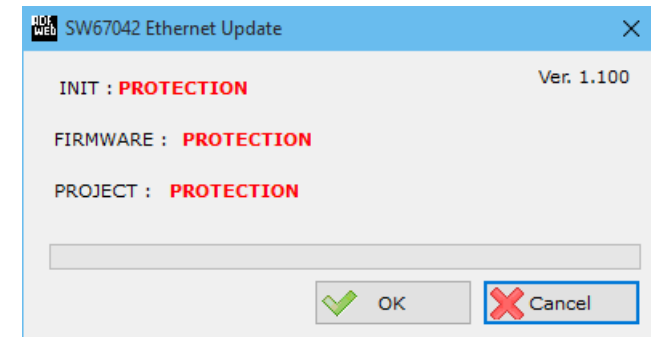

Figure 14: "Protection" window

In the case of HD67042 you have to use the software "SW67042": [www.adfweb.com/download/filefold/SW67042.zip](http://www.adfweb.com/download/filefold/SW67042.zip).

At this point the configuration/firmware on the device is correctly updated.

**NMT REQUESTS:**

To send a NMT request to a CANopen device, it is necessary to send a CAN frame to the Converter with the COB-ID equal to the "CAN frame for NMT" setted in the "Set Communication" section. The frame must have at least 2 data bytes. The first byte is used to decide the NMT Request to send and the second byte is used to indicate the CANopen ID device where to send the NMT request. The NMT Request that the gateway can send are (first byte of the CAN Frame):

Value	Description
1	Start Remote Node (Operationa state)
2	Stop Remote Node
128	Pre-Operational Remote Node
129	Reset Remote Node
130	Reset Communication

The CANopen ID Device (Second Byte of the CAN frame) can go from 1 to 127 for send a request to a single CANopen device or the value 0 to send a broadcast message.

**MECHANICAL DIMENSIONS:**

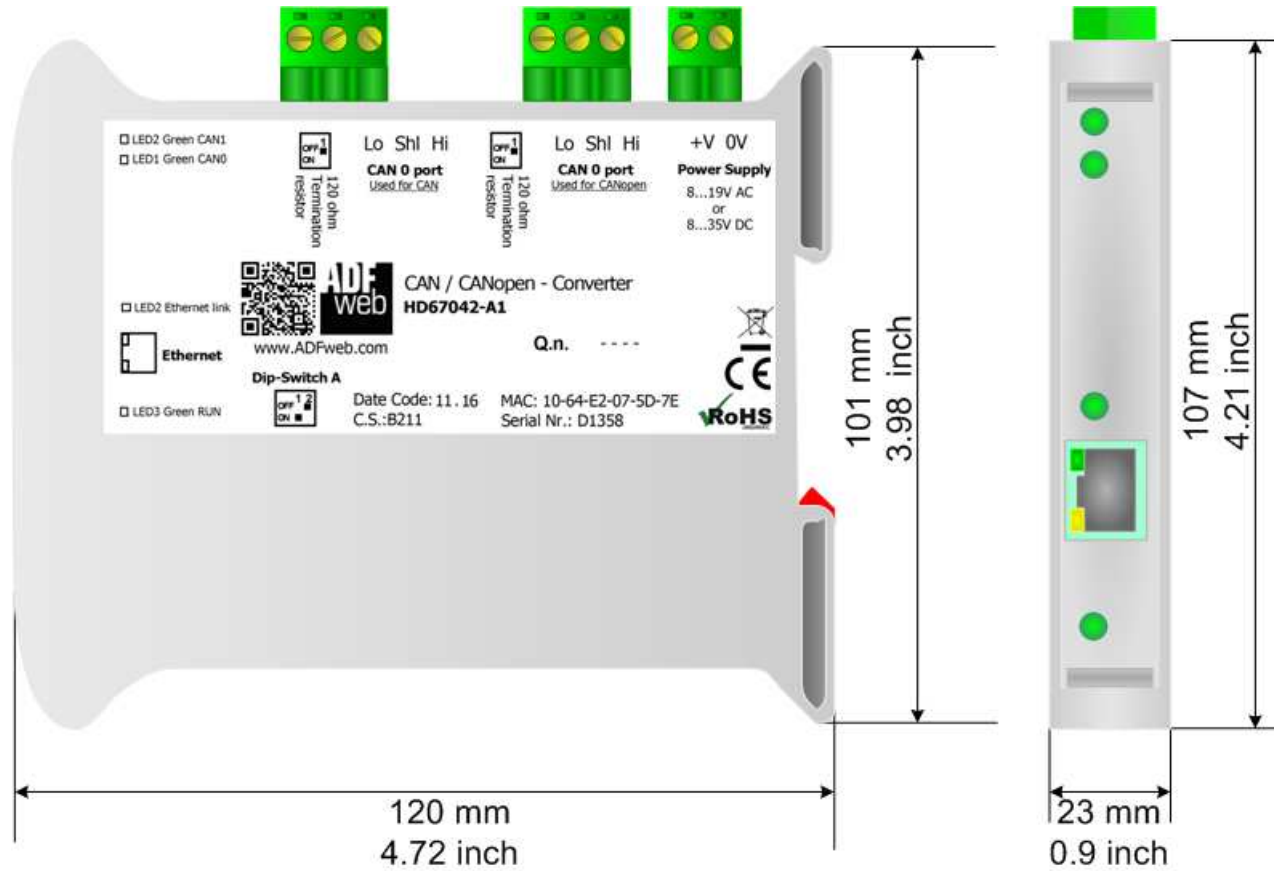

Housing: PVC  
 Weight: 200g (Approx)

Figure 15: Mechanical dimensions scheme for HD67042-Ax

**ORDERING INFORMATIONS:**

The ordering part number is formed by a valid combination of the following:

**HD67042 - A x**

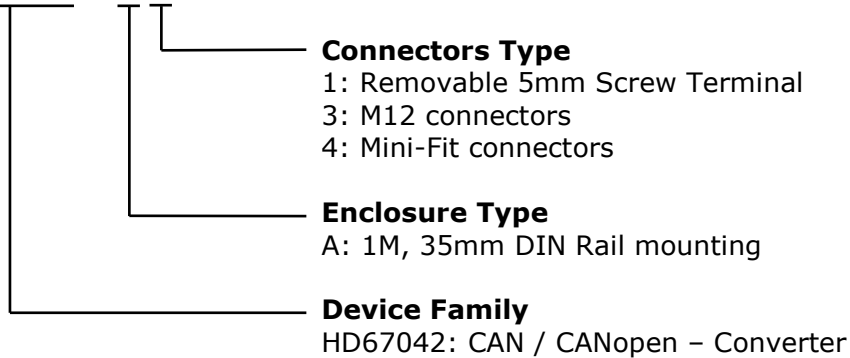

- Order Code: **HD67042-A1** - CAN / CANopen - Converter (Terminal Blocks connectors)
- Order Code: **HD67042-A3** - CAN / CANopen - Converter (M12 connectors)
- Order Code: **HD67042-A4** - CAN / CANopen - Converter (Mini-Fit connectors)

**ACCESSORIES:**

- Order Code: **AC34001** - 35mm Rail DIN - Power Supply 220/240V AC 50/60Hz - 12 V AC
- Order Code: **AC34002** - 35mm Rail DIN - Power Supply 110V AC 50/60Hz - 12 V AC

## DISCLAIMER:

All technical content within this document can be modified without notice. The content of the document is a under continual renewal. For losses due to fire, earthquake, third party access or other accidents, or intentional or accidental abuse, misuse, or use under abnormal conditions repairs are charged to the user. ADFweb.com S.r.l. will not be liable for accidental loss of use or inability to use this product, such as loss of business income. ADFweb.com S.r.l. shall not be liable for consequences of improper use.

## OTHER REGULATIONS AND STANDARDS:

### WEEE INFORMATION



Disposal of old electrical and electronic equipment (as in the European Union and other European countries with separate collection systems).

— This symbol on the product or on its packaging indicates that this product may not be treated as household rubbish. Instead, it should be taken to an applicable collection point for the recycling of electrical and electronic equipment. If the product is disposed correctly, you will help prevent potential negative environmental factors and impact of human health, which could otherwise be caused by inappropriate disposal. The recycling of materials will help to conserve natural resources. For more information about recycling this product, please contact your local city office, your household waste disposal service or the shop where you purchased the product.

### RESTRICTION OF HAZARDOUS SUBSTANCES DIRECTIVE



The device respects the 2002/95/EC Directive on the restriction of the use of certain hazardous substances in electrical and electronic equipment (commonly referred to as Restriction of Hazardous Substances Directive or RoHS).

### CE MARKING



The product conforms with the essential requirements of the applicable EC directives.

**WARRANTIES AND TECHNICAL SUPPORT:**

For fast and easy technical support for your ADFweb.com SRL products, consult our internet support at [www.adfweb.com](http://www.adfweb.com).  
Otherwise contact us at the address [support@adfweb.com](mailto:support@adfweb.com)

**RETURN POLICY:**

If while using your product you have any problem and you wish to exchange or repair it, please do the following:

- Obtain a Product Return Number (PRN) from our internet support at [www.adfweb.com](http://www.adfweb.com). Together with the request, you need to provide detailed information about the problem.
- Send the product to the address provided with the PRN, having prepaid the shipping costs (shipment costs billed to us will not be accepted).

If the product is within the warranty of twelve months, it will be repaired or exchanged and returned within three weeks. If the product is no longer under warranty, you will receive a repair estimate.



**ADFweb.com S.r.l.**  
Via Strada Nuova, 17  
IT-31010 Mareno di Piave  
TREVISO (Italy)  
Phone +39.0438.30.91.31  
Fax +39.0438.49.20.99  
[www.adfweb.com](http://www.adfweb.com)

