

# User Manual

Revision 1.100  
English

## SNMP Agent / CANopen - Converter

(Order Code: HD67156-A1, HD67156-B2)

for Website information:

[www.adfweb.com?Product=HD67156](http://www.adfweb.com?Product=HD67156)

for Price information:

[www.adfweb.com?Price=HD67156-A1](http://www.adfweb.com?Price=HD67156-A1)

[www.adfweb.com?Price=HD67156-B2](http://www.adfweb.com?Price=HD67156-B2)

### Benefits and Main Features:

- ⊕ Very easy to configure
- ⊕ Electrical isolation
- ⊕ Temperature range: -40°C/85°C (-40°F/185°F)



User Manual

For others SNMP Agent products, see also the following links:

#### Converter SNMP to

[www.adfweb.com?Product=HD67039](http://www.adfweb.com?Product=HD67039)  
[www.adfweb.com?Product=HD67092](http://www.adfweb.com?Product=HD67092)  
[www.adfweb.com?Product=HD67155](http://www.adfweb.com?Product=HD67155)  
[www.adfweb.com?Product=HD67158](http://www.adfweb.com?Product=HD67158)  
[www.adfweb.com?Product=HD67159](http://www.adfweb.com?Product=HD67159)  
[www.adfweb.com?Product=HD67160](http://www.adfweb.com?Product=HD67160)  
[www.adfweb.com?Product=HD67161](http://www.adfweb.com?Product=HD67161)  
[www.adfweb.com?Product=HD67162](http://www.adfweb.com?Product=HD67162)  
[www.adfweb.com?Product=HD67163](http://www.adfweb.com?Product=HD67163)  
[www.adfweb.com?Product=HD67164](http://www.adfweb.com?Product=HD67164)  
[www.adfweb.com?Product=HD67165](http://www.adfweb.com?Product=HD67165)  
[www.adfweb.com?Product=HD67166](http://www.adfweb.com?Product=HD67166)  
[www.adfweb.com?Product=HD67167](http://www.adfweb.com?Product=HD67167)  
[www.adfweb.com?Product=HD67168](http://www.adfweb.com?Product=HD67168)  
[www.adfweb.com?Product=HD67169](http://www.adfweb.com?Product=HD67169)  
[www.adfweb.com?Product=HD67613](http://www.adfweb.com?Product=HD67613)  
[www.adfweb.com?Product=HD67693](http://www.adfweb.com?Product=HD67693)  
[www.adfweb.com?Product=HD67726](http://www.adfweb.com?Product=HD67726)  
[www.adfweb.com?Product=HD67754](http://www.adfweb.com?Product=HD67754)  
[www.adfweb.com?Product=HD67779](http://www.adfweb.com?Product=HD67779)  
[www.adfweb.com?Product=HD67820](http://www.adfweb.com?Product=HD67820)  
[www.adfweb.com?Product=HD67850](http://www.adfweb.com?Product=HD67850)  
[www.adfweb.com?Product=HD67878](http://www.adfweb.com?Product=HD67878)  
[www.adfweb.com?Product=HD67913](http://www.adfweb.com?Product=HD67913)  
[www.adfweb.com?Product=HD67954](http://www.adfweb.com?Product=HD67954)  
[www.adfweb.com?Product=HD67987](http://www.adfweb.com?Product=HD67987)  
[www.adfweb.com?Product=HD67B23](http://www.adfweb.com?Product=HD67B23)  
[www.adfweb.com?Product=HD67B48](http://www.adfweb.com?Product=HD67B48)  
[www.adfweb.com?Product=HD67C79](http://www.adfweb.com?Product=HD67C79)  
[www.adfweb.com?Product=HD67D41](http://www.adfweb.com?Product=HD67D41)  
[www.adfweb.com?Product=HD67E25](http://www.adfweb.com?Product=HD67E25)  
[www.adfweb.com?Product=HD67E74](http://www.adfweb.com?Product=HD67E74)  
[www.adfweb.com?Product=HD67F41](http://www.adfweb.com?Product=HD67F41)

**(DMX)**  
**(M-Bus Wireless)**  
**(CAN)**  
**(EtherNet/IP Master)**  
**(EtherNet/IP Slave)**  
**(DeviceNet Master)**  
**(DeviceNet Slave)**  
**(J1939)**  
**(M-Bus Master)**  
**(Modbus Master)**  
**(Modbus Slave)**  
**(Modbus TCP Master)**  
**(Modbus TCP Slave)**  
**(PROFIBUS Master)**  
**(PROFIBUS Slave)**  
**(PROFINET)**  
**(BACnet Slave)**  
**(BACnet Master)**  
**(IEC61850 Server)**  
**(IEC61850 Client)**  
**(KNX)**  
**(DALI)**  
**(IO-Link Master)**  
**(HART)**  
**(MQTT)**  
**(IO-Link Slave)**  
**(OPC UA Client)**  
**(OPC UA Server)**  
**(EnOcean)**  
**(LoRaWAN)**  
**(EtherCAT Slave)**  
**(EtherCAT Master)**  
**(LoRaWAN Gateway)**

Do you have an your customer protocol?

[www.adfweb.com?Product=HD67003](http://www.adfweb.com?Product=HD67003)

Do you need to choose a device? do you want help?

[www.adfweb.com?Cmd=helpme](http://www.adfweb.com?Cmd=helpme)

**INDEX:**

	Page
INDEX	2
UPDATED DOCUMENTATION	2
REVISION LIST	2
WARNING	2
TRADEMARKS	2
SECURITY ALERT	3
EXAMPLE OF CONNECTION	4
CONNECTION SCHEME	5
CHARACTERISTICS	7
CONFIGURATION	7
POWER SUPPLY	8
FUNCTION MODES	9
LEDS	10
SNMP	11
CAN	12
USE OF COMPOSITOR SW67156	13
NEW PROJECT / OPEN PROJECT	14
SOFTWARE OPTIONS	15
SET COMMUNICATION	16
SET SDO SERVER	18
SET SDO CLIENT	19
SET PDO ACCESS	21
SET NODE GUARDING	23
RESTART DEVICES	24
SET SNMP ACCESS	25
PROFINET XML	27
EDS FILE	27
UPDATE DEVICE	28
SNMP COMMUNICATION	30
ASYNCR SDO REQUESTS	35
MECHANICAL DIMENSIONS	36
ORDERING INFORMATIONS	38
ACCESSORIES	38
DISCLAIMER	39
OTHER REGULATIONS AND STANDARDS	39
WARRANTIES AND TECHNICAL SUPPORT	40
RETURN POLICY	40

**UPDATED DOCUMENTATION:**

Dear customer, we thank you for your attention and we remind you that you need to check that the following document is:

- ✚ Updated
- ✚ Related to the product you own

To obtain the most recently updated document, note the “document code” that appears at the top right-hand corner of each page of this document.

With this “Document Code” go to web page [www.adfweb.com/download/](http://www.adfweb.com/download/) and search for the corresponding code on the page. Click on the proper “Document Code” and download the updates.

**REVISION LIST:**

Revision	Date	Author	Chapter	Description
1.000	05/05/2022	Ff	All	First Release

**WARNING:**

ADFweb.com reserves the right to change information in this manual about our product without warning. ADFweb.com is not responsible for any error this manual may contain.

**TRADEMARKS:**

All trademarks mentioned in this document belong to their respective owners.

**SECURITY ALERT:****GENERAL INFORMATION**

To ensure safe operation, the device must be operated according to the instructions in the manual. When using the device, legal and safety regulation are required for each individual application. The same applies also when using accessories.

**INTENDED USE**

Machines and systems must be designed so the faulty conditions do not lead to a dangerous situation for the operator (i.e. independent limit switches, mechanical interlocks, etc.).

**QUALIFIED PERSONNEL**

The device can be used only by qualified personnel, strictly in accordance with the specifications. Qualified personnel are persons who are familiar with the installation, assembly, commissioning and operation of this equipment and who have appropriate qualifications for their job.

**RESIDUAL RISKS**

The device is state-of-the-art and is safe. The instruments can represent a potential hazard if they are inappropriately installed and operated by untrained personnel. These instructions refer to residual risks with the following symbol:



This symbol indicates that non-observance of the safety instructions is a danger for people that could lead to serious injury or death and / or the possibility of damage.

**CE CONFORMITY**

The declaration is made by our company. You can send an email to [support@adfweb.com](mailto:support@adfweb.com) or give us a call if you need it.

**EXAMPLE OF CONNECTION:**

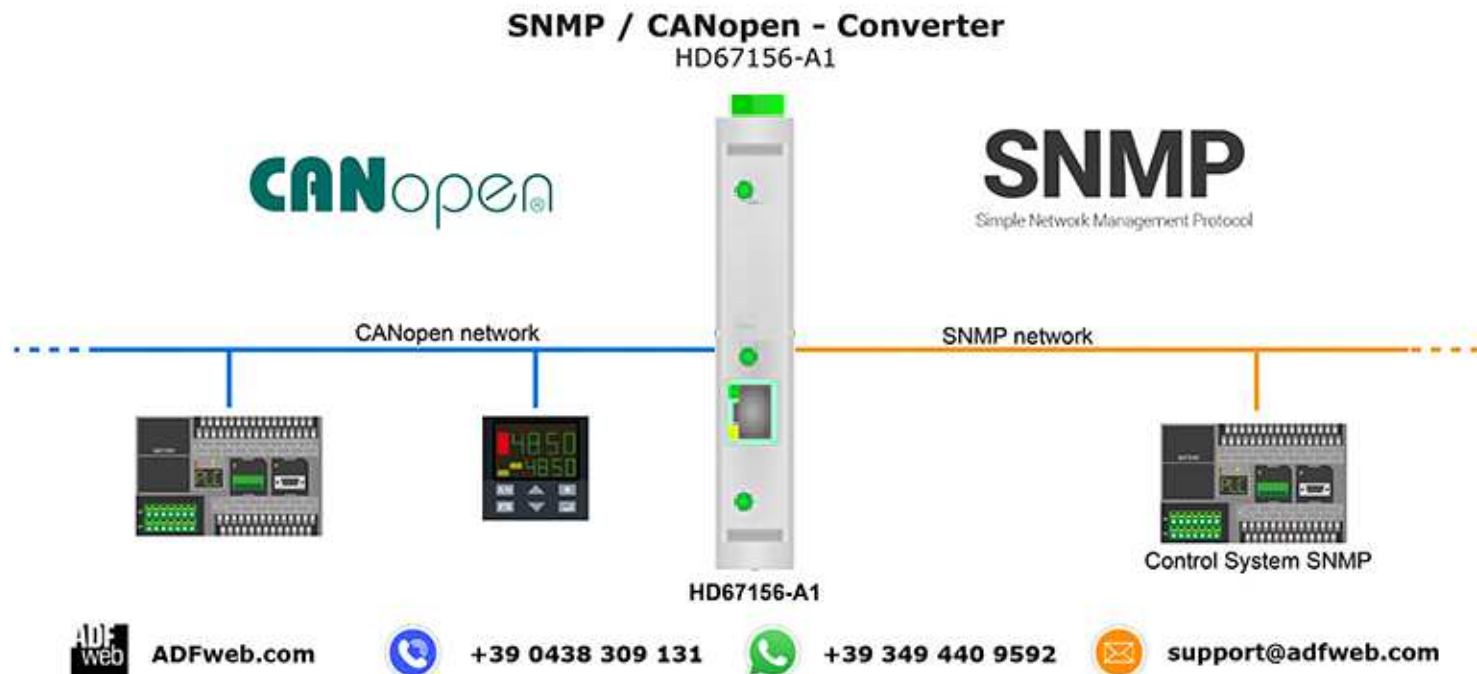

**CONNECTION SCHEME:**

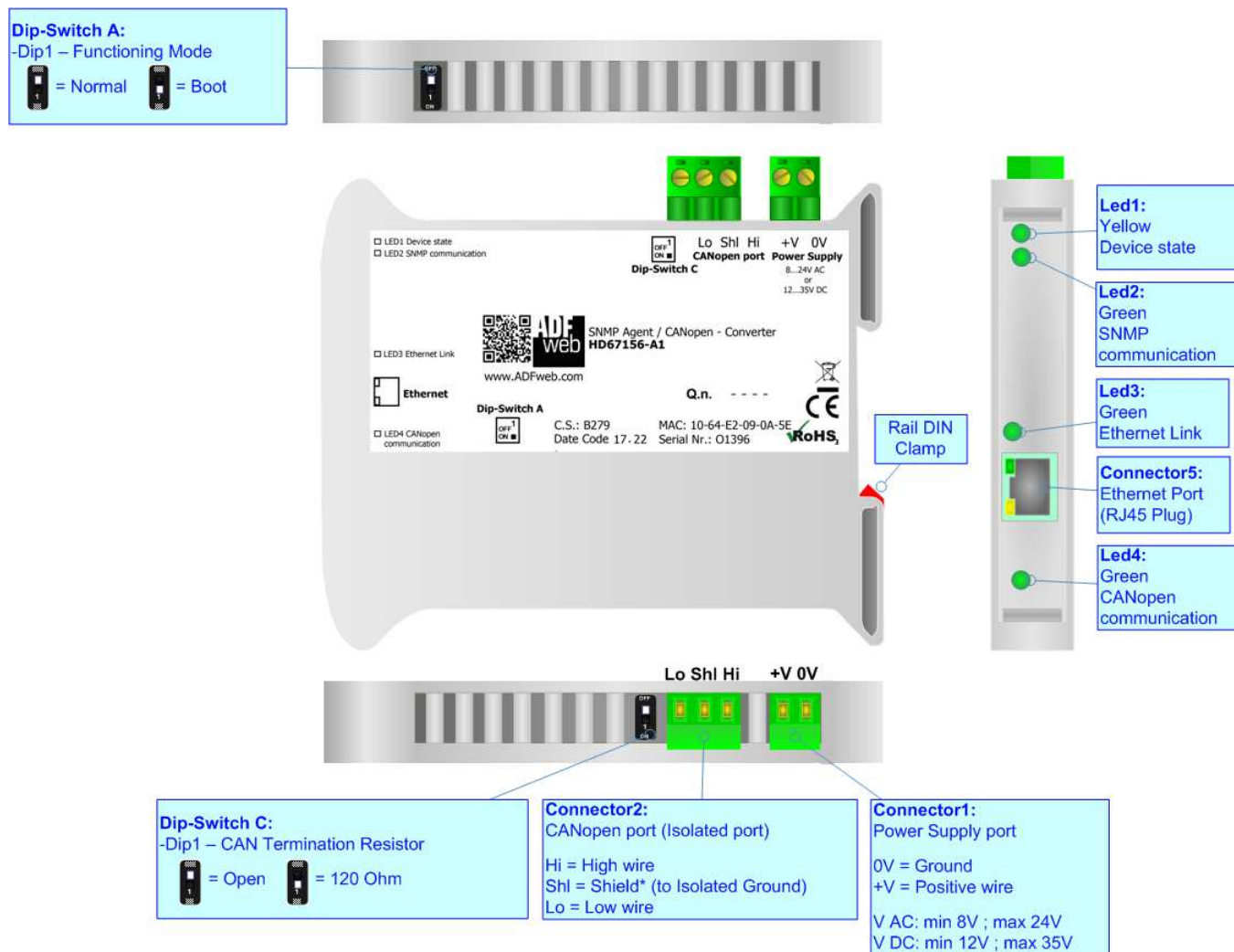

Figure 1a: Connection scheme for HD67156-A1

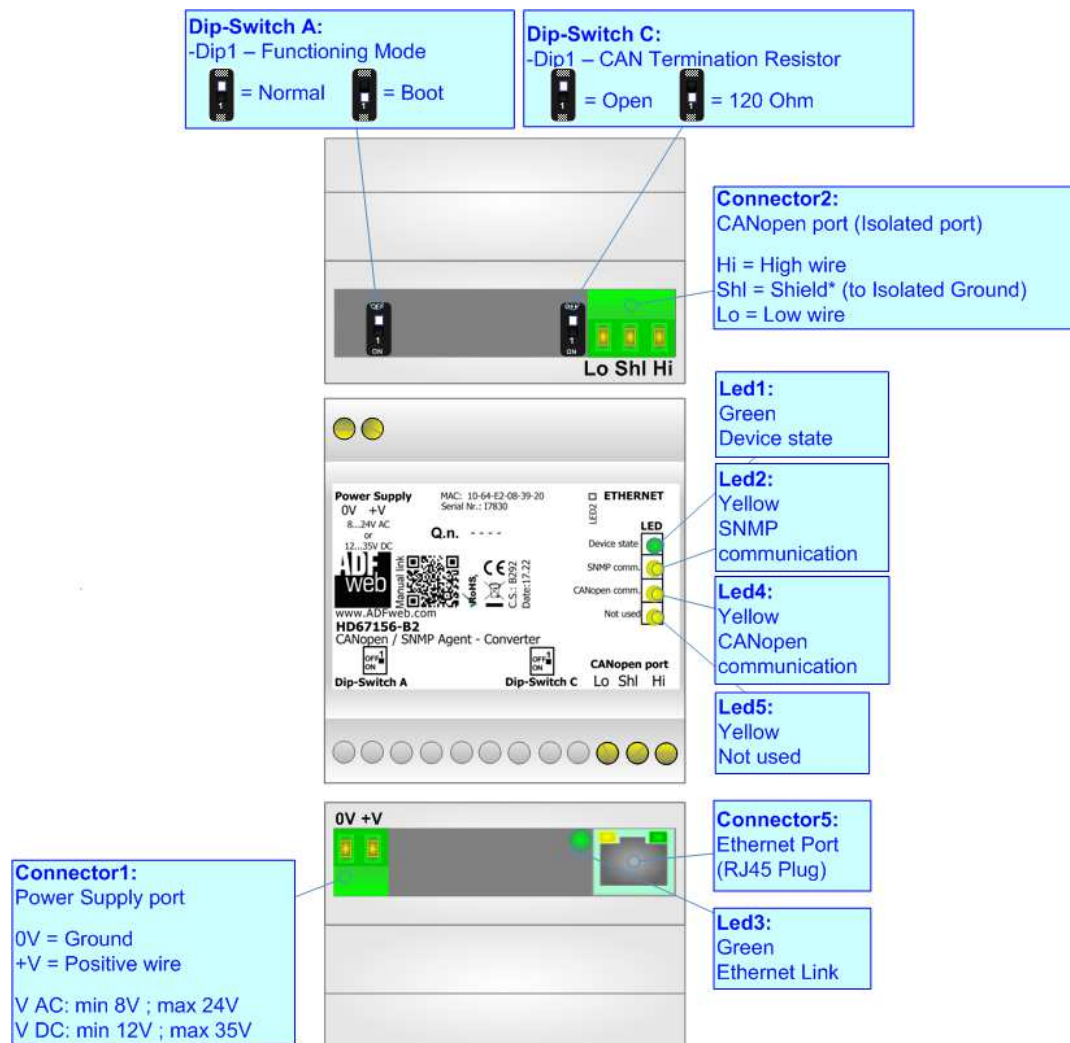

Figure 1b: Connection scheme for HD67156-B2

**CHARACTERISTICS:**

The HD67156-A1 and HD67156-B2 is a SNMP Agent / CANopen - Converter.

It has the following characteristics:

- Up to 1024 bytes in reading and 1024 bytes in writing;
- Triple isolation between CANopen - Power Supply, CANopen - Ethernet, Power Supply - Ethernet.
- Two-directional information between CANopen bus and SNMP bus;
- Mountable on 35mm Rail DIN;
- Wide power supply input range: 8...24V AC or 12...35V DC;
- Wide temperature range: -40°C / 85°C [-40°F / +185°F].

**CONFIGURATION:**

You need Compositor SW67156 software on your PC in order to perform the following:

- Define the parameter of PROFINET line;
- Define the parameter of CAN line;
- Define SDO Server information;
- Define SDO Client information;
- Define PDO information (RPDO/TPDO);
- Define Node Guarding;
- Update the device.

**POWER SUPPLY:**

The devices can be powered at 8...24V AC and 12...35V DC. For more details see the two tables below.

VAC		VDC	
Vmin	Vmax	Vmin	Vmax
8V	24V	12V	35V

Consumption at 24V DC:

Device	Consumption [W/VA]
HD67156-A1	3.5
HD67156-B2	3.5

**Connector1:**  
Power Supply port  
0V = Ground  
+V = Positive wire  
V AC: min 8V ; max 24V  
V DC: min 12V ; max 35V



**Caution: Not reverse the polarity power**

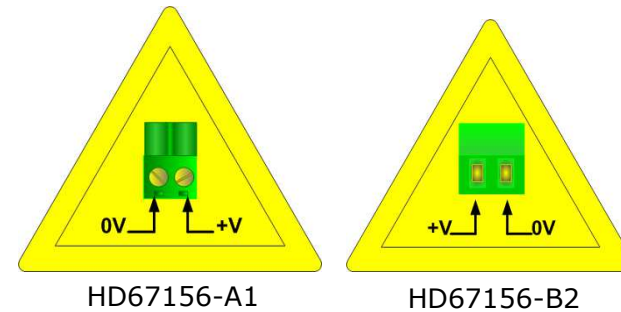

HD67156-A1

HD67156-B2

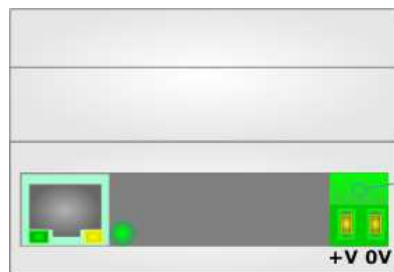

**Connector1:**  
Power Supply port  
0V = Ground  
+V = Positive wire  
V AC: min 8V ; max 24V  
V DC: min 12V ; max 35V



**FUNCTION MODES:**

The device has got two functions mode depending of the position of the 'Dip1 of Dip-Switch A':

- The first, with 'Dip1 of Dip-Switch A' at "OFF" position, is used for the normal working of the device.
- The second, with 'Dip1 of Dip-Switch A' at "ON" position, is used for upload the Project and/or Firmware.

For the operations to follow for the updating, see 'UPDATE DEVICE' section.

According to the functioning mode, the LEDs will have specifics functions, see 'LEDS' section.

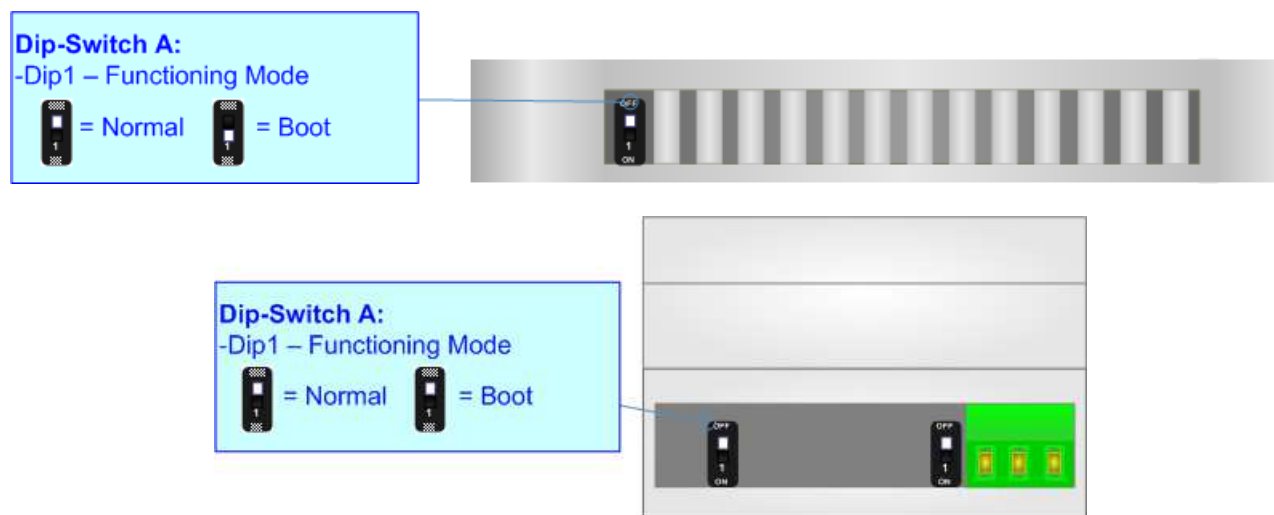

**LEDS:**

The devices has got four (five for HD67156-B2) LEDs that are used to give information of the functioning status. The various meanings of the LEDs are described in the table below.

LED	Normal Mode	Boot Mode
1: Device State	Blinks slowly (~1Hz)	<b>Blinks quickly:</b> Boot state <b>Blinks very slowly (~0.5Hz):</b> update in progress
2: SNMP Communication	Blinks when SNMP frames are received	<b>Blinks quickly:</b> Boot state <b>Blinks very slowly (~0.5Hz):</b> update in progress
3: Ethernet Link	<b>ON:</b> Ethernet cable connected <b>OFF:</b> Ethernet cable disconnected	<b>ON:</b> Ethernet cable connected <b>OFF:</b> Ethernet cable disconnected
4: CANopen Communication	Blinks when CANopen frames are received	<b>Blinks quickly:</b> Boot state <b>Blinks very slowly (~0.5Hz):</b> update in progress
5: Not used (Present only on HD67156-B2)	OFF	<b>Blinks quickly:</b> Boot state <b>Blinks very slowly (~0.5Hz):</b> update in progress

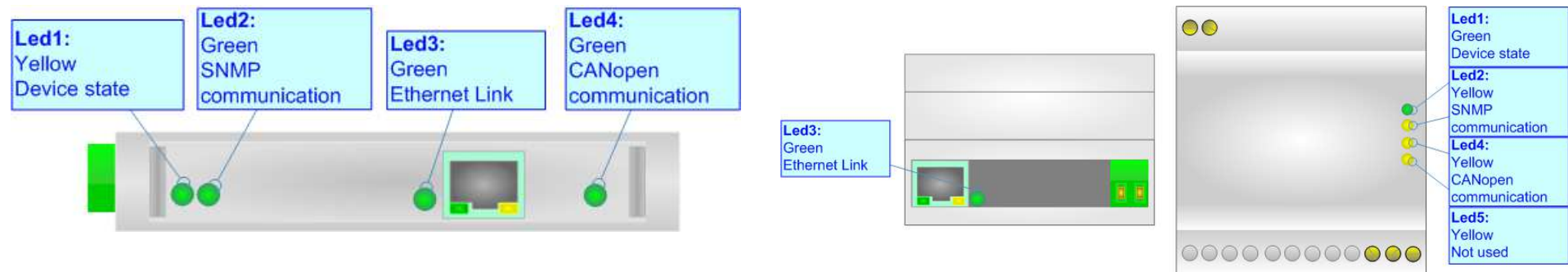

**SNMP:**

The SNMP connection must be made using Connector5 of HD67156-A1/B2 with at least a Category 5E cable. The maximum length of the cable should not exceed 100m. The cable has to conform to the T568 norms relative to connections in cat.5 up to 100 Mbps. To connect the device to an Hub/Switch is recommended the use of a straight cable, to connect the device to a PC/other is recommended the use of a cross cable.

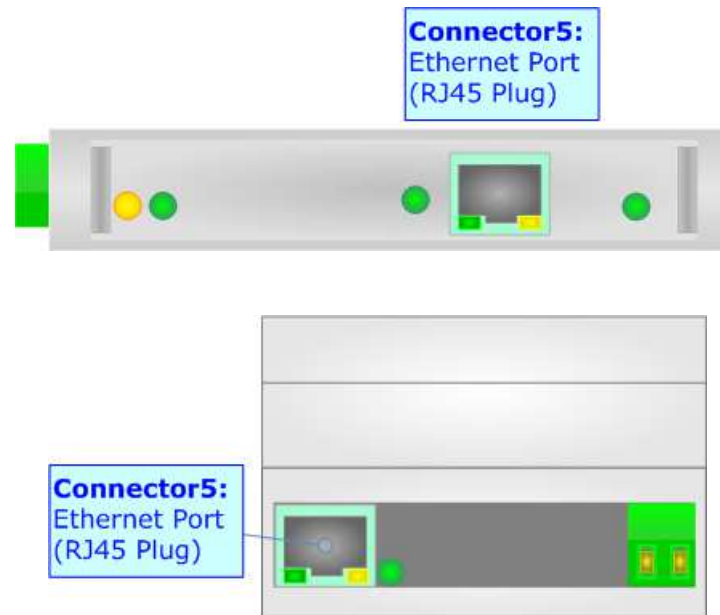

**CAN:**

For terminating the CAN line with a 120Ω resistor it is necessary that the Dip1 of 'Dip-Switch C' is at ON position.

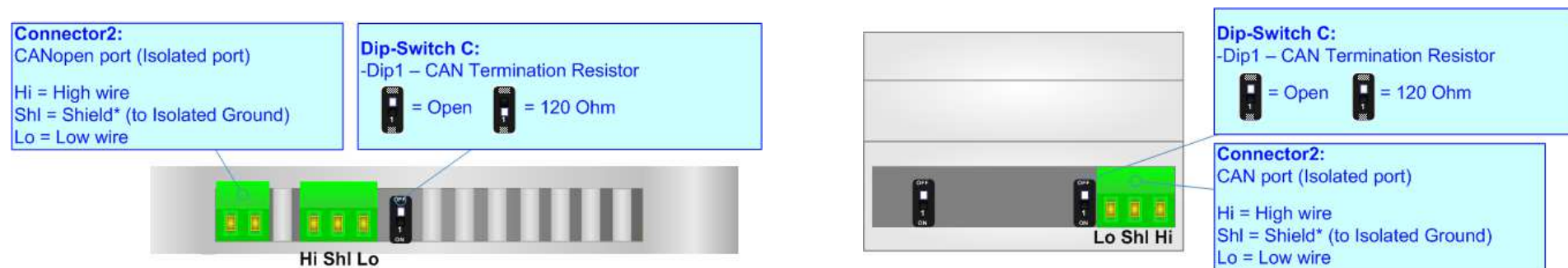

Cable characteristics:

<b>DC parameter:</b>	Impedance	70 Ohm/m
<b>AC parameters:</b>	Impedance	120 Ohm/m
	Delay	5 ns/m
<b>Length</b>	<b>Baud Rate [bps]</b>	<b>Length MAX [m]</b>
	10 K	5000
	20 K	2500
	50 K	1000
	100 K	650
	125 K	500
	250 K	250
	500 K	100
	800 K	50
	1000 K	25

## USE OF COMPOSITOR SW67156:

To configure the Converter, use the available software that runs with Windows called SW67156. It is downloadable on the site [www.adfweb.com](http://www.adfweb.com) and its operation is described in this document. *(This manual is referenced to the last version of the software present on our web site)*. The software works with MSWindows (XP, Vista, Seven, 8, 10, 11; 32/64bit).

When launching the SW67156, the window below appears (Fig. 2).



**Note:**

It is necessary to have installed .Net Framework 4.

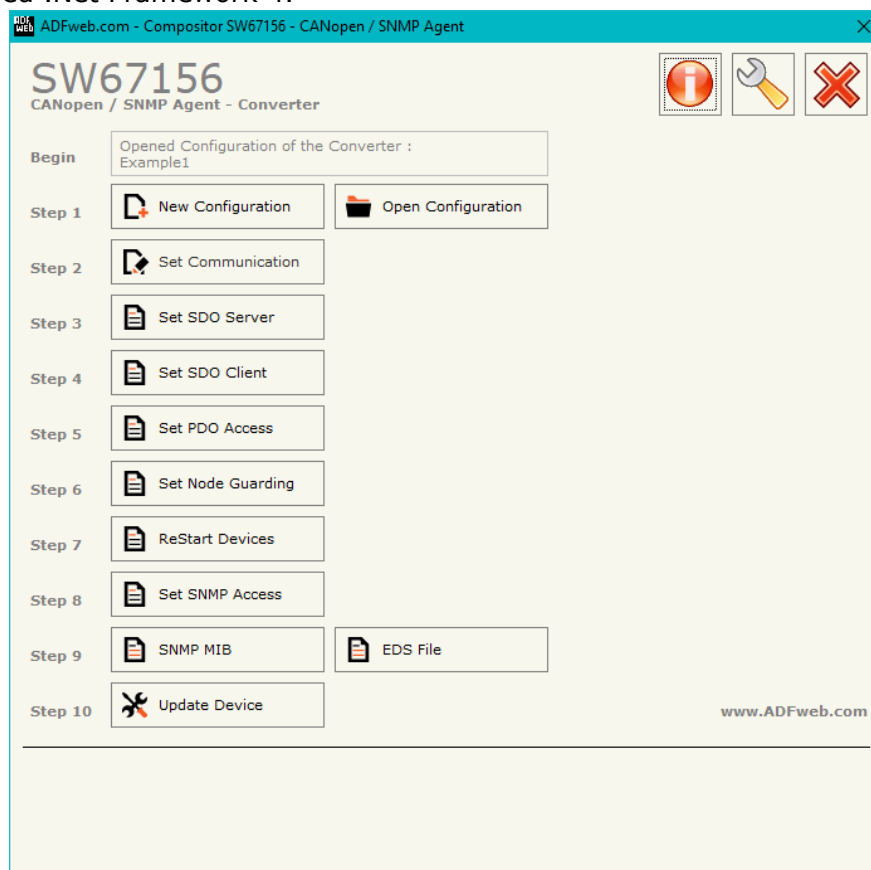
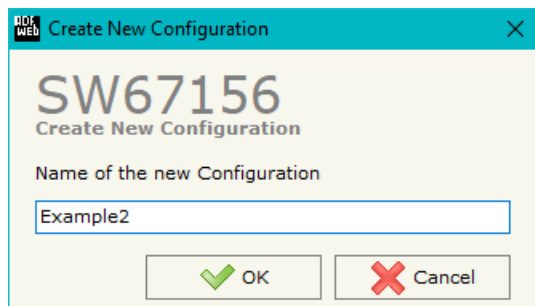

Figure 2: Main window for SW67156

**NEW CONFIGURATION / OPEN CONFIGURATION:**

The “**New Configuration**” button creates the folder which contains the entire device’s configuration.



A device’s configuration can also be imported or exported:

- To clone the configurations of a Programmable “SNMP Agent / CANopen - Converter” in order to configure another device in the same manner, it is necessary to maintain the folder and all its contents;
- To clone a project in order to obtain a different version of the project, it is sufficient to duplicate the project folder with another name and open the new folder with the button “**Open Configuration**”.

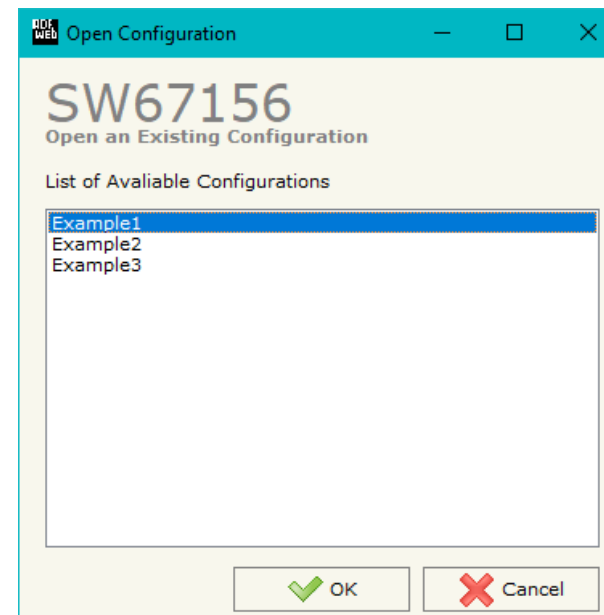

## SOFTWARE OPTIONS:

By pressing the “**Settings**” () button there is the possibility to change the language of the software and check the updatings for the compositor.

In the section “Language” it is possible to change the language of the software.

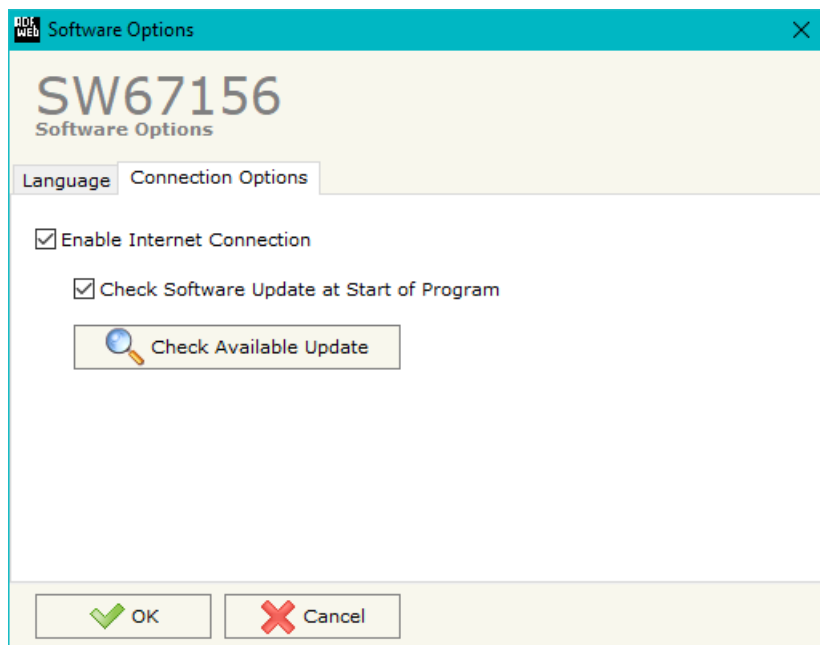

In the section “Connection Options”, it is possible to check if there are some updatings of the software compositor in ADFweb.com website. Checking the option “**Check Software Update at Start of Program**”, the SW67156 check automatically if there are updatings when it is launched.

## SET COMMUNICATION:

This section define the fundamental communication parameters of two buses, SNMP and CANopen.

By Pressing the **"Set Communication"** button from the main window for SW67156 (Fig. 2) the window "Set Communication" appears (Fig. 3).

The window is divided in two sections, one for the SNMP and the other for the CANopen.

The means of the fields for "SNMP" are:

- In the field **"IP ADDRESS"** the IP address of SNMP side of the converter is defined;
- In the field **"SUBNET Mask"** the SubNet Mask of SNMP side of the converter is defined;
- In the field **"GATEWAY"** the default gateway of the network is defined. This feature can be enabled or disabled pressing the Check Box field. This feature is used for going out of the net;
- In the field **"SNMP Name of Station"** the name for SNMP Agent station is defined;
- In the field **"Contact"** the contact for SNMP Agent station is defined;
- In the field **"Location"** the location for SNMP Agent station is defined;
- In the field **"Version"** the version of SNMP is defined;
- If SNMP V3 is used, the following fields must be filled:
  - In the field **"User"** the user for the SNMP authentication is defined;
  - In the field **"Security Level"** the type of security used is defined;
  - In the field **"Authority"** the password for the SNMP authentication is defined;
  - In the field **"Authority Mode"** the mode used for the authentication is defined;
  - In the field **"Privacy"** the password for Privacy authentication is defined;
  - In the field **"Privacy Mode"** the mode used for Privacy is defined;

The means of the fields for the "CAN" section are:

- In the field **"Device ID"** the ID of the CANopen side is defined;
- In the field **"Baudrate"** the data rate of the CANopen line is defined;
- In the field **"Set Operational State at Start-Up"** the state of the CANopen is defined. I.e. If it is checked the board starts in Operational State, else it starts in Pre-Operational;

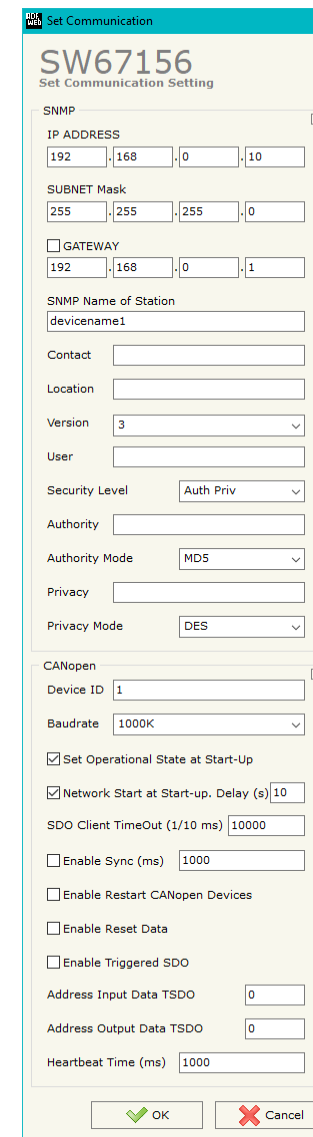

Figure 3: "Set Communication" window



- In the field "**Network Start at Start-Up**" the state of the CANopen network is defined. I.e. If it is checked the board sends a command to set the Operational State of all the devices present in the network, after the time defined in the "Delay" field;
- In the field "**Delay (s)**" the delay before sending the "Start" command for the CANopen is defined;
- In the field "**SDO Client TimeOut (1/10 ms)**" the maximum time that the device attends for the answer from the Slave interrogated is defined;
- If the field "**Enable Sync (ms)**" is checked and a time is defined, the converter can send cyclically a SYNC message to the CANopen network;
- If the field "**Enable Restart CANopen Devices**" is checked, the converter restarts the CANopen devices listed in the section "ReStart Devices" that are not answering to the NodeGuarding;
- If the field "**Enable Reset Data**" is checked, the converter resets data on SNMP side for the CANopen devices that are not answering to NodeGuarding;
- If the field "**Enable Triggered SDO**" is checked, the it is possible to send asynchronous SDO requests directly from SNMP side. The starting input byte of the converter to write for sending the SDO requests is defined in the field "**Address Input Data TSDO**" and the response is saved starting from output byte defined in the field "**Address Output Data TDSO**". See page 35 for more info;
- In the field "**Heartbeat Time (ms)**" the delay between Heartbeat messages is defined.

### SET SDO SERVER:

By pressing the **“Set SDO Server”** button from the main window for SW67156 (Fig. 2) the window **“Set SDO Server Access”** appears (Fig. 4).

This window is made to create the SDO in read or write in the CANopen side, and to indicate which byte are associated to these SDOs.

It is divided in two parts, the **“SDO in read”** and the **“SDO in Write”**.

The first part is used to read, using the SDO, the data arrived from the SNMP Manager. The second is used to write, using SDO, the data that will be sent to the SNMP Manager.

The data of the columns have the following meanings:

- In the field **“Index”** the address of the SDO is defined;
- In the field **“SubIndex”** the second address of the SDO is defined;
- If the field **“N Byte”** the dimension of the SDO is defined (it can be 1, 2 or 4);
- In the field **“Address Byte1”** insert the address of the SNMP array where read/write first byte of the SDO;
- In the field **“Address Byte2”** insert the address of the SNMP array where read/write second byte of the SDO (only if N Byte is 2 or 4);
- In the field **“Address Byte3”** insert the address of the SNMP array where read/write third byte of the SDO (only if N Byte is 4);
- In the field **“Address Byte4”** insert the address of the SNMP array where read/write fourth byte of the SDO (only if N Byte is 4);
- In the field **“Mnemonic”** the description for the SDO is defined.

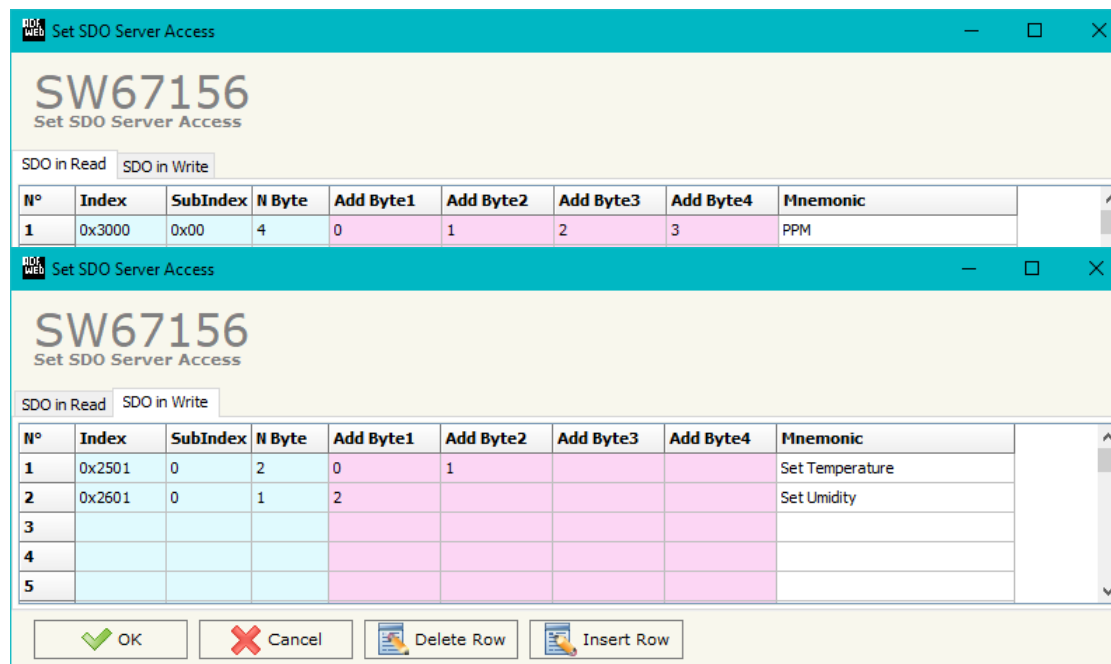

Figure 4: **“Set SDO Server Access”** window

### SET SDO CLIENT:

By pressing the "Set SDO Client" button from the main window for SW67156 (Fig. 2) the window "Set SDO Client Access" appears (Fig. 5a and 5b).

With the SDO Client the HD67156 Gateway can read and/or write the data from other devices connected in the network CANopen.

It is divided in two parts, the "SDO Read" and the "SDO Write". The first part is used to read, using the SDO, the data in another device and then put them in the SNMP array. The second part is used to write, using the SDO, the data present in the SNMP array to others CANopen devices.

The data of the columns in the "SDO Read" have the following meanings:

- In the field "Device ID" insert the ID of the device to read;
- In the field "Index" the address for the SDO is defined;
- In the field "SubIndex" the second address for the SDO is defined;
- In the field "N Byte" the dimension of the SDO is defined (it can be 1, 2, or 4);
- In the field "Poll Time" insert the cyclic time to make this request;
- In the field "Address Byte1" the address of the SNMP array where copying the first byte of the SDO read is defined;
- In the field "Address Byte2" the address of the SNMP array where copying the second byte of the SDO read is defined (only if N Byte is 2 or 4);
- In the field "Address Byte3" the address of the SNMP array where copying the third byte of the SDO read is defined (only if N Byte is 4);
- In the field "Address Byte4" the address of the SNMP array where copying the fourth byte of the SDO read is defined (only if N Byte is 4);
- In the field "Mnemonic" the description for the SDO is defined.

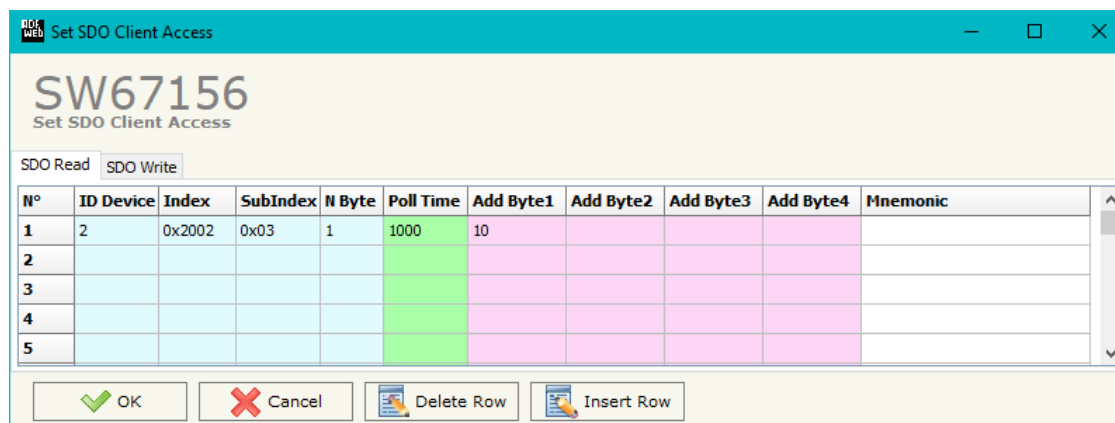

Figure 5a: "Set SDO Client Access – SDO Read" window

The data of the columns in the "SDO Write" have the following meanings:

- In the field "**Device ID**" insert the ID of the device to write;
- In the field "**Index**" the address for the SDO is defined;
- In the field "**SubIndex**" the second address for the SDO is defined;
- In the field "**N Byte**" the dimension of the SDO is defined (it can be 1, 2, or 4);
- In the field "**Poll Time**" insert the cyclic time to make this request;
- If the field "**On Change**" is checked, the gateway sends the Write SDO request when the data change the value;
- In the field "**Address Byte1**" the address of the SNMP array where reading the first byte of the SDO write is defined;
- In the field "**Address Byte2**" the address of the SNMP array where reading the second byte of the SDO write is defined (only if N Byte is 2 or 4);
- In the field "**Address Byte3**" the address of the SNMP array where reading the third byte of the SDO write is defined (only if N Byte is 4);
- In the field "**Address Byte4**" the address of the SNMP array where reading the fourth byte of the SDO write is defined (only if N Byte is 4);
- In the field "**Mnemonic**" the description for the SDO is defined.

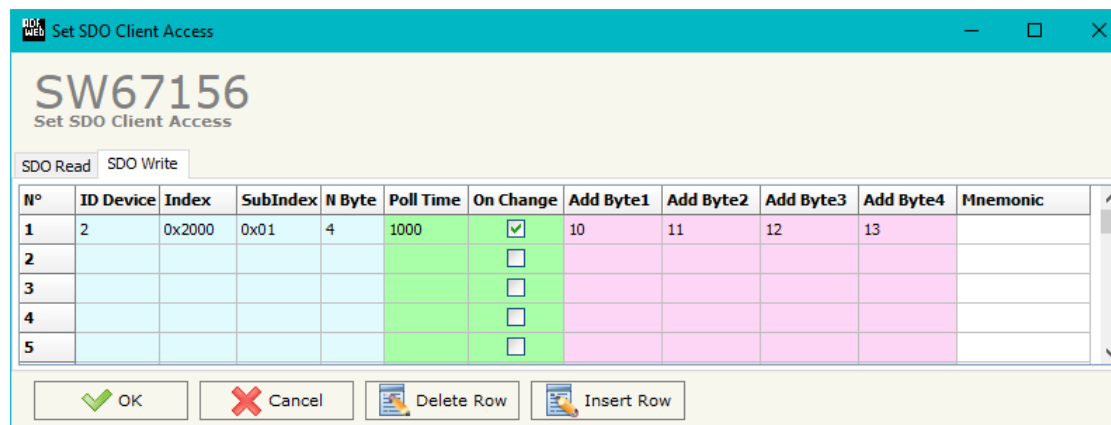

Figure 5b: "Set SDO Client Access – SDO Write" window

### SET PDO ACCESS:

By pressing the "Set PDO Access" button from the main window for SW67156 (Fig. 2) the window "Set PDO Access" appears (Fig. 6a and 6b).

This window is made to create the Receive and the Transmit PDO in the CANopen side, and to indicate which bytes are associated to these PDO.

It is divided in two parts, the "Receive PDO" and the "Transmit PDO". The first part is used to receive PDO in the CANopen network and copy the data in the SNMP array. The second part is used to transmit PDO in the CANopen network with the data of SNMP array.

The data of the columns in the "Receive PDO" have the following meanings:

- In the Field "**Cob-ID**" the address for the PDO is defined;
- In the Field "**Dimension**" the dimension of the PDO is defined (it can be between 1 and 8);
- In the Field "**Add B1**" the first byte where the data will be saved in the SNMP array is defined;
- In the Field "**Add B2**" the second byte where the data will be saved in the SNMP array is defined (only if **Dimension** > 1);
- In the Field "**Add B3**" the third byte where the data will be saved in the SNMP array is defined (only if **Dimension** > 2);
- In the Field "**Add B4**" the fourth byte where the data will be saved in the SNMP array is defined (only if **Dimension** > 3);
- In the Field "**Add B5**" the fifth byte where the data will be saved in the SNMP array is defined (only if **Dimension** > 4);
- In the Field "**Add B6**" the sixth byte where the data will be saved in the SNMP array is defined (only if **Dimension** > 5);
- In the Field "**Add B7**" the seventh byte where the data will be saved in the SNMP array is defined (only if **Dimension** > 6);
- In the Field "**Add B8**" the eighth byte where the data will be saved in the SNMP array is defined (only if **Dimension** > 7);
- The field "**TimeOut**" is used for put at zero the data into SNMP if the PDO doesn't arrive with a frequency less than the time expressed in the field. If the value in the field is 0, it means that you don't want to use this feature, and so the value is never deleted;
- In the field "**Mnemonic**" the description for the PDO is defined.

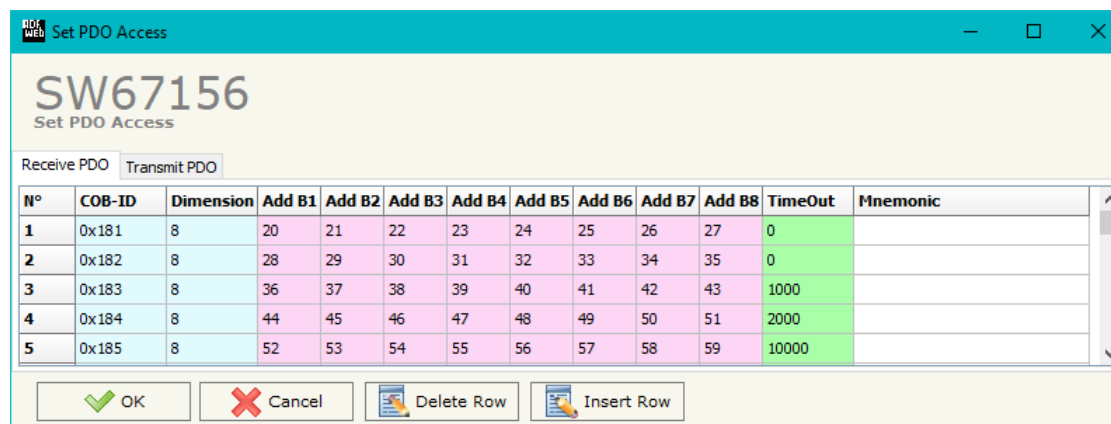

N°	COB-ID	Dimension	Add B1	Add B2	Add B3	Add B4	Add B5	Add B6	Add B7	Add B8	TimeOut	Mnemonic
1	0x181	8	20	21	22	23	24	25	26	27	0	
2	0x182	8	28	29	30	31	32	33	34	35	0	
3	0x183	8	36	37	38	39	40	41	42	43	1000	
4	0x184	8	44	45	46	47	48	49	50	51	2000	
5	0x185	8	52	53	54	55	56	57	58	59	10000	

Figure 6a: "Set PDO Access – Receive PDO" window

The data of the columns in the "Transmit PDO" have the following meanings:

- In the Field "**Cob-ID**" the address for the PDO is defined;
- In the Field "**Dimension**" the dimension of the PDO is defined (it can be between 1 and 8);
- In the Field "**Add B1**" the first byte where the data will be loaded in the SNMP array is defined;
- In the Field "**Add B2**" the second byte where the data will be loaded in the SNMP array is defined (only if **Dimension** > 1);
- In the Field "**Add B3**" the third byte where the data will be loaded in the SNMP array is defined (only if **Dimension** > 2);
- In the Field "**Add B4**" the fourth byte where the data will be loaded in the SNMP array is defined (only if **Dimension** > 3);
- In the Field "**Add B5**" the fifth byte where the data will be loaded in the SNMP array is defined (only if **Dimension** > 4);
- In the Field "**Add B6**" the sixth byte where the data will be loaded in the SNMP array is defined (only if **Dimension** > 5);
- In the Field "**Add B7**" the seventh byte where the data will be loaded in the SNMP array is defined (only if **Dimension** > 6);
- In the Field "**Add B8**" the eighth byte where the data will be loaded in the SNMP array is defined (only if **Dimension** > 7);
- In the Field "**Send Time**" insert the interval used to send the PDO. The time is in milliseconds;
- If the field "**On Change**" is checked, the gateway send the Transmit PDO when the data change the value;
- In the field "**Mnemonic**" the description for the PDO is defined.

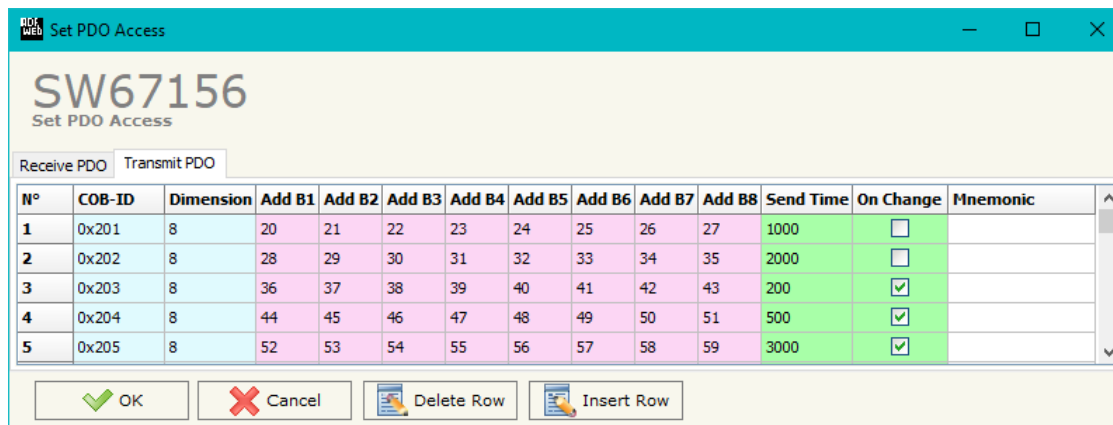
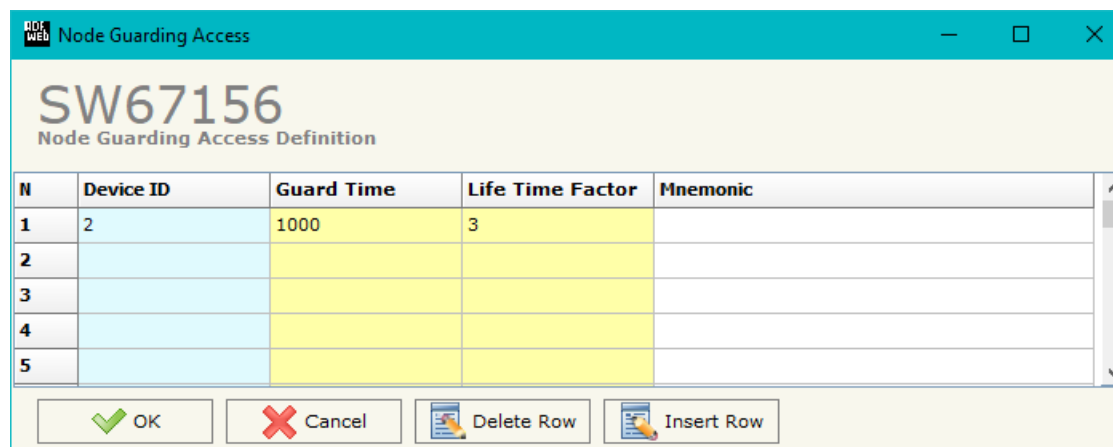

Figure 6b: "Set PDO Access – Transmit PDO" window

**SET NODE GUARDING**

N	Device ID	Guard Time	Life Time Factor	Mnemonic
1	2	1000	3	
2				
3				
4				
5				

Figure 7: "Node Guarding Access Definition" window

By pressing the "**Set Node Guarding**" button from the Main Window of SW67156 (Fig. 2) the "Node Guarding Access Definition" window appears (Fig. 7).

The data of the columns have the following meanings:

- In the field "**Device ID**" the address of the device that you want to control is defined;
- In the field "**Guard Time**" the Guard Time is defined. This value indicates the delay between two interrogations;
- In the field "**Life Time Factor**" the number of attempts before considering the device absent is defined;
- In the field "**Mnemonic**" a description is defined.

**RESTART DEVICES**

Figure 8: "ReStart CANopen Devices" window

By pressing the "ReStart Devices" button from the Main Window of SW67156 (Fig. 2) the "ReStart CANopen Devices" window appears (Fig. 8). This section is used to define which CANopen devices the converter will try to restart if they are not responding to Node Guard.

The data of the columns have the following meanings:

- In the field "Enable ReStart" it is possible to select which CANopen devices the converter will restart;
- In the field "Mnemonic" a description is defined.

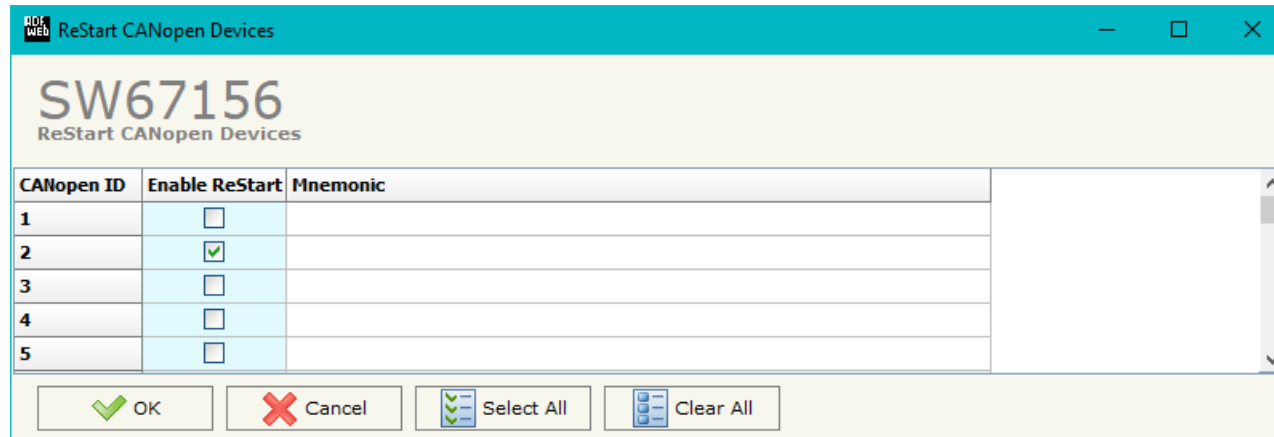

**SET SNMP ACCESS:**

By pressing the "Set SNMP Access" button from the main window for SW67156 (Fig. 2) the "Set SNMP Access" window appears (Fig. 9). In this section, it is possible to create the OIDs for SNMP side to read or write using GET and SET commands or to be sent as TRAP messages. The window is divided into two tables, one for SNMP readings and one for SNMP writings.

The data of the columns in the "SNMP Read" have the following meanings:

- If the field "Enable" is checked, the SNMP OID is enabled;
- In the field "Community Name" the name of the Community is defined;
- In the field "Type" the type of data of the OID is defined (Octet String or Integer);
- If the field "On Change" is checked, the OID is sent as Trap when the data from MQTT side change;
- If the field "On CMD" is checked, the OID is sent as Trap when the a MQTT message is received;
- If the field "On Timer" is checked, the OID is sent as Trap cyclically;
- In the field "Time (ms)" the delay time for the Trap send is defined (if "On Timer" option is checked);
- In the field "Position" the starting byte of the internal memory array where taking the data is defined;
- In the field "Start Bit" the starting bit of the selected Position is defined;
- In the field "Num Bits/Bytes" the dimension of the OID is defined. For 'Int' type the dimension is in bit, for 'String' type the dimension is in bytes;
- In the field "Description" the description/name of the OID is defined;
- In the field "IP Address" the IP Address of the SNMP device where addressing the Trap message is defined. This field is used only when 'On Change' or 'On Timer' option is checked;
- In the field "Conversion" it is possible to select the data conversion to apply to the data (Float to Int);
- In the field "Mnemonic" a brief description of the OID is defined.



Figure 9a: "Set SNMP Access -> SNMP Read" window

The data of the columns in the "SNMP Write" have the following meanings:

- If the field "Enable" is checked, the SNMP OID is enabled;
- In the field "Community Name" the name of the Community is defined;
- In the field "Type" the type of data of the OID is defined (Octet String or Integer);
- In the field "Position" the starting byte of the internal memory array where mapping the data is defined;
- In the field "Start Bit" the starting bit of the selected Position is defined;
- In the field "Num Bits/Bytes" the dimension of the OID is defined. For 'Int' type the dimension is in bit, for 'String' type the dimension is in bytes;
- In the field "Description" the description/name of the OID is defined;
- In the field "Conversion" it is possible to select the data conversion to apply to the data (Int to Float);
- In the field "Mnemonic" a brief description of the OID is defined.

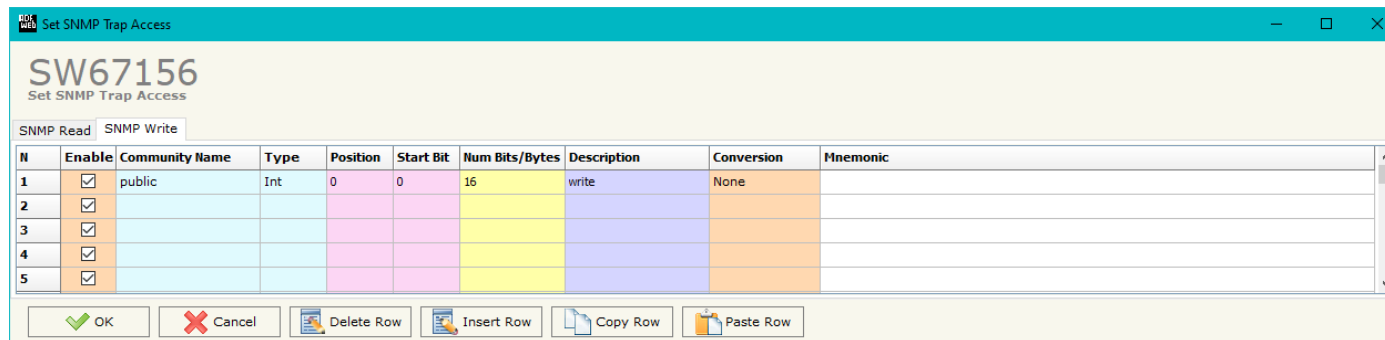

N	Enable	Community Name	Type	Position	Start Bit	Num Bits/Bytes	Description	Conversion	Mnemonic
1	<input checked="" type="checkbox"/>	public	Int	0	0	16	write	None	
2	<input checked="" type="checkbox"/>								
3	<input checked="" type="checkbox"/>								
4	<input checked="" type="checkbox"/>								
5	<input checked="" type="checkbox"/>								

Figure 9b: "Set SNMP Access -> SNMP Write" window

 **Note:** If the fields "On Change" and "On Timer" are disabled, the OID is readable using standard GET command. If one of these fields is enabled, the OID is sent as Trap and it is readable by GET command too.

 **Note:** The field "Description" must start with lowercase letter and it cannot contain special chars (just letters and numbers). All the "Description" fields must be different between them.

**SNMP MIB:**

By pressing the "**SNMP MIB**" button it is possible to save the MIB file for the SNMP Manager.

**EDS FILE:**

By Pressing the "**EDS FILE**" button from the main window for SW67607 (Fig. 2) it is possible to generate the EDS file to be imported into the master CANopen.

**UPDATE DEVICE:**

By pressing the **"Update Device"** button, it is possible to load the created Configuration into the device; and also the Firmware, if necessary.

If you don't know the actual IP address of the device you have to use this procedure:

- Turn OFF the Device;
- Put Dip1 of 'Dip-Switch A' in ON position;
- Turn on the device
- Connect the Ethernet cable;
- Insert the IP **"192.168.2.205"**;
- Press the **"Ping"** button, "Device Found!" must appear;
- Press the **"Next"** button;
- Select which operations you want to do;
- Press the **"Execute update firmware"** button to start the upload;
- When all the operations are "OK" turn off the Device;
- Put Dip1 of 'Dip-Switch A' at OFF position;
- Turn ON the device.

If you know the actual IP address of the device, you have to use this procedure:

- Turn on the Device with the Ethernet cable inserted;
- Insert the actual IP of the Converter;
- Press the **"Ping"** button, must appear "Device Found!";
- Press the **"Next"** button;
- Select which operations you want to do;
- Press the **"Execute update firmware"** button to start the upload;
- When all the operations are "OK" the device automatically goes at Normal Mode.

At this point the configuration/firmware on the device is correctly update.

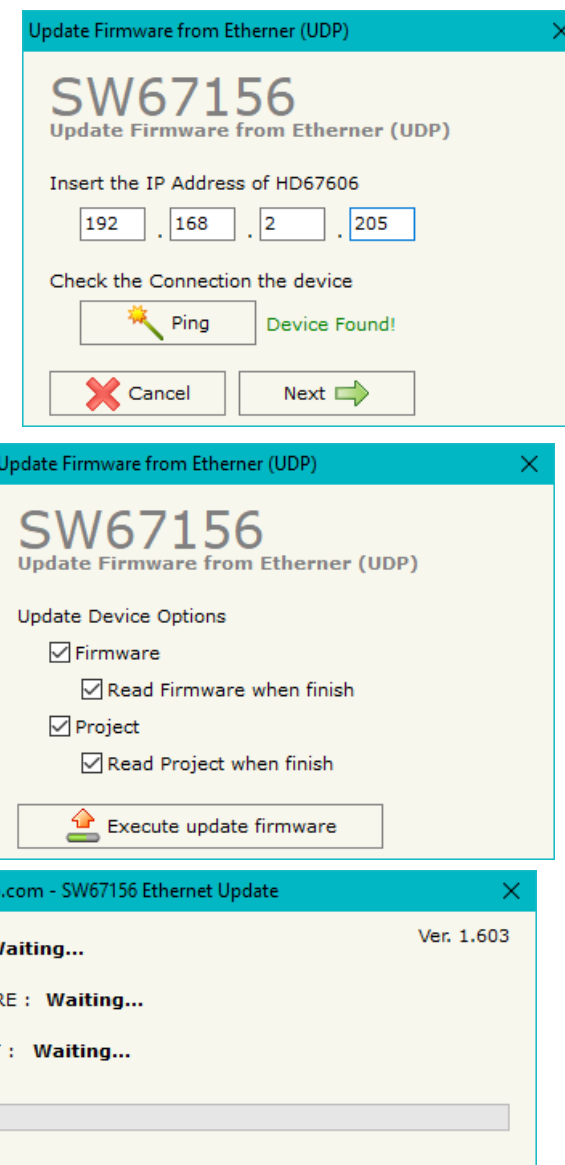





Figure 10: "Update device" windows

 **Note:**  
When you install a new version of the software, if it is the first time it is better you do the update of the Firmware in the HD67156-A1/B2 device.

 **Note:**  
When you receive the device, for the first time, you also have to update the Firmware in the HD67156-A1/B2 device.

 **Warning:**  
If Fig. 11 appears when you try to do the Update try these points before seeking assistance:

- Try to repeat the operations for the updating;
- Try with another PC;
- Try to restart the PC;
- Check the LAN settings;
- If you are using the program inside a Virtual Machine, try to use in the main Operating System;
- If you are using Windows Seven, Vista, 8 or 10 make sure that you have the administrator privileges;
- In case you have to program more than one device, using the "UDP Update", you have to cancel the ARP table every time you connect a new device on Ethernet. For do this you have to launch the "Command Prompt" and write the command "arp -d". Pay attention that with Windows Vista, Seven, 8, 10 you have to launch the "Command Prompt" with Administrator Rights;
- Pay attention at Firewall lock.

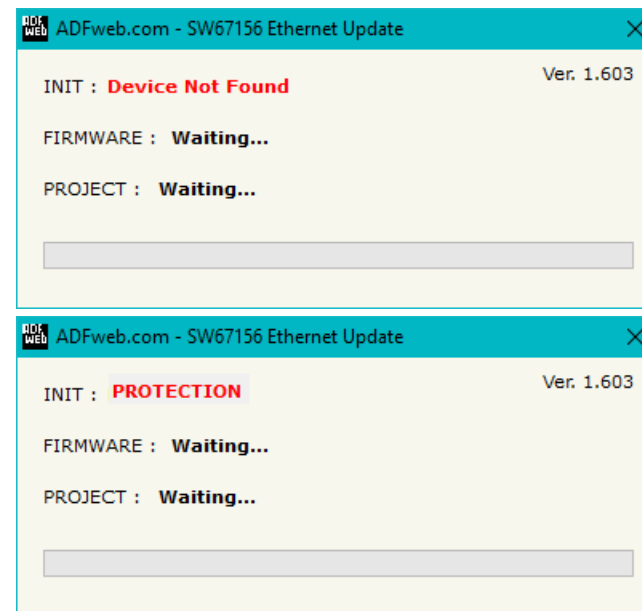

Figure 11: "Error" window

 In the case of HD67156-A1/B2 you have to use the software "SW67156": [www.adfweb.com/download/filefold/SW67156.zip](http://www.adfweb.com/download/filefold/SW67156.zip).

## SNMP COMMUNICATION

In order to read/write the data from/to CANopen side, it is necessary to use specific SNMP commands in order to see the SNMP Input and write the SNMP Output.

### Reading CAN data from SNMP:

In order to read the data from the HD67156-A1/B2, it is necessary to use the GET command. Each OID defined in the section "Set SNMP Access -> SNMP Read" will be placed in the MIB tree of the converter.

In addition, it will be possible to read the entire internal map of the converter in memory blocks of 128 bytes: this feature is helpful in phase of configuration of the converter.

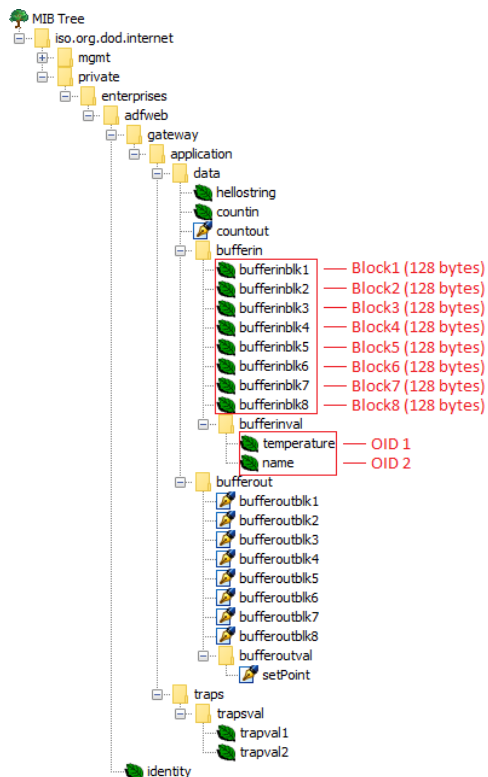

Each SNMP variable created will have its own OID and it will be created following this rule:

- OID 1 (first row of "Set SNMP Access -> SNMP Read" table): **.1.3.6.1.4.1.49314.1.1.1.4.9.1**
- OID 2 (second row of "Set SNMP Access -> SNMP Read" table): **.1.3.6.1.4.1.49314.1.1.1.4.9.2**
- OID X (Xth row of "Set SNMP Access -> SNMP Read" table): **.1.3.6.1.4.1.49314.1.1.1.4.9.X**

The memory blocks are accessible with these OIDs:

- Block1: **.1.3.6.1.4.1.49314.1.1.1.4.1.0**
- Block2: **.1.3.6.1.4.1.49314.1.1.1.4.2.0**
- Block3: **.1.3.6.1.4.1.49314.1.1.1.4.3.0**
- Block4: **.1.3.6.1.4.1.49314.1.1.1.4.4.0**
- Block5: **.1.3.6.1.4.1.49314.1.1.1.4.5.0**
- Block6: **.1.3.6.1.4.1.49314.1.1.1.4.6.0**
- Block7: **.1.3.6.1.4.1.49314.1.1.1.4.7.0**
- Block8: **.1.3.6.1.4.1.49314.1.1.1.4.8.0**

Writing CAN data from SNMP:

In order to write the data from the HD67156-A1/B2, it is necessary to use the SET command.  
 Each OID defined in the section "Set SNMP Access -> SNMP Write" will be placed in the MIB tree of the converter.

In addition, it will be possible to write the entire internal map of the converter in memory blocks of 128 bytes: this feature is helpful in phase of configuration of the converter.

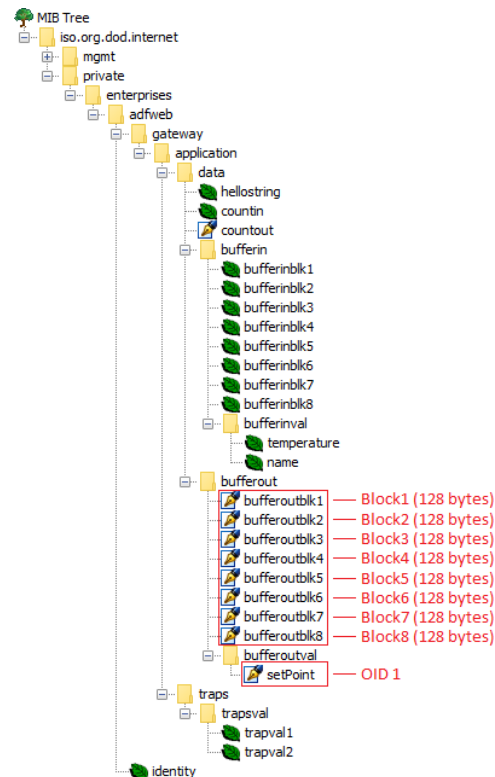



Each SNMP variable created will have its own OID and it will be created following this rule:

- ➔ OID 1 (first row of "Set SNMP Access -> SNMP Write" table): **.1.3.6.1.4.1.49314.1.1.1.5.9.1**
- ➔ OID 2 (second row of "Set SNMP Access -> SNMP Write" table): **.1.3.6.1.4.1.49314.1.1.1.5.9.2**
- ➔ OID X (Xth row of "Set SNMP Access -> SNMP Write" table): **.1.3.6.1.4.1.49314.1.1.1.5.9.X**

The memory blocks are accessible with these OIDs:

- ➔ Block1: .1.3.6.1.4.1.49314.1.1.1.5.1.0
- ➔ Block2: .1.3.6.1.4.1.49314.1.1.1.5.2.0
- ➔ Block3: .1.3.6.1.4.1.49314.1.1.1.5.3.0
- ➔ Block4: .1.3.6.1.4.1.49314.1.1.1.5.4.0
- ➔ Block5: .1.3.6.1.4.1.49314.1.1.1.5.5.0
- ➔ Block6: .1.3.6.1.4.1.49314.1.1.1.5.6.0
- ➔ Block7: .1.3.6.1.4.1.49314.1.1.1.5.7.0
- ➔ Block8: .1.3.6.1.4.1.49314.1.1.1.5.8.0



**Note:**

The OIDs in writing are readable too with GET command.

TRAP messages from SNMP:

All the OIDs defined in the "Set SNMP Access -> SNMP Read" table can be sent as TRAP messages too.

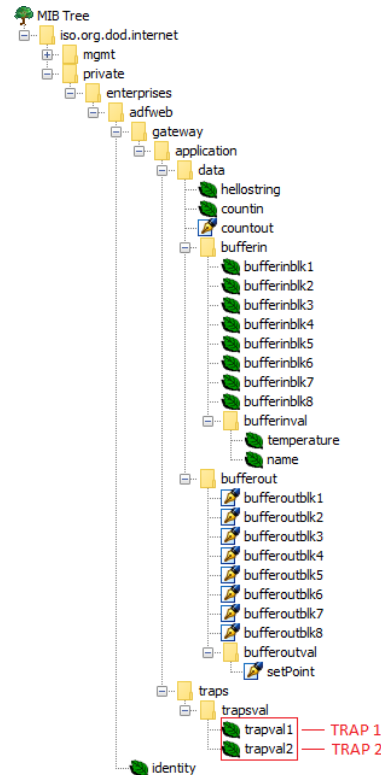

The TRAP messages are contained in the MIB tree and they have these OIDs:

- TRAP 1 (first row of "Set SNMP Access -> SNMP Read" table): **.1.3.6.1.4.1.49314.1.1.2.1.1**
- TRAP 2 (second row of "Set SNMP Access -> SNMP Read" table): **.1.3.6.1.4.1.49314.1.1.2.1.2**
- TRAP X (Xth row of "Set SNMP Access -> SNMP Read" table): **.1.3.6.1.4.1.49314.1.1.2.1.X**

### ASYNCR SDO REQUESTS:

The converter allows to send asynchronous SDO requests directly from SNMP to CANopen. This function can be enabled by checking the option "Enable Triggered SDO" in the section "Set Communication".

It is necessary to write the bytes of SNMP blocks starting from the first byte defined in the field "Address Output Data TDSO" in this way:

Byte Number	Description
1	Counter (increased to send the new CAN message)
2	ID of the CANopen node to interrogate
3÷4	Index of SDO
5	SubIndex of SDO
6÷9	Data to write (set to '0' in case of reading request)
10	Most Significant bit → 0: W; 1: R Bit 6, 5, 4, 3, 2, 1, 0 → Number of bytes to write

The feedback of the SDO request is saved from the first byte defined in the field "Address Input Data TDSO" in this way:

Byte Number	Description
1÷4	Data read (in case of reading)
5	Status of request (1 → OK; 2 → Not OK)

**MECHANICAL DIMENSIONS:**

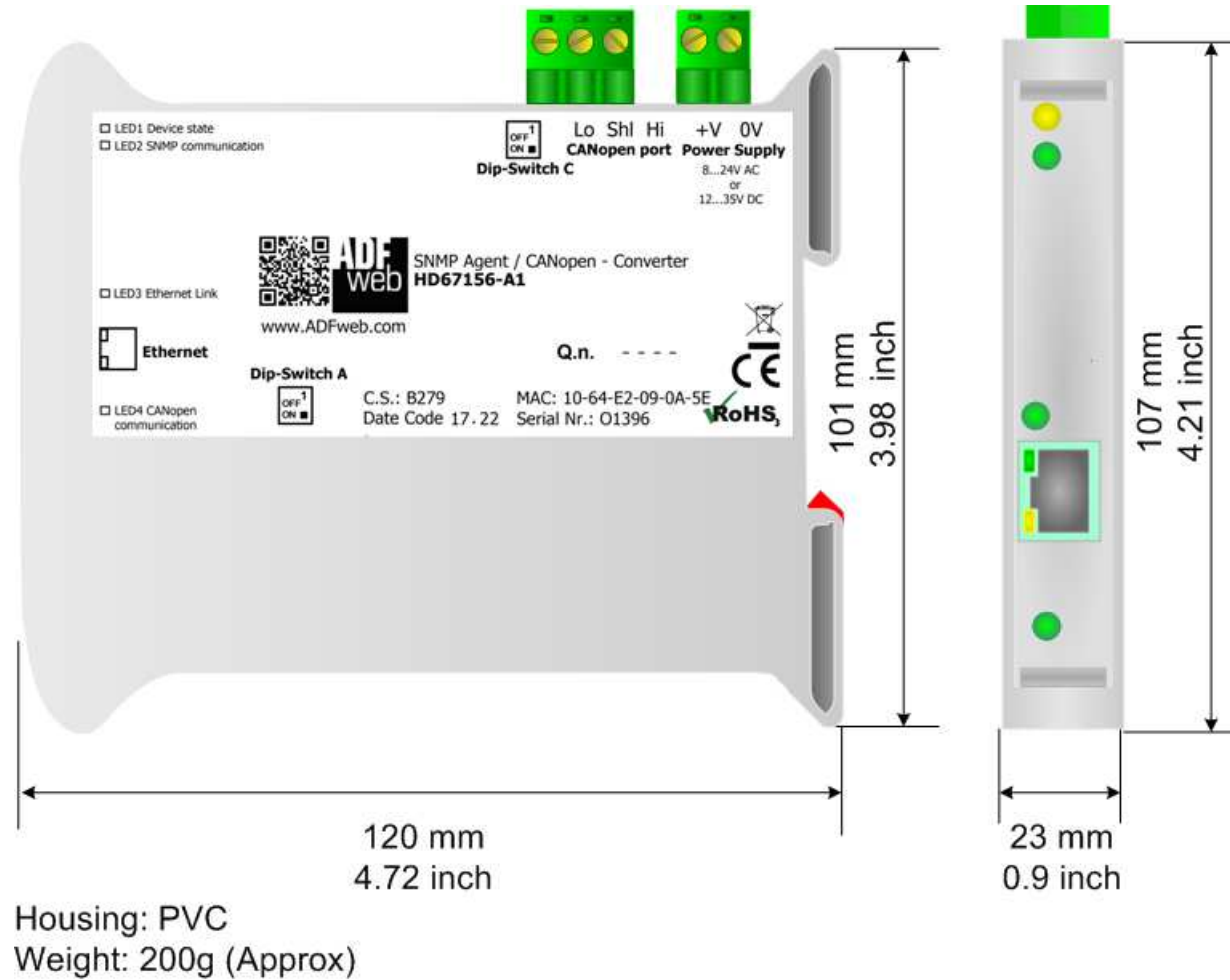
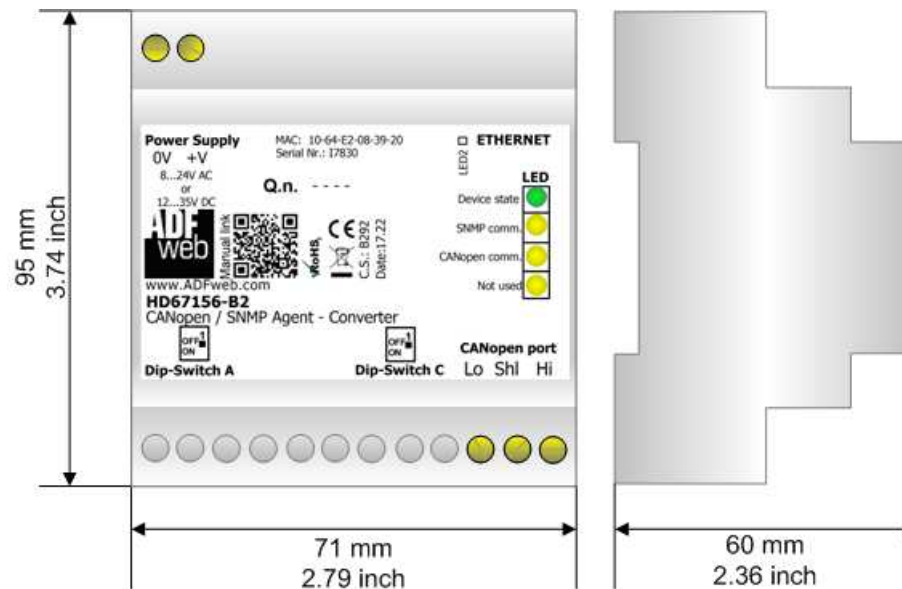

Figure 12a: Mechanical dimensions scheme for HD67156-A1



Housing: PVC  
Weight: 200g (Approx)

Figure 12b: Mechanical dimensions scheme for HD67156-B2

### ORDERING INFORMATIONS:

The ordering part number is formed by a valid combination of the following:

**HD67156 - x x**

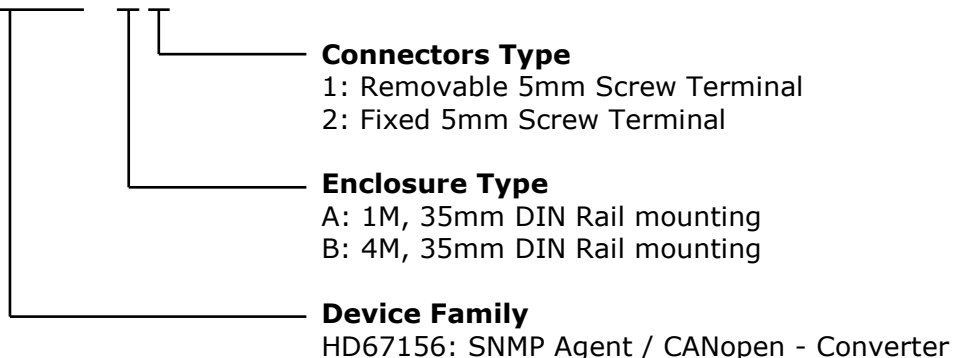

Order Code: **HD67156-A1** - SNMP Agent / CANopen - Converter ( Housing type: A, Terminal Blocks Connectors )

Order Code: **HD67156-B2** - SNMP Agent / CANopen - Converter ( Housing type: B, Terminal Blocks Connectors )

### ACCESSORIES:

Order Code: **AC34011** - 35mm Rail DIN - Power Supply 220/240V AC 50/60Hz - 12 V DC

Order Code: **AC34012** - 35mm Rail DIN - Power Supply 220/240V AC 50/60Hz - 24 V DC

**DISCLAIMER:**

All technical content within this document can be modified without notice. The content of the document is a under continual renewal. For losses due to fire, earthquake, third party access or other accidents, or intentional or accidental abuse, misuse, or use under abnormal conditions repairs are charged to the user. ADFweb.com S.r.l. will not be liable for accidental loss of use or inability to use this product, such as loss of business income. ADFweb.com S.r.l. shall not be liable for consequences of improper use.

**OTHER REGULATIONS AND STANDARDS:****WEEE INFORMATION**

Disposal of old electrical and electronic equipment (as in the European Union and other European countries with separate collection systems).

— This symbol on the product or on its packaging indicates that this product may not be treated as household rubbish. Instead, it should be taken to an applicable collection point for the recycling of electrical and electronic equipment. If the product is disposed correctly, you will help prevent potential negative environmental factors and impact of human health, which could otherwise be caused by inappropriate disposal. The recycling of materials will help to conserve natural resources. For more information about recycling this product, please contact your local city office, your household waste disposal service or the shop where you purchased the product.

**RESTRICTION OF HAZARDOUS SUBSTANCES DIRECTIVE**

The device respects the 2002/95/EC Directive on the restriction of the use of certain hazardous substances in electrical and electronic equipment (commonly referred to as Restriction of Hazardous Substances Directive or RoHS).

**CE MARKING**

The product conforms with the essential requirements of the applicable EC directives.

**WARRANTIES AND TECHNICAL SUPPORT:**

For fast and easy technical support for your ADFweb.com SRL products, consult our internet support at [www.adfweb.com](http://www.adfweb.com).  
Otherwise contact us at the address [support@adfweb.com](mailto:support@adfweb.com)

**RETURN POLICY:**

If while using your product you have any problem and you wish to exchange or repair it, please do the following:

- Obtain a Product Return Number (PRN) from our internet support at [www.adfweb.com](http://www.adfweb.com). Together with the request, you need to provide detailed information about the problem.
- Send the product to the address provided with the PRN, having prepaid the shipping costs (shipment costs billed to us will not be accepted).

If the product is within the warranty of twelve months, it will be repaired or exchanged and returned within three weeks. If the product is no longer under warranty, you will receive a repair estimate.



**ADFweb.com S.r.l.**  
Via Strada Nuova, 17  
IT-31010 Mareno di Piave  
TREVISO (Italy)  
Phone +39.0438.30.91.31  
Fax +39.0438.49.20.99  
[www.adfweb.com](http://www.adfweb.com)

