

# User Manual

Revision 1.000  
English

## CAN / SNMP Manager - Converter

(Order Code: HD67171-A1, HD67171-B2)

for Website information:

[www.adfweb.com?Product=HD67171](http://www.adfweb.com?Product=HD67171)

for Price information:

[www.adfweb.com?Price=HD67171-A1](http://www.adfweb.com?Price=HD67171-A1)

[www.adfweb.com?Price=HD67171-B2](http://www.adfweb.com?Price=HD67171-B2)

### Benefits and Main Features:

- ⊕ Very easy to configure
- ⊕ Electrical isolation
- ⊕ Temperature range: -40°C/85°C (-40°F/185°F)



User Manual

For others SNMP Manager products, see also the following links:

#### Converter SNMP to

[www.adfweb.com?Product=HD67B47](http://www.adfweb.com?Product=HD67B47)  
[www.adfweb.com?Product=HD67D40](http://www.adfweb.com?Product=HD67D40)  
[www.adfweb.com?Product=HD67E24](http://www.adfweb.com?Product=HD67E24)  
[www.adfweb.com?Product=HD67041](http://www.adfweb.com?Product=HD67041)  
[www.adfweb.com?Product=HD67092](http://www.adfweb.com?Product=HD67092)  
[www.adfweb.com?Product=HD67156](http://www.adfweb.com?Product=HD67156)  
[www.adfweb.com?Product=HD67159](http://www.adfweb.com?Product=HD67159)  
[www.adfweb.com?Product=HD67160](http://www.adfweb.com?Product=HD67160)  
[www.adfweb.com?Product=HD67161](http://www.adfweb.com?Product=HD67161)  
[www.adfweb.com?Product=HD67162](http://www.adfweb.com?Product=HD67162)  
[www.adfweb.com?Product=HD67163](http://www.adfweb.com?Product=HD67163)  
[www.adfweb.com?Product=HD67164](http://www.adfweb.com?Product=HD67164)  
[www.adfweb.com?Product=HD67165](http://www.adfweb.com?Product=HD67165)  
[www.adfweb.com?Product=HD67166](http://www.adfweb.com?Product=HD67166)  
[www.adfweb.com?Product=HD67167](http://www.adfweb.com?Product=HD67167)  
[www.adfweb.com?Product=HD67168](http://www.adfweb.com?Product=HD67168)  
[www.adfweb.com?Product=HD67169](http://www.adfweb.com?Product=HD67169)  
[www.adfweb.com?Product=HD67170](http://www.adfweb.com?Product=HD67170)  
[www.adfweb.com?Product=HD67172](http://www.adfweb.com?Product=HD67172)  
[www.adfweb.com?Product=HD67173](http://www.adfweb.com?Product=HD67173)  
[www.adfweb.com?Product=HD67174](http://www.adfweb.com?Product=HD67174)  
[www.adfweb.com?Product=HD67176](http://www.adfweb.com?Product=HD67176)  
[www.adfweb.com?Product=HD67177](http://www.adfweb.com?Product=HD67177)  
[www.adfweb.com?Product=HD67178](http://www.adfweb.com?Product=HD67178)  
[www.adfweb.com?Product=HD67613](http://www.adfweb.com?Product=HD67613)  
[www.adfweb.com?Product=HD67693](http://www.adfweb.com?Product=HD67693)  
[www.adfweb.com?Product=HD67726](http://www.adfweb.com?Product=HD67726)  
[www.adfweb.com?Product=HD67753](http://www.adfweb.com?Product=HD67753)  
[www.adfweb.com?Product=HD67820](http://www.adfweb.com?Product=HD67820)  
[www.adfweb.com?Product=HD67849](http://www.adfweb.com?Product=HD67849)  
[www.adfweb.com?Product=HD67953](http://www.adfweb.com?Product=HD67953)  
[www.adfweb.com?Product=HD67986](http://www.adfweb.com?Product=HD67986)

**(OPC UA Server)**  
**(LoRaWAN)**  
**(EtherCAT)**  
**(DMX)**  
**(M-Bus Wireless)**  
**(CANopen)**  
**(EtherNet/IP)**  
**(DeviceNet Master)**  
**(DeviceNet Slave)**  
**(J1939)**  
**(M-Bus Master)**  
**(Modbus Master)**  
**(Modbus Slave)**  
**(Modbus TCP Master)**  
**(Modbus TCP Slave)**  
**(PROFIBUS Master)**  
**(PROFIBUS Slave)**  
**(BACnet Slave)**  
**(CANopen)**  
**(DeviceNet Slave)**  
**(EtherNet/IP)**  
**(Modbus TCP Slave)**  
**(PROFIBUS Slave)**  
**(PROFINET Slave)**  
**(PROFINET)**  
**(BACnet Slave)**  
**(BACnet Master)**  
**(IEC 61850 Server)**  
**(KNX)**  
**(DALI)**  
**(MQTT)**  
**(IO-Link Slave)**

Do you have an your customer protocol?

[www.adfweb.com?Product=HD67003](http://www.adfweb.com?Product=HD67003)

Do you need to choose a device? do you want help?

[www.adfweb.com?Cmd=helpme](http://www.adfweb.com?Cmd=helpme)

**INDEX:**

	Page
INDEX	2
UPDATED DOCUMENTATION	2
REVISION LIST	2
WARNING	2
TRADEMARKS	2
SECURITY ALERT	3
EXAMPLE OF CONNECTION	4
CONNECTION SCHEME	5
CHARACTERISTICS	7
CONFIGURATION	7
POWER SUPPLY	8
FUNCTION MODES	9
LEDS	10
SNMP	11
CAN	12
USE OF COMPOSITOR SW67171	13
NEW PROJECT / OPEN PROJECT	14
SOFTWARE OPTIONS	15
SET COMMUNICATION	17
SET SNMP ACCESS	19
RECEIVE FRAMES	20
SEND FRAMES	22
UPDATE DEVICE	24
MECHANICAL DIMENSIONS	26
ORDERING INFORMATIONS	28
ACCESSORIES	28
DISCLAIMER	29
OTHER REGULATIONS AND STANDARDS	29
WARRANTIES AND TECHNICAL SUPPORT	30
RETURN POLICY	30

**UPDATED DOCUMENTATION:**

Dear customer, we thank you for your attention and we remind you that you need to check that the following document is:

- ✚ Updated
- ✚ Related to the product you own

To obtain the most recently updated document, note the “document code” that appears at the top right-hand corner of each page of this document.

With this “Document Code” go to web page [www.adfweb.com/download/](http://www.adfweb.com/download/) and search for the corresponding code on the page. Click on the proper “Document Code” and download the updates.

**REVISION LIST:**

Revision	Date	Author	Chapter	Description
1.000	07/01/2020	Ff	All	First Release

**WARNING:**

ADFweb.com reserves the right to change information in this manual about our product without warning. ADFweb.com is not responsible for any error this manual may contain.

**TRADEMARKS:**

All trademarks mentioned in this document belong to their respective owners.

**SECURITY ALERT:****GENERAL INFORMATION**

To ensure safe operation, the device must be operated according to the instructions in the manual. When using the device, legal and safety regulation are required for each individual application. The same applies also when using accessories.

**INTENDED USE**

Machines and systems must be designed so the faulty conditions do not lead to a dangerous situation for the operator (i.e. independent limit switches, mechanical interlocks, etc.).

**QUALIFIED PERSONNEL**

The device can be used only by qualified personnel, strictly in accordance with the specifications. Qualified personnel are persons who are familiar with the installation, assembly, commissioning and operation of this equipment and who have appropriate qualifications for their job.

**RESIDUAL RISKS**

The device is state-of-the-art and is safe. The instruments can represent a potential hazard if they are inappropriately installed and operated by untrained personnel. These instructions refer to residual risks with the following symbol:



This symbol indicates that non-observance of the safety instructions is a danger for people that could lead to serious injury or death and / or the possibility of damage.

**CE CONFORMITY**

The declaration is made by our company. You can send an email to [support@adfweb.com](mailto:support@adfweb.com) or give us a call if you need it.

**EXAMPLE OF CONNECTION:**

**CAN / SNMP - Converter**  
HD67171-A1

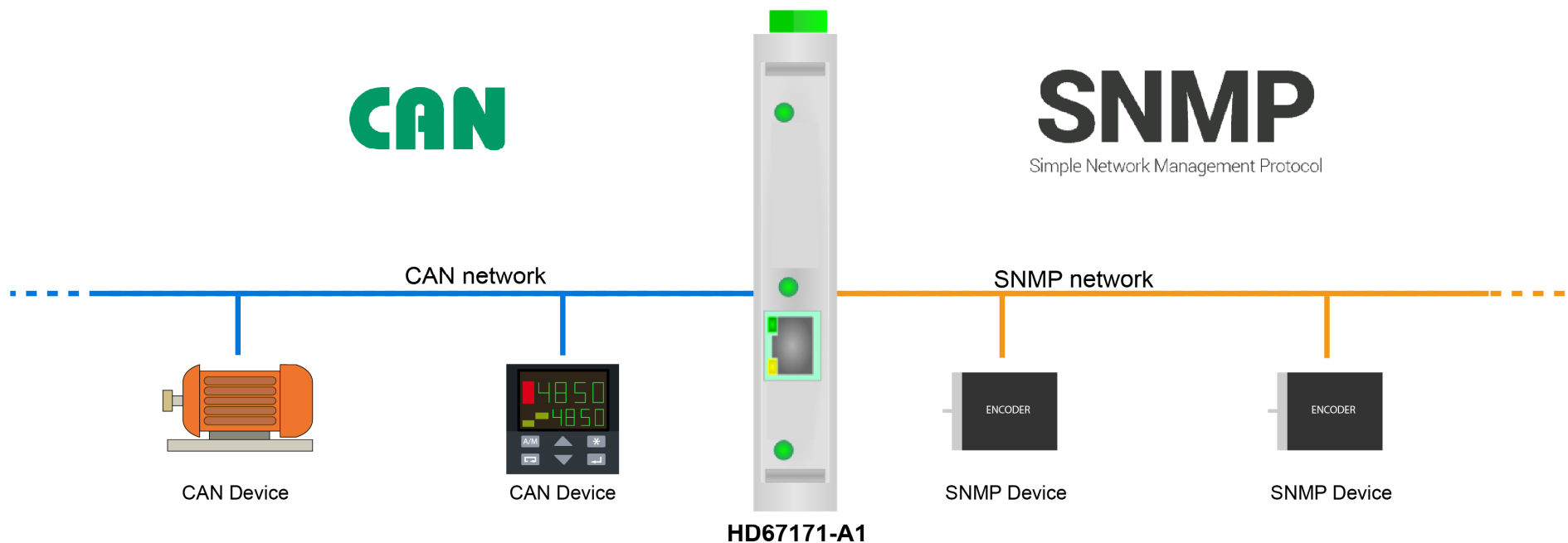

**ADFweb.com**



**+39 0438 309 131**



**+39 349 440 9592**



**support@adfweb.com**

**CONNECTION SCHEME:**

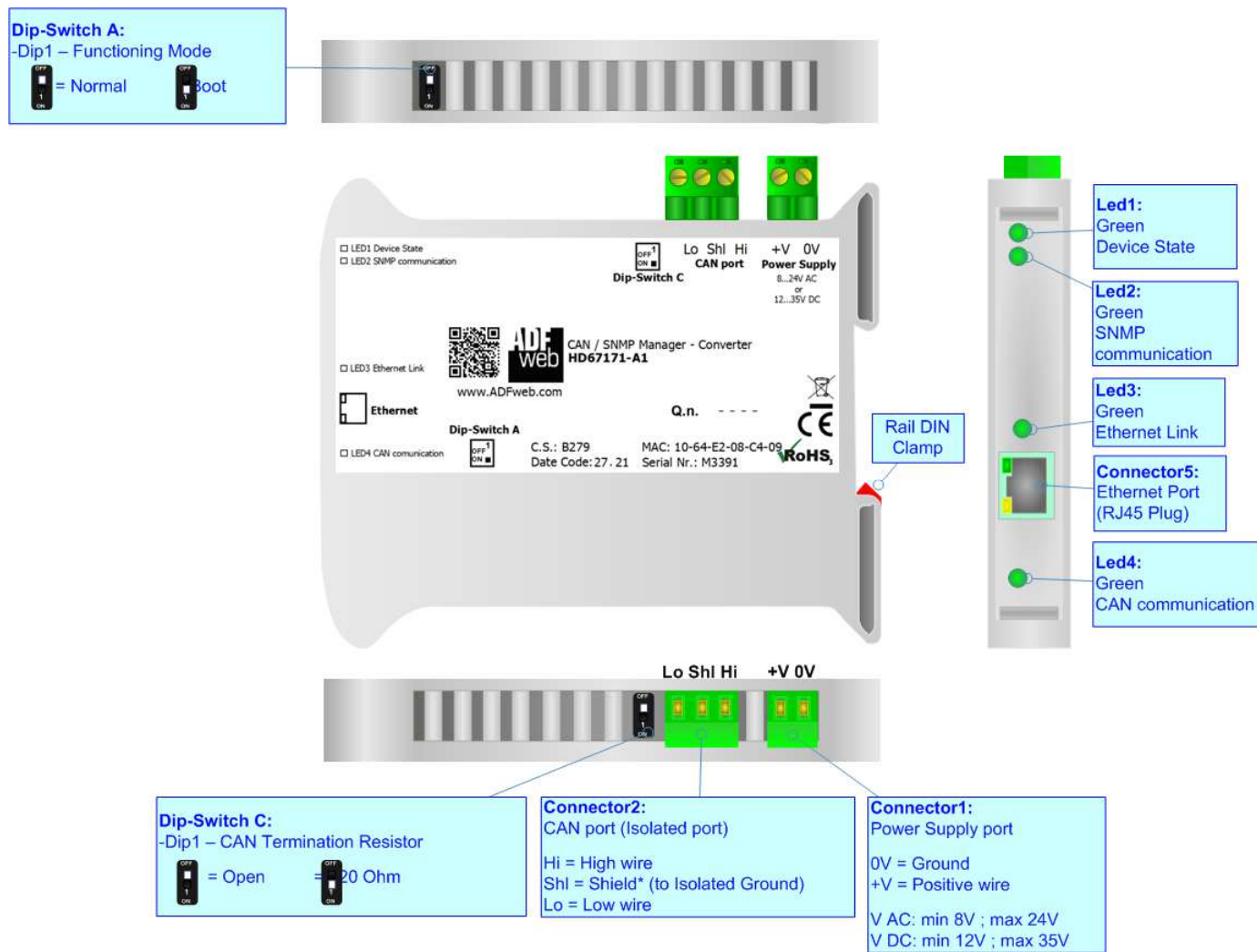

Figure 1a: Connection scheme for HD67171-A1

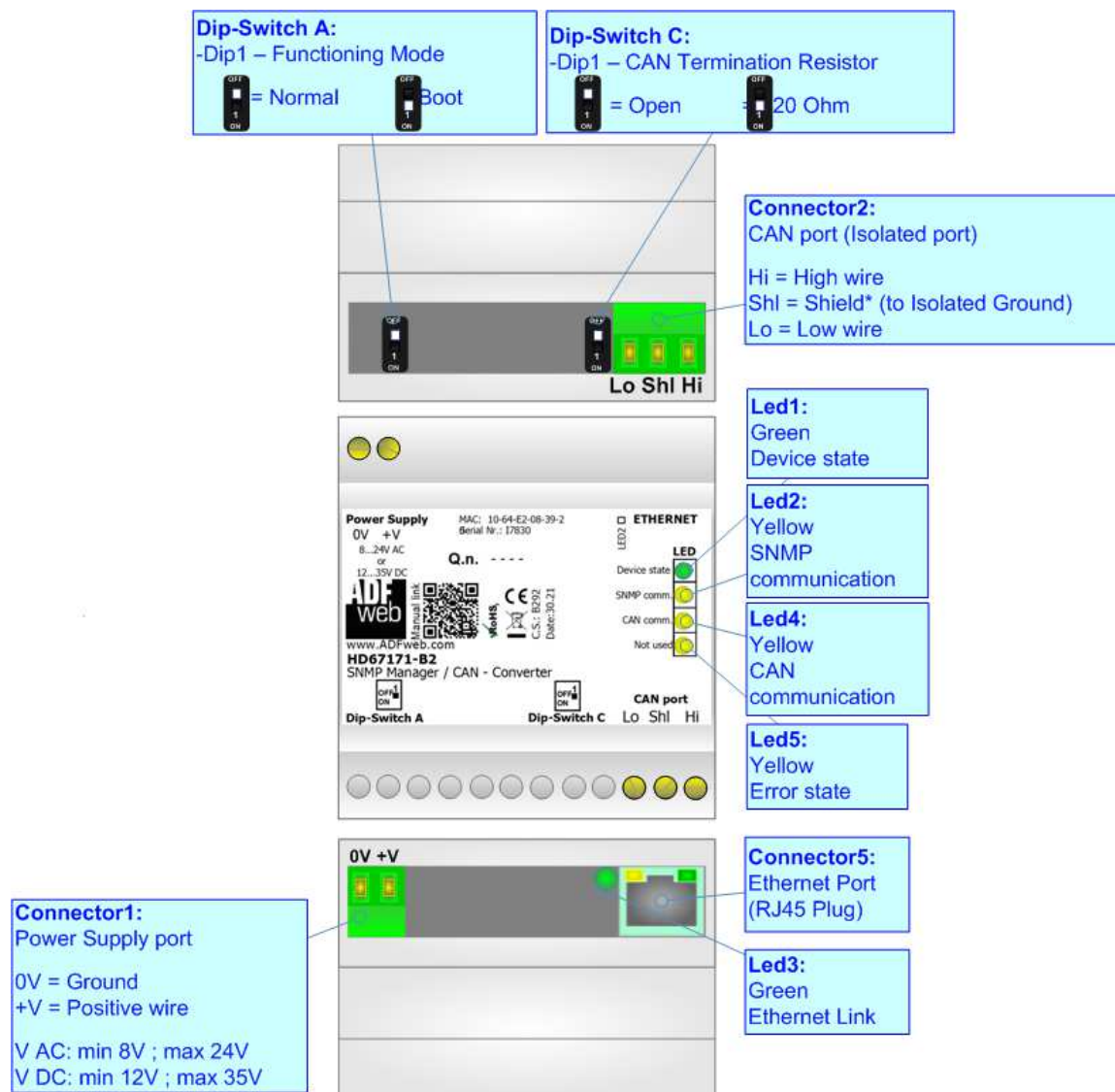

Figure 1b: Connection scheme for HD67171-B2

**CHARACTERISTICS:**

The HD67171-A1 and HD67171-B2 is a CAN / SNMP Manager - Converter.

It has the following characteristics:

- Up to 1024 bytes in reading and 1024 bytes in writing;
- Triple isolation between CAN - Power Supply, CAN - Ethernet, Power Supply - Ethernet.
- Two-directional information between CAN bus and SNMP bus;
- Mountable on 35mm Rail DIN;
- Wide power supply input range: 8...24V AC or 12...35V DC;
- Wide temperature range: -40°C / 85°C [-40°F / +185°F].

**CONFIGURATION:**

You need Compositor SW67171 software on your PC in order to perform the following:

- Define the parameter of SNMP line;
- Define the parameter of CAN line;
- Define the CAN frames that the converter can accept;
- Define the CAN frames that the converter sends through the CAN line;
- Define the map of CAN byte that must be written in the SNMP array;
- Define the map of which SNMP bytes must be written in CAN frames;
- Update the device.

**POWER SUPPLY:**

The devices can be powered at 8...24V AC and 12...35V DC. For more details see the two tables below.

VAC		VDC	
Vmin	Vmax	Vmin	Vmax
8V	24V	12V	35V

Consumption at 24V DC:

Device	Consumption [W/VA]
HD67171-A1	3.5
HD67171-B2	3.5

**Connector1:**  
Power Supply port  
0V = Ground  
+V = Positive wire  
V AC: min 8V ; max 24V  
V DC: min 12V ; max 35V

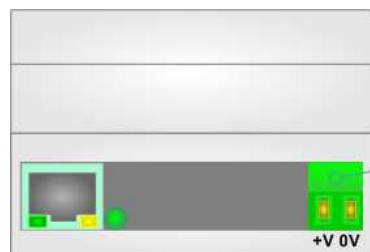

**Connector1:**  
Power Supply port  
0V = Ground  
+V = Positive wire  
V AC: min 8V ; max 24V  
V DC: min 12V ; max 35V

**Caution: Not reverse the polarity power**

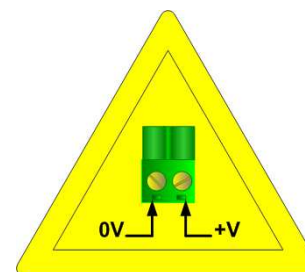

HD67171-A1

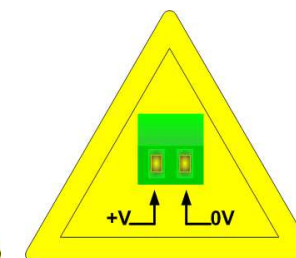

HD67171-B2



**FUNCTION MODES:**

The device has got two functions mode depending of the position of the 'Dip1 of Dip-Switch A':

- The first, with 'Dip1 of Dip-Switch A' at "OFF" position, is used for the normal working of the device.
- The second, with 'Dip1 of Dip-Switch A' at "ON" position, is used for upload the Project and/or Firmware.

For the operations to follow for the updating, see 'UPDATE DEVICE' section.

According to the functioning mode, the LEDs will have specifics functions, see 'LEDS' section.

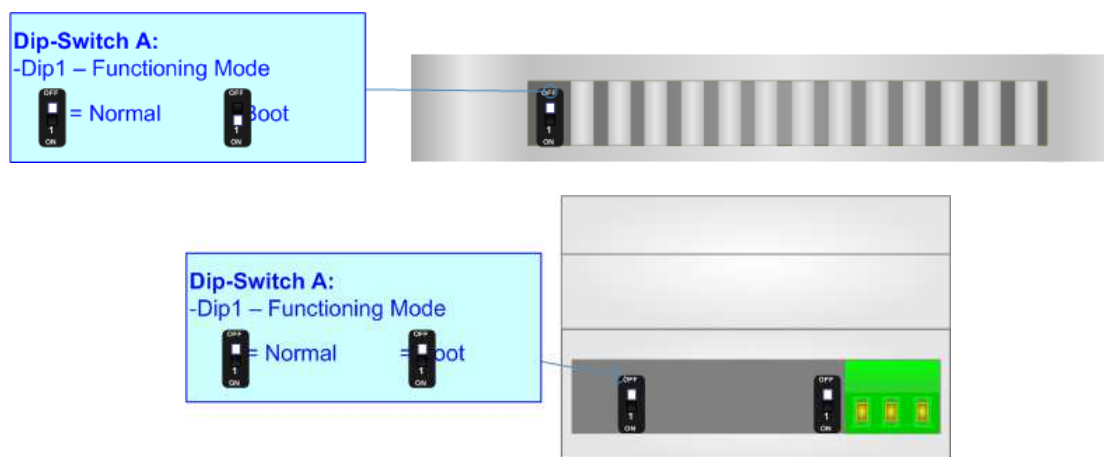

**LEDS:**

The devices has got four (five for HD67515-B2) LEDs that are used to give information of the functioning status. The various meanings of the LEDs are described in the table below.

LED	Normal Mode	Boot Mode
1: Device State	Blinks slowly (~1Hz)	<b>Blinks quickly:</b> Boot state <b>Blinks very slowly (~0.5Hz):</b> update in progress
2: SNMP Communication	Blinks when SNMP responses are received	<b>Blinks quickly:</b> Boot state <b>Blinks very slowly (~0.5Hz):</b> update in progress
3: Ethernet Link	<b>ON:</b> Ethernet cable connected <b>OFF:</b> Ethernet cable disconnected	<b>ON:</b> Ethernet cable connected <b>OFF:</b> Ethernet cable disconnected
4: CAN Communication	Blinks when CAN frames are received	<b>Blinks quickly:</b> Boot state <b>Blinks very slowly (~0.5Hz):</b> update in progress
5: Not used (Present only on HD67171-B2)	OFF	<b>Blinks quickly:</b> Boot state <b>Blinks very slowly (~0.5Hz):</b> update in progress

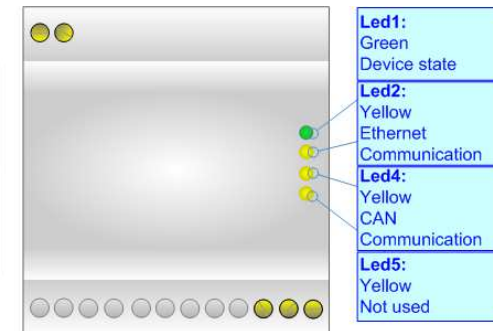
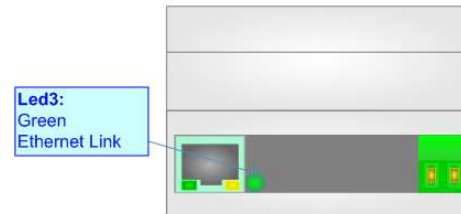
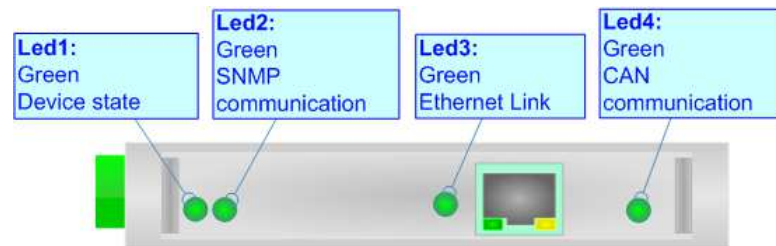

**SNMP:**

The SNMP connection must be made using Connector5 of HD67171-A1/B2 with at least a Category 5E cable. The maximum length of the cable should not exceed 100m. The cable has to conform to the T568 norms relative to connections in cat.5 up to 100 Mbps. To connect the device to an Hub/Switch is recommended the use of a straight cable, to connect the device to a PC/other is recommended the use of a cross cable.

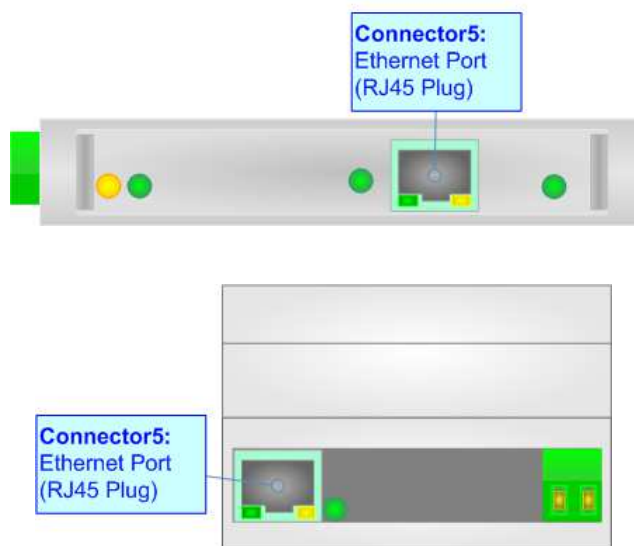

**CAN:**

For terminate the CAN line with a 120Ω resistor it is necessary that the Dip1 of 'Dip-Switch C' is at ON position.

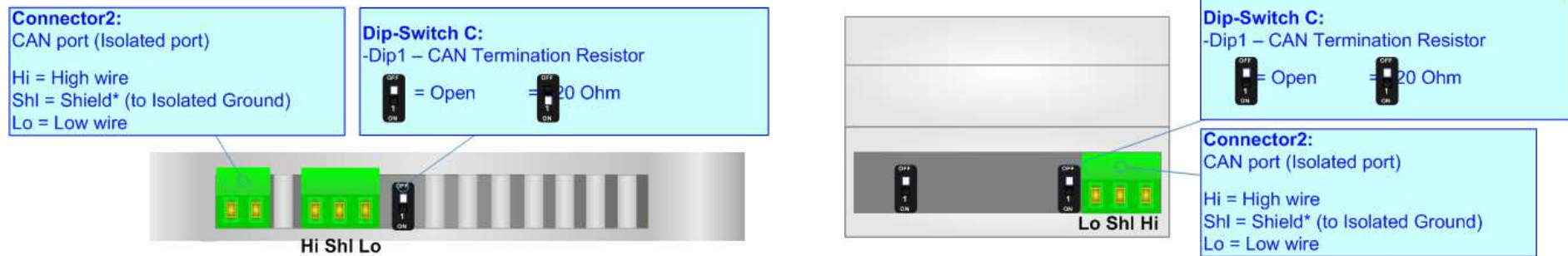

Cable characteristics:

<b>DC parameter:</b>	Impedance	70 Ohm/m
<b>AC parameters:</b>	Impedance	120 Ohm/m
	Delay	5 ns/m
<b>Length</b>	<b>Baud Rate [bps]</b>	<b>Length MAX [m]</b>
	10 K	5000
	20 K	2500
	50 K	1000
	100 K	650
	125 K	500
	250 K	250
	500 K	100
	800 K	50
	1000 K	25

## USE OF COMPOSITOR SW67171:

To configure the Converter, use the available software that runs with Windows called SW67171. It is downloadable on the site [www.adfweb.com](http://www.adfweb.com) and its operation is described in this document. (*This manual is referenced to the last version of the software present on our web site*). The software works with MSWindows (XP, Vista, Seven, 8, 10; 32/64bit).

When launching the SW67171, the window below appears (Fig. 2).



### Note:

It is necessary to have installed .Net Framework 4.

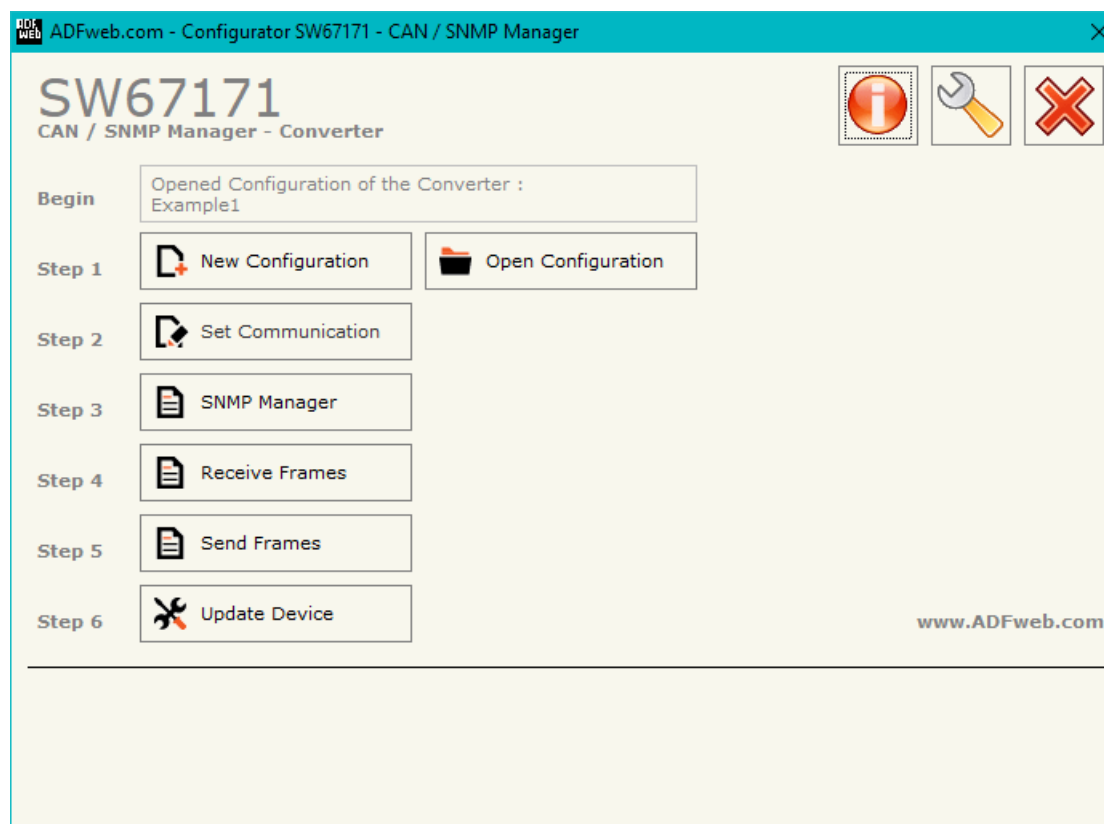
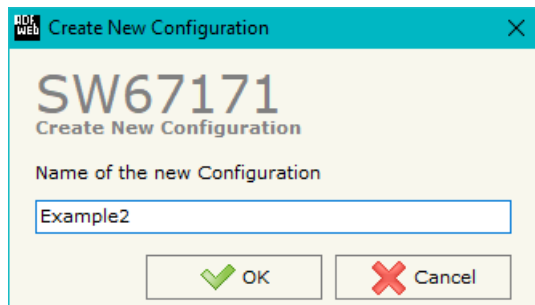

Figure 2: Main window for SW67171

**NEW CONFIGURATION / OPEN CONFIGURATION:**

The “**New Configuration**” button creates the folder which contains the entire device’s configuration.



A device’s configuration can also be imported or exported:

- To clone the configurations of a Programmable “CAN / SNMP Manager - Converter” in order to configure another device in the same manner, it is necessary to maintain the folder and all its contents;
- To clone a project in order to obtain a different version of the project, it is sufficient to duplicate the project folder with another name and open the new folder with the button “**Open Configuration**”.

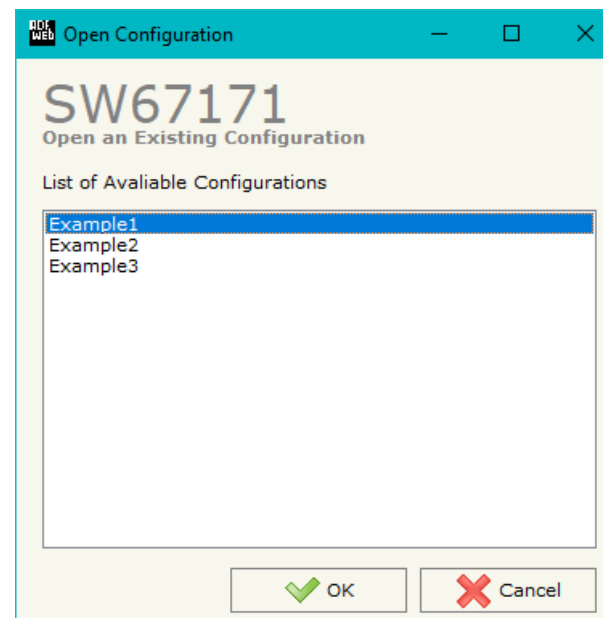

**SOFTWARE OPTIONS:**

By pressing the “**Settings**” () button there is the possibility to change the language of the software and check the updatings for the compositor.

In the section “Language” it is possible to change the language of the software.

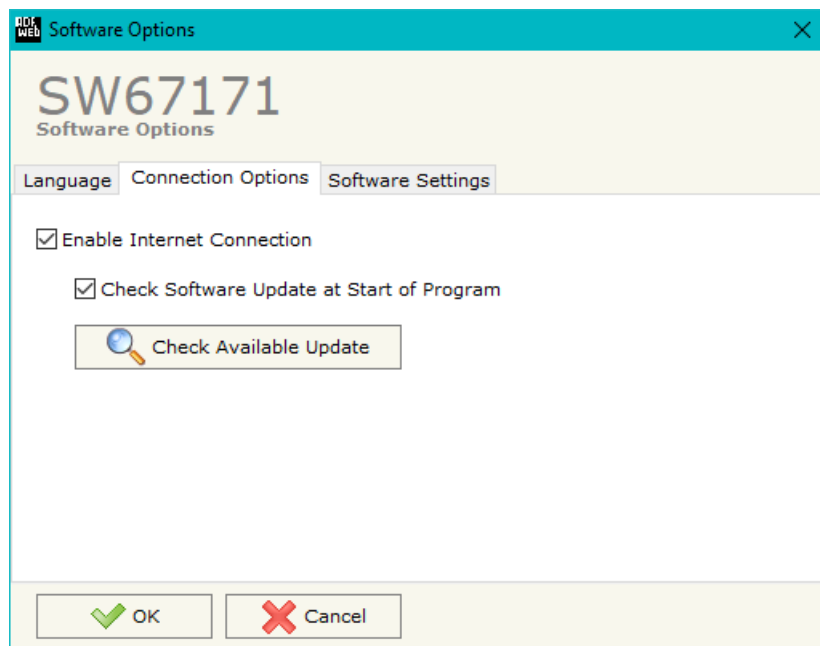

In the section “Connection Options”, it is possible to check if there are some updatings of the software compositor in ADFweb.com website. Checking the option “**Check Software Update at Start of Program**”, the SW67171 check automatically if there are updatings when it is launched.

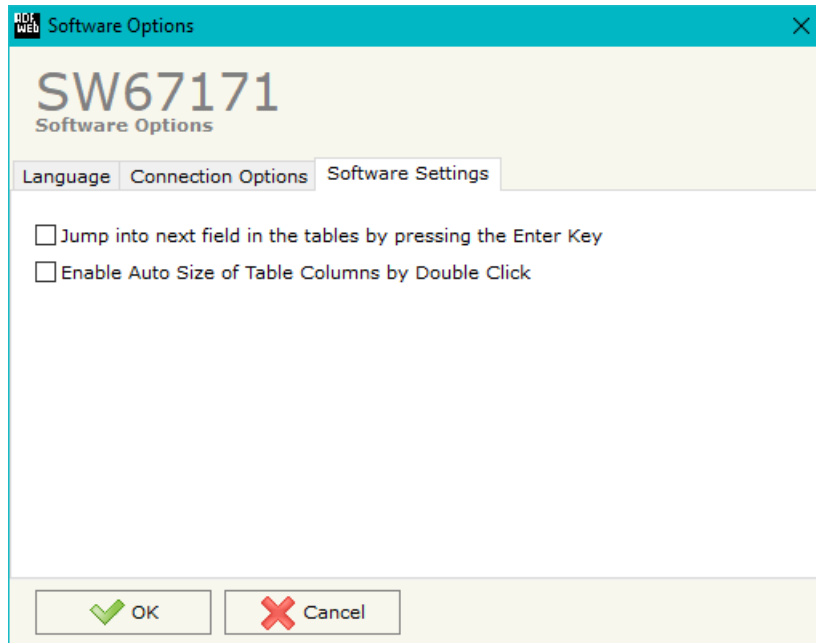

In the section "Software Settings", it is possible to enable/disable some keyboard's commands for an easier navigation inside the tables contained in the different sections of the software.



**SET COMMUNICATION:**

This section define the fundamental communication parameters of two buses, SNMP and CAN.

By Pressing the **"Set Communication"** button from the main window for SW67171 (Fig. 2) the window "Set Communication" appears (Fig. 3).

The window is divided in two sections, one for the SNMP and the other for the CAN.

The means of the fields for "SNMP Manager" are:

- In the fields **"IP ADDRESS"** the IP address of the converter is defined;
- In the fields **"SUBNET Mask"** the SubNet Mask of the converter is defined;
- In the fields **"GATEWAY"** the default gateway of the network is defined. This feature can be enabled or disabled pressing the Check Box field. This feature is used for going out of the net;
- In the field **"SNMP Name of Station"** the name for SNMP Manager station is defined;

The means of the fields for the "CAN" section are:

- In the field **"Baudrate"** the CAN baudrate is defined.

The screenshot shows a web-based configuration window titled "Set Communication" for device "SW67171". The window is divided into two main sections: "SNMP Manager" and "CAN".

**SNMP Manager Section:**

- IP ADDRESS:** 192 . 168 . 0 . 10
- SUBNET Mask:** 255 . 255 . 255 . 0
- GATEWAY:**  (unchecked) 192 . 168 . 0 . 1
- SNMP Name of Station:** devicename1

**CAN Section:**

- Baudrate:** 50K

At the bottom of the window, there are two buttons: "OK" (with a green checkmark) and "Cancel" (with a red X).

Figure 3: "Set Communication" window

**SET SNMP ACCESS:**

N	Enable	IP Address	Version	Community Name	OID	Type	Mode	OnChange	OnCMD	OnTimer	Time	Position	Num Bytes	Conversion	Cancel	User	Auth Pass	Priv Pass	Security Level	Auth Mode	Priv Mode	Mnemonic	
1	<input checked="" type="checkbox"/>	192.168.0.150	1	Public	1.3.6.1.4.1.33118.	Int	Get	<input checked="" type="checkbox"/>	<input checked="" type="checkbox"/>	<input checked="" type="checkbox"/>	1000	0	2	None	<input type="checkbox"/>								
2	<input checked="" type="checkbox"/>	192.168.0.151	1	Private	1.3.6.1.4.1.33118.	String	Trap	<input type="checkbox"/>	<input type="checkbox"/>	<input type="checkbox"/>		2	10	None	<input type="checkbox"/>								
3	<input checked="" type="checkbox"/>							<input type="checkbox"/>	<input type="checkbox"/>	<input type="checkbox"/>					<input type="checkbox"/>								
4	<input checked="" type="checkbox"/>							<input type="checkbox"/>	<input type="checkbox"/>	<input type="checkbox"/>					<input type="checkbox"/>								
5	<input checked="" type="checkbox"/>							<input type="checkbox"/>	<input type="checkbox"/>	<input type="checkbox"/>					<input type="checkbox"/>								
6	<input checked="" type="checkbox"/>							<input type="checkbox"/>	<input type="checkbox"/>	<input type="checkbox"/>					<input type="checkbox"/>								
7	<input checked="" type="checkbox"/>							<input type="checkbox"/>	<input type="checkbox"/>	<input type="checkbox"/>					<input type="checkbox"/>								
8	<input checked="" type="checkbox"/>							<input type="checkbox"/>	<input type="checkbox"/>	<input type="checkbox"/>					<input type="checkbox"/>								
9	<input checked="" type="checkbox"/>							<input type="checkbox"/>	<input type="checkbox"/>	<input type="checkbox"/>					<input type="checkbox"/>								

Figure 4: "Set SNMP Manager Access" window

By Pressing the "SNMP Manager" button from the main window for SW67171 (Fig. 2) the window "Set SNMP Manager Access" appears (Fig. 4).

The meaning of the fields in the window are the follows:

- If the field "Enable" is checked, the SNMP request is enabled;
- In the field "IP Address" the address of the SNMP Manager device to read/write is defined;
- In the field "Version" the SNMP version used to send the SNMP request (1 or 2 is allowed) is defined;
- In the field "Community Name" the Community Name used for the SNMP request is defined (selectable or editable manually);
- In the field "OID" the OID to read/write from/to the SNMP Manager device is defined;
- In the field "Type" the type of data to read/write ('String' or 'Int') is defined;
- In the field "Mode" the type of SNMP request used ('Get', 'Set' or 'Trap') is defined;
- By checking the field "On Change" the SNMP request (only for 'Set' Mode) is made only if SNMP data written by CAN side are changed;
- By checking the field "OnCMD" the SNMP request is sent only when a CAN message for the associated variable is received;
- If the field "On Timer" is checked, the SNMP request is sent cyclically;
- In the field "Time" the delay in ms between two SNMP requests is defined (if "On Timer" is checked);
- In the field "Position" it is possible to select the position where take/save the data from/to the internal memory array;

- In the field "**Num Bytes**" it is possible to select define the dimension of the SNMP data;
- In the field "**Conversion**" it is possible to select the conversion to apply to the data read/written from/to the SNMP Manager;
- If the field "**Cancel**" is checked, if the answer to the SNMP request is missing, the data on SNMP side are set to '0';
- If SNMP version is set to '3', the following fields must be set:
  - In the field "**User**" the user for the SNMP authentication is defined;
  - In the field "**Auth Pass**" the password for the SNMP authentication is defined;
  - In the field "**Priv Pass**" the password for Privacy authentication is defined;
  - In the field "**Security Level**" the type of security used is defined;
  - In the field "**Auth Mode**" the mode used for the authentication is defined;
  - In the field "**Priv Mode**" the mode used for Privacy is defined;
- In the field "**Mnemonic**" a description of the data inserted in the row is defined.

**Note:**

If the field "On change" and "On Timer" is checked and the "Poll Time" is different from 0, the converter sends the SNMP writing request cyclically and also when the data is changed.

**Note:**

If the "Trap" mode is used, the fields "On Change" and "On Timer" must be disabled.

**RECEIVE FRAMES:**

By pressing the **Receive Frames** button from the main window for SW67171 (Fig. 2) the "Receive CAN Frames" window appears (Fig. 5). The COB inserted in this table contains the Output data of SNMP. These frames are accepted by the Converter.

N	Enable	CobID	Type	Dimension	TimeOut	Byte1	Byte2	Byte3	Byte4	Byte5	Byte6	Byte7	Byte8	Mnemonic
1	<input checked="" type="checkbox"/>	0x181	2.0A (11 bits)	8	10000	0	1	2	3	4	5	6	7	
2	<input checked="" type="checkbox"/>	0x182	2.0A (11 bits)	8	0	8	9	10	11	12	13	14	15	
3	<input checked="" type="checkbox"/>													
4	<input checked="" type="checkbox"/>													
5	<input checked="" type="checkbox"/>													

Figure 5: "Receive CAN Frames" window

The data of the columns have the following meanings:

- If the field **Enable** is checked, the CAN frame is enabled;
- In the field **Cob-ID** the COB of the CAN frame is defined;
- In the field **Type** the type of CAN packet use for the Cob-ID is defined (2.0A (11 bits) or 2.0B (29 bits));
- In the field **Dimension** the number of byte of the COB (from 1 to 8) is defined;
- The field **TimeOut** is used for put at zero the data into SNMP array if the CAN frame arrives with a frequency less than the time expressed in the field. If the value in the field is '0', it means that you don't want to use this feature;
- In the field **Byte1** insert the byte of the SNMP array where saving 1st byte of the CAN message;
- In the field **Byte2** insert the byte of the SNMP array where saving 2nd byte of the CAN message;
- In the field **Byte3** insert the byte of the SNMP array where saving 3rd byte of the CAN message;
- In the field **Byte4** insert the byte of the SNMP array where saving 4th byte of the CAN message;
- In the field **Byte5** insert the byte of the SNMP array where saving 5th byte of the CAN message;
- In the field **Byte6** insert the byte of the SNMP array where saving 6th byte of the CAN message;

- In the field "**Byte7**" insert the byte of the SNMP array where saving 7th byte of the CAN message;
- In the field "**Byte8**" insert the byte of the SNMP array where saving 8th byte of the CAN message;
- In the field "**Mnemonic**" a brief description is defined.

**SEND FRAMES:**

By pressing the "Send Frames" button from the main window for SW67171 (Fig. 2) the "Send CAN frames" window appears (Fig. 6). The COB inserted in this table contains the data received from SNMP side. These frames are sent by the converter.

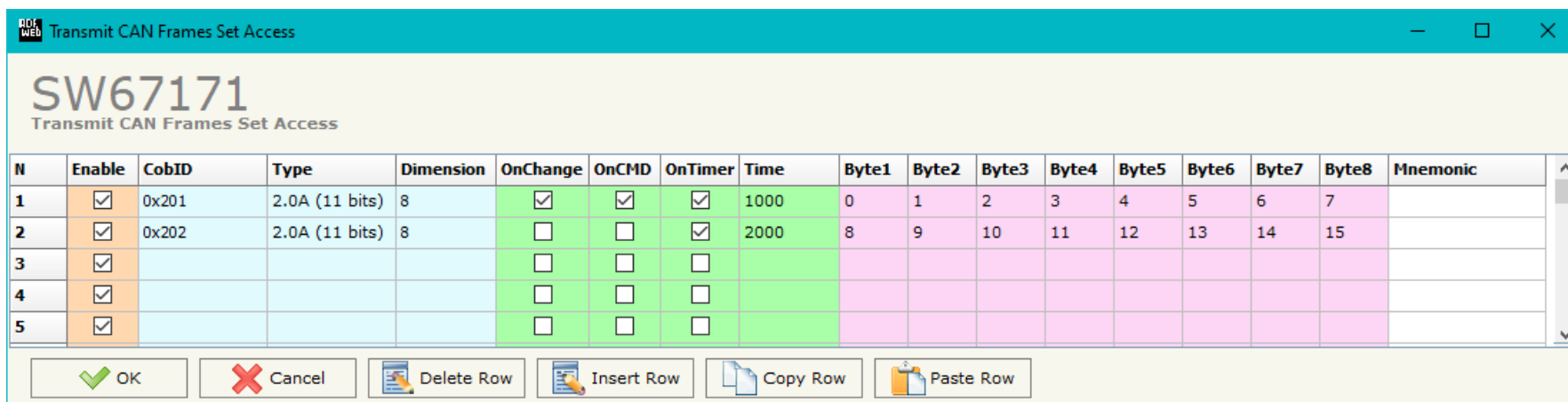

Figure 6: "Transmit CAN Frames Set Access" window

The data of the columns have the following meanings:

- If the field "Enable" is checked, the CAN frame is enabled;
- In the field "Cob-ID" the COB of the CAN frame is defined;
- In the field "Type" the type of CAN packet use for this Cob-ID is defined (2.0A (11 bits) or 2.0B (29 bits));
- In the field "Dimension" the number of byte of the COB (from 1 to 8) is defined;
- If the field "OnChange" is checked, the frame is sent when the data from SNMP change;
- If the field "OnCMD" is checked, the frame is sent when a SNMP message is received;
- If the field "OnTimer" is checked, the frame is sent cyclically with the delay defined in the field "Time" (expressed in ms);
- In the field "Byte1" insert the byte of the SNMP array where taking 1st byte of the CAN message;
- In the field "Byte2" insert the byte of the SNMP array where taking 2nd byte of the CAN message;
- In the field "Byte3" insert the byte of the SNMP array where taking 3rd byte of the CAN message;

- In the field "**Byte4**" insert the byte of the SNMP array where taking 4th byte of the CAN message;
- In the field "**Byte5**" insert the byte of the SNMP array where taking 5th byte of the CAN message;
- In the field "**Byte6**" insert the byte of the SNMP array where taking 6th byte of the CAN message;
- In the field "**Byte7**" insert the byte of the SNMP array where taking 7th byte of the CAN message;
- In the field "**Byte8**" insert the byte of the SNMP array where taking 8th byte of the CAN message;
- In the field "**Mnemonic**" it is possible to insert a brief description.

**UPDATE DEVICE:**

By pressing the **"Update Device"** button, it is possible to load the created Configuration into the device; and also the Firmware, if necessary.

If you don't know the actual IP address of the device you have to use this procedure:

- Turn OFF the Device;
- Put Dip1 of 'Dip-Switch A' in ON position;
- Turn on the device
- Connect the Ethernet cable;
- Insert the IP **"192.168.2.205"**;
- Press the **"Ping"** button, "Device Found!" must appear;
- Press the **"Next"** button;
- Select which operations you want to do;
- Press the **"Execute update firmware"** button to start the upload;
- When all the operations are "OK" turn off the Device;
- Put Dip1 of 'Dip-Switch A' at OFF position;
- Turn ON the device.

If you know the actual IP address of the device, you have to use this procedure:

- Turn on the Device with the Ethernet cable inserted;
- Insert the actual IP of the Converter;
- Press the **"Ping"** button, must appear "Device Found!";
- Press the **"Next"** button;
- Select which operations you want to do;
- Press the **"Execute update firmware"** button to start the upload;
- When all the operations are "OK" the device automatically goes at Normal Mode.

At this point the configuration/firmware on the device is correctly update.

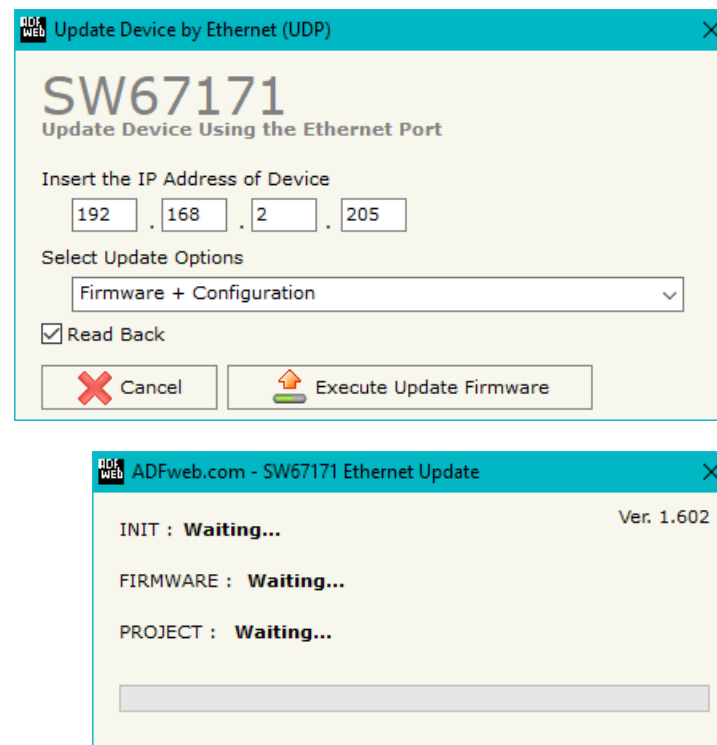





Figure 7: "Update device" windows



 **Note:**  
When you install a new version of the software, if it is the first time it is better you do the update of the Firmware in the HD67171-A1/B2 device.

 **Note:**  
When you receive the device, for the first time, you also have to update the Firmware in the HD67171-A1/B2 device.

 **Warning:**  
If Fig. 8 appears when you try to do the Update try these points before seeking assistance:

- Try to repeat the operations for the updating;
- Try with another PC;
- Try to restart the PC;
- Check the LAN settings;
- If you are using the program inside a Virtual Machine, try to use in the main Operating System;
- If you are using Windows Seven, Vista, 8 or 10 make sure that you have the administrator privileges;
- In case you have to program more than one device, using the "UDP Update", you have to cancel the ARP table every time you connect a new device on Ethernet. For do this you have to launch the "Command Prompt" and write the command "arp -d". Pay attention that with Windows Vista, Seven, 8 or 10 you have to launch the "Command Prompt" with Administrator Rights;
- Pay attention at Firewall lock.

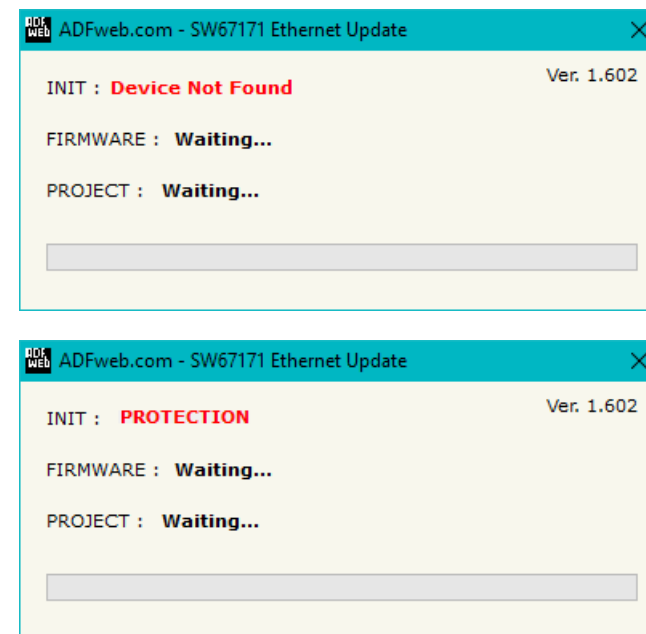

Figure 8: "Protection" window

 In the case of HD67171-A1/B2 you have to use the software "SW67171": [www.adfweb.com/download/filefold/SW67171.zip](http://www.adfweb.com/download/filefold/SW67171.zip).

**MECHANICAL DIMENSIONS:**

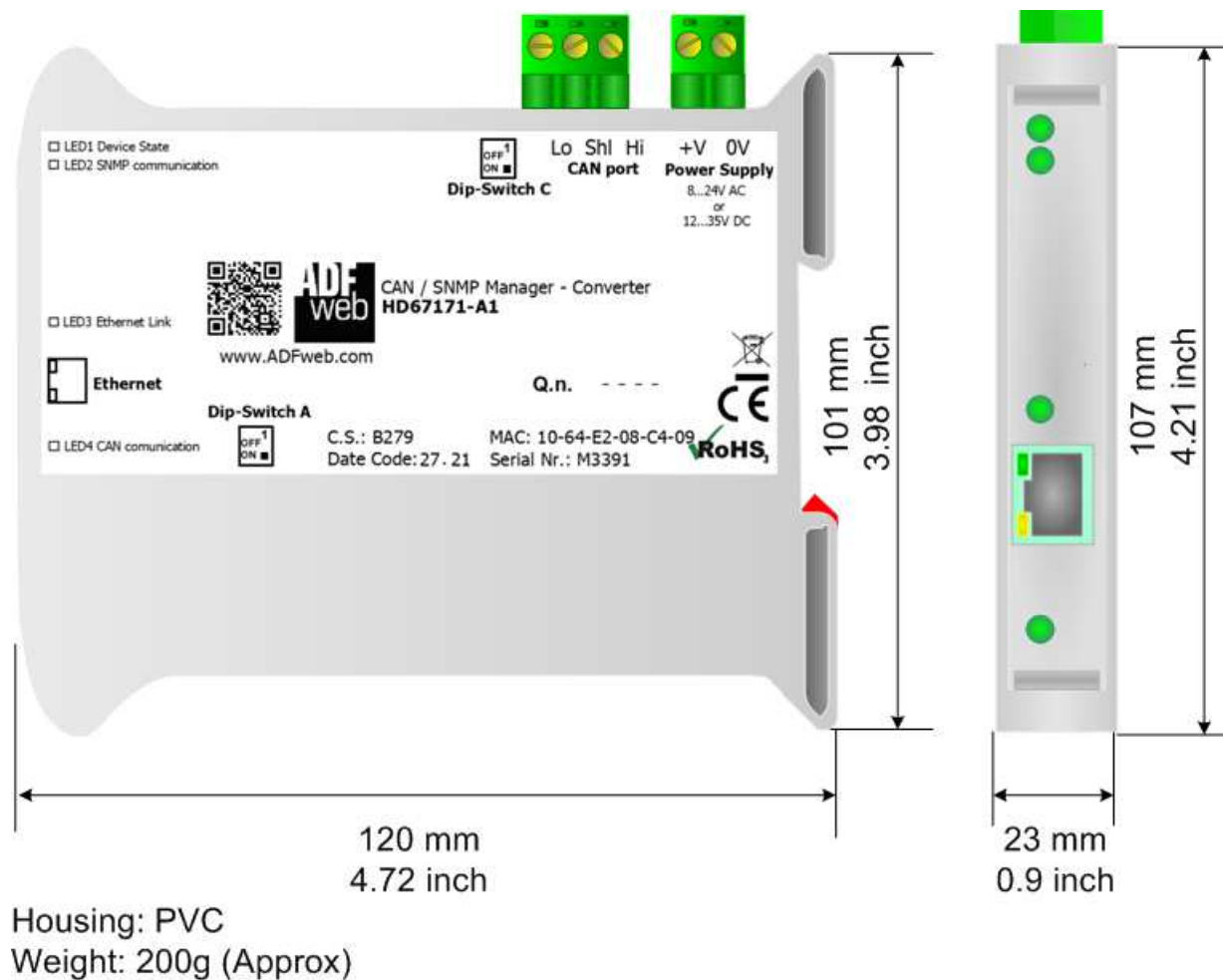
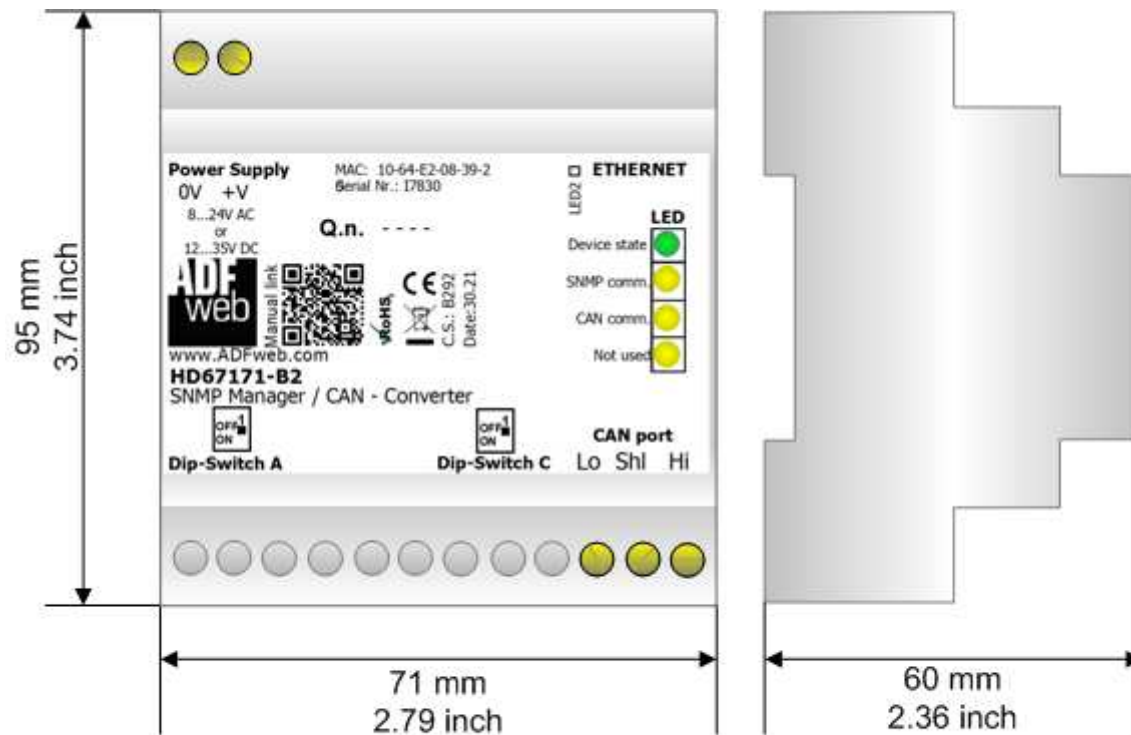

Figure 9a: Mechanical dimensions scheme for HD67171-A1



Housing: PVC  
 Weight: 200g (Approx)

Figure 9b: Mechanical dimensions scheme for HD67171-B2

**ORDERING INFORMATIONS:**

The ordering part number is formed by a valid combination of the following:

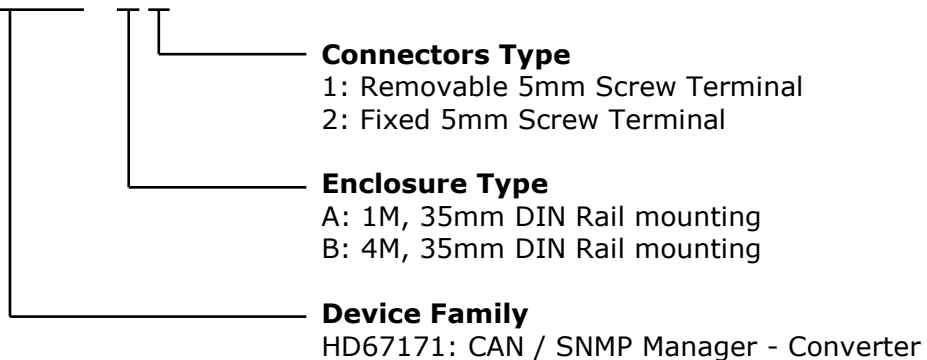
**HD67171 - x x**

Order Code: **HD67171-A1** - CAN / SNMP Manager – Converter ( Housing type: A, Terminal Blocks Connectors )

Order Code: **HD67171-B2** - CAN / SNMP Manager – Converter ( Housing type: B, Terminal Blocks Connectors )

**ACCESSORIES:**

Order Code: **AC34001** - 35mm Rail DIN - Power Supply 220/240V AC 50/60Hz – 12 V AC

Order Code: **AC34002** - 35mm Rail DIN - Power Supply 110V AC 50/60Hz – 12 V AC

**DISCLAIMER:**

All technical content within this document can be modified without notice. The content of the document is a under continual renewal. For losses due to fire, earthquake, third party access or other accidents, or intentional or accidental abuse, misuse, or use under abnormal conditions repairs are charged to the user. ADFweb.com S.r.l. will not be liable for accidental loss of use or inability to use this product, such as loss of business income. ADFweb.com S.r.l. shall not be liable for consequences of improper use.

**OTHER REGULATIONS AND STANDARDS:****WEEE INFORMATION**

Disposal of old electrical and electronic equipment (as in the European Union and other European countries with separate collection systems).

— This symbol on the product or on its packaging indicates that this product may not be treated as household rubbish. Instead, it should be taken to an applicable collection point for the recycling of electrical and electronic equipment. If the product is disposed correctly, you will help prevent potential negative environmental factors and impact of human health, which could otherwise be caused by inappropriate disposal. The recycling of materials will help to conserve natural resources. For more information about recycling this product, please contact your local city office, your household waste disposal service or the shop where you purchased the product.

**RESTRICTION OF HAZARDOUS SUBSTANCES DIRECTIVE**

The device respects the 2002/95/EC Directive on the restriction of the use of certain hazardous substances in electrical and electronic equipment (commonly referred to as Restriction of Hazardous Substances Directive or RoHS).

**CE MARKING**

The product conforms with the essential requirements of the applicable EC directives.

**WARRANTIES AND TECHNICAL SUPPORT:**

For fast and easy technical support for your ADFweb.com SRL products, consult our internet support at [www.adfweb.com](http://www.adfweb.com).  
Otherwise contact us at the address [support@adfweb.com](mailto:support@adfweb.com)

**RETURN POLICY:**

If while using your product you have any problem and you wish to exchange or repair it, please do the following:

- Obtain a Product Return Number (PRN) from our internet support at [www.adfweb.com](http://www.adfweb.com). Together with the request, you need to provide detailed information about the problem.
- Send the product to the address provided with the PRN, having prepaid the shipping costs (shipment costs billed to us will not be accepted).

If the product is within the warranty of twelve months, it will be repaired or exchanged and returned within three weeks. If the product is no longer under warranty, you will receive a repair estimate.



**ADFweb.com S.r.l.**  
Via Strada Nuova, 17  
IT-31010 Marenò di Piave  
TREVISO (Italy)  
Phone +39.0438.30.91.31  
Fax +39.0438.49.20.99  
[www.adfweb.com](http://www.adfweb.com)

