

# User Manual

Revision 1.000  
English

## DALI / BACnet Master - Converter

(Order Code: HD67832-IP-B2, HD67832-MSTP-B2)

for Website information:

[www.adfweb.com?Product=HD67832](http://www.adfweb.com?Product=HD67832)

for Price information:

[www.adfweb.com?Price=HD67832-IP-B2](http://www.adfweb.com?Price=HD67832-IP-B2)

[www.adfweb.com?Price=HD67832-MSTP-B2](http://www.adfweb.com?Price=HD67832-MSTP-B2)

### Benefits and Main Features:

- ✦ Very easy to configure
- ✦ Electrical isolation
- ✦ Temperature range: -40°C/85°C (-40°F/185°F)



For others DALI products, see also the following links:

#### Converter DALI to

- [www.adfweb.com?Product=HD67822](http://www.adfweb.com?Product=HD67822)
- [www.adfweb.com?Product=HD67831](http://www.adfweb.com?Product=HD67831)
- [www.adfweb.com?Product=HD67833](http://www.adfweb.com?Product=HD67833)
- [www.adfweb.com?Product=HD67834](http://www.adfweb.com?Product=HD67834)
- [www.adfweb.com?Product=HD67835](http://www.adfweb.com?Product=HD67835)
- [www.adfweb.com?Product=HD67836](http://www.adfweb.com?Product=HD67836)
- [www.adfweb.com?Product=HD67837](http://www.adfweb.com?Product=HD67837)
- [www.adfweb.com?Product=HD67838](http://www.adfweb.com?Product=HD67838)
- [www.adfweb.com?Product=HD67839](http://www.adfweb.com?Product=HD67839)
- [www.adfweb.com?Product=HD67840](http://www.adfweb.com?Product=HD67840)
- [www.adfweb.com?Product=HD67842](http://www.adfweb.com?Product=HD67842)
- [www.adfweb.com?Product=HD67843](http://www.adfweb.com?Product=HD67843)
- [www.adfweb.com?Product=HD67844](http://www.adfweb.com?Product=HD67844)
- [www.adfweb.com?Product=HD67845](http://www.adfweb.com?Product=HD67845)
- [www.adfweb.com?Product=HD67848](http://www.adfweb.com?Product=HD67848)
- [www.adfweb.com?Product=HD67849](http://www.adfweb.com?Product=HD67849)
- [www.adfweb.com?Product=HD67850](http://www.adfweb.com?Product=HD67850)

- (KNX)**
- (RS485)**
- (BACnet/IP Slave)**
- (CAN)**
- (CANopen)**
- (DeviceNet Master)**
- (DeviceNet Slave)**
- (DMX)**
- (Ethernet)**
- (EtherNet/IP)**
- (Modbus Master)**
- (Modbus Slave)**
- (Modbus TCP Master)**
- (Modbus TCP Slave)**
- (PROFINET)**
- (SNMP Manager)**
- (SNMP Agent)**

Do you have an your customer protocol?

[www.adfweb.com?Product=HD67003](http://www.adfweb.com?Product=HD67003)

Do you need to choose a device? do you want help?

[www.adfweb.com?Cmd=helpme](http://www.adfweb.com?Cmd=helpme)



User Manual

**INDEX:**

	Page
INDEX	2
UPDATED DOCUMENTATION	2
REVISION LIST	2
WARNING	2
TRADEMARKS	2
SECURITY ALERT	3
EXAMPLE OF CONNECTION	4
CONNECTION SCHEME	5
CHARACTERISTICS	7
CONFIGURATION	7
POWER SUPPLY	8
FUNCTION MODES	9
LEDS	10
DALI	11
RS485 (FOR BACNET MS/TP)	12
ETHERNET	13
USE OF COMPOSITOR SW67832	14
NEW PROJECT / OPEN PROJECT	15
SOFTWARE OPTIONS	16
SET COMMUNICATION	18
DALI ACCESS	20
BACNET SET ACCESS	23
UPDATE DEVICE	27
USE OF DALI CONSOLE SOFTWARE	29
STRUCTURE OF THE SOFTWARE	30
SETUP	31
SEARCH	32
TEST DALI 2	32
NETWORK SETTING	33
MECHANICAL DIMENSIONS	39
ORDERING INFORMATIONS	40
ACCESSORIES	40
DISCLAIMER	41
OTHER REGULATIONS AND STANDARDS	41
WARRANTIES AND TECHNICAL SUPPORT	42
RETURN POLICY	42

**UPDATED DOCUMENTATION:**

Dear customer, we thank you for your attention and we remind you that you need to check that the following document is:

- ✚ Updated
- ✚ Related to the product you own

To obtain the most recently updated document, note the “document code” that appears at the top right-hand corner of each page of this document.

With this “Document Code” go to web page [www.adfweb.com/download/](http://www.adfweb.com/download/) and search for the corresponding code on the page. Click on the proper “Document Code” and download the updates.

**REVISION LIST:**

Revision	Date	Author	Chapter	Description
1.000	03/04/2020	VDB	All	First Release

**WARNING:**

ADFweb.com reserves the right to change information in this manual about our product without warning. ADFweb.com is not responsible for any error this manual may contain.

**TRADEMARKS:**

All trademarks mentioned in this document belong to their respective owners.

**SECURITY ALERT:****GENERAL INFORMATION**

To ensure safe operation, the device must be operated according to the instructions in the manual. When using the device, legal and safety regulation are required for each individual application. The same applies also when using accessories.

**INTENDED USE**

Machines and systems must be designed so the faulty conditions do not lead to a dangerous situation for the operator (i.e. independent limit switches, mechanical interlocks, etc.).

**QUALIFIED PERSONNEL**

The device can be used only by qualified personnel, strictly in accordance with the specifications. Qualified personnel are persons who are familiar with the installation, assembly, commissioning and operation of this equipment and who have appropriate qualifications for their job.

**RESIDUAL RISKS**

The device is state-of-the-art and is safe. The instruments can represent a potential hazard if they are inappropriately installed and operated by untrained personnel. These instructions refer to residual risks with the following symbol:



This symbol indicates that non-observance of the safety instructions is a danger for people that could lead to serious injury or death and / or the possibility of damage.

**CE CONFORMITY**

The declaration is made by our company. You can send an email to [support@adfweb.com](mailto:support@adfweb.com) or give us a call if you need it.

**EXAMPLE OF CONNECTION:**

**DALI / BACnet - Converter**  
 HD67832-IP-B2

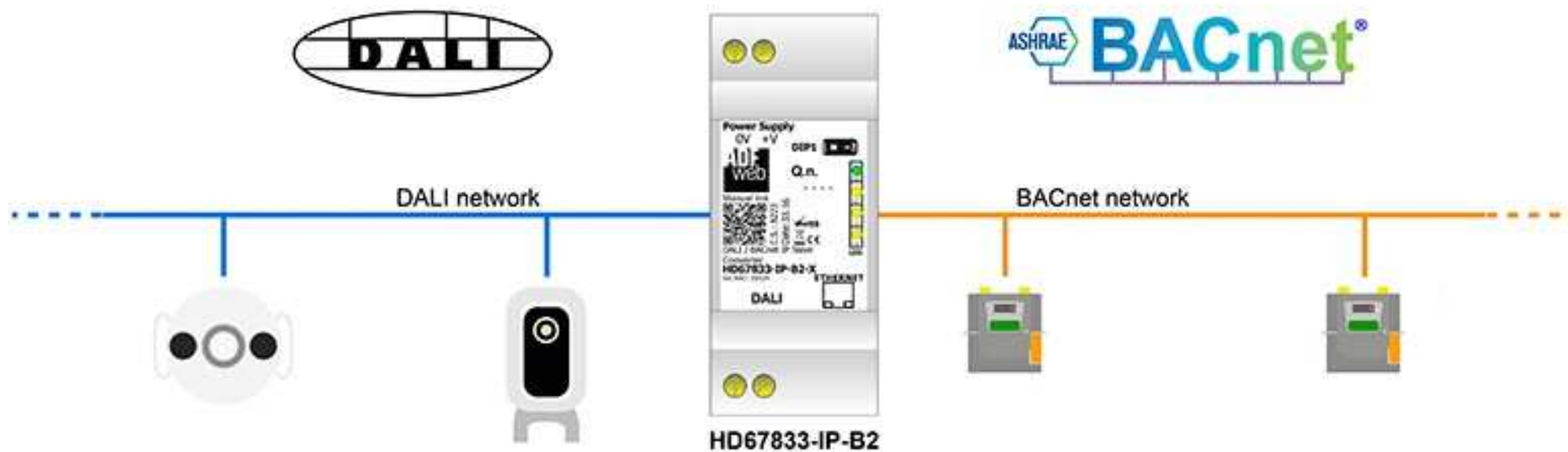

ADFweb.com



+39 0438 309 131



+39 349 440 9592



support@adfweb.com

**CONNECTION SCHEME:**

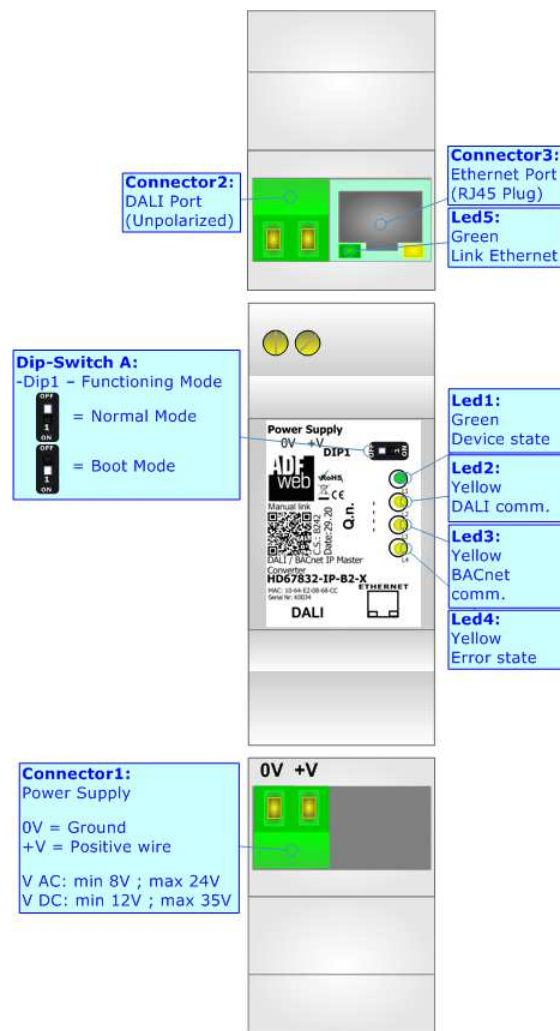

Figure 1a: Connection scheme for HD67832-IP-B2

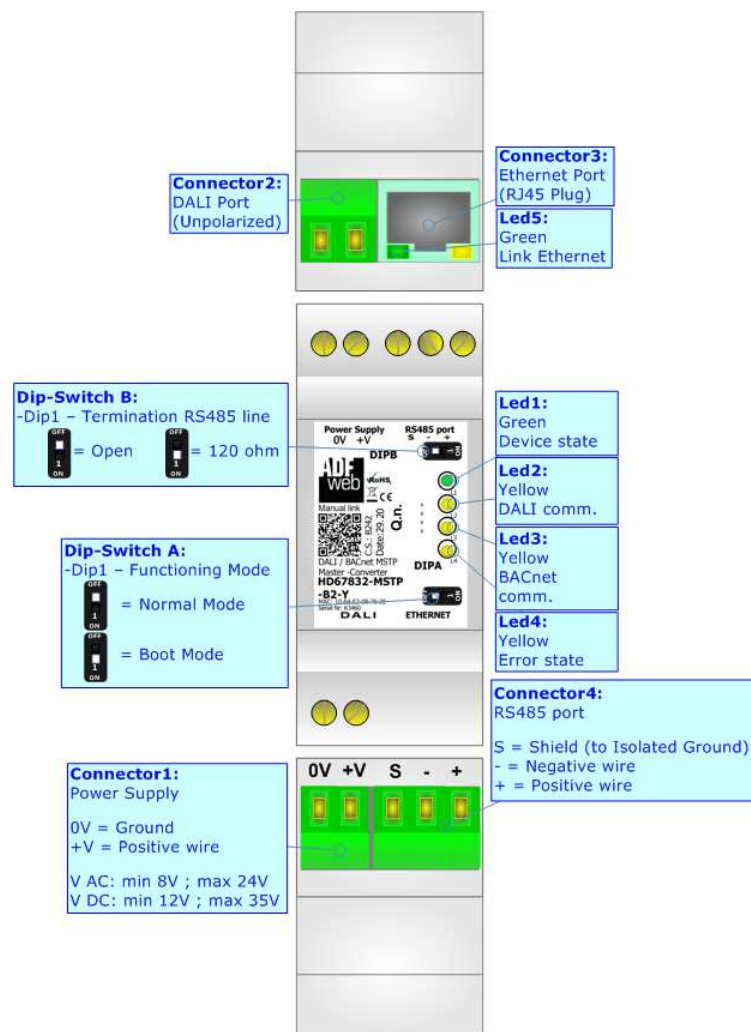

Figure 1b: Connection scheme for HD67832-MSTP-B2

**CHARACTERISTICS:**

The HD67832-xxx-B2 is a DALI / BACnet Master - Converter.

It has the following characteristics:

- Up to 64 devices on DALI bus;
- Configurator for DALI network/devices;
- Isolation between DALI – RS485, Power Supply – RS485. Additional isolation Power Supply – DALI for HD67832-xxx-B2 version;
- Two-directional information between DALI bus and BACnet bus;
- Mountable on 35mm Rail DIN;
- Wide power supply input range: 8...24V AC or 12...35V DC;
- Wide temperature range: -40°C / 85°C [-40°F / +185°F].

**CONFIGURATION:**

You need "DALI Console" software on your PC in order to perform the following:



- Configure the DALI network;
- Setup the DALI devices (groups, scenes, IDs, ...);
- Test DALI communication.

You need Compositor SW67832-xxx-B2 software on your PC in order to perform the following:

- Define the parameter of BACnet line;
- Define the parameter of DALI line;
- Update the device.

**POWER SUPPLY:**

The devices can be powered at 8...24V AC and 12...35V DC. For more details see the two tables below.

VAC 		VDC 	
Vmin	Vmax	Vmin	Vmax
8V	24V	12V	35V

Consumption at 24V DC:

Device	Consumption [W/VA]
HD67832-xxx-B2	3.5

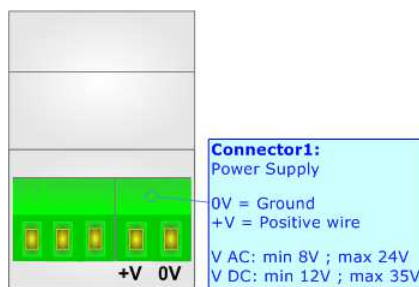
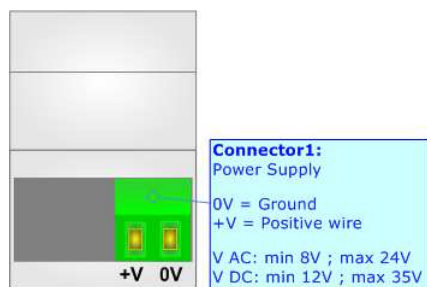

**Caution: Not reverse the polarity power**

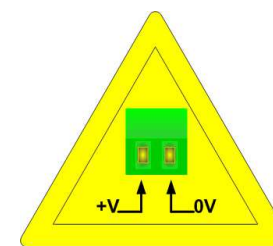

HD67832-xxx-B2



### FUNCTION MODES:

The device has got two functions mode depending of the position of the 'Dip1 of Dip-Switch A':

- The first, with 'Dip1 of Dip-Switch A' at "OFF" position, is used for the normal working of the device.
- The second, with 'Dip1 of Dip-Switch A' at "ON" position, is used for upload the Project and/or Firmware.

For the operations to follow for the updating, see 'UPDATE DEVICE' section.

According to the functioning mode, the LEDs will have specifics functions, see 'LEDS' section.

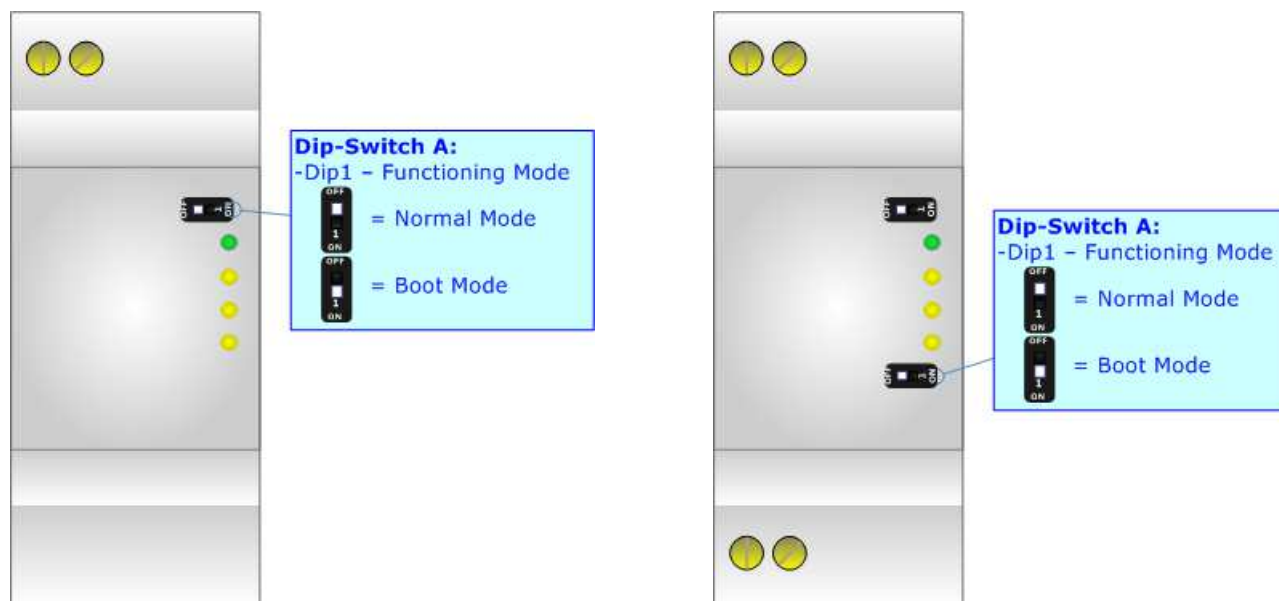

**LEDS:**

The device has got five LEDs that are used to give information of the functioning status.  
 The various meanings of the LEDs are described in the table below.

LED	Normal Mode	Boot Mode
1: Device State (green)	Blinks slowly (~1Hz)	<b>Blinks quickly:</b> Boot state <b>Blinks very slowly (~0.5Hz):</b> update in progress
2: DALI communication (yellow)	Blinks when DALI communication is running	<b>Blinks quickly:</b> Boot state <b>Blinks very slowly (~0.5Hz):</b> update in progress
3: BACnet communication (yellow)	Blinks when BACnet communication is running	<b>Blinks quickly:</b> Boot state <b>Blinks very slowly (~0.5Hz):</b> update in progress
4: Error State (yellow)	<b>ON:</b> An error in the communication busses occurs <b>OFF:</b> No errors are present	<b>Blinks quickly:</b> Boot state <b>Blinks very slowly (~0.5Hz):</b> update in progress
5: Link Ethernet (green)	<b>ON:</b> Ethernet cable connected <b>OFF:</b> Ethernet cable disconnected	<b>ON:</b> Ethernet cable connected <b>OFF:</b> Ethernet cable disconnected

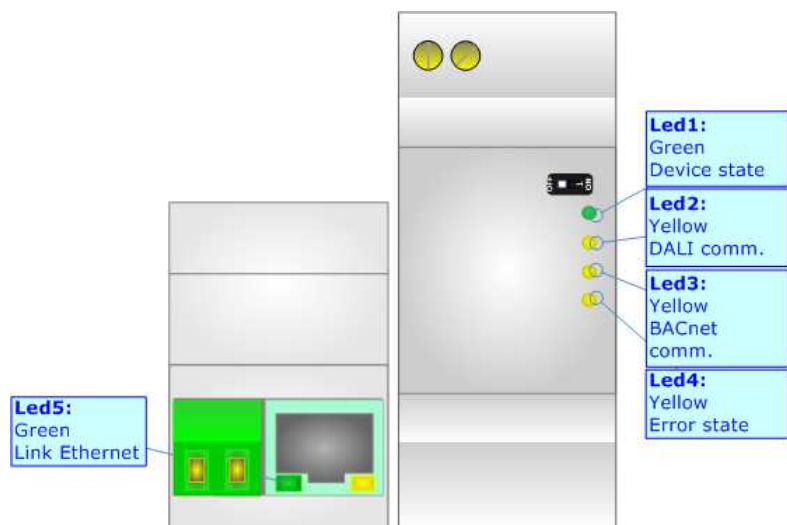

**DALI:**

DALI stands for “Digital Addressable Lighting Interface” and it is an interface protocol for digital communication between electronic lighting equipment (electronic ballasts, transformers, etc.). With the right choice of individual DALI components an extremely wide range of requirements can be met, from operating the lighting system from a simple light switch to lighting management systems for entire office complexes with thousands of light sources. Using ADFweb.com’s DALI converters, any light source, including incandescent lamps, fluorescent lamps, high-intensity discharge lamps and even LEDs, can be controlled irrespective of whether they are installed in an office, a restaurant or a street light.

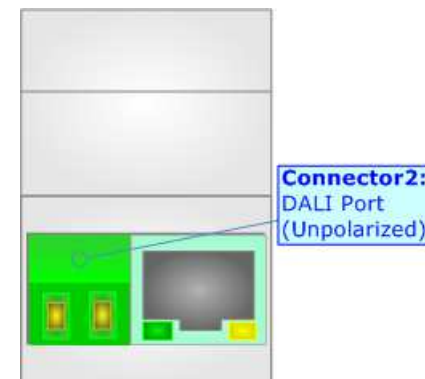

Characteristics	Description
Medium	Shielded Twisted Pair
Topology	Linear, Star or mixed
Device power consumption	Max 250 mA
DALI voltage	9.5 V – 22.5 V (typical 16 V)
Maximum cable length	300 m (1.5 mm <sup>2</sup> wire)
Maximum number of DALI devices	64
Baud rate	1200 bps
Maximum number of DALI groups	16
Maximum number of DALI scenes	16

**RS485 (for BACnet MS/TP):**

For terminate the RS485 line with a 120Ω resistor it is necessary to put ON dip 1, like in figure.

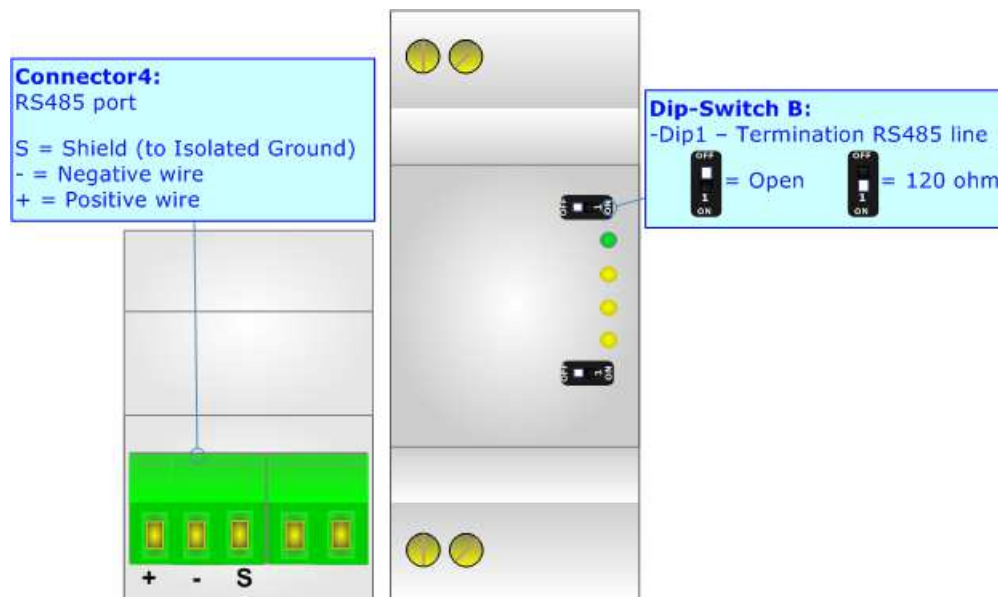

The maximum length of the cable should be 1200m (4000 feet).

Here some codes of cables:

- Belden: p/n 8132 - 2x 28AWG stranded twisted pairs conductor + foil shield + braid shield;
- Belden p/n 82842 - 2x 24AWG stranded twisted pairs conductor + foil shield + braid shield;
- Tasker: p/n C521 - 1x 24AWG twisted pair conductor + foil shield + braid shield;
- Tasker: p/n C522 - 2x 24AWG twisted pairs conductor + foil shield + braid shield.

**ETHERNET:**

The Ethernet port is used for programming DALI network and for programming the device.

The Ethernet connection must be made using Connector2 of HD67832-xxx-B2 with at least a Category 5E cable. The maximum length of the cable should not exceed 100m. The cable has to conform to the T568 norms relative to connections in cat.5 up to 100 Mbps. To connect the device to an Hub/Switch is recommended the use of a straight cable, to connect the device to a PC is recommended the use of a cross cable.

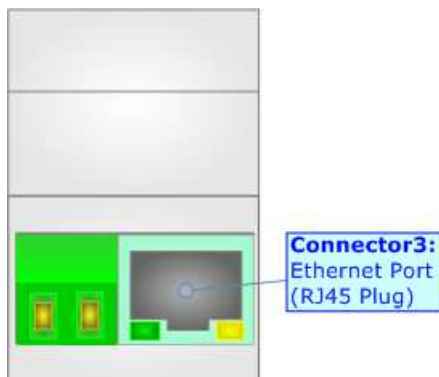

## USE OF COMPOSITOR SW67832:

To configure the Converter, use the available software that runs with Windows called SW67832. It is downloadable on the site [www.adfweb.com](http://www.adfweb.com) and its operation is described in this document. (*This manual is referenced to the last version of the software present on our web site*). The software works with MSWindows (XP, Vista, Seven, 8, 10; 32/64bit).

When launching the SW67832, the window below appears (Fig. 2).



### Note:

It is necessary to have installed .Net Framework 4.

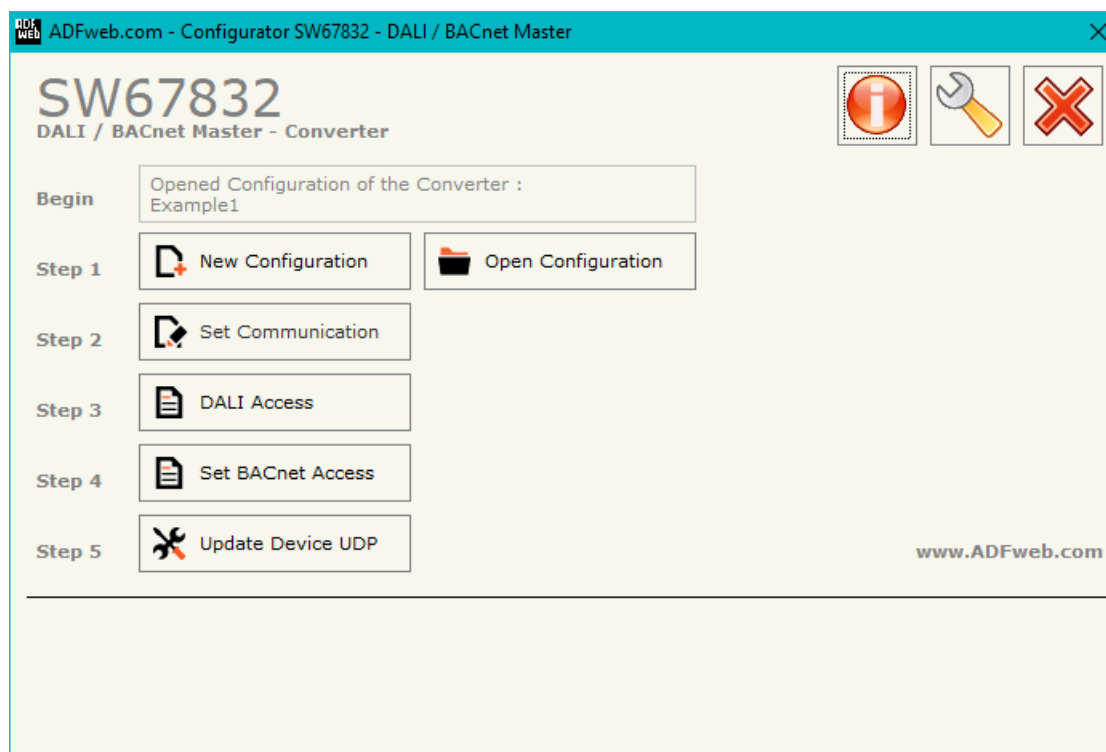
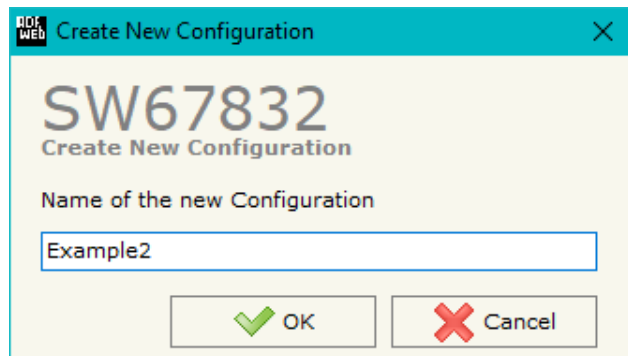

Figure 2: Main window for SW67832

**NEW CONFIGURATION / OPEN CONFIGURATION:**

The “**New Configuration**” button creates the folder which contains the entire device’s configuration.



A device’s configuration can also be imported or exported:

- To clone the configurations of a Programmable “DALI / BACnet Master - Converter” in order to configure another device in the same manner, it is necessary to maintain the folder and all its contents;
- To clone a project in order to obtain a different version of the project, it is sufficient to duplicate the project folder with another name and open the new folder with the button “**Open Configuration**”.

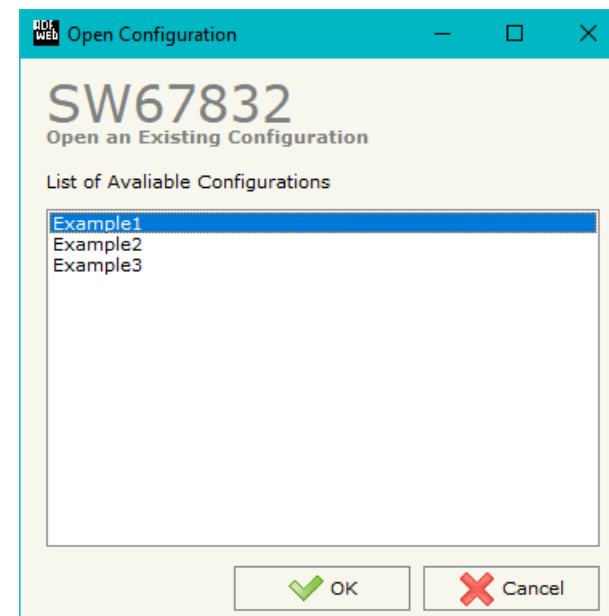

### SOFTWARE OPTIONS:

By pressing the “**Settings**” () button there is the possibility to change the language of the software and check the updatings for the compositor.

In the section “Language” it is possible to change the language of the software.

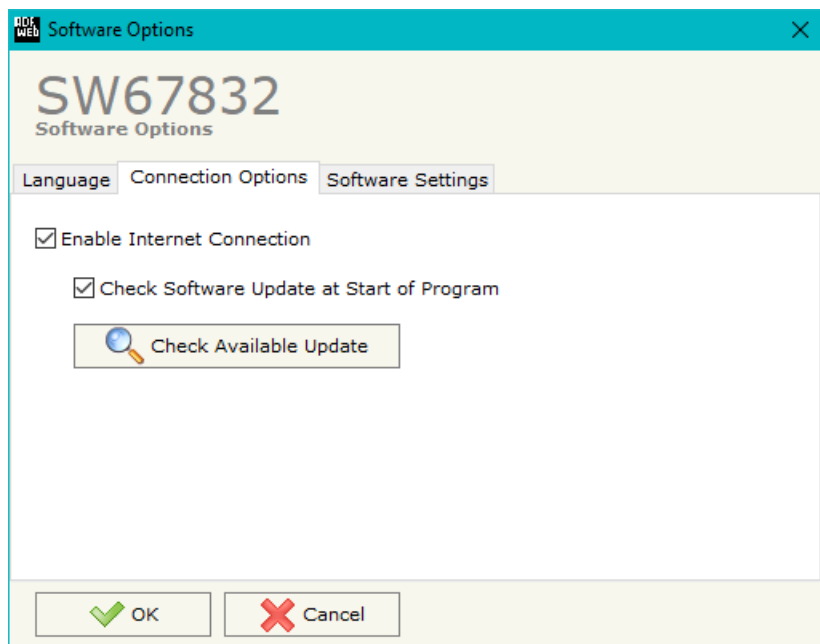

In the section “Connection Options”, it is possible to check if there are some updatings of the software compositor in ADFweb.com website. Checking the option “**Check Software Update at Start of Program**”, the SW67832 check automatically if there are updatings when it is launched.



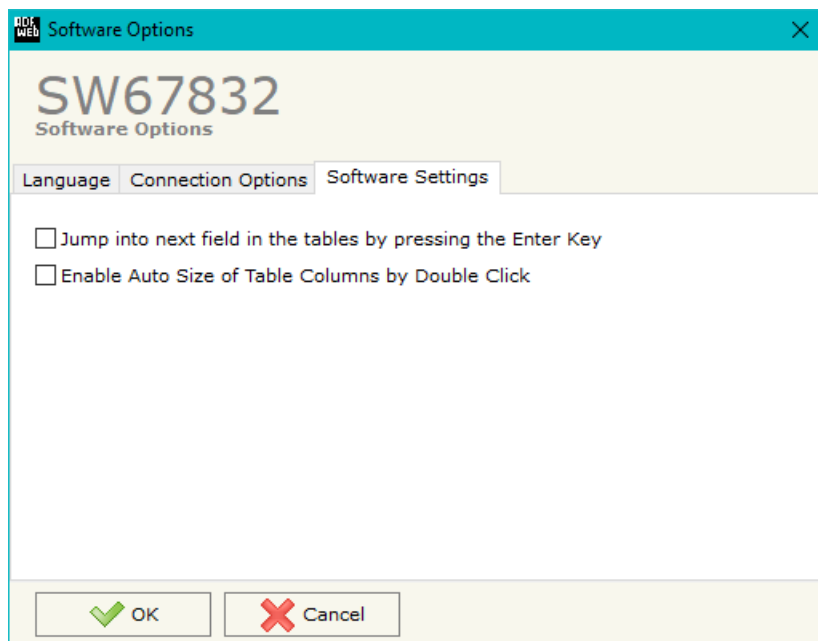

In the section "Software Settings", it is possible to enable/disable some keyboard's commands for an easier navigation inside the tables contained in the different sections of the software.

## SET COMMUNICATION:

This section define the fundamental communication parameters of BACnet Slave and DALI bus.

By Pressing the "**Set Communication**" button from the main window for SW67832 (Fig. 2) the window "Set Communication" appears (Fig. 3).

In the section "BACnet Type" it is possible to select the type of BACnet to use from:

- BACnet/IP (it uses Ethernet);
- BACnet MS/TP (it uses RS485).

If selected "BACnet/IP" the means of the fields for "BACnet" are:

- In the fields "**IP ADDRESS**" the IP address of BACnet/IP side of the converter is defined;
- In the fields "**SUBNET Mask**" the SubNet Mask of BACnet/IP side of the converter is defined;
- In the fields "**GATEWAY**" the default gateway of the network is defined. This feature can be enabled or disabled pressing the Check Box field. This feature is used for going out of the net;
- In the field "**Port**" the port used for BACnet communication is defined. The default port used for BACnet communication is 47808, but is possible to insert any value;
- In the field "**BACnet Device Name**" the name of BACnet/IP side of the converter is defined;
- In the field "**Device Identifier**" the device instance of BACnet/IP side of the converter is defined

If selected "BACnet MS/TP" the means of the fields for "BACnet" are:

- In the field "**Baudrate**" the baudrate of BACnet MS/TP side of the converter is defined;
- In the field "**Parity**" the parity of BACnet MS/TP side of the converter is defined;
- In the field "**BACnet Device Name**" the name of BACnet MS/TP side of the converter is defined;
- In the field "**MAC Address**" the MAC of BACnet MS/TP side of the converter is defined;
- The field "**Max Masters**" specifies the highest allowable address for master nodes. The value shall be less than or equal to 127;
- The field "**Max Info Frames**" specifies the maximum number of information frames the node may send before it must pass the token;

The screenshot shows the "Set Communication" window for device SW67832. The window is divided into several sections for configuration:

- BACnet Type:** A dropdown menu is set to "BACnet/IP".
- BACnet:** This section contains several fields:
  - IP ADDRESS:** 192 . 168 . 0 . 5
  - SUBNET Mask:** 255 . 255 . 255 . 0
  - GATEWAY:** An unchecked checkbox followed by the field 192 . 168 . 0 . 1.
  - Port:** 47808
  - BACnet Device Name:** devicename1
  - Device Identifier:** 1
- DALI:** This section contains:
  - DALI Console Port:** 10001
  - Enable DALI 2:** A checked checkbox.
  - Disable DALI Scan:** A checked checkbox.

At the bottom of the window are two buttons: "OK" (with a green checkmark icon) and "Cancel" (with a red X icon).

Figure 3: "Set Communication" window

- In the field "**Device Instance**" it is possible to assign a number to the BACnet node (used for the Device Instance);
- In the field "**Network**" the MS/TP network ID for the converter is defined.

The means of the fields for the "DALI" section are:

- In the field "**DALI Console Port**" the UDP port used for the communication with 'DALI Console' software is defined;
- If the field "**Enable DALI 2**" is checked, DALI 2 protocol is enabled.
- If the field "**Disable DALI Scan**" is checked, the automatic scan of DALI network is disabled;

**DALI ACCESS:**

By pressing the “**DALI Access**” button from the main window for SW67832 (Fig. 2) the window “Select the DALI Device Present in the Network” appears (Fig. 4).

This section is composed by three tables used to define the list of DALI devices to control, the DALI sensors to read and the DALI router’s functions.

**SELECT DEVICE**

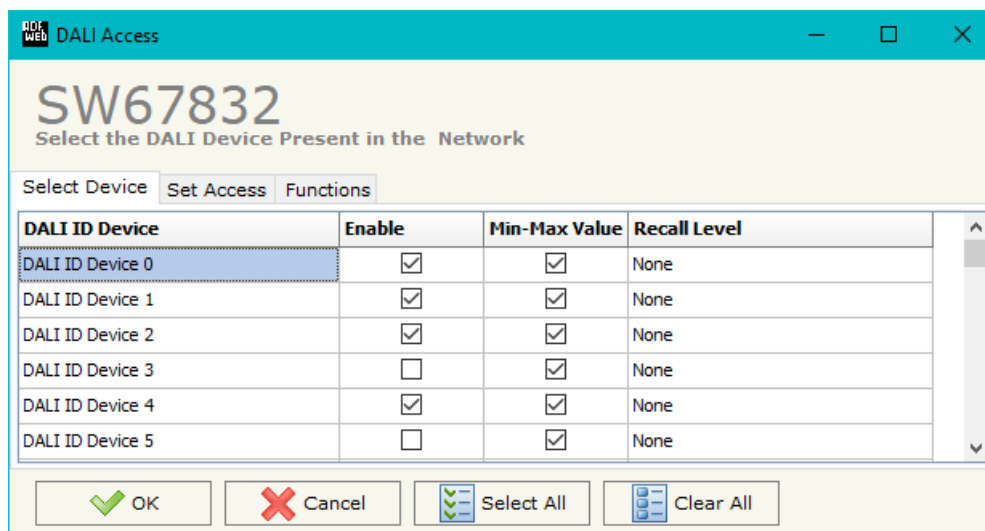

Figure 4a: “Select Device” window

The “**Select Device**” section (Fig. 4a) is used to list the DALI ballast to read/write. The means of the fields are:

- If the field “**Enable**” is checked, the DALI ballast is present in the network and connected to the converter;
- If the field “Min-Max Value” is checked, the DALI ballast will be dimmed only between the configured minimum and maximum light levels;
- In the field “Recall Level” the light level to command when the ballast is toggled (ON/OFF) is defined. It is possible to define:
  - None: function not enabled;
  - Recall Min-Max Level for Switch: the DALI device is toggled between configured minimum and maximum light levels;
  - Recall Old Value Level for Switch: the DALI device is toggled between 0 and last light level.

**SET ACCESS**

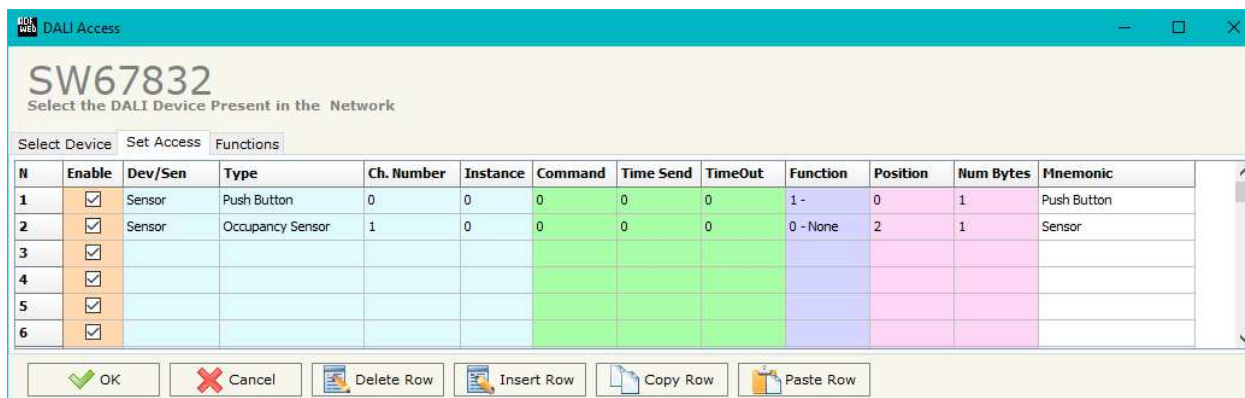

Figure 4b: "Set Access" window

The "Set Access" section (Fig. 4b) is used to list the DALI sensors to read and the DALI commands to send to the DALI ballasts. The means of the fields are:

- If the field "Enable" is checked, the DALI device/sensor is enabled;
- In the field "Dev/Sen" the DALI node is defined;
- In the field "Type" the type of DALI node to read/write is defined;
- In the field "Ch. Number" the ID of the DALI node is defined;
- In the field "Instance" the instance of the DALI node is defined;
- In the field "Command" the command code to send is defined. If not used, this column can be set to '0';
- In the field "Time Send" the delay in ms between the commands is defined. If not used, this column can be set to '0';
- In the field "TimeOut" the timeout in ms for the reception of the response is defined. If not used, this column can be set to '0';
- In the field "Function" the DALI function to recall is define. This feature is used to control DALI ballasts automatically from a DALI 2 device as a DALI router;
- In the field "Position" the byte of the internal memory array where mapping the data is defined;
- In the field "Num Bytes" the dimension of the data is defined;
- In the field "Mnemonic" a description of the row is defined.



**Note:**

This table is not required if the HD67832-B2 is used to communicate with DALI 1 devices only.

**FUNCTIONS**

N	Function	Condition	Event / Value	Channel	Brightness	Next Function	Mnemonic
1	Toggle	When Equal to Value	Button Pressed	DALI Group 1	100	0	ON/OFF
2							
3							
4							
5							

Figure 4c: "Functions" window

The "**Functions**" section (Fig. 4c) is used to list the DALI function to control the DALI ballasts in relation to the data from DALI 2 devices (buttons, sensors, exc.) like a DALI router. The means of the fields are:

- In the field "**Function**" the DALI operation to execute is defined;
- In the field "**Condition**" the logic operation to apply on the data is defined;
- In the field "**Event / Value**" the type of event received from the DALI 2 devices is defined;
- In the field "**Channel**" the DALI ballast/group to control is defined;
- In the field "**Brightness**" the light level to command is defined;
- In the field "**Next Function**" it is possible to concatenate another function;
- In the field "**Mnemonic**" a description of the row is defined.

## SET BACNET ACCESS:

By Pressing the "Set BACnet Access" button from the main window of SW67832 (Fig. 2), the window "Set BACnet Access" appears (Fig. 5). The window is divided in two parts, the "BACnet Read" that contains the BACnet objects that the converter reads from the BACnet devices and "BACnet Write" that contains the BACnet objects that the converter writes into the BACnet devices.

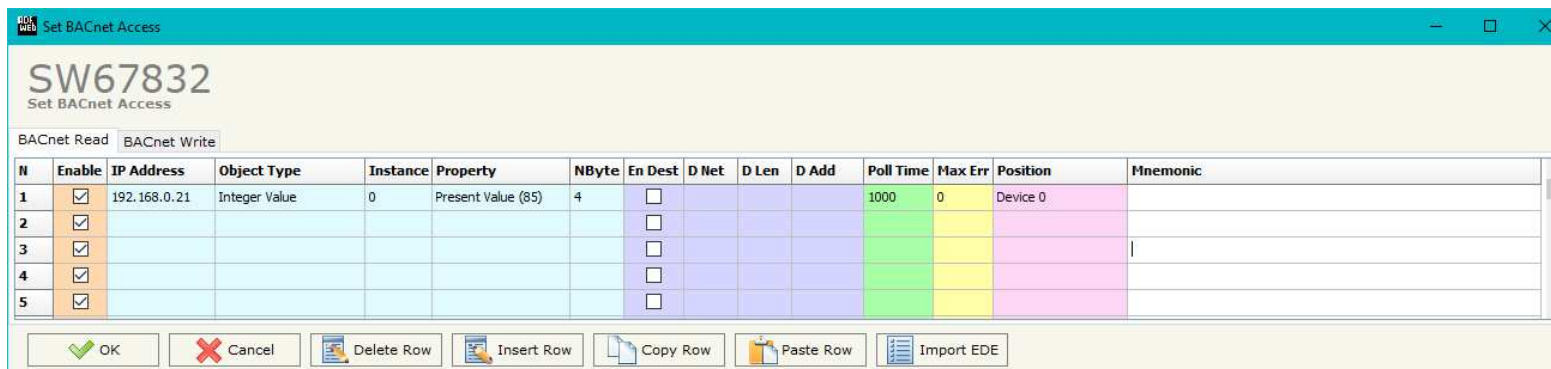

Figure 5a: "Set BACnet Access → BACnet Read" window

The means of the fields in the window "BACnet in Read" are the following:

- If the field "Enable" is checked, the BACnet variable is enabled;
- In the field "IP Address" the IP address of the device that contains the data to be read is defined;
- In the field "Object Type" the object to be read is defined;
- In the field "Instance" the instance number of the object is defined;
- In the field "Property" the property to be read is defined;
- In the field "NByte" the number of bytes of the BACnet object is defined;
- By checking the field "En Dest" it is possible to enable the Destination Network (D Net), Destination Length (D Len) and Destination Address (D Adr). These informations are used for make a request to other segments of network (through a BACnet router);
- In the field "D Net" the destination network (from 1 to 65535) is defined;
- In the field "D Len" the length of "D Add" field (1 or 2 or 6) is defined;
- In the field "D Add" the address of the endpoint is defined. If "D Len" is '1' it is possible to insert a number from 1 to 255; if "D Len" is '2' it is possible to insert a number from 1 to 65535; if "D Len" is '6' it is possible to insert an IP and port in this format "192.168.2.188:47808";

- In the field "**Poll Time**" the frequency of the request is defined (in ms);
- In the field "**Max Error**" the number of consecutive errors that the Master waits before resetting the data for the specific requests is defined;
- In the field "**Position**" the starting byte of the internal memory array where mapping the data read is defined;
- In the field "**Mnemonic**" a description of the data inserted in the row is defined.



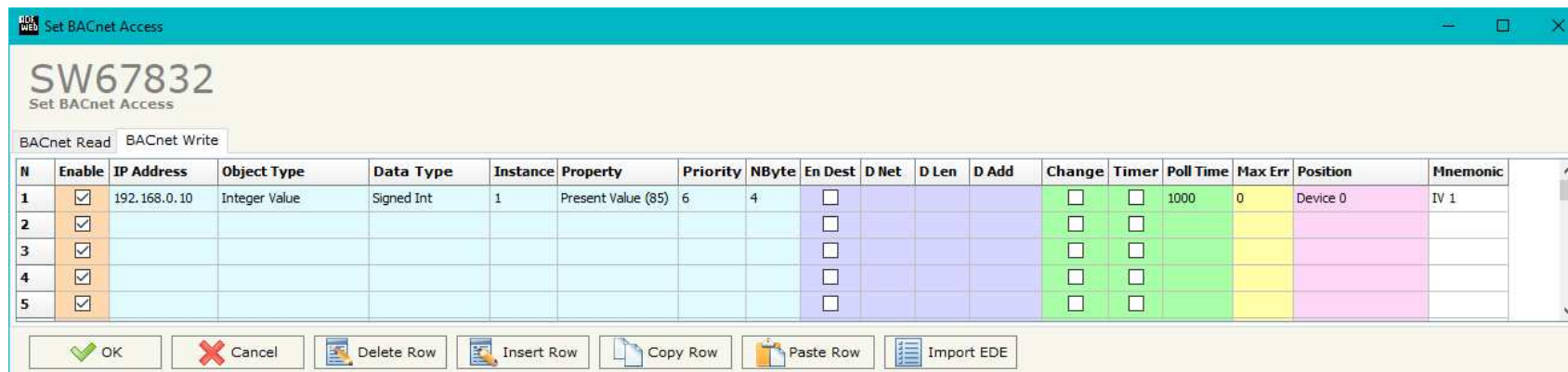

Figure 5b: "Set BACnet Access → BACnet Write" window

The means of the fields in the window "BACnet in Write" are the following:

- If the field "Enable" is checked, the BACnet variable is enabled;
- In the field "IP Address" the IP address of the slave that contains the data to be written is defined;
- In the field "Object Type" the object to be written is defined;
- In the field "Data Type" the type of data to write is defined;
- In the field "Instance" the instance number of the object is defined;
- In the field "Property" the property to be read is defined;
- In the field "Priority" the priority of the BACnet request is defined;
- In the field "NByte" the number of bytes of the BACnet object is defined;
- By checking the field "En Dest" it is possible to enable the Destination Network (D Net), Destination Length (D Len) and Destination Address (D Adr). These informations are used for make a request to other segments of network (through a BACnet router);
- In the field "D Net" the destination network (from 1 to 65535) is defined;
- In the field "D Len" the length of "D Add" field (1 or 2 or 6) is defined;
- In the field "D Add" the address of the endpoint is defined. If "D Len" is '1' it is possible to insert a number from 1 to 255; if "D Len" is '2' it is possible to insert a number from 1 to 65535; if "D Len" is '6' it is possible to insert an IP and port in this format "192.168.2.188:47808";
- By checking the field "Change" the BACnet write request is made only if data from DALI is changed; otherwise (if is selected the field "Timer") it is sent cyclically, using the "Poll Time" defined;

- In the field "**Max Error**" the number of consecutive errors that the Master waits before stopping the specific requests is defined;
- In the field "**Position**" the starting byte of the internal memory array from which taking the data to write is defined;
- In the field "**Mnemonic**" a description of the data inserted in the row is defined.

### UPDATE DEVICE:

By pressing the **“Update Device”** button, it is possible to load the created Configuration into the device; and also the Firmware, if necessary.

If you don't know the actual IP address of the device you have to use this procedure:

- Turn OFF the Device;
- Put Dip1 of 'Dip-Switch A' in ON position;
- Turn ON the device
- Connect the Ethernet cable;
- Insert the IP **“192.168.2.205”**;
- Select which operations you want to do;
- Press the **“Execute update firmware”** button to start the upload;
- When all the operations are “OK”, close the windows;
- Put Dip1 of 'Dip-Switch A' at OFF position.

If you know the actual IP address of the device, you have to use this procedure:

- Turn ON the Device with the Ethernet cable inserted;
- Insert the actual IP of the Converter;
- Select which operations you want to do;
- Press the **“Execute update firmware”** button to start the upload;
- When all the operations are “OK”, the device automatically goes at Normal Mode.

At this point the configuration/firmware on the device is correctly update.

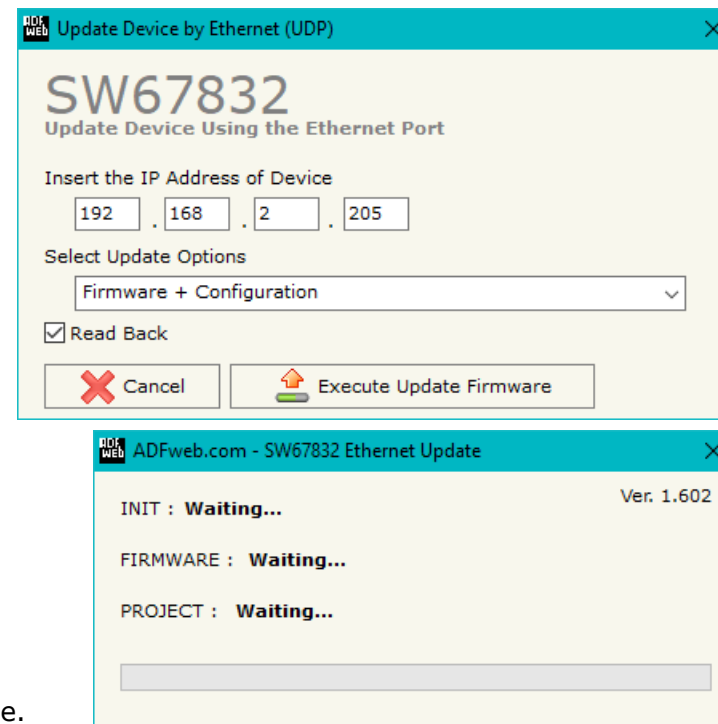





Figure 6: "Update device" windows

 **Note:**  
When you install a new version of the software, if it is the first time it is better you do the update of the Firmware in the HD67832 device.

 **Note:**  
When you receive the device, for the first time, you also have to update the Firmware in the HD67832 device.

 **Warning:**  
If Fig. 7 appears when you try to do the Update try these points before seeking assistance:

- Try to repeat the operations for the updating;
- Try with another PC;
- Try to restart the PC;
- Check the LAN settings;
- Check the Wi-Fi settings;
- If you are using the program inside a Virtual Machine, try to use in the main Operating System;
- If you are using Windows Seven, Vista, 8 or 10 make sure that you have the administrator privileges;
- In case you have to program more than one device, using the "UDP Update", you have to cancel the ARP table every time you connect a new device on Ethernet. For do this you have to launch the "Command Prompt" and write the command "arp -d". Pay attention that with Windows Vista, Seven, 8, 10 you have to launch the "Command Prompt" with Administrator Rights;
- Pay attention at Firewall lock.

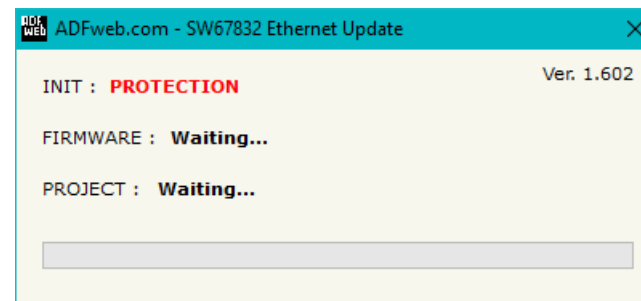
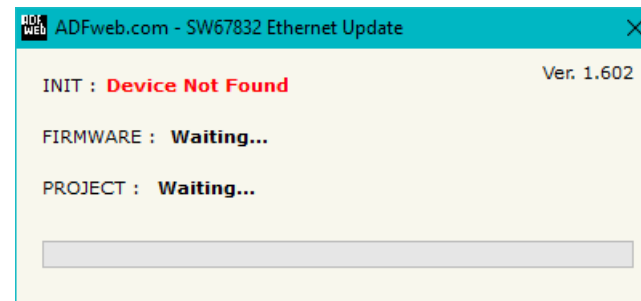

Figure 7: "Protection" window

 In the case of HD67832 you have to use the software "SW67832": [www.adfweb.com/download/filefold/SW67832.zip](http://www.adfweb.com/download/filefold/SW67832.zip).

**USE OF DALI CONSOLE SOFTWARE:**

To configure DALI network and test the communication, it is possible to use the available software that runs with Windows called "DALI Console". It is downloadable on the site [www.adfweb.com](http://www.adfweb.com) and its operation is described in this document. (This manual is referenced to the last version of the software present on our web site). The software works with MSWindows (XP, Vista, Seven, 8, 10; 32/64bit).

When launching the DALI Console, the window below appears (Fig. 8).

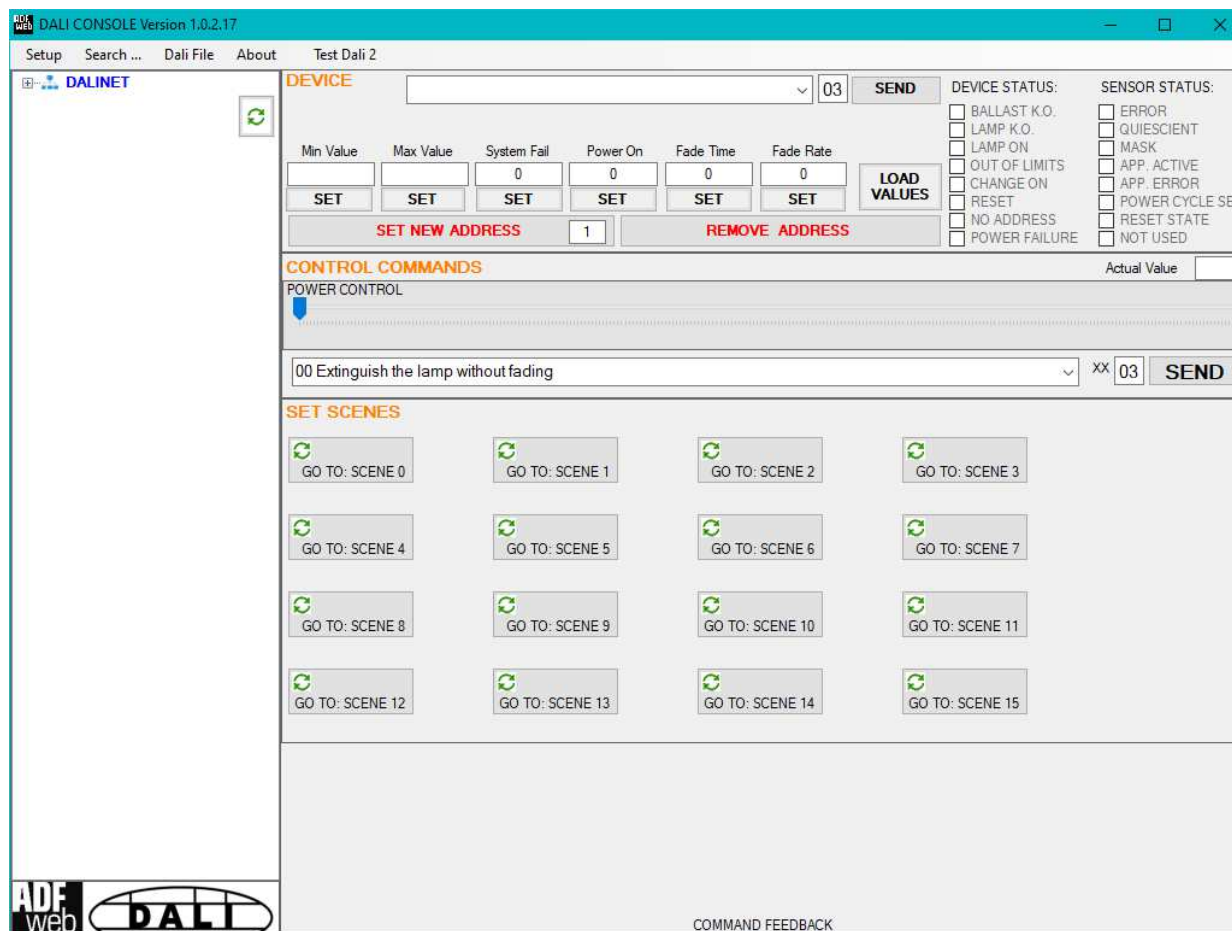
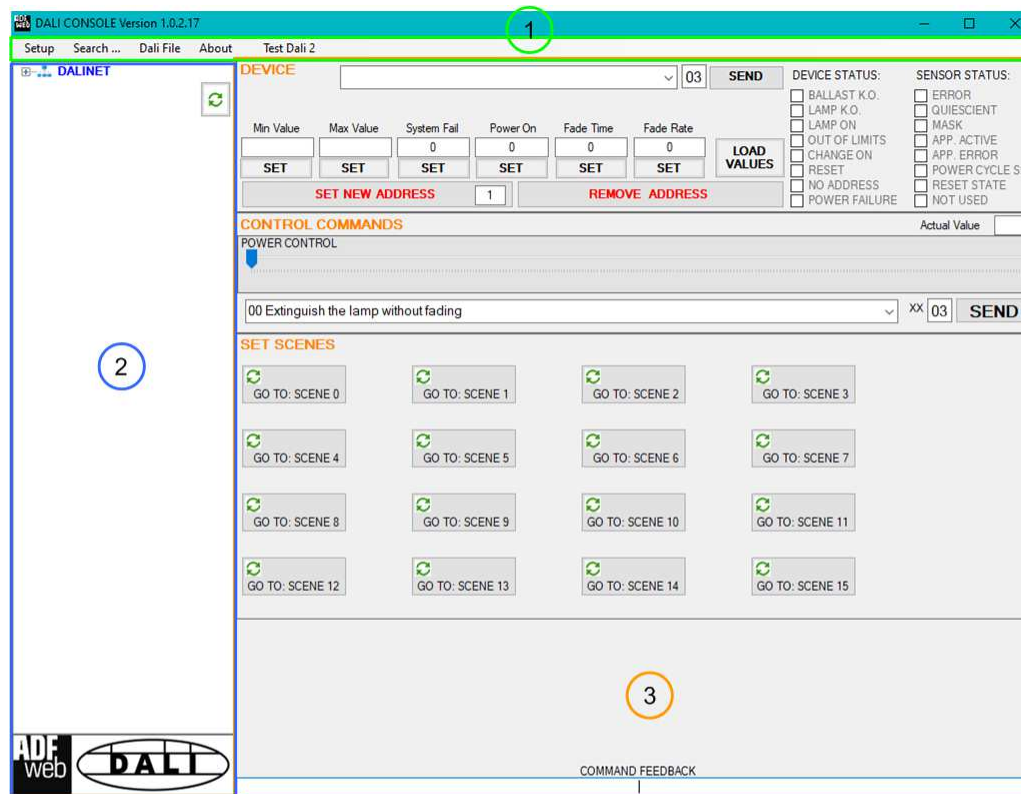

Figure 8: Main window for DALI Console

### STRUCTURE OF THE SOFTWARE:

The software layout is very simple and it is structured in this way:

- **“Menu bar”** (Fig. 9, Point 1): it is possible to open the setup window (“Setup” menu), scan the DALI network and program automatically the IDs (“Search...” menu), export/import the results of the communication (“Dali File” menu), see the informations about the DALI Console software (“About” menu) and test DALI 2 communication (“Test Dali 2” menu).
- **“Network view”** (Fig. 9, Point 2): it is possible to see all the DALI devices/sensors connected to the HD67832 converter, the groups and the scenes set;
- **“Settings / commands view”** (Fig. 9, Point 3): it is possible to set and manage the parameters to the single DALI device/sensor, to the groups or for the full network.



(1) Menu bar

(2) Network view

(3) Settings / commands view

Figure 9: Structure of DALI Console software

**SETUP:**

This section defines the parameters of the HD67832 converter.

By Pressing the "Setup" button from the menu bar of the DALI Console software, the "SETUP" window appears (Fig. 10).

Setup	
<input checked="" type="radio"/> LAN CONNECTION	
<input type="radio"/> SERIAL CONNECTION	
IP ADDRESS	192.168.2.115
DEVICE PORT	10000
CONSOLE PORT	10001
<input type="radio"/> SCI 1 Protocol	<input type="checkbox"/> DALI 1 ONLY
<input type="radio"/> SCI 2 Protocol	<input type="checkbox"/> DISABLE AUTOMATIC SCAN
<input checked="" type="radio"/> SCI 3 Protocol	<input checked="" type="checkbox"/> AutoRefresh
CLOSE SETUP	

Figure 10: "Setup" window

The means of the fields for the "SETUP" window are:

- In the field "**DEVICE IP ADDRESS**" the IP address set inside the converter is defined;
- In the field "**DEVICE PORT**" the communication port is defined. It is fixed to '10000';
- In the field "**CONSOLE PORT**" the communication port for the DALI commands is defined. It is the one defined in the field "DALI Console Port" of the section "Set Communication" of SW67832;
- In the fields "**SCI x Protocol**" the type of Ethernet communication used is defined. It is possible to leave the default setting;
- If the field "**DALI 1 ONLY**" is checked, the converter will manage just DALI 1 communication;
- If the field "**DISABLE AUTOMATIC SCAN**" is checked, the converter will stop the automatic scan of DALI network;
- If the field "**AutoRefresh**" is checked, the converter automatically refreshes the data when a command is sent.

**SEARCH:**

This section is used to scan the DALI network, discover the devices and address them consecutively. The options available under this menu are different:

- Full Device Search: this function will scan and address all the DALI devices;
- Partial Device Search: this function will scan and address only the DALI devices without ID;
- Full Sensor Search: this function will scan and address all the DALI sensors;
- Partial Sensor Search: this function will scan and address only the DALI sensors without ID;
- Scan Devices and Sensors: this function will read the data from all available DALI devices/sensors;
- Disable Polling: this function will stop the DALI readings;
- Enable Polling: this function will start the DALI readings.

**TEST DALI 2:**

This section is used to monitor the DALI 2 messages received by the converter. It allows to see the sensor that is communicating, the instance and the information available in the event.



## NETWORK SETTING:

By pressing the button in the Network view, it is possible to read the converter and check the DALI devices/sensors discovered, the groups set and the scenes configured.

By selecting the single DALI devices found, the single groups, the single scene or the entire DALI network, it is possible to manage and test the functioning of the network.

## DEVICES:

The means of the fields for "DEVICE INFO" are:

- In the field "**Device Type**" the type of DALI device is printed;
- In the field "**Software version**" the software version of the DALI device is printed;
- In the fields "**Power Range**" Min value, Actual value, Max value, System Fail value, Power On value, Fade Time and Fade Rate of the DALI device is defined. It is possible to read the actual value and set a new value;
- In the fields "**DEVICE STATUS**" the actual status of the DALI device is printed;
- In the field "**SET NEW ADDRESS**" it is possible to program a new ID to the DALI node;
- In the field "**REMOVE ADDRESS**" it is possible to delete the ID from the DALI node.

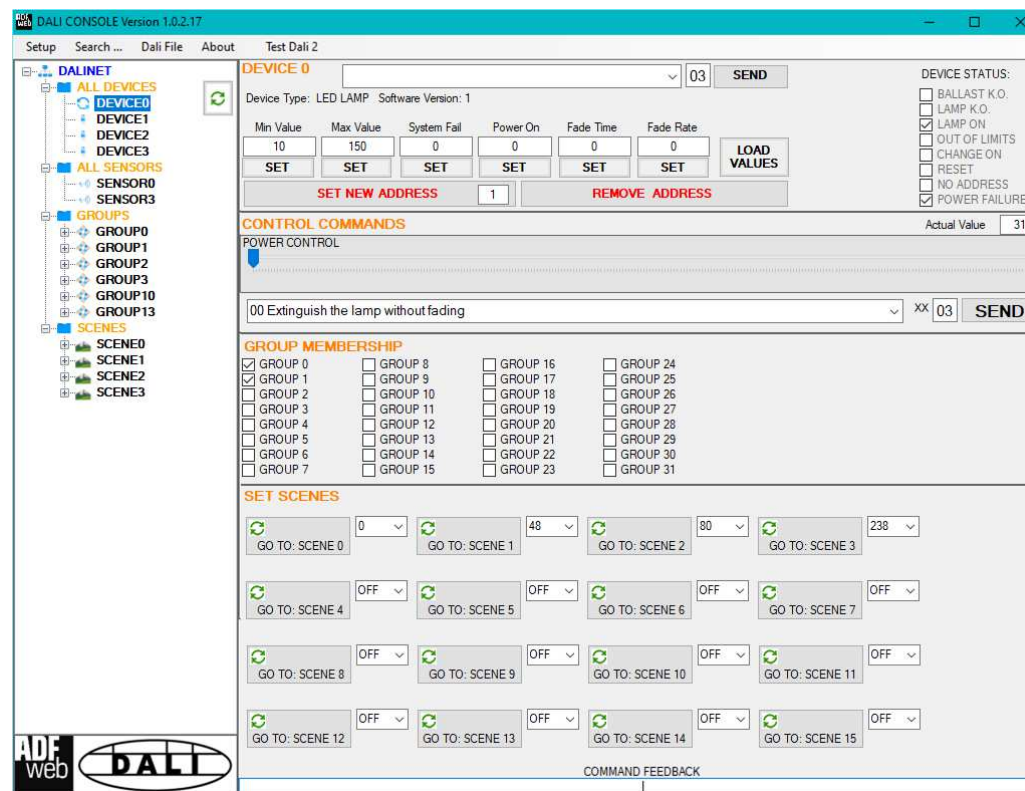

Figure 11: "Device settings" window

The means of the fields for the "CONTROL COMMANDS" section are:

- In the "**POWER CONTROL**" bar it is possible to change the actual ADV of the selected DALI device;
- In the field "**COMMAND**" it is possible to select a DALI command to send to the selected DALI device. For set commands, it is possible to insert the value to set in the field "**xx**". As soon as the command to send is selected, the command is sent: in order to send the same command more times, it is possible to press the "**SEND COMMAND**" button;
- In the field "**COMMAND FEEDBACK**" the response from the DALI device is printed.



**Note:**

This section is used to test the functioning of the DALI device in the network and to set specific parameters if needed (like new Minimum or Maximum ADV value).

In the "GROUP MEMBERSHIP" section it is possible to see the Groups which the selected DALI device is in. The checked checkboxes mean that the device is in the correspondent groups, the unchecked checkboxes mean that the device is not included in the correspondent groups. It is possible to change the group settings for the selected DALI device by checking/unchecking the correspondent checkboxes.

In the "SET SCENES" section it is possible to see the programmed scenes of the selected DALI device, program new ones and activate them:

- By pressing the buttons "**GO TO: SCENE X**" it is possible to activate the correspondent scene inside the selected DALI device; the programmed ADV for the selected scene is defined in the drop-down list on the right;
- By selecting a value into the drop-down lists next to the "GO TO: SCENE x" buttons, it is possible to set the ADV associated to the correspondent scene. It is possible to select:
  - Value between 0 and 255: the scene will have the defined value of ADV;
  - ACT: the scene will take the programmed ADV value into the "POWER CONTROL" bar;
  - OFF: the scene is disabled.

**SENSORS:**

The means of the fields for "SENSOR INFO" are:

- In the field "**Software version**" the software version of the DALI sensor is printed;
- In the field "**COMMAND**" it is possible to select a DALI command to send to the selected DALI sensor. For set commands, it is possible to insert the value to set in the field "**xx**". As soon as the command to send is selected, the command is sent: in order to send the same command more times, it is possible to press the "**SEND**" button;
- In the fields "**SENSOR STATUS**" the actual status of the DALI sensor is printed;
- In the field "**SET NEW ADDRESS**" it is possible to program a new ID to the DALI sensor;
- In the field "**REMOVE ADDRESS**" it is possible to delete the ID from the DALI sensor.

In the "GROUP MEMBERSHIP" section it is possible to see the Groups which the selected DALI sensor is in. The checked checkboxes mean that the device is in the correspondent groups, the unchecked checkboxes mean that the device is not included in the correspondent groups.

It is possible to change the group settings for the selected DALI sensor by checking/unchecking the correspondent checkboxes.

In the "SET INSTANCES" section it is possible to program the parameters for each instance available in the sensor. Each sensor's type has specific parameters defined in DALI 2 specifications.

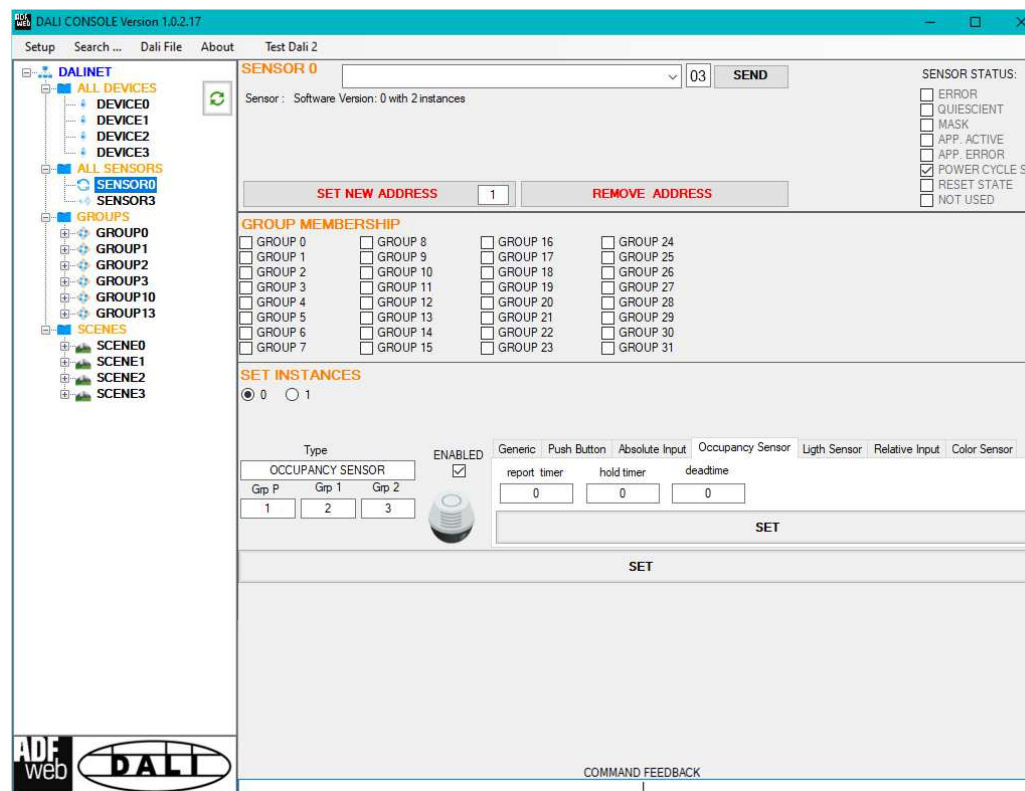



Figure 12: "Sensors settings" window

**GROUPS:**

The means of the fields for the "CONTROL COMMANDS" section are:

- In the "POWER CONTROL" bar it is possible to change the actual ADV of the selected DALI group;
- In the field "COMMAND" it is possible to select a DALI command to send to the selected DALI group. For set commands, it is possible to insert the value to set in the field "xx". As soon as the command to send is selected, the command is sent: in order to send the same command more times, it is possible to press the "SEND COMMAND" button;
- In the field "COMMAND FEEDBACK" the response from the DALI group is printed.

 **Note:** This section is used to test the functioning of the DALI groups in the network.

In the "SET SCENES" section it is possible to activate the programmed scenes to the selected group:

- By pressing the buttons "GO TO: SCENE X" it is possible to activate the correspondent scene inside the selected DALI group.

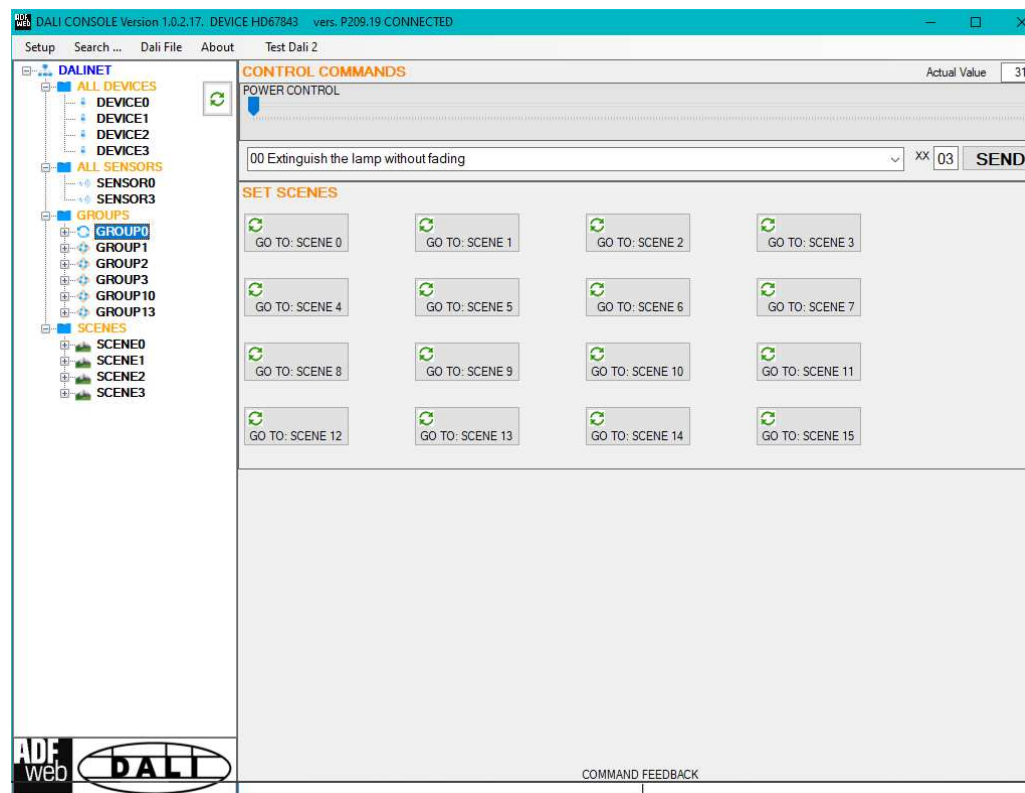

Figure 13: "Groups settings" window

**SCENES:**

By selecting a DALI scene from the Network view, it is possible to see the devices that have programmed the selected scene.

It is also possible to activate it by pressing the **“ACTIVATE SCENE X”** button.

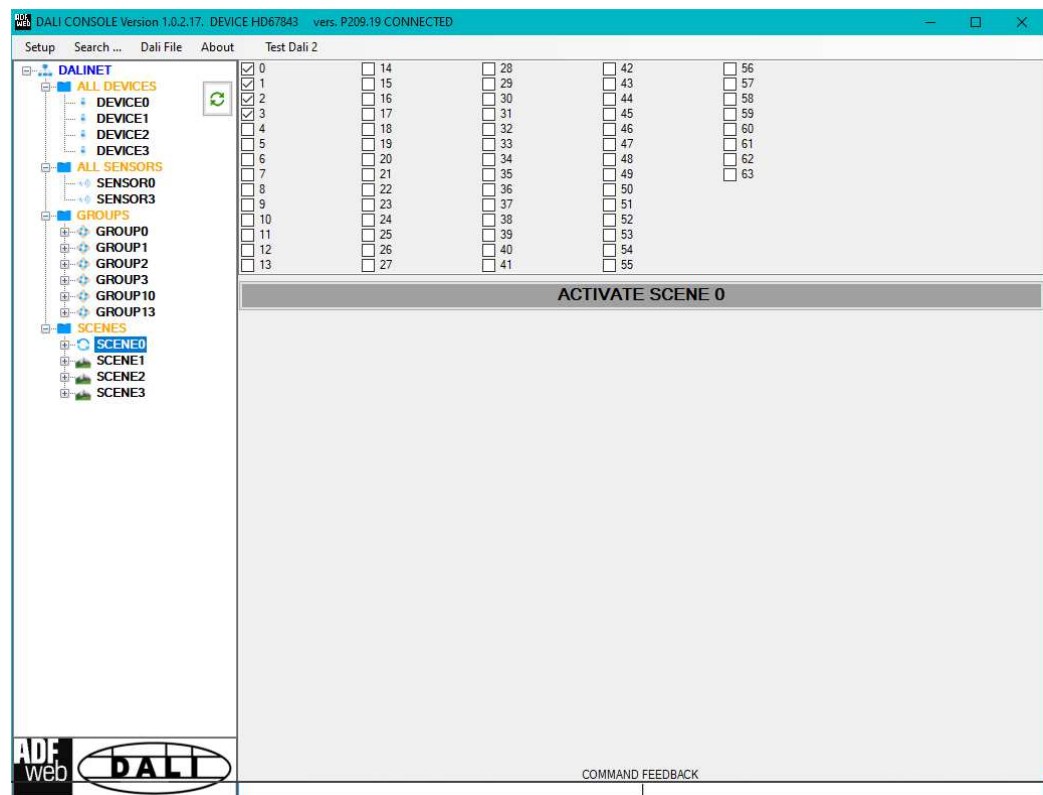



Figure 14: "Scenes settings" window

**ALL DEVICES (BROADCAST):**

The means of the fields for the "CONTROL COMMANDS" section are:

- In the "POWER CONTROL" bar it is possible to change the actual ADV of the entire DALI network;
- In the field "COMMAND" it is possible to select a DALI command to send to the entire DALI network. For set commands, it is possible to insert the value to set in the field "xx". As soon as the command to send is selected, the command is sent: in order to send the same command more times, it is possible to press the "SEND COMMAND" button;
- In the field "COMMAND FEEDBACK" the response from the DALI network is printed.

 Note: This section is used to test the functioning of the DALI network.

In the "SET SCENES" section it is possible to activate the programmed scenes into all the DALI devices that have them:

- By pressing the buttons "GO TO: SCENE X" it is possible to activate the correspondent scene in the DALI network. Only the devices that have it will accept the command.

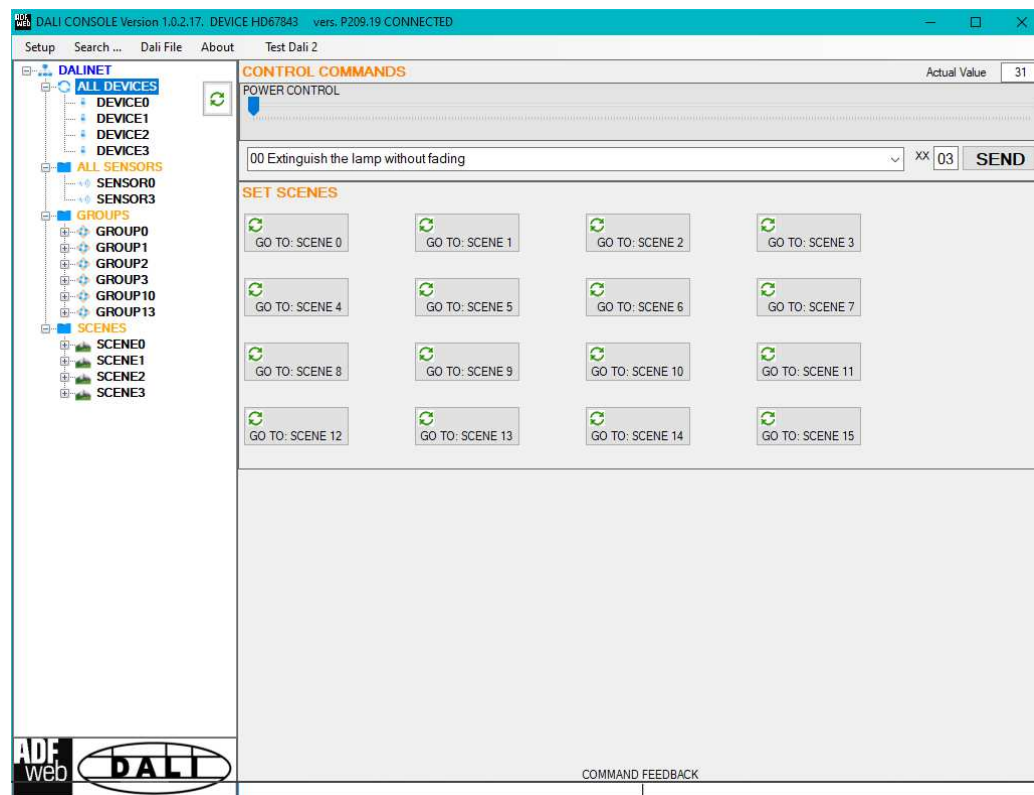
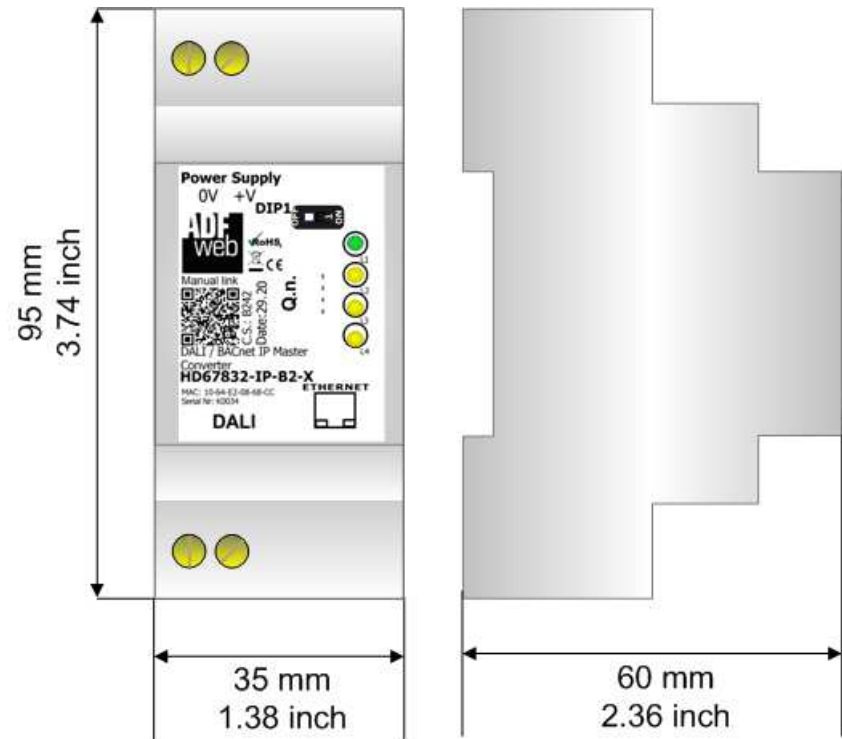

Figure 15: "Broadcast settings" window

**MECHANICAL DIMENSIONS:**



Housing: PVC  
Weight: 200g  
(Approx)

Figure 16: Mechanical dimensions scheme for HD67832-xxx-B2



### ORDERING INFORMATIONS:

The ordering part number is formed by a valid combination of the following:

**HD67832 - xx - B 2 - x**

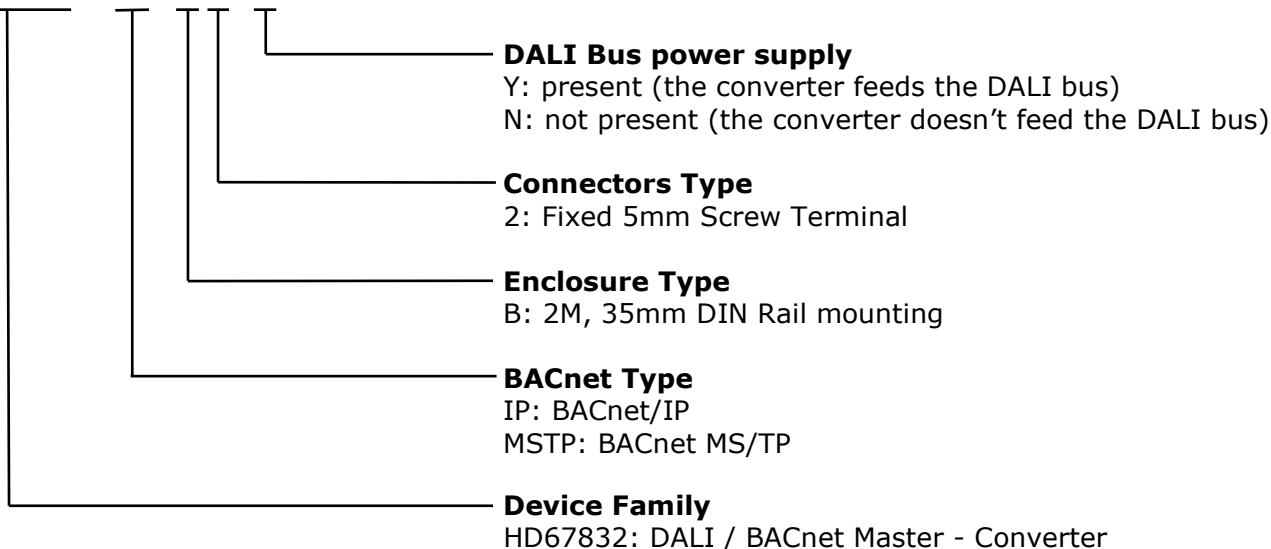

- Order Code: **HD67832-IP-B2-Y** - DALI / BACnet/IP Master – Converter (DALI bus power supply present)
- Order Code: **HD67832-IP-B2-N** - DALI / BACnet/IP Master – Converter (DALI bus power supply not present)
- Order Code: **HD67832-MSTP-B2-Y** - DALI / BACnet MS/TP Master – Converter (DALI bus power supply present)
- Order Code: **HD67832-MSTP-B2-N** - DALI / BACnet MS/TP Master – Converter (DALI bus power supply not present)

### ACCESSORIES:

- Order Code: **AC34011** - 35mm Rail DIN - Power Supply 220/240V AC 50/60Hz – 12 V DC
- Order Code: **AC34012** - 35mm Rail DIN - Power Supply 220/240V AC 50/60Hz – 24 V DC



**DISCLAIMER:**

All technical content within this document can be modified without notice. The content of the document is a under continual renewal. For losses due to fire, earthquake, third party access or other accidents, or intentional or accidental abuse, misuse, or use under abnormal conditions repairs are charged to the user. ADFweb.com S.r.l. will not be liable for accidental loss of use or inability to use this product, such as loss of business income. ADFweb.com S.r.l. shall not be liable for consequences of improper use.

**OTHER REGULATIONS AND STANDARDS:****WEEE INFORMATION**

Disposal of old electrical and electronic equipment (as in the European Union and other European countries with separate collection systems).

— This symbol on the product or on its packaging indicates that this product may not be treated as household rubbish. Instead, it should be taken to an applicable collection point for the recycling of electrical and electronic equipment. If the product is disposed correctly, you will help prevent potential negative environmental factors and impact of human health, which could otherwise be caused by inappropriate disposal. The recycling of materials will help to conserve natural resources. For more information about recycling this product, please contact your local city office, your household waste disposal service or the shop where you purchased the product.

**RESTRICTION OF HAZARDOUS SUBSTANCES DIRECTIVE**

The device respects the 2002/95/EC Directive on the restriction of the use of certain hazardous substances in electrical and electronic equipment (commonly referred to as Restriction of Hazardous Substances Directive or RoHS).

**CE MARKING**

The product conforms with the essential requirements of the applicable EC directives.

**WARRANTIES AND TECHNICAL SUPPORT:**

For fast and easy technical support for your ADFweb.com SRL products, consult our internet support at [www.adfweb.com](http://www.adfweb.com).  
Otherwise contact us at the address [support@adfweb.com](mailto:support@adfweb.com)

**RETURN POLICY:**

If while using your product you have any problem and you wish to exchange or repair it, please do the following:

- Obtain a Product Return Number (PRN) from our internet support at [www.adfweb.com](http://www.adfweb.com). Together with the request, you need to provide detailed information about the problem.
- Send the product to the address provided with the PRN, having prepaid the shipping costs (shipment costs billed to us will not be accepted).

If the product is within the warranty of twelve months, it will be repaired or exchanged and returned within three weeks. If the product is no longer under warranty, you will receive a repair estimate.



**ADFweb.com S.r.l.**  
Via Strada Nuova, 17  
IT-31010 Mareno di Piave  
TREVISO (Italy)  
Phone +39.0438.30.91.31  
Fax +39.0438.49.20.99  
[www.adfweb.com](http://www.adfweb.com)

