

User Manual

Revision 1.001
English

DeviceNet Slave / PROFIBUS Slave - Converter

(Order Code: HD67574-A1)

for Website information:

www.adfweb.com?Product=HD67574

for Price information:

www.adfweb.com?Price=HD67574-A1

Benefits and Main Features:

- ▶ Very easy to configure
- ▶ Low cost
- ▶ PROFIBUS Baudrate up to 12M
- ▶ Wide supply input range
- ▶ Isolation between two buses
- ▶ Industrial temperature range:
-40°C / 85°C (-40°F / 185°F)



HD67574-A1

For others Gateways / Bridges:

CANopen to Modbus

See also the following links:

- www.adfweb.com?Product=HD67001 (Modbus RTU Master)
- www.adfweb.com?Product=HD67502 (Modbus RTU Slave)
- www.adfweb.com?Product=HD67504 (Modbus TCP Master)
- www.adfweb.com?Product=HD67505 (Modbus TCP Slave)

For others Gateways / Bridges:

For **CAN bus 2.0A** and/or **CAN bus 2.0B to Modbus**

See also the following links:

- www.adfweb.com?Product=HD67011 (Modbus RTU Slave)
- www.adfweb.com?Product=HD67012 (Modbus RTU Master)
- www.adfweb.com?Product=HD67514 (Modbus TCP Slave)
- www.adfweb.com?Product=HD67515 (Modbus TCP Master)

Do you have an your customer protocol?

See the following links:

www.adfweb.com?Product=HD67003

Do you need to choose a device? do you want help?

Ask it to the following link:

www.adfweb.com?Cmd=helpme

INDEX:

	Page
INDEX	2
UPDATED DOCUMENTATION	2
REVISION LIST	2
WARNING	2
TRADEMARKS	2
SECURITY ALERT	3
EXAMPLE OF CONNECTION	4
CONNECTION SCHEME	5
CHARACTERISTICS	6
CONFIGURATION	6
POWER SUPPLY	7
FUNCTION MODES	8
LEDS	9
PROFIBUS	10
RS232	10
DEVICENET	11
USE OF COMPOSITOR SW67574	12
NEW PROJECT / OPEN PROJECT	12
SET COMMUNICATION	13
GSD FILE	13
UPDATE DEVICE	14
MECHANICAL DIMENSIONS	16
ORDER CODE	16
ACCESSORIES	16
DISCLAIMER	17
OTHER REGULATIONS AND STANDARDS	17
WARRANTIES AND TECHNICAL SUPPORT	18
RETURN POLICY	18
PRODUCTS AND RELATED DOCUMENTS	18

UPDATED DOCUMENTATION:

Dear customer, we thank you for your attention and we remind you that you need to check that the following document is:

- Updated
- Related to the product you own

To obtain the most recently updated document, note the “document code” that appears at the top right-hand corner of each page of this document.

With this “Document Code” go to web page www.adfweb.com/download/ and search for the corresponding code on the page. Click on the proper “Document Code” and download the updates.

To obtain the updated documentation for the product that you own, note the “Document Code” (Abbreviated written “Doc. Code” on the label on the product) and download the updated from our web site www.adfweb.com/download/

REVISION LIST:

Revision	Date	Author	Chapter	Description
1.000	03/02/2011	FI	All	First release version
1.001	14/01/2013	Nt & FI	All	Added new chapters

WARNING:

ADFweb.com reserves the right to change information in this manual about our product without warning. ADFweb.com is not responsible for any error this manual may contain.

TRADEMARKS:

All trademarks mentioned in this document belong to their respective owners.

SECURITY ALERT:**GENERAL INFORMATION**

To ensure safe operation, the device must be operated according to the instructions in the manual. When using the device are required for each individual application, legal and safety regulation. The same applies also when using accessories.

INTENDED USE

Machines and systems must be designed so the faulty conditions do not lead to a dangerous situation for the operator (i.e. independent limit switches, mechanical interlocks, etc.).

QUALIFIED PERSONNEL

The device can be used only by qualified personnel, strictly in accordance with the specifications.

Qualified personnel are persons who are familiar with the installation, assembly, commissioning and operation of this equipment and who have appropriate qualifications for their job.

RESIDUAL RISKS

The device is state of the art and is safe. The instrument can represent a potential hazard if they are inappropriately installed and operated by personnel untrained. These instructions refer to residual risks with the following symbol:

 This symbol indicates that non-observance of the safety instructions is danger for people to serious injury or death and / or the possibility of damage.

CE CONFORMITY

The declaration is made by us. You can send an email to support@adfweb.com or give us a call if you need it.

EXAMPLE OF CONNECTION:

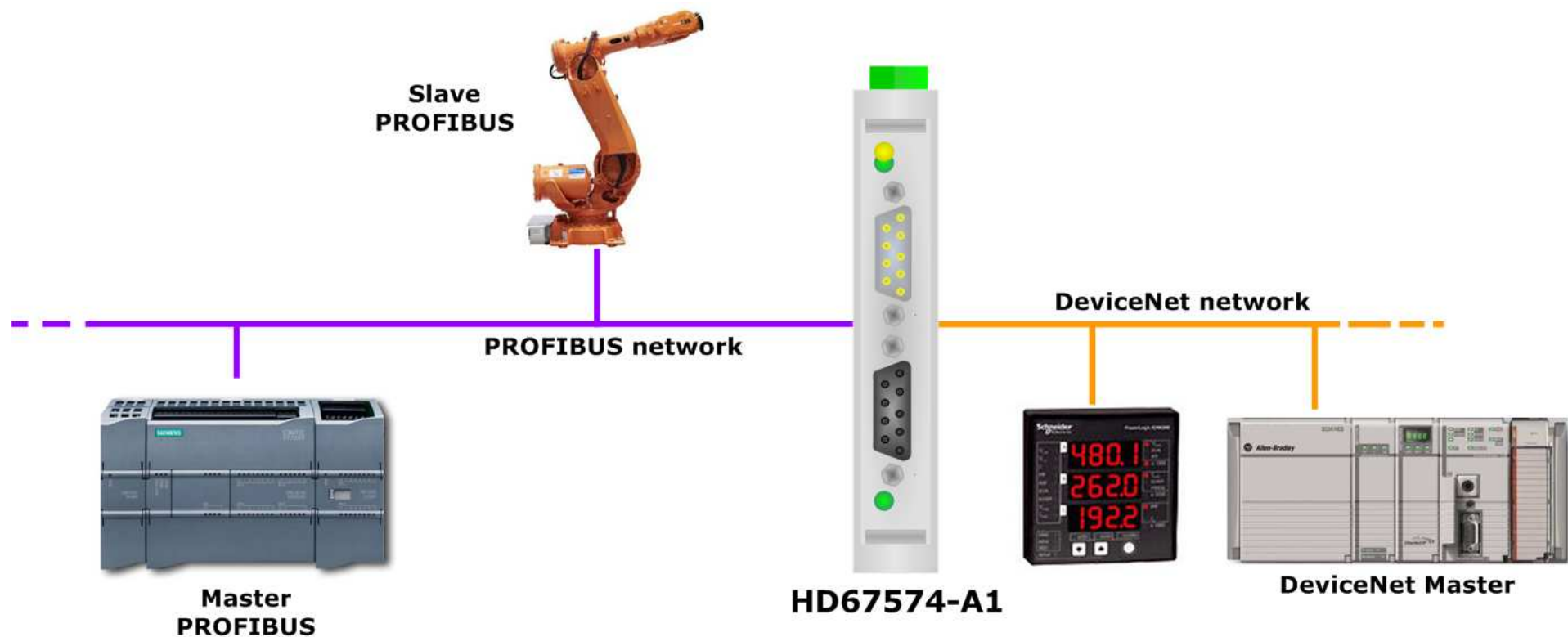

CONNECTION SCHEME:

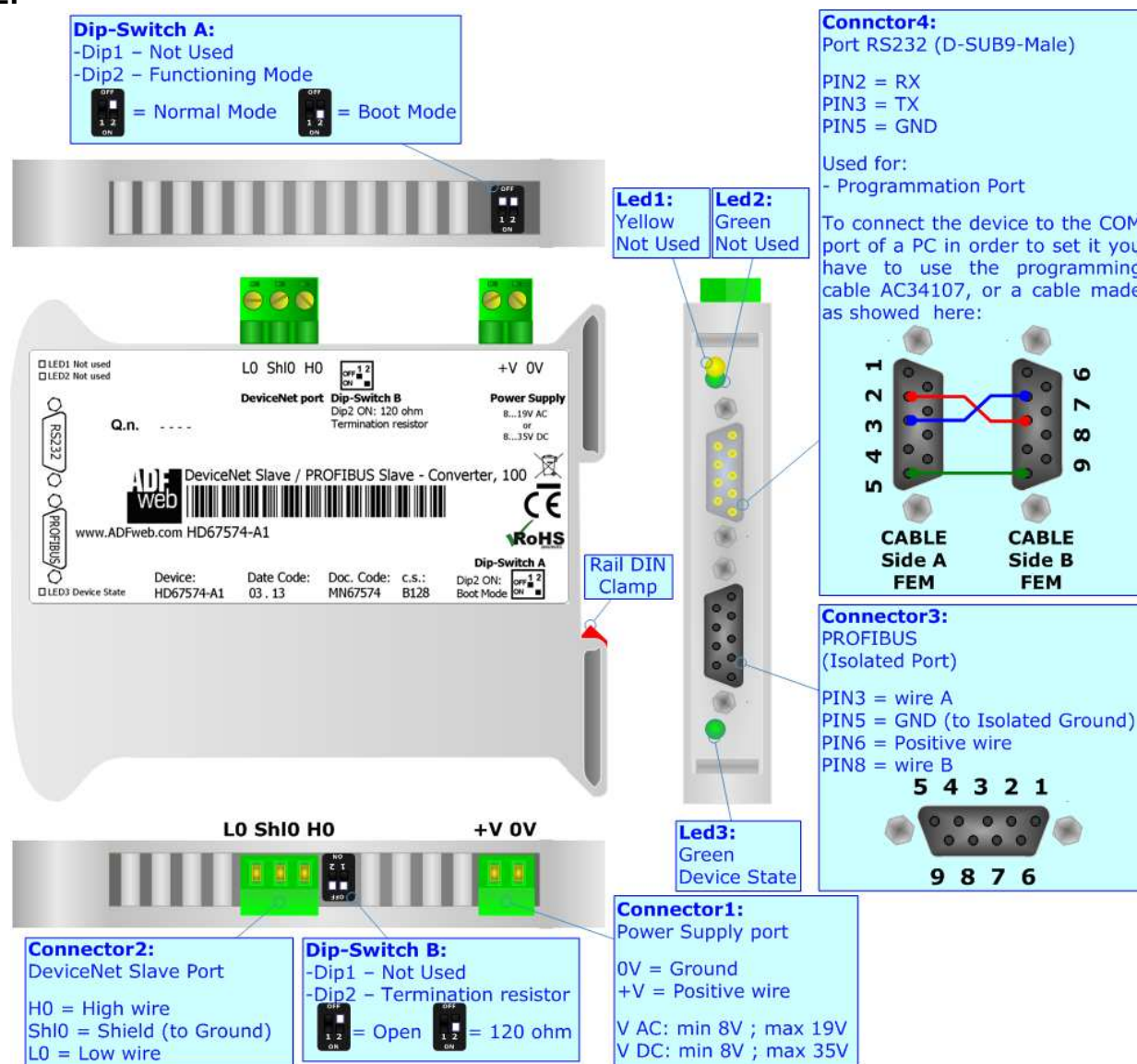

Figure 1: Connection scheme for HD67574-A1

CHARACTERISTICS:

The Configurable DeviceNet Slave / PROFIBUS Slave - Converter allows the following characteristics:

- Two-directional information between network DeviceNet and PROFIBUS;
- Electrical isolation between two buses;
- Up to 244 bytes in reading and 244 bytes in writing;
- Power Supply 8...19V AC or 12...35V DC;
- Mountable on 35mm Rail DIN;
- Temperature range -40°C to 85°C.

CONFIGURATION:

You need Compositor SW67574 software on your PC in order to perform the following:

- Define the parameter of the DeviceNet;
- Define the parameter of the PROFIBUS;
- Create a GSD File;
- Update the device.

POWER SUPPLY:

The devices can be powered at 8...19V AC and 8...35V DC. The consumption depends to the code of the device. For more details see the two tables below.

VAC		VDC	
Vmin	Vmax	Vmin	Vmax
8V	19V	8V	35V

Consumption at 24V DC:

Device	Consumption [W/VA]
HD67574-A1	3.5

Connector1:
 Power Supply port
 0V = Ground
 +V = Positive wire
 V AC: min 8V ; max 19V
 V DC: min 8V ; max 35V



Caution: Not reverse the polarity power

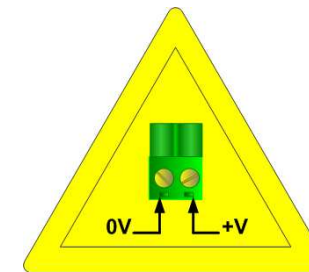

HD67574-A1

FUNCTION MODES:

The device has got two functions mode depending of the position of the 'Dip2 of Dip-Switch A':

- The first, with 'Dip2 of Dip-Switch A' at "OFF" position, is used for the normal working of the device.
- The second, with 'Dip2 of Dip-Switch A' at "ON" position, is used for upload the Project and/or Firmware.

For the operations to follow for the updating, see 'UPDATE DEVICE' section.

According to the functioning mode, the LEDs will have specifics functions, see 'LEDS' section.



LEDS:

The device has got three LEDs that are used to give information of the functioning status.
The various meanings of the LEDs are described in the table below.

LED	Normal Mode	Boot Mode
1: Not used (yellow)	Not used	Not used
2: Not used (green)	Not used	Not used
3: Device State (green)	Blinks slowly (~1Hz)	Blinks quickly: Boot state Blinks very slowly (~0.5Hz): update in progress



PROFIBUS:

The PROFIBUS uses a 9-pin D-SUB connector. The pin assignment is defined like in the right figure.

Here some codes of cables:

- ▶ Belden: p/n 183079A - Continuous Armor DataBus® ISA/SP-50 PROFIBUS Cable;

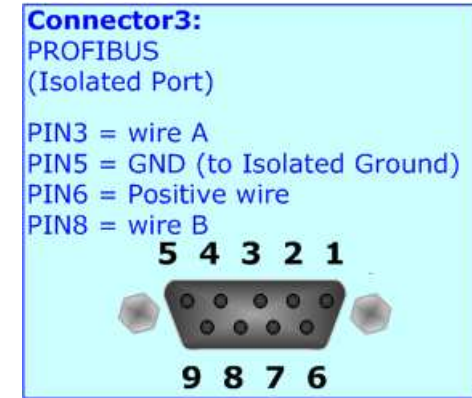

RS232:

The connection from RS232 socket to a serial port (example one from a personal computer), must be made with a Null Modem cable (a serial cable where the pins 2 and 3 are crossed). It is recommended that the RS232C Cable not exceed 15 meters.

The serial port is used for programming the device.

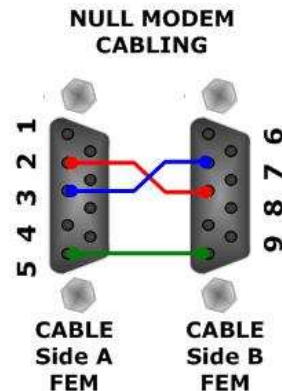

DEVICENET:

For terminate the DeviceNet line with a 120Ω resistor it is necessary that the Dip1 of 'Dip-Switch B' is at ON position.

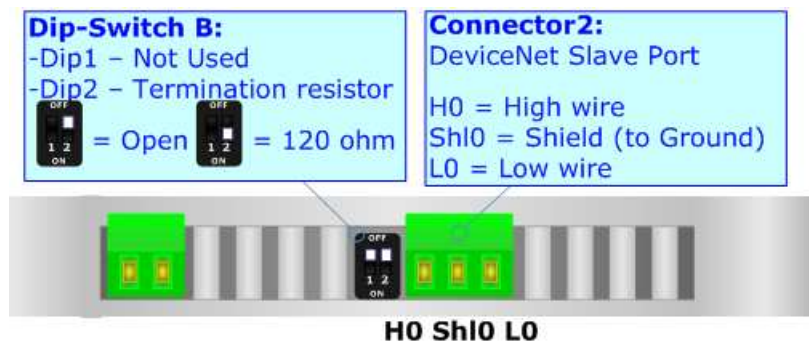

Cable characteristics:

DC parameter:	Impedance	70 Ohm/m
AC parameters:	Impedance	120 Ohm/m
	Delay	5 ns/m
Length	Baud Rate [bps]	Length MAX [m]
	125 K	500
	250 K	250
	500 K	100

USE OF COMPOSITOR SW67574:

To configure the Converter, use the available software that runs with Windows, called SW67574. It is downloadable on the site www.adfweb.com and its operation is described in this document. (This manual is referenced to the last version of the software present on our web site). The software works with MSWindows (MS 2000, XP, Vista, Seven, 8; 32/64bit).

When launching the SW67574 the right window appears (Fig. 2).

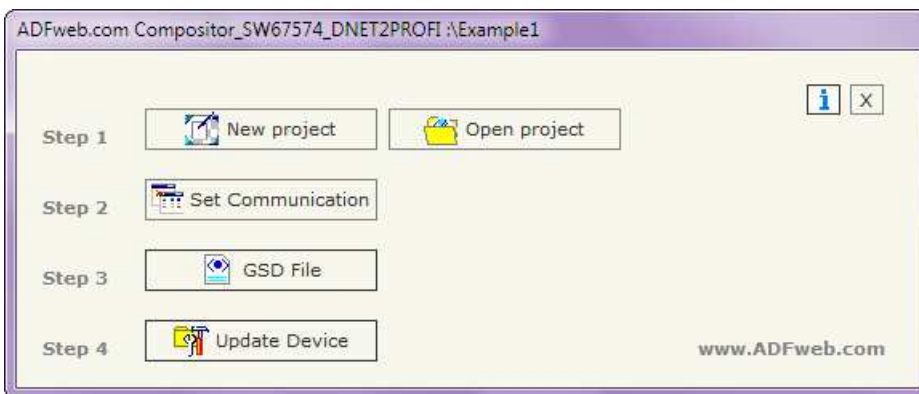

Figure 2: Main window for SW67574

NEW PROJECT / OPEN PROJECT:

The “**New Project**” button creates the folder which contains the entire device configuration.



A device configuration can also be imported or exported:

- To clone the configurations of a programmable “DeviceNet Slave / PROFIBUS Slave – Converter” in order to configure another device in the same manner, it is necessary to maintain the folder and all its contents;
- To clone a project in order to obtain a different version of the project, it is sufficient to duplicate the project folder with another name and open the new folder with the button “**Open Project**”.

SET COMMUNICATION:

This section defines the fundamental communication parameter of two Buses, PROFIBUS and DeviceNet.

By Pressing the "**Set Communication**" button from the main window for SW67574 (Fig. 2) the window "SET COMMUNICATION" appears (Fig. 3).

The window is divided in two sections, one for the PROFIBUS and the other for the DeviceNet.

The means of the fields for "PROFIBUS" are:

- In the field "**ID Dev.**" the address for the PROFIBUS side is defined;
- In the field "**N Byte IN**" the number of byte from the slave PROFIBUS to the gateway is defined (at maximum it is possible to use 244 byte);
- In the field "**N Byte OUT**" the number of byte from the gateway to the slave PROFIBUS is defined (at maximum it is possible to use 244 byte).

The means of the fields for "DeviceNet" are:

- In the field "**ID Dev.**" the address of the DeviceNet is defined;
- In the field "**Baud rate**" the velocity of the DeviceNet bus is defined.

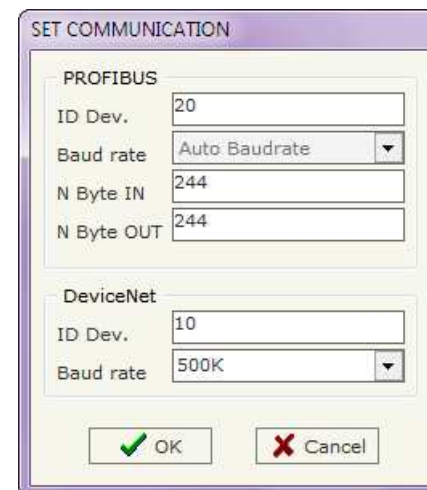

Figure 3: "Set Communication" window

GSD FILE:

By pressing the "**GSD File**" button it is possible to save the GSD file for the PROFIBUS side. With this feature you can save the configuration of the gateway of the PROFIBUS side.



Note:

When you import the .gsd file on your Master PROFIBUS you have to add all the modules that are present inside it.

UPDATE DEVICE:

By pressing the **Update Device** button it is possible to load the created Configuration into the device; and also the Firmware, if is necessary.

In order to load the parameters or update the firmware in the gateway, follow these instructions:

- Turn off the Device;
- Connect the Null Modem Cable form your PC to the Gateway;
- Put Dip2 of Dip-Switch A at "ON" position (see "FUNCTION MODES" section);
- Select the **COM port** and press the **Connect** button;
- Turn on the device;
- Check the BOOT Led. It must blink quickly (see "LEDS" section);
- Press the **Next** button;
- Select which operations you want to do.
- Press the **Execute update firmware** button to start the upload;
- When all the operations are "OK" turn off the device;
- Put Dip2 of Dip-Switch A at "OFF" position;
- Disconnect the RS232 Cable;
- Turn on the device.

At this point the configuration/firmware on the device is correctly update.

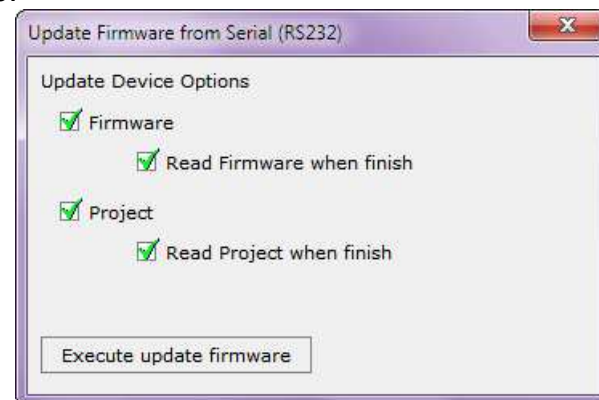
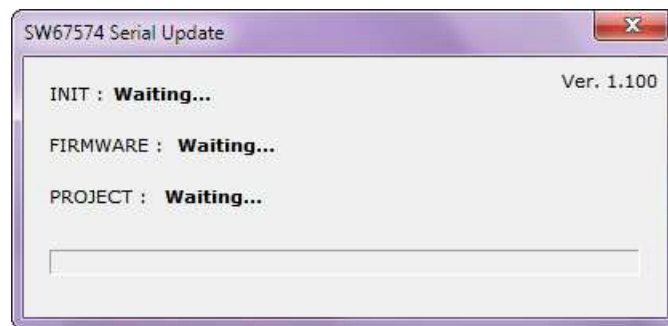

Figure 4: "Update Device" windows

**Note:**

When you install a new version of the software it is better if the first time you do the update of the Firmware in the HD67574-A1 device.

**Note:**

When you receive the device, for the first time, you have to update also the Firmware in the HD67597-A1 device.

**Warning:**

If the Fig. 5 appears when you try to do the Update before require assistance try these points:

- Check if the serial COM port selected is the correct one;
- Check if the serial is connected between the PC and the device;
- Try to repeat the operations for the updating;
- If you are using a dongle try with a native COM port or change the dongle;
- Try with another PC;
- Try to restart the PC;
- If you are using the program inside a Virtual Machine, try to use in the main Operating System;
- If you are using Windows Seven or Vista or 8, make sure that you have the administrator privileges;
- Take attention at Firewall lock.

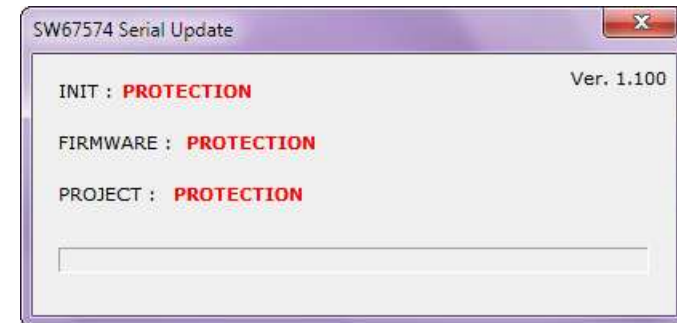
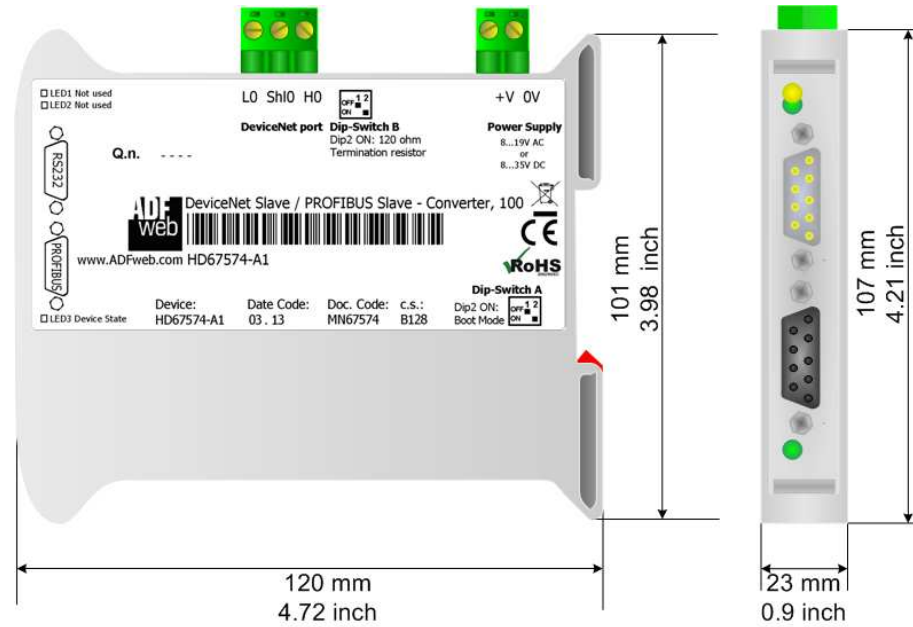

Figure 5: "Protection" window

MECHANICAL DIMENSIONS:



Housing: PVC
Weight: 200g (Approx)

Figure 7: Mechanical dimensions scheme

ORDER CODE:

Order Code: **HD67574-A1** - DeviceNet Slave / PROFIBUS Slave - Converter

ACCESSORIES:

- Order Code: **AC34107** - Null Modem Cable Fem/Fem DSub 9 Pin 1,5 m
- Order Code: **AC34114** - Null Modem Cable Fem/Fem DSub 9 Pin 5 m
- Order Code: **AC34001** - Rail DIN - Power Supply 220/240V AC 50/60Hz – 12 V AC
- Order Code: **AC34002** - Rail DIN - Power Supply 110V AC 50/60Hz – 12 V AC

DISCLAIMER

All technical content within this document can be modified without notice. The content of the document content is a recurring audit. For losses due to fire, earthquake, third party access or other accidents, or intentional or accidental abuse, misuse, or use under abnormal conditions repairs are charged to the user. ADFweb.com S.r.l. will not be liable for accidental loss of use or inability to use this product, such as loss of business income. ADFweb.com S.r.l. shall not be liable for consequences of improper use.

OTHER REGULATIONS AND STANDARDS

WEEE INFORMATION



Disposal of old electrical and electronic equipment (as in the European Union and other European countries with separate collection systems).



This symbol on the product or on its packaging indicates that this product may not be treated as household rubbish. Instead, it should be taken to an applicable collection point for the recycling of electrical and electronic equipment. If the product is disposed correctly, you will help prevent potential negative environmental factors and human health, which could otherwise be caused by inappropriate disposal. The recycling of materials will help to conserve natural resources. For more information about recycling this product, please contact your local city office, your household waste disposal service or the shop where you purchased the product.

RESTRICTION OF HAZARDOUS SUBSTANCES DIRECTIVE



The device respects the 2002/95/EC Directive on the restriction of the use of certain hazardous substances in electrical and electronic equipment (commonly referred to as Restriction of Hazardous Substances Directive or RoHS).

CE MARKING



The product conforms with the essential requirements of the applicable EC directives.

WARRANTIES AND TECHNICAL SUPPORT:

For fast and easy technical support for your ADFweb.com SRL products, consult our internet support at www.adfweb.com. Otherwise contact us at the address support@adfweb.com

RETURN POLICY:

If while using your product you have any problem and you wish to exchange or repair it, please do the following:

- 1) Obtain a Product Return Number (PRN) from our internet support at www.adfweb.com. Together with the request, you need to provide detailed information about the problem.
- 2) Send the product to the address provided with the PRN, having prepaid the shipping costs (shipment costs billed to us will not be accepted).

If the product is within the warranty of twelve months, it will be repaired or exchanged and returned within three weeks. If the product is no longer under warranty, you will receive a repair estimate.

PRODUCTS AND RELATED DOCUMENTS:

Part	Description	URL
HD67121	Gateway CANopen / Canopen	www.adfweb.com?product=HD67121
HD67502	Gateway CANopen / Modbus - RTU	www.adfweb.com?product=HD67502
HD67505	Gateway CANopen / Modbus - Ethernet TCP	www.adfweb.com?product=HD67505
HD67134	Gateway CANopen / DeviceNet	www.adfweb.com?product=HD67134
HD67117	CAN bus Repeater	www.adfweb.com?product=HD67117
HD67216	CAN bus Analyzer	www.adfweb.com?product=HD67216