

User Manual

Revision 1.000

English

EtherCAT / DMX - Converter

(Order Code: HD67E11-A1)

For Website information:

www.adfweb.com?Product=HD67E11

For Price information:

www.adfweb.com?Price=HD67E11-A1

Benefits and Main Features:

- ⊕ Very easy to configure
- ⊕ Triple Electrical isolation
- ⊕ Temperature range: -40°C/+85°C (-40°F/+185°F)



For other EtherCAT Slave products see also the following link:

Converter EtherCAT Slave to

www.adfweb.com?Product=HD67E00
www.adfweb.com?Product=HD67E01
www.adfweb.com?Product=HD67E02
www.adfweb.com?Product=HD67E03
www.adfweb.com?Product=HD67E04
www.adfweb.com?Product=HD67E05
www.adfweb.com?Product=HD67E06
www.adfweb.com?Product=HD67E07
www.adfweb.com?Product=HD67E08
www.adfweb.com?Product=HD67E09
www.adfweb.com?Product=HD67E10
www.adfweb.com?Product=HD67E12
www.adfweb.com?Product=HD67E14
www.adfweb.com?Product=HD67E15
www.adfweb.com?Product=HD67E16
www.adfweb.com?Product=HD67E17
www.adfweb.com?Product=HD67E18
www.adfweb.com?Product=HD67E19
www.adfweb.com?Product=HD67E20
www.adfweb.com?Product=HD67E21
www.adfweb.com?Product=HD67E22
www.adfweb.com?Product=HD67E23
www.adfweb.com?Product=HD67E24
www.adfweb.com?Product=HD67E25
www.adfweb.com?Product=HD67E26
www.adfweb.com?Product=HD67E27
www.adfweb.com?Product=HD67E28
www.adfweb.com?Product=HD67879

(Serial)
(Modbus Master)
(Modbus Slave)
(Modbus TCP Master)
(DMX TCP Slave)
(BACnet Master)
(BACnet Slave)
(CAN)
(CANopen)
(DeviceNet Master)
(DeviceNet Slave)
(Ethernet)
(IEC61850 Client)
(IEC61850 Server)
(J1939)
(MQTT)
(NMEA0183)
(NMEA2000)
(OPC UA Client)
(OPC UA Server)
(PROFINET Master)
(PROFINET Slave)
(SNMP Manager)
(SNMP Agent)
(EtherNet/IP Master)
(EtherNet/IP Slave)
(S7comm Client)
(IO-Link Master)



User Manual

INDEX:

| | |
|--|------|
| | Page |
| INDEX | 2 |
| UPDATED DOCUMENTATION | 2 |
| REVISION LIST | 2 |
| WARNING | 2 |
| TRADEMARKS | 2 |
| SECURITY ALERT | 3 |
| EXAMPLE OF CONNECTION | 4 |
| CONNECTION SCHEME | 5 |
| CHARACTERISTICS | 6 |
| CONFIGURATION | 6 |
| POWER SUPPLY | 7 |
| FUNCTION MODES | 8 |
| LEDS | 9 |
| ETHERCAT | 10 |
| RS485 | 11 |
| ETHERNET | 12 |
| USE OF COMPOSITOR SW67E11 | 13 |
| NEW CONFIGURATION / OPEN CONFIGURATION | 14 |
| SOFTWARE OPTIONS | 15 |
| SET COMMUNICATION | 17 |
| ETHERCAT SET ACCESS | 18 |
| DMX DEFAULT VALUE | 20 |
| ETHERCAT ESI FILE | 21 |
| UPDATE DEVICE | 22 |
| MECHANICAL DIMENSIONS | 24 |
| ORDERING INFORMATIONS | 25 |
| ACCESSORIES | 25 |
| DISCLAIMER | 26 |
| OTHER REGULATIONS AND STANDARDS | 26 |
| WARRANTIES AND TECHNICAL SUPPORT | 27 |
| RETURN POLICY | 27 |

UPDATED DOCUMENTATION:

Dear customer, we thank you for your attention and we remind you that you need to check that the following document is:

- ✚ Updated
- ✚ Related to the product you own

To obtain the most recently updated document, note the “document code” that appears at the top right-hand corner of each page of this document.

With this “Document Code” go to web page www.adfweb.com/download/ and search for the corresponding code on the page. Click on the proper “Document Code” and download the updates.

REVISION LIST:

| Revision | Date | Author | Chapter | Description |
|----------|------------|--------|---------|---------------|
| 1.000 | 18/09/2020 | Ff | All | First Release |
| | | | | |
| | | | | |

WARNING:

ADFweb.com reserves the right to change information in this manual about our product without warning.
ADFweb.com is not responsible for any error this manual may contain.

TRADEMARKS:

All trademarks mentioned in this document belong to their respective owners.

SECURITY ALERT:**GENERAL INFORMATION**

To ensure safe operation, the device must be operated according to the instructions in the manual. When using the device, legal and safety regulation are required for each individual application. The same applies also when using accessories.

INTENDED USE

Machines and systems must be designed so the faulty conditions do not lead to a dangerous situation for the operator (i.e. independent limit switches, mechanical interlocks, etc.).

QUALIFIED PERSONNEL

The device can be used only by qualified personnel, strictly in accordance with the specifications. Qualified personnel are persons who are familiar with the installation, assembly, commissioning and operation of this equipment and who have appropriate qualifications for their job.

RESIDUAL RISKS

The device is state-of-the-art and is safe. The instruments can represent a potential hazard if they are inappropriately installed and operated by untrained personnel. These instructions refer to residual risks with the following symbol:



This symbol indicates that non-observance of the safety instructions is a danger for people that could lead to serious injury or death and / or the possibility of damage.

CE CONFORMITY

The declaration is made by our company. You can send an email to support@adfweb.com or give us a call if you need it.

EXAMPLE OF CONNECTION:

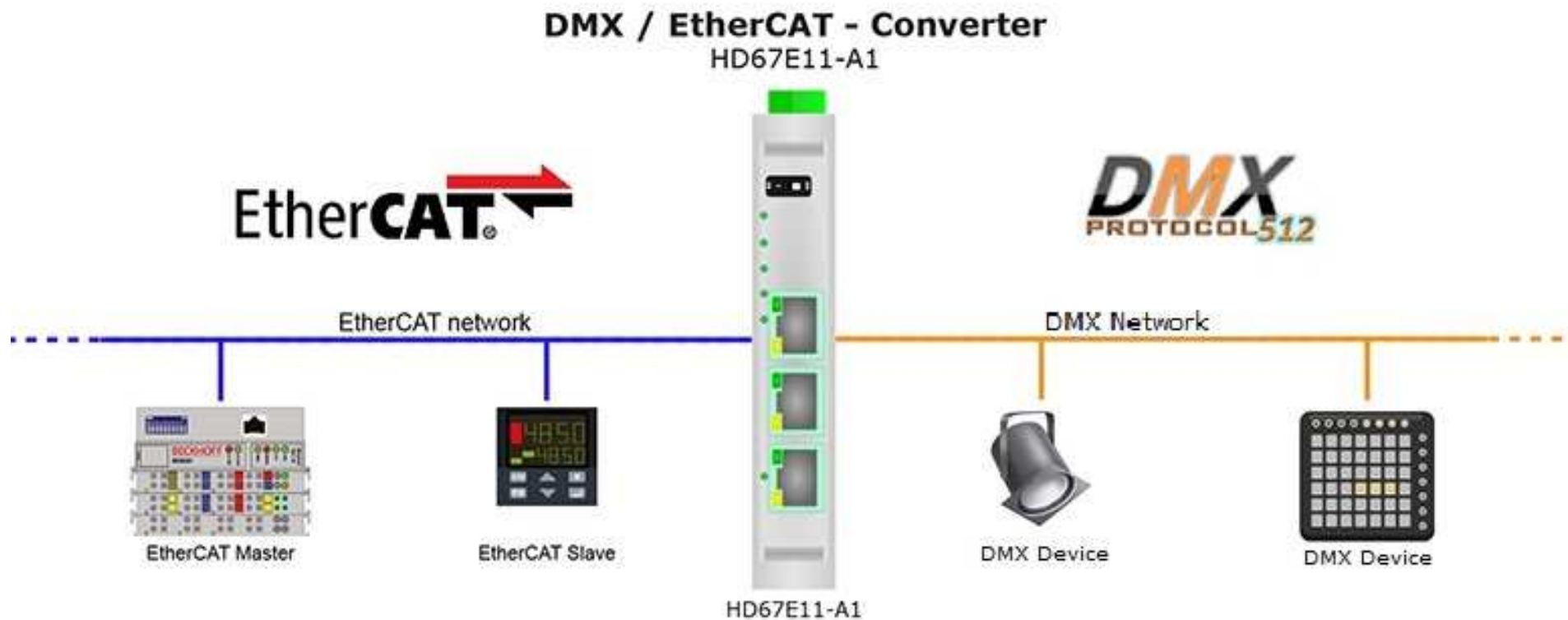

ADFweb.com



+39 0438 309 131



+39 349 440 9592



support@adfweb.com

CONNECTION SCHEME

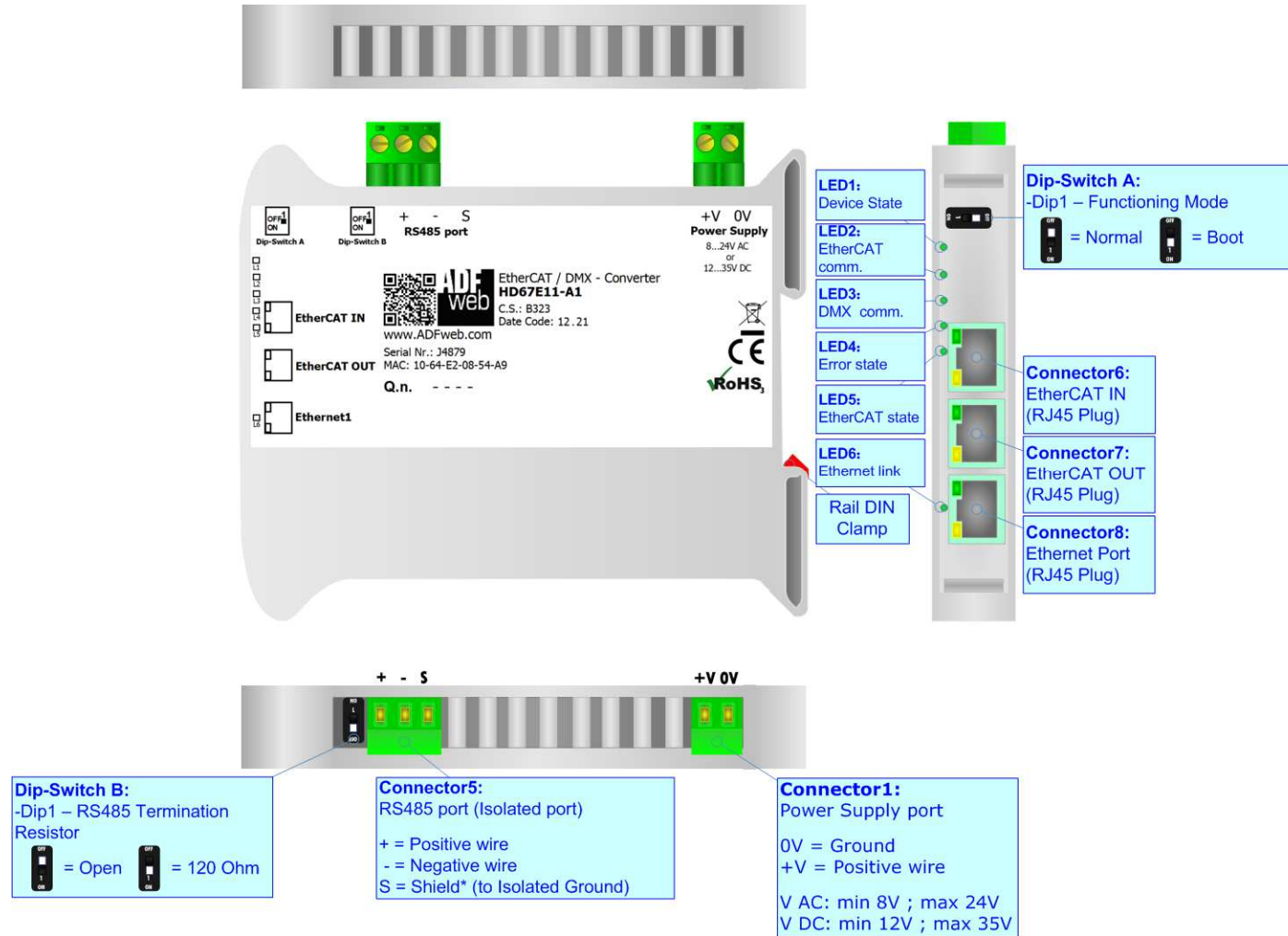

Figure 1b: Connection scheme for HD67E11-A1

CHARACTERISTICS:

The HD67E11-A1 are EtherCAT / DMX - Converters.

It allows for the following characteristics:

- Isolation between EtherCAT – DMX – Power Supply;
- Two-directional information between EtherCAT bus and DMX bus;
- Mountable on 35mm Rail DIN;
- Wide power supply input range: 8...24V AC or 12...35V DC;
- Wide temperature range: -40°C / 85°C [-40°F / +185°F].

CONFIGURATION:

You need Compositor SW67E11 software on your PC in order to perform the following:

- Define the parameters of EtherCAT line;
- Define the parameters of DMX line;
- Define EtherCAT variables to read and write;
- Export the ESI file for configuration of EtherCAT Master;
- Update the device.

POWER SUPPLY:

The devices can be powered at 8...24V AC and 12...35V DC. For more details see the two tables below.

| VAC | | VDC | |
|------|------|------|------|
| Vmin | Vmax | Vmin | Vmax |
| 8V | 24V | 12V | 35V |

Consumption at 24V DC:

| Device | Consumption [W/VA] |
|------------|--------------------|
| HD67E11-A1 | 3.5 |

Connector1:
Power Supply port
0V = Ground
+V = Positive wire
V AC: min 8V ; max 24V
V DC: min 12V ; max 35V

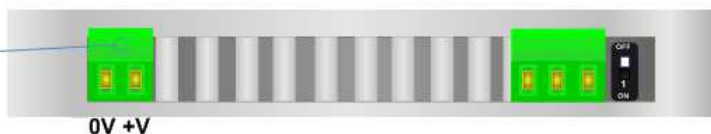

Caution: Do not reverse the polarity power

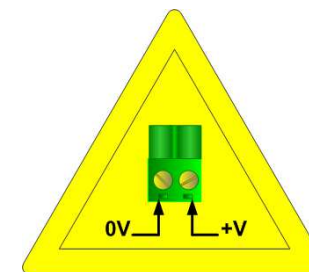

HD67E11-A1

FUNCTION MODES:

The device has got two function modes depending on the position of the 'Dip1 of Dip-Switch A':

- The first, with 'Dip1 of Dip-Switch A' at "OFF" position, is used for the normal working of the device.
- The second, with 'Dip1 of Dip-Switch A' at "ON" position, is used for uploading the Project and/or Firmware.

For the operations to follow for the updating, see 'UPDATE DEVICE' section.

According to the functioning mode, the LEDs will have specific functions, see 'LEDS' section.

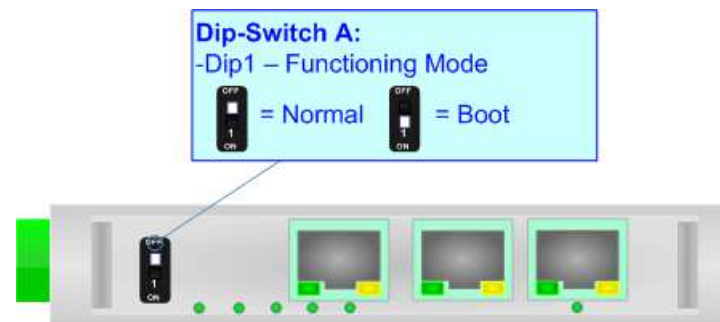

LEDS:

The device has got seven LEDs that are used to give information about the functioning status.
The various meanings of the LEDs are described in the table below.

| LED | Normal Mode | Boot Mode |
|---------------------------|--|---|
| 1: Device State (green) | Blinks slowly (~1Hz) | Blinks quickly: Boot state Blinks very slowly (~0.5Hz): update in progress |
| 2: EtherCAT comm. (green) | It blinks when EtherCAT communication is running | Blinks quickly: Boot state Blinks very slowly (~0.5Hz): update in progress |
| 3: DMX comm. (green) | It blinks when a DMX message is received | Blinks quickly: Boot state Blinks very slowly (~0.5Hz): update in progress |
| 4: Error state (green) | ON: An error in the communication busses occurs OFF: No errors are present | Blinks quickly: Boot state Blinks very slowly (~0.5Hz): update in progress |
| 5: EtherCAT state (green) | OFF: EtherCAT Master not connected Blinking: EtherCAT Master is connecting ON: EtherCAT Master is connected | Blinks quickly: Boot state Blinks very slowly (~0.5Hz): update in progress |
| 6: Ethernet1 link (green) | ON: Ethernet cable connected OFF: Ethernet cable disconnected | ON: Ethernet cable connected OFF: Ethernet cable disconnected |

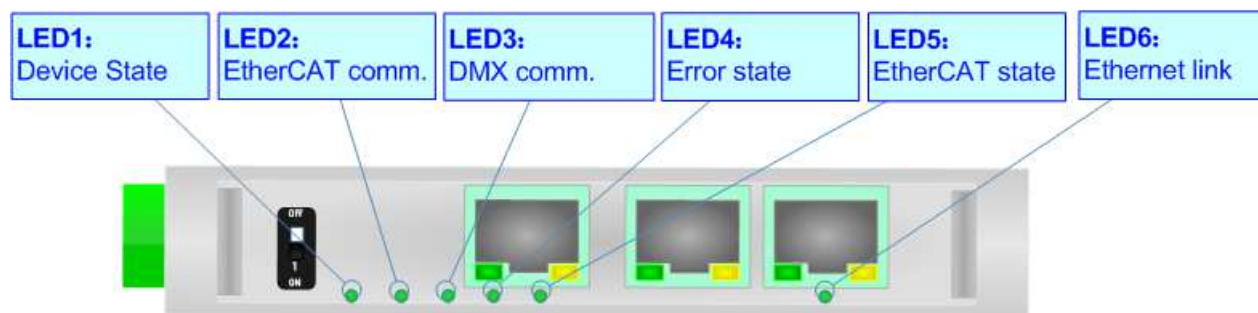

ETHERCAT

EtherCAT (Ethernet for Control Automation Technology) is an Ethernet-based fieldbus system, invented by Beckhoff Automation.

The protocol is standardized in IEC 61158 and is suitable for both hard and soft real-time computing requirements in automation technology. With EtherCAT, the standard Ethernet packet or frame (according to IEEE 802.3) is no longer received, interpreted, and copied as process data at every node. The EtherCAT slave devices read the data addressed to them while the telegram passes through the device, processing data "on the fly". In other words, real-time data and messages are prioritized over more general, less time-sensitive or heavy load data.

The converter has two EtherCAT ports, one is used as Input port (Connector6) and it will receive the incoming messages from the Master, the other is used as Output port (Connector7) and it will forward the messages to the others nodes of the network.

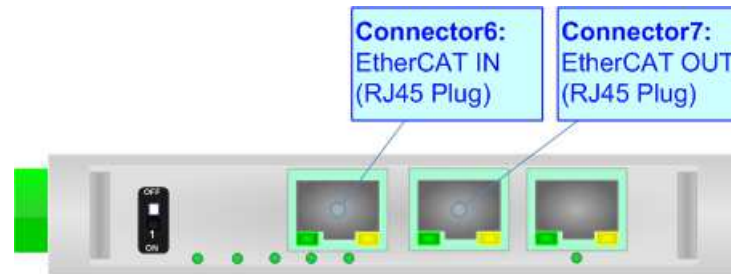

RS485:

For terminate the RS485 line with a 120Ω resistor it is necessary to put ON dip 1, like in figure.

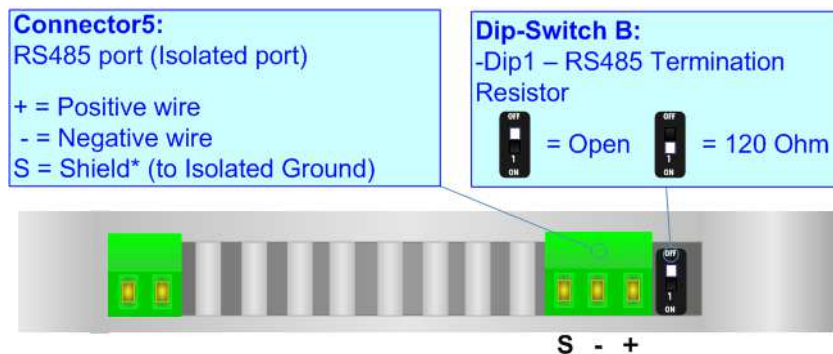

The maximum length of the cable should be 1200m (4000 feet).

Here some codes of cables:

- Belden: p/n 8132 - 2x 28AWG stranded twisted pairs conductor + foil shield + braid shield;
- Belden p/n 82842 - 2x 24AWG stranded twisted pairs conductor + foil shield + braid shield;
- Tasker: p/n C521 - 1x 24AWG twisted pair conductor + foil shield + braid shield;
- Tasker: p/n C522 - 2x 24AWG twisted pairs conductor + foil shield + braid shield.

ETHERNET:

The updating of the converter must be made using Connector8 of the HD67E11-A1 with at least a Category 5E cable. The maximum length of the cable should not exceed 100m. The cable has to conform to the T568 norms relative to connections in cat.5 up to 100 Mbps. To connect the device to an Hub/Switch is recommended the use of a straight cable, to connect the device to a PC/PLC/other is recommended the use of a cross cable.

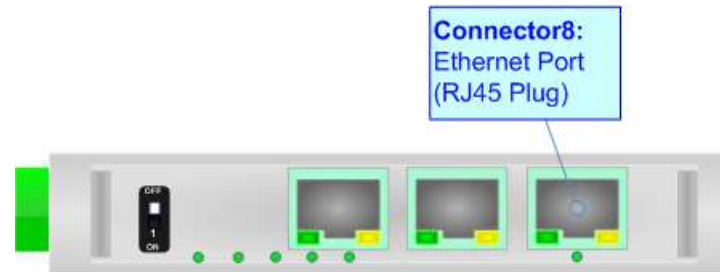

USE OF COMPOSITOR SW67E11:

To configure the Converter, use the available software that runs with Windows called SW67E11. It is downloadable on the site www.adfweb.com and its operation is described in this document. *(This manual is referenced to the last version of the software present on our web site).* The software works with MSWindows (XP, Vista, Seven, 8, 10; 32/64bit).

When launching the SW67E11, the window below appears (Fig. 2).

 **Note:**
It is necessary to have installed .Net Framework 4.



Figure 2: Main window for SW67E11

NEW CONFIGURATION / OPEN CONFIGURATION:

The “**New Configuration**” button creates the folder which contains the entire device’s configuration.



A device’s configuration can also be imported or exported:

- To clone the configurations of a programmable “EtherCAT Slave / DMX - Converter” in order to configure another device in the same manner, it is necessary to maintain the folder and all its contents;
- To clone a project in order to obtain a different version of the project, it is sufficient to duplicate the project folder with another name and open the new folder with the button “**Open Configuration**”.



SOFTWARE OPTIONS:

By pressing the “**Settings**” () button there is the possibility to change the language of the software and check the updatings for the compositor.

In the section “Language” it is possible to change the language of the software.



In the section “Connection Options”, it is possible to check if there are some updatings of the software compositor in ADFweb.com website. Checking the option “**Check Software Update at Start of Program**”, the SW67E11 checks automatically if there are updatings when it is launched.



In the section "Software Settings", it is possible to enable/disable some keyboard's commands for an easier navigation inside the tables contained in the different sections of the software.

SET COMMUNICATION:

This section define the fundamental communication parameters of two buses, EtherCAT and DMX.

By Pressing the **"Set Communication"** button from the main window for SW67E11 (Fig. 2) the window "Set Communication" appears (Fig. 3).

The means of the fields for "EtherCAT Slave" are:

- In the field **"Revision Number"** the revision number of the converter is defined;
- In the field **"Slave Name"** the name of the converter is defined;
- In the field **"Node Address"** the ID of the converter is defined.

The means of the fields for "DMX" section are:

- In the field **"DMX"** it is possible to define if the converter will act as DMX controller ("OUT") or as DMX device ("IN");
- In the field **"Channel Number"** the number of channels of the DMX side is defined (up to 512 channels).

The means of the fields for "Ethernet" are:

- In the fields **"IP Address"** the IP address for Ethernet side of the converter is defined;
- In the fields **"SubNet Mask"** the SubNet Mask for Ethernet side of the converter is defined;
- In the fields **"Gateway"** the default gateway of the net is defined. This feature can be enabled or disabled pressing the Check Box field. This feature is used for going out of the net;
- In the fields **"DNS"** the IP address of the DNS server is defined

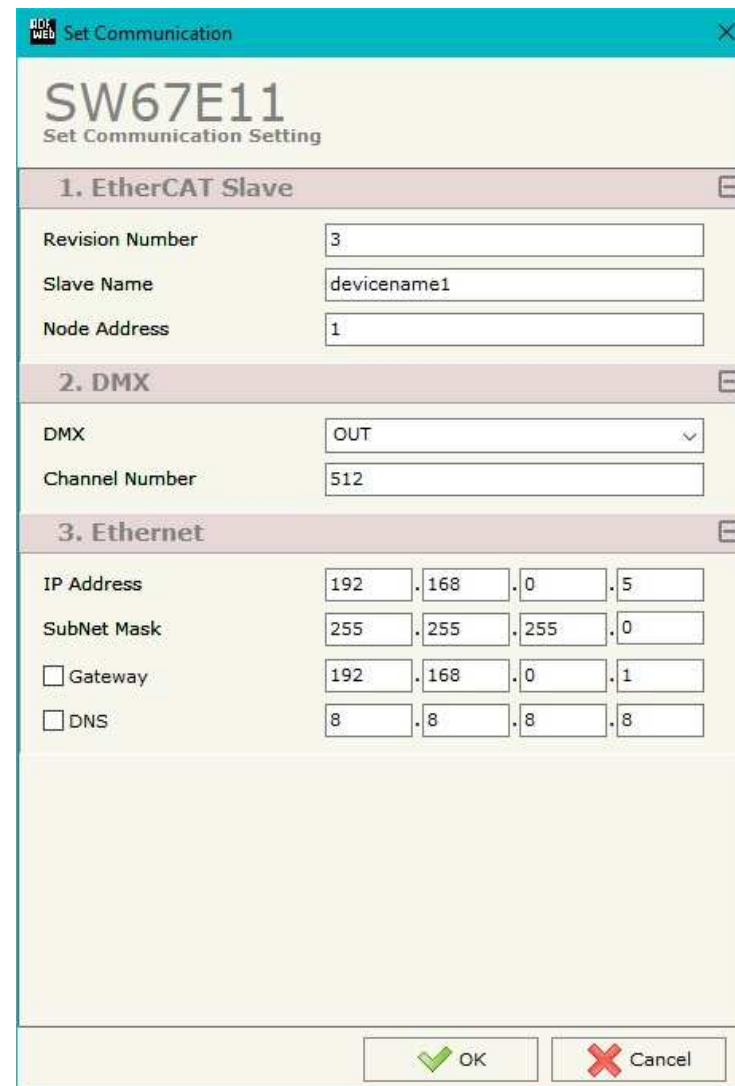

| 1. EtherCAT Slave | |
|-------------------|-------------|
| Revision Number | 3 |
| Slave Name | devicename1 |
| Node Address | 1 |

| 2. DMX | |
|----------------|-----|
| DMX | OUT |
| Channel Number | 512 |

| 3. Ethernet | |
|----------------------------------|---------------------|
| IP Address | 192 . 168 . 0 . 5 |
| SubNet Mask | 255 . 255 . 255 . 0 |
| <input type="checkbox"/> Gateway | 192 . 168 . 0 . 1 |
| <input type="checkbox"/> DNS | 8 . 8 . 8 . 8 |

Figure 3: "Set Communication" window

ETHERCAT SET ACCESS:

By Pressing the “**EtherCAT Set Access**” button from the main window for SW67E11 (Fig. 2) the window “EtherCAT Slave Set Access” appears (Fig. 4).

This section is used to define the EtherCAT variables readable by the EtherCAT Master (Slave To Master) and the EtherCAT variables writeable by the EtherCAT Master (Master To Slave).

SLAVE TO MASTER

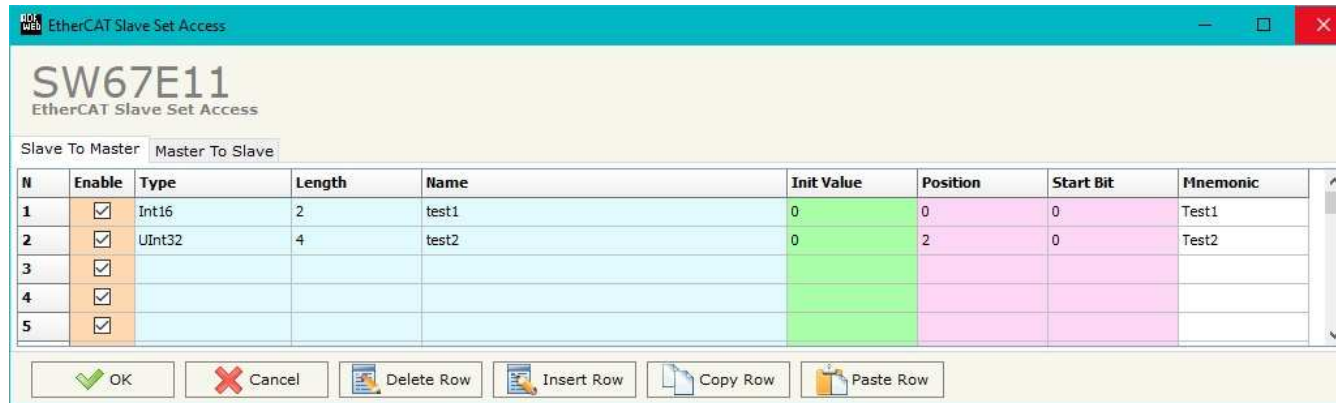

Figure 4a: "EtherCAT Slave Set Access → Slave To Master" window

The means of the fields are:

- If the field “**Enable**” is checked, the EtherCAT variable is enabled;
- In the field “**Type**” the data format of the EtherCAT variable is defined;
- In the field “**Length**” the dimension of the EtherCAT variable is defined;
- In the field “**Name**” the name of the EtherCAT variable is defined;
- In the field “**Init Value**” the default value of the EtherCAT variable is defined;
- In the field “**Position**” the starting address of the EtherCAT array where the variable is mapped is defined;
- In the field “**Start Bit**” the starting bit of the selected Position where the variable is mapped is defined;
- In the field “**Mnemonic**” a description of the variable is defined.

MASTER TO SLAVE



Figure 4b: "EtherCAT Slave Set Access → Master To Slave" window

The means of the fields are:

- If the field "**Enable**" is checked, the EtherCAT variable is enabled;
- In the field "**Type**" the data format of the EtherCAT variable is defined;
- In the field "**Length**" the dimension of the EtherCAT variable is defined;
- In the field "**Name**" the name of the EtherCAT variable is defined;
- In the field "**Position**" the starting address of the EtherCAT array where the variable is mapped is defined;
- In the field "**Start Bit**" the starting bit of the selected Position where the variable is mapped is defined;
- In the field "**Mnemonic**" a description of the variable is defined.

DMX DEFAULT VALUE:

By pressing the **DMX Default Value** button from the main window for SW67E11 (Fig. 2) the "DMX Default Value" window appears (Fig. 5). In this section it is possible to define the default value for each channel of the DMX array when the converter is turned ON.

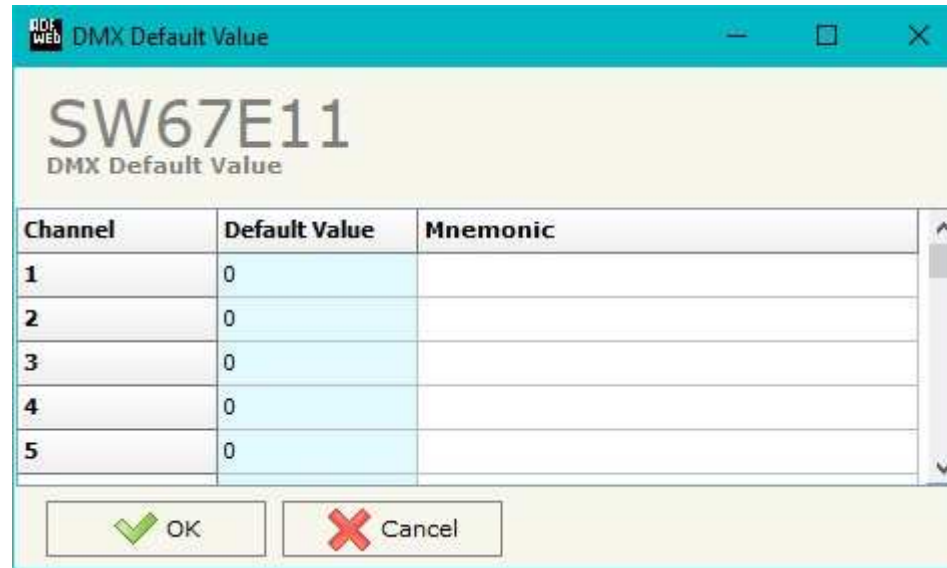

Figure 5: "DMX Default Value" window

ETHERCAT ESI FILE:

By pressing the "**EtherCAT ESI File**" button it is possible to save the ESI file for the EtherCAT side of the converter.
The ESI file is used to configure the EtherCAT Master.

UPDATE DEVICE:

By pressing the **“Update Device”** button, it is possible to load the created Configuration into the device; and also the Firmware, if necessary. This by using the Ethernet port.

If you don't know the actual IP address of the device you have to use this procedure:

- Turn OFF the Device;
- Put Dip1 of 'Dip-Switch A' in ON position;
- Turn ON the device
- Connect the Ethernet cable;
- Insert the IP **“192.168.2.205”**;
- Select which operations you want to do;
- Press the **“Execute update firmware”** button to start the upload;
- When all the operations are “OK” turn OFF the Device;
- Put Dip1 of 'Dip-Switch A' in OFF position;
- Turn ON the device.

If you know the actual IP address of the device, you have to use this procedure:

- Turn ON the Device with the Ethernet cable inserted;
- Insert the actual IP of the Converter;
- Select which operations you want to do;
- Press the **“Execute update firmware”** button to start the upload;
- When all the operations are “OK” the device automatically goes at Normal Mode.

At this point the configuration/firmware on the device is correctly updated.

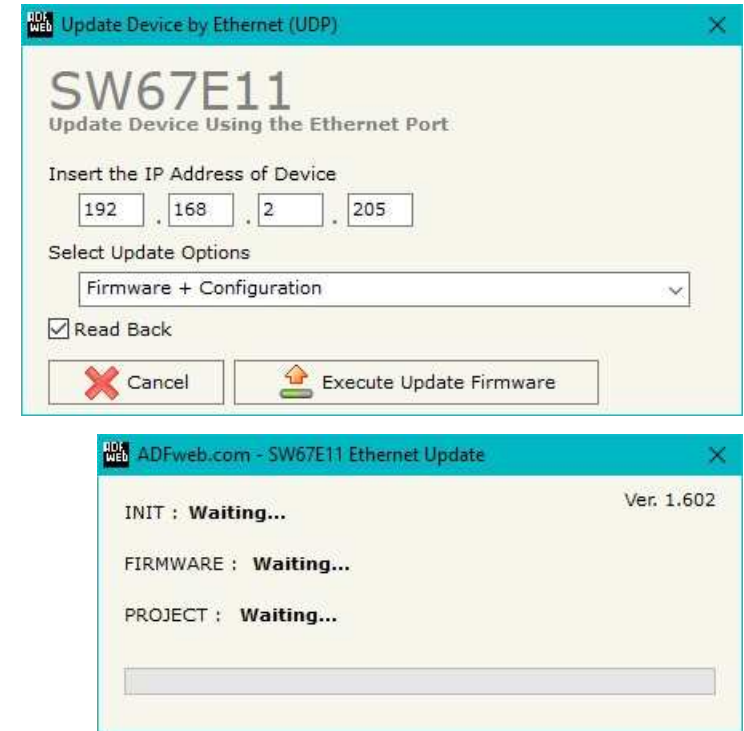

Figure 6: “Update device” windows

**Note:**

When you receive the device, for the first time, you also have to update the Firmware in the HD67E11 device.

**Warning:**

If Fig. 7 appears when you try to do the Update try these points before seeking assistance:

- Try to repeat the operations for the updating;
- Try with another PC;
- Try to restart the PC;
- Check the LAN settings;
- If you are using the program inside a Virtual Machine, try to use in the main Operating System;
- If you are using Windows Seven, Vista, 8 or 10 make sure that you have the administrator privileges;
- In case you have to program more than one device, using the "UDP Update", you have to cancel the ARP table every time you connect a new device on Ethernet. For do this you have to launch the "Command Prompt" and write the command "arp -d". Pay attention that with Windows Vista, Seven, 8, 10 you have to launch the "Command Prompt" with Administrator Rights;
- Pay attention at Firewall lock.

**Warning:**

In the case of HD67E11 you have to use the software "HD67E11": www.adfweb.com/download/filefold/SW67E11.zip.



Figure 7: "Error" window

MECHANICAL DIMENSIONS:

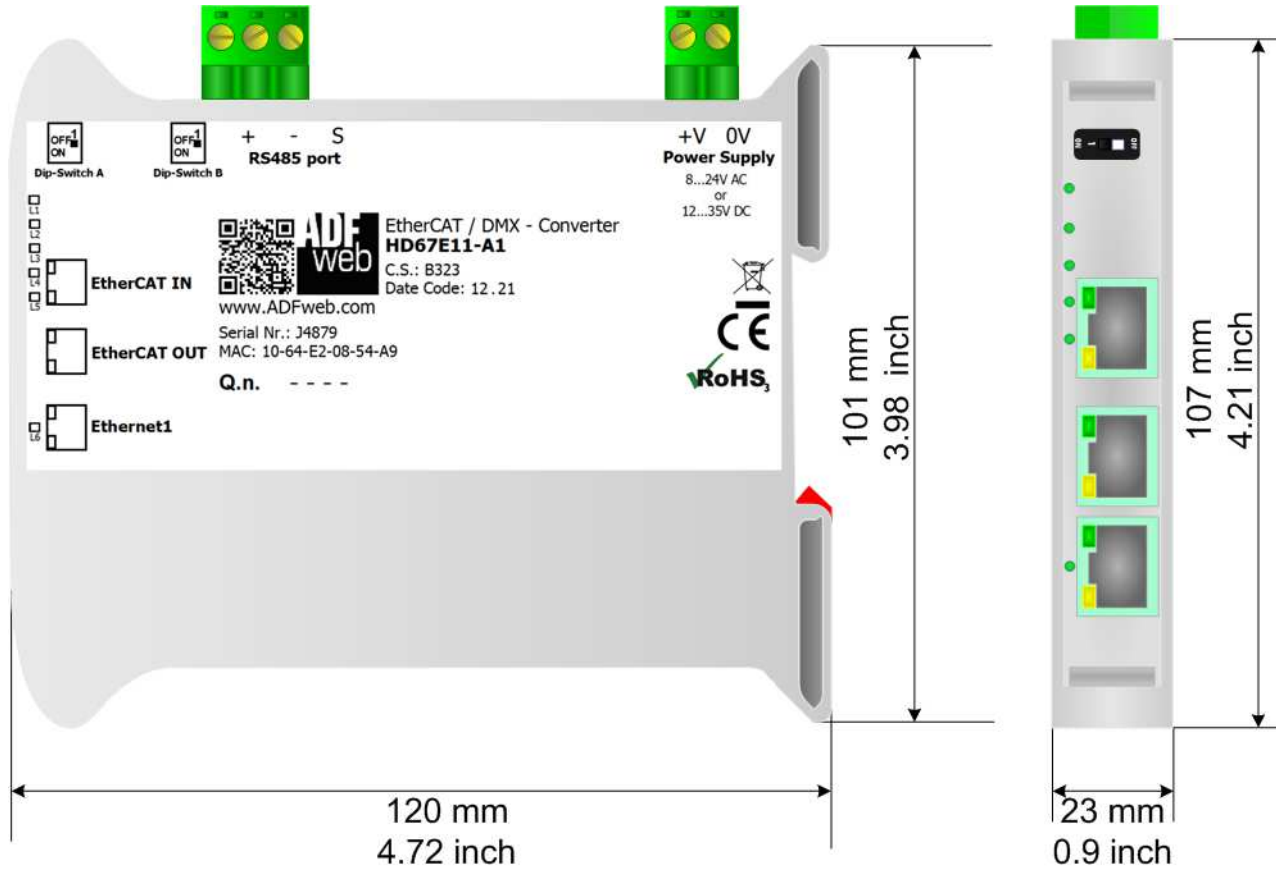

Housing: PVC
Weight: 200g (Approx)

Figure 8: Mechanical dimensions scheme for HD67E11-A1

ORDERING INFORMATIONS:

The ordering part number is formed by a valid combination of the following:

HD67E11 - xx

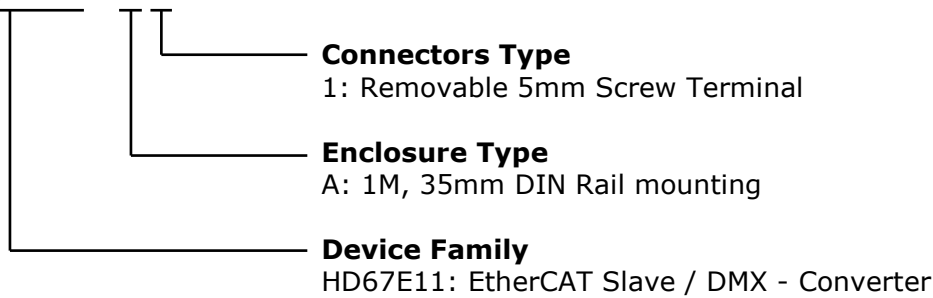

Order Code: **HD67E11-A1** - EtherCAT Slave / DMX - Converter (RS232)

ACCESSORIES:

Order Code: **AC34011** - 35mm Rail DIN - Power Supply 220/240V AC 50/60Hz - 12 V DC

Order Code: **AC34012** - 35mm Rail DIN - Power Supply 220/240V AC 50/60Hz - 24 V DC

DISCLAIMER:

All technical content within this document can be modified without notice. The content of the document is a under continual renewal. For losses due to fire, earthquake, third party access or other accidents, or intentional or accidental abuse, misuse, or use under abnormal conditions repairs are charged to the user. ADFweb.com S.r.l. will not be liable for accidental loss of use or inability to use this product, such as loss of business income. ADFweb.com S.r.l. shall not be liable for consequences of improper use.

OTHER REGULATIONS AND STANDARDS:**WEEE INFORMATION**

Disposal of old electrical and electronic equipment (as in the European Union and other European countries with separate collection systems).

— This symbol on the product or on its packaging indicates that this product may not be treated as household rubbish. Instead, it should be taken to an applicable collection point for the recycling of electrical and electronic equipment. If the product is disposed correctly, you will help prevent potential negative environmental factors and impact of human health, which could otherwise be caused by inappropriate disposal. The recycling of materials will help to conserve natural resources. For more information about recycling this product, please contact your local city office, your household waste disposal service or the shop where you purchased the product.

RESTRICTION OF HAZARDOUS SUBSTANCES DIRECTIVE

The device respects the 2002/95/EC Directive on the restriction of the use of certain hazardous substances in electrical and electronic equipment (commonly referred to as Restriction of Hazardous Substances Directive or RoHS).

CE MARKING

The product conforms with the essential requirements of the applicable EC directives.

WARRANTIES AND TECHNICAL SUPPORT:

For fast and easy technical support for your ADFweb.com SRL products, consult our internet support at www.adfweb.com.
Otherwise contact us at the address support@adfweb.com

RETURN POLICY:

If while using your product you have any problem and you wish to exchange or repair it, please do the following:

- Obtain a Product Return Number (PRN) from our internet support at www.adfweb.com. Together with the request, you need to provide detailed information about the problem.
- Send the product to the address provided with the PRN, having prepaid the shipping costs (shipment costs billed to us will not be accepted).

If the product is within the warranty of twelve months, it will be repaired or exchanged and returned within three weeks. If the product is no longer under warranty, you will receive a repair estimate.



ADFweb.com S.r.l.
Via Strada Nuova, 17
IT-31010 Mareno di Piave
TREVISO (Italy)
Phone +39.0438.30.91.31
Fax +39.0438.49.20.99
www.adfweb.com

