

# User Manual

Revision 1.000

English

## EtherCAT Slave / OPC UA Client - Converter

(Order Code: HD67E20-A1)

For Website information:

[www.adfweb.com?Product=HD67E20](http://www.adfweb.com?Product=HD67E20)

For Price information:

[www.adfweb.com?Price=HD67E20-A1](http://www.adfweb.com?Price=HD67E20-A1)

### Benefits and Main Features:

- ⊕ Very easy to configure
- ⊕ Triple Electrical isolation
- ⊕ Temperature range: -40°C/+85°C (-40°F/+185°F)



For other EtherCAT Slave products see also the following link:

#### Converter EtherCAT Slave to

- [www.adfweb.com?Product=HD67E00](http://www.adfweb.com?Product=HD67E00)
- [www.adfweb.com?Product=HD67E01](http://www.adfweb.com?Product=HD67E01)
- [www.adfweb.com?Product=HD67E02](http://www.adfweb.com?Product=HD67E02)
- [www.adfweb.com?Product=HD67E03](http://www.adfweb.com?Product=HD67E03)
- [www.adfweb.com?Product=HD67E04](http://www.adfweb.com?Product=HD67E04)
- [www.adfweb.com?Product=HD67E05](http://www.adfweb.com?Product=HD67E05)
- [www.adfweb.com?Product=HD67E06](http://www.adfweb.com?Product=HD67E06)
- [www.adfweb.com?Product=HD67E07](http://www.adfweb.com?Product=HD67E07)
- [www.adfweb.com?Product=HD67E08](http://www.adfweb.com?Product=HD67E08)
- [www.adfweb.com?Product=HD67E09](http://www.adfweb.com?Product=HD67E09)
- [www.adfweb.com?Product=HD67E10](http://www.adfweb.com?Product=HD67E10)
- [www.adfweb.com?Product=HD67E11](http://www.adfweb.com?Product=HD67E11)
- [www.adfweb.com?Product=HD67E12](http://www.adfweb.com?Product=HD67E12)
- [www.adfweb.com?Product=HD67E14](http://www.adfweb.com?Product=HD67E14)
- [www.adfweb.com?Product=HD67E15](http://www.adfweb.com?Product=HD67E15)
- [www.adfweb.com?Product=HD67E16](http://www.adfweb.com?Product=HD67E16)
- [www.adfweb.com?Product=HD67E17](http://www.adfweb.com?Product=HD67E17)
- [www.adfweb.com?Product=HD67E18](http://www.adfweb.com?Product=HD67E18)
- [www.adfweb.com?Product=HD67E19](http://www.adfweb.com?Product=HD67E19)
- [www.adfweb.com?Product=HD67E21](http://www.adfweb.com?Product=HD67E21)
- [www.adfweb.com?Product=HD67E22](http://www.adfweb.com?Product=HD67E22)
- [www.adfweb.com?Product=HD67E23](http://www.adfweb.com?Product=HD67E23)
- [www.adfweb.com?Product=HD67E24](http://www.adfweb.com?Product=HD67E24)
- [www.adfweb.com?Product=HD67E25](http://www.adfweb.com?Product=HD67E25)
- [www.adfweb.com?Product=HD67E26](http://www.adfweb.com?Product=HD67E26)
- [www.adfweb.com?Product=HD67E27](http://www.adfweb.com?Product=HD67E27)
- [www.adfweb.com?Product=HD67E28](http://www.adfweb.com?Product=HD67E28)
- [www.adfweb.com?Product=HD67879](http://www.adfweb.com?Product=HD67879)

- (Serial)**
- (Modbus Master)**
- (Modbus Slave)**
- (Modbus TCP Master)**
- (Modbus TCP Slave)**
- (BACnet Master)**
- (BACnet Slave)**
- (CAN)**
- (CANopen)**
- (DeviceNet Master)**
- (DeviceNet Slave)**
- (DMX)**
- (Ethernet)**
- (IEC61850 Master)**
- (IEC61850 Slave)**
- (J1939)**
- (MQTT)**
- (NMEA0183)**
- (NMEA 2000)**
- (OPC UA Server)**
- (PROFINET Master)**
- (PROFINET Slave)**
- (SNMP Manager)**
- (SNMP Agent)**
- (EtherNet/IP Master)**
- (EtherNet/IP Slave)**
- (S7comm Client)**
- (IO-Link Master)**



User Manual



**INDEX:**

	Page
INDEX	2
UPDATED DOCUMENTATION	2
REVISION LIST	2
WARNING	2
TRADEMARKS	2
SECURITY ALERT	3
EXAMPLE OF CONNECTION	4
CONNECTION SCHEME	5
CHARACTERISTICS	6
CONFIGURATION	6
POWER SUPPLY	7
FUNCTION MODES	8
LEDS	9
ETHERCAT	10
ETHERNET	11
USE OF COMPOSITOR SW67E20	12
NEW CONFIGURATION / OPEN CONFIGURATION	13
SOFTWARE OPTIONS	14
SET COMMUNICATION	16
ETHERCAT SET ACCESS	17
OPC UA CLIENT ACCESS	19
ETHERCAT ESI FILE	24
UPDATE DEVICE	25
MECHANICAL DIMENSIONS	27
ORDERING INFORMATIONS	28
ACCESSORIES	28
DISCLAIMER	29
OTHER REGULATIONS AND STANDARDS	29
WARRANTIES AND TECHNICAL SUPPORT	30
RETURN POLICY	30

**UPDATED DOCUMENTATION:**

Dear customer, we thank you for your attention and we remind you that you need to check that the following document is:

- Updated
- Related to the product you own

To obtain the most recently updated document, note the “document code” that appears at the top right-hand corner of each page of this document.

With this “Document Code” go to web page [www.adfweb.com/download/](http://www.adfweb.com/download/) and search for the corresponding code on the page. Click on the proper “Document Code” and download the updates.

**REVISION LIST:**

Revision	Date	Author	Chapter	Description
1.000	18/09/2020	Ff	All	First Release

**WARNING:**

ADFweb.com reserves the right to change information in this manual about our product without warning. ADFweb.com is not responsible for any error this manual may contain.

**TRADEMARKS:**

All trademarks mentioned in this document belong to their respective owners.

**SECURITY ALERT:****GENERAL INFORMATION**

To ensure safe operation, the device must be operated according to the instructions in the manual. When using the device, legal and safety regulation are required for each individual application. The same applies also when using accessories.

**INTENDED USE**

Machines and systems must be designed so the faulty conditions do not lead to a dangerous situation for the operator (i.e. independent limit switches, mechanical interlocks, etc.).

**QUALIFIED PERSONNEL**

The device can be used only by qualified personnel, strictly in accordance with the specifications. Qualified personnel are persons who are familiar with the installation, assembly, commissioning and operation of this equipment and who have appropriate qualifications for their job.

**RESIDUAL RISKS**

The device is state-of-the-art and is safe. The instruments can represent a potential hazard if they are inappropriately installed and operated by untrained personnel. These instructions refer to residual risks with the following symbol:



This symbol indicates that non-observance of the safety instructions is a danger for people that could lead to serious injury or death and / or the possibility of damage.

**CE CONFORMITY**

The declaration is made by our company. You can send an email to [support@adfweb.com](mailto:support@adfweb.com) or give us a call if you need it.

**EXAMPLE OF CONNECTION:**

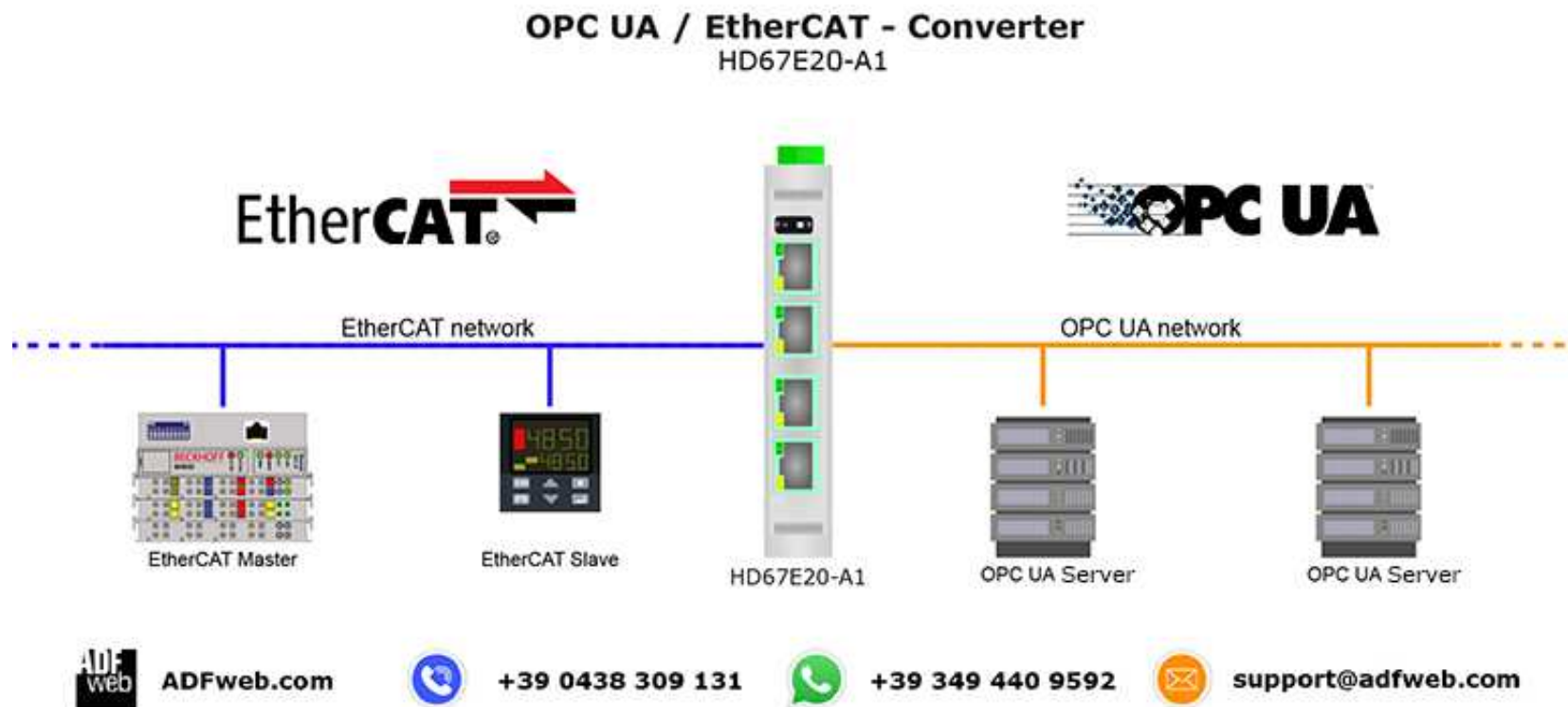

**CONNECTION SCHEME:**

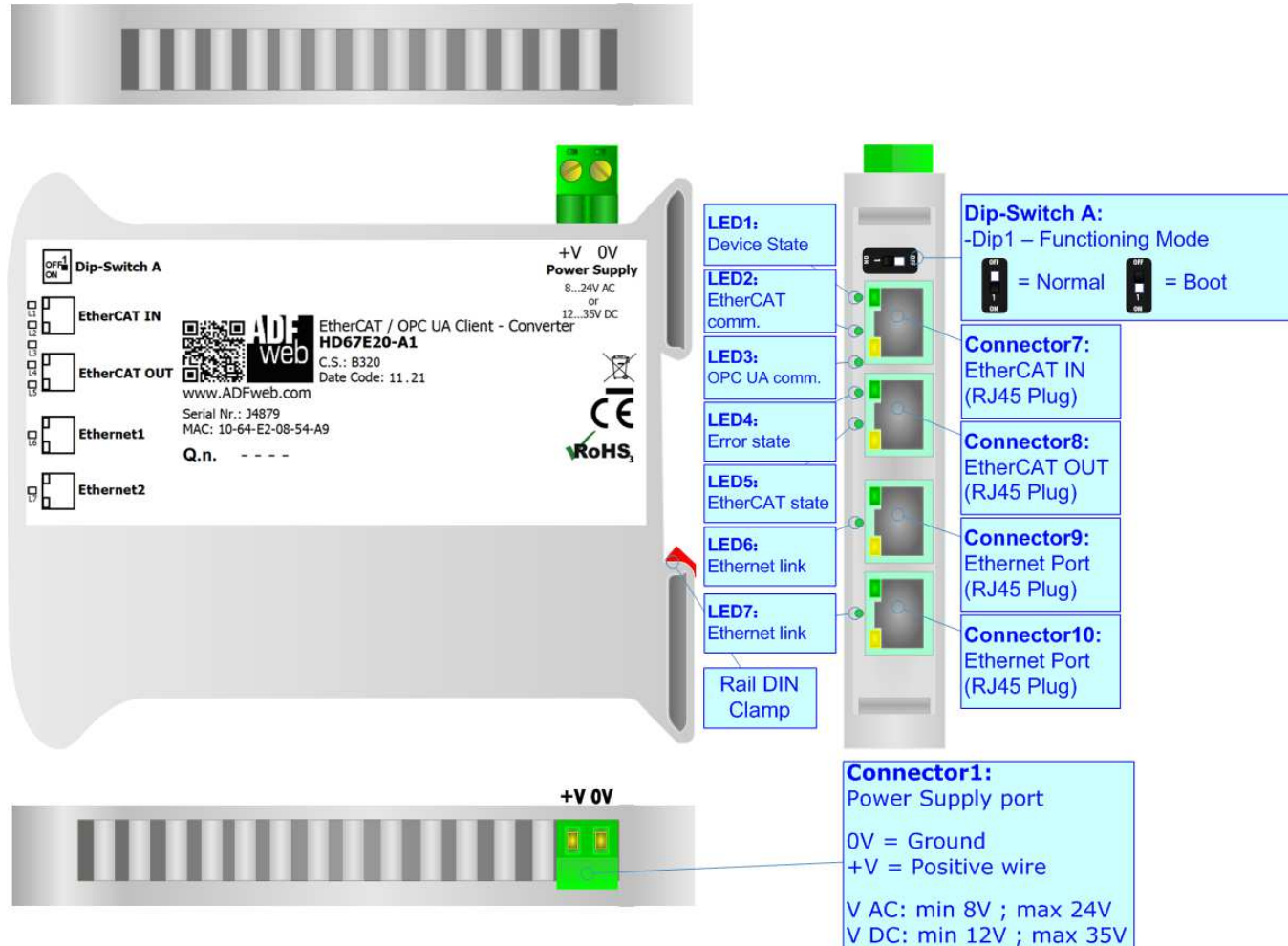

Figure 1: Connection scheme for HD67E20-A1

**CHARACTERISTICS:**

The HD67E20-A1 are EtherCAT / OPC UA - Converters.

It allows for the following characteristics:

- Isolation between EtherCAT – OPC UA – Power Supply;
- Two-directional information between EtherCAT bus and OPC UA bus;
- Mountable on 35mm Rail DIN;
- Wide power supply input range: 8...24V AC or 12...35V DC;
- Wide temperature range: -40°C / 85°C [-40°F / +185°F].



**CONFIGURATION:**

You need Compositor SW67E20 software on your PC in order to perform the following:

- Define the parameters of EtherCAT line;
- Define the parameters of OPC UA line;
- Define EtherCAT variables to read and write;
- Define the list of OPC UA servers connected to the converter;
- Export the ESI file for configuration of EtherCAT Master;
- Update the device.

**POWER SUPPLY:**

The devices can be powered at 8...24V AC and 12...35V DC. For more details see the two tables below.

VAC 		VDC 	
Vmin	Vmax	Vmin	Vmax
8V	24V	12V	35V

Consumption at 24V DC:

Device	Consumption [W/VA]
HD67E20-A1	3.5

**Caution: Do not reverse the polarity power**

**Connector1:**  
 Power Supply port  
 0V = Ground  
 +V = Positive wire  
 V AC: min 8V ; max 24V  
 V DC: min 12V ; max 35V

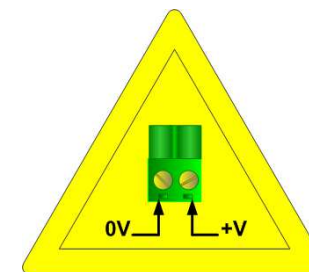
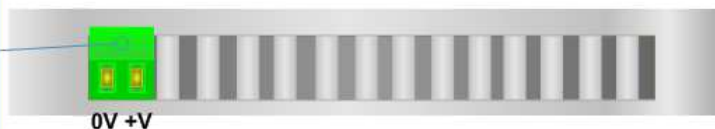

HD67E20-A1

**FUNCTION MODES:**

The device has got two function modes depending on the position of the 'Dip1 of Dip-Switch A':

- The first, with 'Dip1 of Dip-Switch A' at "OFF" position, is used for the normal working of the device.
- The second, with 'Dip1 of Dip-Switch A' at "ON" position, is used for uploading the Project and/or Firmware.

For the operations to follow for the updating, see 'UPDATE DEVICE' section.

According to the functioning mode, the LEDs will have specific functions, see 'LEDS' section.

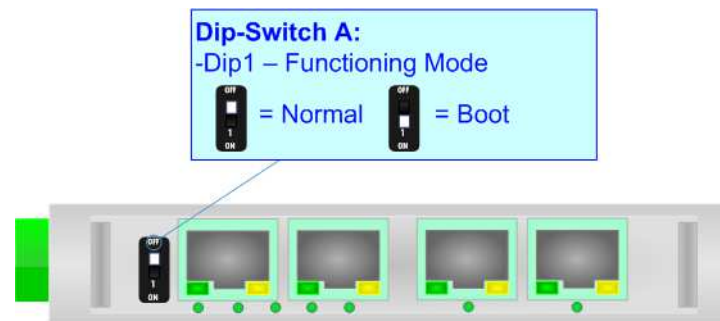



**LEDS:**

The device has got seven LEDs that are used to give information about the functioning status.  
The various meanings of the LEDs are described in the table below.

LED	Normal Mode	Boot Mode
1: Device State (green)	Blinks slowly (~1Hz)	<b>Blinks quickly:</b> Boot state <b>Blinks very slowly (~0.5Hz):</b> update in progress
2: EtherCAT comm. (green)	It blinks when EtherCAT communication is running	<b>Blinks quickly:</b> Boot state <b>Blinks very slowly (~0.5Hz):</b> update in progress
3: OPC UA comm. (green)	It blinks when OPC UA communication is running	<b>Blinks quickly:</b> Boot state <b>Blinks very slowly (~0.5Hz):</b> update in progress
4: Error state (green)	<b>ON:</b> An error in the communication busses occurs <b>OFF:</b> No errors are present	<b>Blinks quickly:</b> Boot state <b>Blinks very slowly (~0.5Hz):</b> update in progress
5: EtherCAT state (green)	<b>OFF:</b> EtherCAT Master not connected <b>Blinking:</b> EtherCAT Master is connecting <b>ON:</b> EtherCAT Master is connected	<b>Blinks quickly:</b> Boot state <b>Blinks very slowly (~0.5Hz):</b> update in progress
6: Ethernet1 link (green)	<b>ON:</b> Ethernet cable connected <b>OFF:</b> Ethernet cable disconnected	<b>ON:</b> Ethernet cable connected <b>OFF:</b> Ethernet cable disconnected
7: Ethernet2 link (green)	<b>ON:</b> Ethernet cable connected <b>OFF:</b> Ethernet cable disconnected	<b>ON:</b> Ethernet cable connected <b>OFF:</b> Ethernet cable disconnected

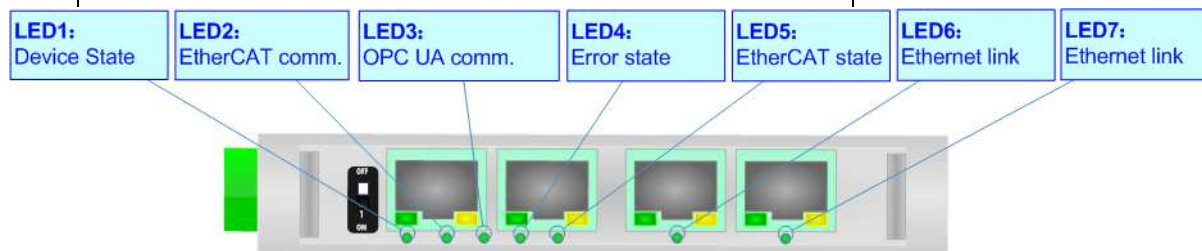

## ETHERCAT

**EtherCAT** (Ethernet for Control Automation Technology) is an Ethernet-based fieldbus system, invented by Beckhoff Automation.

The protocol is standardized in OPC UA and is suitable for both hard and soft real-time computing requirements in automation technology. With EtherCAT, the standard Ethernet packet or frame (according to IEEE 802.3) is no longer received, interpreted, and copied as process data at every node. The EtherCAT slave devices read the data addressed to them while the telegram passes through the device, processing data "on the fly". In other words, real-time data and messages are prioritized over more general, less time-sensitive or heavy load data.

The converter has two EtherCAT ports, one is used as Input port (Connector7) and it will receive the incoming messages from the Master, the other is used as Output port (Connector8) and it will forward the messages to the others nodes of the network.

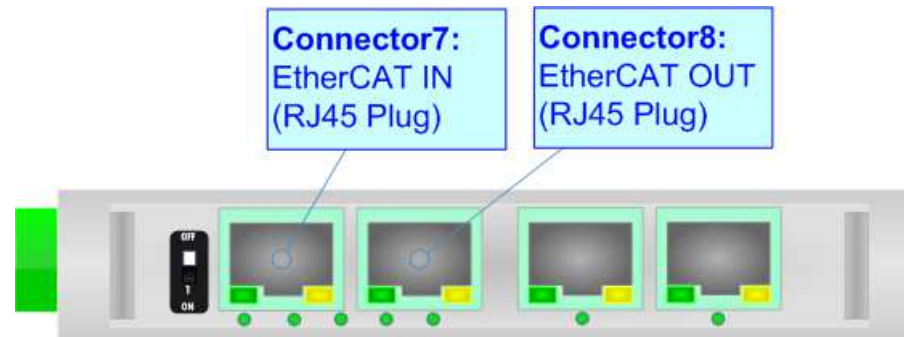

**ETHERNET:**

The Ethernet port is used for programming the device and for OPC UA communication.

Ethernet connection and the updating of the converter must be made using Connector9 and/or Connector10 of the HD67E20-A1 with at least a Category 5E cable. The maximum length of the cable should not exceed 100m. The cable has to conform to the T568 norms relative to connections in cat.5 up to 100 Mbps. To connect the device to an Hub/Switch is recommended the use of a straight cable, to connect the device to a PC/PLC/other is recommended the use of a cross cable.

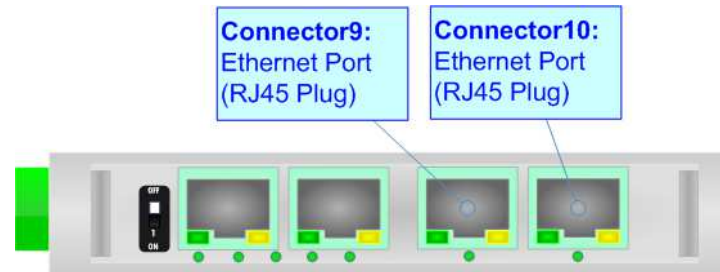

### USE OF COMPOSITOR SW67E20:

To configure the Converter, use the available software that runs with Windows called SW67E20. It is downloadable on the site [www.adfweb.com](http://www.adfweb.com) and its operation is described in this document. *(This manual is referenced to the last version of the software present on our web site).* The software works with MSWindows (XP, Vista, Seven, 8, 10; 32/64bit).

When launching the SW67E20, the window below appears (Fig. 2).



**Note:**

It is necessary to have installed .Net Framework 4.



Figure 2: Main window for SW67E20

**NEW CONFIGURATION / OPEN CONFIGURATION:**

The “**New Configuration**” button creates the folder which contains the entire device’s configuration.



A device’s configuration can also be imported or exported:

- To clone the configurations of a programmable “EtherCAT / OPC UA Client - Converter” in order to configure another device in the same manner, it is necessary to maintain the folder and all its contents;
- To clone a project in order to obtain a different version of the project, it is sufficient to duplicate the project folder with another name and open the new folder with the button “**Open Configuration**”.

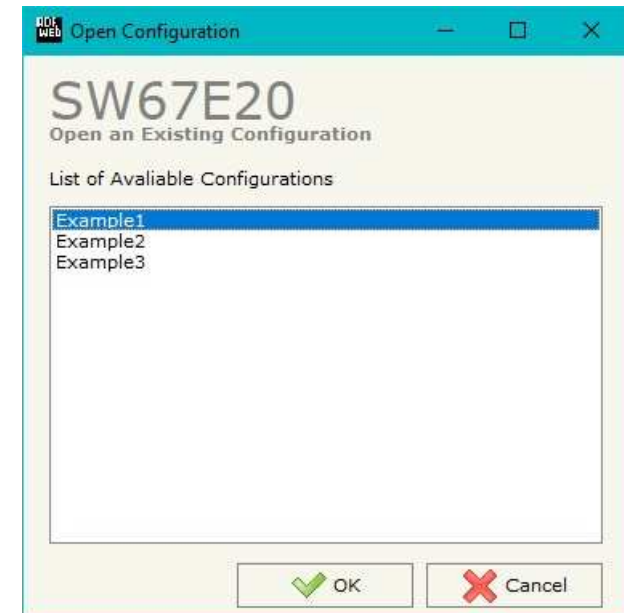

## SOFTWARE OPTIONS:

By pressing the “**Settings**” () button there is the possibility to change the language of the software and check the updatings for the compositor.

In the section “Language” it is possible to change the language of the software.

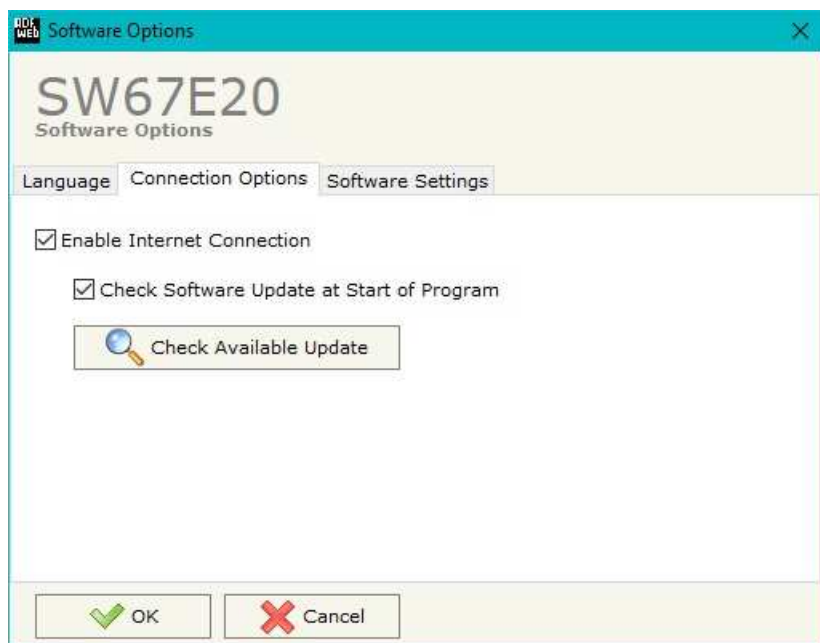

In the section “Connection Options”, it is possible to check if there are some updatings of the software compositor in ADFweb.com website. Checking the option “**Check Software Update at Start of Program**”, the SW67E20 checks automatically if there are updatings when it is launched.



In the section "Software Settings", it is possible to enable/disable some keyboard's commands for an easier navigation inside the tables contained in the different sections of the software.

## SET COMMUNICATION:

This section define the fundamental communication parameters of two buses, EtherCAT and OPC UA.

By Pressing the **"Set Communication"** button from the main window for SW67E20 (Fig. 2) the window "Set Communication" appears (Fig. 3).

The means of the fields for "EtherCAT Slave" are:

- In the field **"Revision Number"** the revision number of the converter is defined;
- In the field **"Slave Name"** the name of the converter is defined;
- In the field **"Node Address"** the ID of the converter is defined.

The means of the fields for "OPC UA Client" are:

- In the field **"IP Address"** the IP address of the converter is defined;
- In the field **"Subnet Mask"** the SubNet Mask of the converter is defined;
- In the field **"GATEWAY"** the default gateway of the net is defined. This feature can be enabled or disabled pressing the Check Box field. This feature is used for going out of the net;
- In the field **"DNS"** the DNS address is defined. This field is required if the server address is define by URL and not IP Address.

The means of the fields for "NTP" are:

- In the field **"Server URL"** the URL or the IP Address of the NTP Server is defined;
- In the field **"Poll Time (seconds)"** the polling time for the time synchronization is defined.

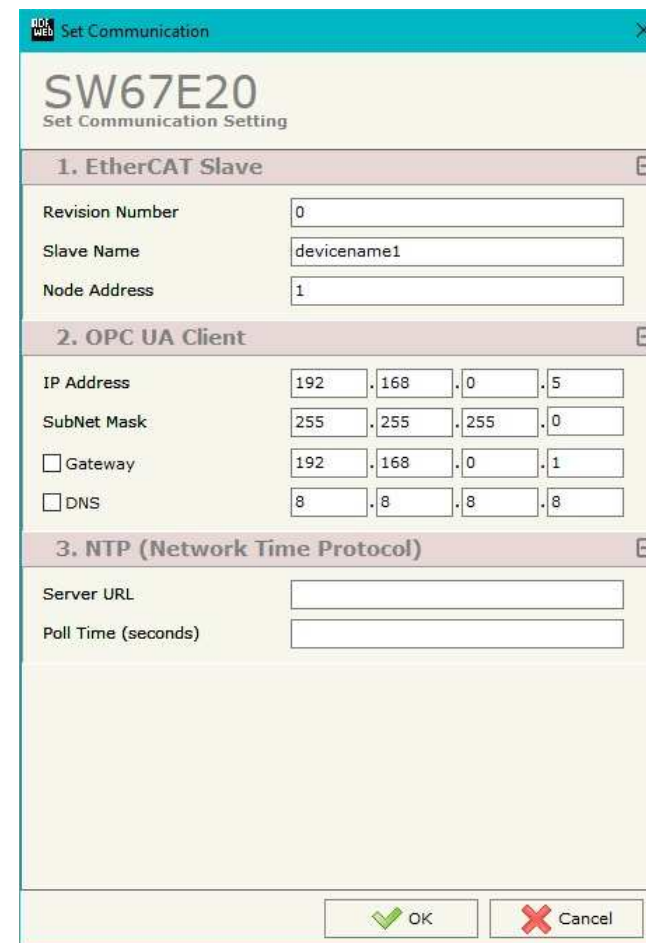

Figure 3: "Set Communication setting" window



## ETHERCAT SET ACCESS:

By Pressing the “**EtherCAT Set Access**” button from the main window for SW67E20 (Fig. 2) the window “EtherCAT Slave Set Access” appears (Fig. 4).

This section is used to define the EtherCAT variables readable by the EtherCAT Master (Slave To Master) and the EtherCAT variables writable by the EtherCAT Master (Master To Slave).

### SLAVE TO MASTER



Figure 4a: “EtherCAT Slave Set Access → Slave To Master” window

The means of the fields are:

- If the field “**Enable**” is checked, the EtherCAT variable is enabled;
- In the field “**Type**” the data format of the EtherCAT variable is defined;
- In the field “**Length**” the dimension of the EtherCAT variable is defined;
- In the field “**Name**” the name of the EtherCAT variable is defined;
- In the field “**Init Value**” the default value of the EtherCAT variable is defined;
- In the field “**Position**” the starting address of the EtherCAT array where the variable is mapped is defined;
- In the field “**Start Bit**” the starting bit of the selected Position where the variable is mapped is defined;
- In the field “**Mnemonic**” a description of the variable is defined.

**MASTER TO SLAVE**



Figure 4b: "EtherCAT Slave Set Access → Master To Slave" window

The means of the fields are:

- If the field "**Enable**" is checked, the EtherCAT variable is enabled;
- In the field "**Type**" the data format of the EtherCAT variable is defined;
- In the field "**Length**" the dimension of the EtherCAT variable is defined;
- In the field "**Name**" the name of the EtherCAT variable is defined;
- In the field "**Position**" the starting address of the EtherCAT array where the variable is mapped is defined;
- In the field "**Start Bit**" the starting bit of the selected Position where the variable is mapped is defined;
- In the field "**Mnemonic**" a description of the variable is defined.

**OPC UA CLIENT ACCESS:**

By Pressing the “**OPC UA Client Access**” button from the main window for SW67E20 (Fig. 2) the window “OPC UA Client Access” appears (Fig. 5).

This section is used to define the list of the OPC UA Servers to read/write with the OPC UA Client.

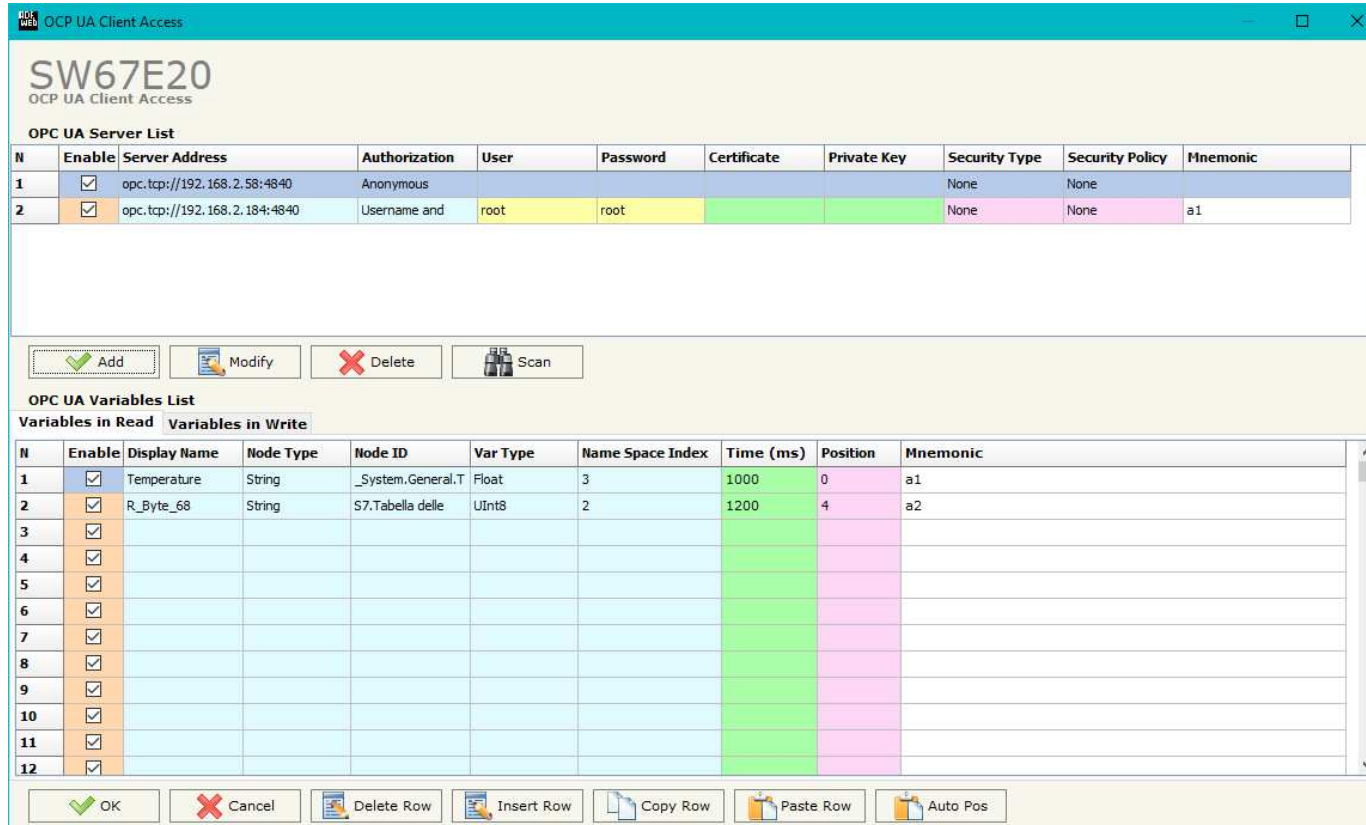

Figure 5: “OPC UA Client Access” window

By clicking on **"Add"**, it is possible to add a new OPC UA Server inserting its characteristics (Server Address, Authorization, Security Type...). The window "Add OPC UA Server" appears (Fig. 6). By clicking on **"Modify"**, it is possible to change these characteristics for the selected Server. The window "Modify OPC UA Server" appears (Fig. 7).



Figure 6: "Add OPC UA Server"



Figure 7: "Modify OPC UA Server"

By clicking on **“Scan”**, it is possible to get the list of available variables from the selected Server. The window **“Scan Server OPC UA”** appears (Fig. 8).

N	Read	Write	Display Name	Node Type	Node Identifier	Data Type	Name Space Index	Read/Write
1	<input checked="" type="checkbox"/>	<input type="checkbox"/>	Temperature	String	._System.General.Temperature	Float	3	Read
2	<input checked="" type="checkbox"/>	<input checked="" type="checkbox"/>	R_Byte_68	String	S7.Tabella delle variabili_1.R_Byte_68	UInt8	2	Read/Write
3	<input checked="" type="checkbox"/>	<input checked="" type="checkbox"/>	R_Byte_69	String	S7.Tabella delle variabili_1.R_Byte_69	UInt8	2	Read/Write
4	<input checked="" type="checkbox"/>	<input checked="" type="checkbox"/>	R_Word_70	String	S7.Tabella delle variabili_1.R_Word_70	UInt16	2	Read/Write
5	<input checked="" type="checkbox"/>	<input checked="" type="checkbox"/>	R_Real_72	String	S7.Tabella delle variabili_1.R_Real_72	UInt32	2	Read/Write
6	<input checked="" type="checkbox"/>	<input checked="" type="checkbox"/>	R_Int16_76	String	S7.Tabella delle variabili_1.R_Int16_76	UInt16	2	Read/Write
7	<input checked="" type="checkbox"/>	<input checked="" type="checkbox"/>	R_Int32_78	String	S7.Tabella delle variabili_1.R_Int32_78	UInt32	2	Read/Write
8	<input checked="" type="checkbox"/>	<input checked="" type="checkbox"/>	R_Bit_82.0	String	S7.Tabella delle variabili_1.R_Bit_82.0	Boolean	2	Read/Write
9	<input checked="" type="checkbox"/>	<input checked="" type="checkbox"/>	R_Bit_82.1	String	S7.Tabella delle variabili_1.R_Bit_82.1	Boolean	2	Read/Write

Figure 8: **“Scan Server OPC UA”** window

The means of the checkboxes inside the table are:

- If the field **“Read”** is checked, the variable can be read;
- If the field **“Write”** is checked, the variable can be written.



**Note:**

For each variable, it is possible to uncheck these fields and the variable will not be used in read/write.

After the scan, the selected variables will appear in “Variables in Read” and/or “Variables in Write” sections, in the lower part of the window “OPC UA Client Access” (Fig. 5).

The “Variables in Read” section is used to define the OPC UA variables to make available on OPC UA side (Fig. 9).

OPC UA Variables List									
Variables in Read					Variables in Write				
N	Enable	Display Name	Node Type	Node ID	Var Type	Name Space Index	Time (ms)	Position	Mnemonic
1	<input checked="" type="checkbox"/>	Temperature	String	_System.General.T	Float	3	1000	0	
2	<input checked="" type="checkbox"/>	R_Byte_68	String	S7.Tabella delle	UInt8	2	2000	4	
3	<input checked="" type="checkbox"/>	R_Byte_69	String	S7.Tabella delle	UInt8	2	2000	5	
4	<input checked="" type="checkbox"/>	R_Word_70	String	S7.Tabella delle	UInt16	2	2000	6	
5	<input checked="" type="checkbox"/>	R_Real_72	String	S7.Tabella delle	UInt32	2	2000	8	
6	<input checked="" type="checkbox"/>	R_Int16_76	String	S7.Tabella delle	UInt16	2	2000	12	
7	<input checked="" type="checkbox"/>	R_Int32_78	String	S7.Tabella delle	UInt32	2	2000	14	
8	<input checked="" type="checkbox"/>	R_Bit_82.0	String	S7.Tabella delle	Boolean	2	2000	18	
9	<input checked="" type="checkbox"/>	R_Bit_82.1	String	S7.Tabella delle	Boolean	2	2000	19	
10	<input checked="" type="checkbox"/>	R_Bit_82.2	String	S7.Tabella delle	Boolean	2	2000	20	
11	<input checked="" type="checkbox"/>	R_Bit_82.3	String	S7.Tabella delle	Boolean	2	2000	21	

Figure 9: “Variables in Read” section

The means of the fields are:

- If the field “**Enable**” is checked, the OPC UA variable is enabled;
- In the field “**Display name**” the name of the OPC UA variable is defined;
- In the field “**Node Type**” the type of the OPC UA node, which includes the variable, is defined;
- In the field “**Node ID**” the name of the OPC UA node, which includes the variable, is defined;
- In the field “**Var Type**” the data format of the OPC UA variable is defined;
- In the field “**Name Space Index**” the Name Space Index of the node, which includes the variable, is defined;
- In the field “**Time (ms)**” the delay in ms between two readings of the variable is defined;
- In the field “**Position**” the starting byte of the internal memory arrays where saving the value is defined;
- In the field “**Mnemonic**” a description of the variable is defined.



The "Variables in Write" section is used to define the OPC UA variables to write from OPC UA side (Fig. 9).

OPC UA Variables List												
Variables in Read												Variables in Write
N	Enable	Display Name	Node Type	Node ID	Var Type	Name Space Index	On Change	On CMD	On Timer	Time (ms)	Position	Mnemonic
1	<input checked="" type="checkbox"/>	R_Byte_68	String	S7.Tabella delle	UInt8	2	<input checked="" type="checkbox"/>	<input type="checkbox"/>	<input type="checkbox"/>	0	0	
2	<input checked="" type="checkbox"/>	R_Byte_69	String	S7.Tabella delle	UInt8	2	<input checked="" type="checkbox"/>	<input type="checkbox"/>	<input type="checkbox"/>	0	1	
3	<input checked="" type="checkbox"/>	R_Word_70	String	S7.Tabella delle	UInt16	2	<input checked="" type="checkbox"/>	<input type="checkbox"/>	<input type="checkbox"/>	0	2	
4	<input checked="" type="checkbox"/>	R_Real_72	String	S7.Tabella delle	UInt32	2	<input checked="" type="checkbox"/>	<input type="checkbox"/>	<input type="checkbox"/>	0	4	
5	<input checked="" type="checkbox"/>	R_Int16_76	String	S7.Tabella delle	UInt16	2	<input checked="" type="checkbox"/>	<input type="checkbox"/>	<input type="checkbox"/>	0	8	
6	<input checked="" type="checkbox"/>	R_Int32_78	String	S7.Tabella delle	UInt32	2	<input checked="" type="checkbox"/>	<input type="checkbox"/>	<input type="checkbox"/>	0	10	
7	<input checked="" type="checkbox"/>	R_Bit_82.0	String	S7.Tabella delle	Boolean	2	<input checked="" type="checkbox"/>	<input type="checkbox"/>	<input type="checkbox"/>	0	14	
8	<input checked="" type="checkbox"/>	R_Bit_82.1	String	S7.Tabella delle	Boolean	2	<input checked="" type="checkbox"/>	<input type="checkbox"/>	<input type="checkbox"/>	0	15	
9	<input checked="" type="checkbox"/>	R_Bit_82.2	String	S7.Tabella delle	Boolean	2	<input checked="" type="checkbox"/>	<input type="checkbox"/>	<input type="checkbox"/>	0	16	
10	<input checked="" type="checkbox"/>	R_Bit_82.3	String	S7.Tabella delle	Boolean	2	<input checked="" type="checkbox"/>	<input type="checkbox"/>	<input type="checkbox"/>	0	17	
11	<input checked="" type="checkbox"/>	R_Bit_82.4	String	S7.Tabella delle	Boolean	2	<input checked="" type="checkbox"/>	<input type="checkbox"/>	<input type="checkbox"/>	0	18	

OK
 Cancel
 Delete Row
 Insert Row
 Copy Row
 Paste Row
 Auto Pos

Figure 9: "Variables in Write" section

In "Variables in Write" section (Fig. 9), the means of the fields are:

- If the field "Enable" is checked, the OPC UA variable is enabled;
- In the field "Display name" the name of the OPC UA variable is defined;
- In the field "Node Type" the type of the OPC UA node, which includes the variable, is defined;
- In the field "Node ID" the name of the OPC UA node, which includes the variable, is defined;
- In the field "Var Type" the data format of the OPC UA variable is defined;
- In the field "Name Space Index" the Name Space Index of the node, which includes the variable, is defined;
- If the field "On Change" is checked, the OPC UA variable is sent when the data on EtherCAT changes the value;
- If the field "On CMD" is checked, the OPC UA variable is sent when a EtherCAT message is received;
- If the field "On Timer" is checked, the OPC UA variable is sent cyclically;
- In the field "Time (ms)" the delay in ms between two writings of the variable is defined (if "On Timer" is checked);

- In the field "**Position**" the starting byte of the internal memory arrays where getting the value is defined;
- In the field "**Mnemonic**" a description of the variable is defined.

 Note:  
By clicking on "**Auto Pos**", the position of the internal memory arrays where saving/getting the value of variable is automatically calculated.

 Note:  
A variable can be added manually in "Variables in Read" and/or "Variables in Write" sections without scanning the OPC UA Server.

#### **ETHERCAT ESI FILE:**

By pressing the "**EtherCAT ESI File**" button it is possible to save the ESI file for the EtherCAT side of the converter. The ESI file is used to configure the EtherCAT Master.



### UPDATE DEVICE:

By pressing the **“Update Device”** button, it is possible to load the created Configuration into the device; and also the Firmware, if necessary. This by using the Ethernet port.

If you don't know the actual IP address of the device you have to use this procedure:

- Turn OFF the Device;
- Put Dip1 of 'Dip-Switch A' in ON position;
- Turn ON the device
- Connect the Ethernet cable;
- Insert the IP **“192.168.2.205”**;
- Select which operations you want to do;
- Press the **“Execute update firmware”** button to start the upload;
- When all the operations are “OK” turn OFF the Device;
- Put Dip1 of 'Dip-Switch A' in OFF position;
- Turn ON the device.

If you know the actual IP address of the device, you have to use this procedure:

- Turn ON the Device with the Ethernet cable inserted;
- Insert the actual IP of the Converter;
- Select which operations you want to do;
- Press the **“Execute update firmware”** button to start the upload;
- When all the operations are “OK” the device automatically goes at Normal Mode.

At this point the configuration/firmware on the device is correctly updated.

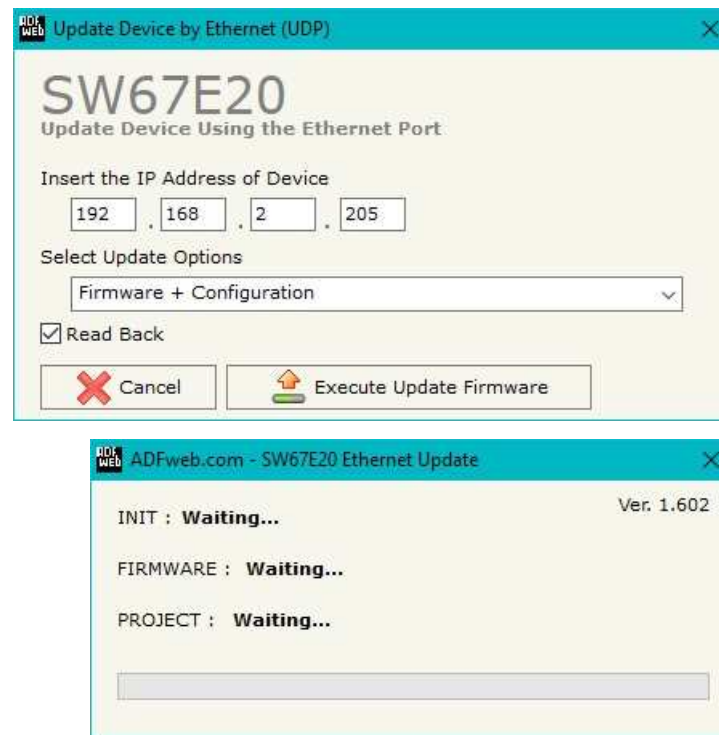

Figure 10: “Update device” windows



**Note:**

When you receive the device, for the first time, you also have to update the Firmware in the HD67E20 device.



**Warning:**

If Fig. 11 appears when you try to do the Update try these points before seeking assistance:

- Try to repeat the operations for the updating;
- Try with another PC;
- Try to restart the PC;
- Check the LAN settings;
- If you are using the program inside a Virtual Machine, try to use in the main Operating System;
- If you are using Windows Seven, Vista, 8 or 10 make sure that you have the administrator privileges;
- In case you have to program more than one device, using the "UDP Update", you have to cancel the ARP table every time you connect a new device on Ethernet. For do this you have to launch the "Command Prompt" and write the command "arp -d". Pay attention that with Windows Vista, Seven, 8, 10 you have to launch the "Command Prompt" with Administrator Rights;
- Pay attention at Firewall lock.

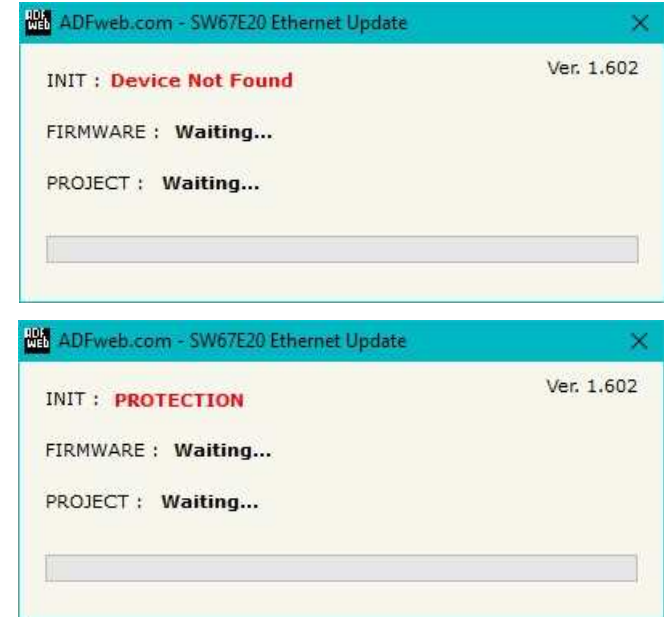

Figure 11: "Error" window



**Warning:**

In the case of HD67E20 you have to use the software "HD67E20": [www.adfweb.com/download/filefold/SW67E20.zip](http://www.adfweb.com/download/filefold/SW67E20.zip).

**MECHANICAL DIMENSIONS:**

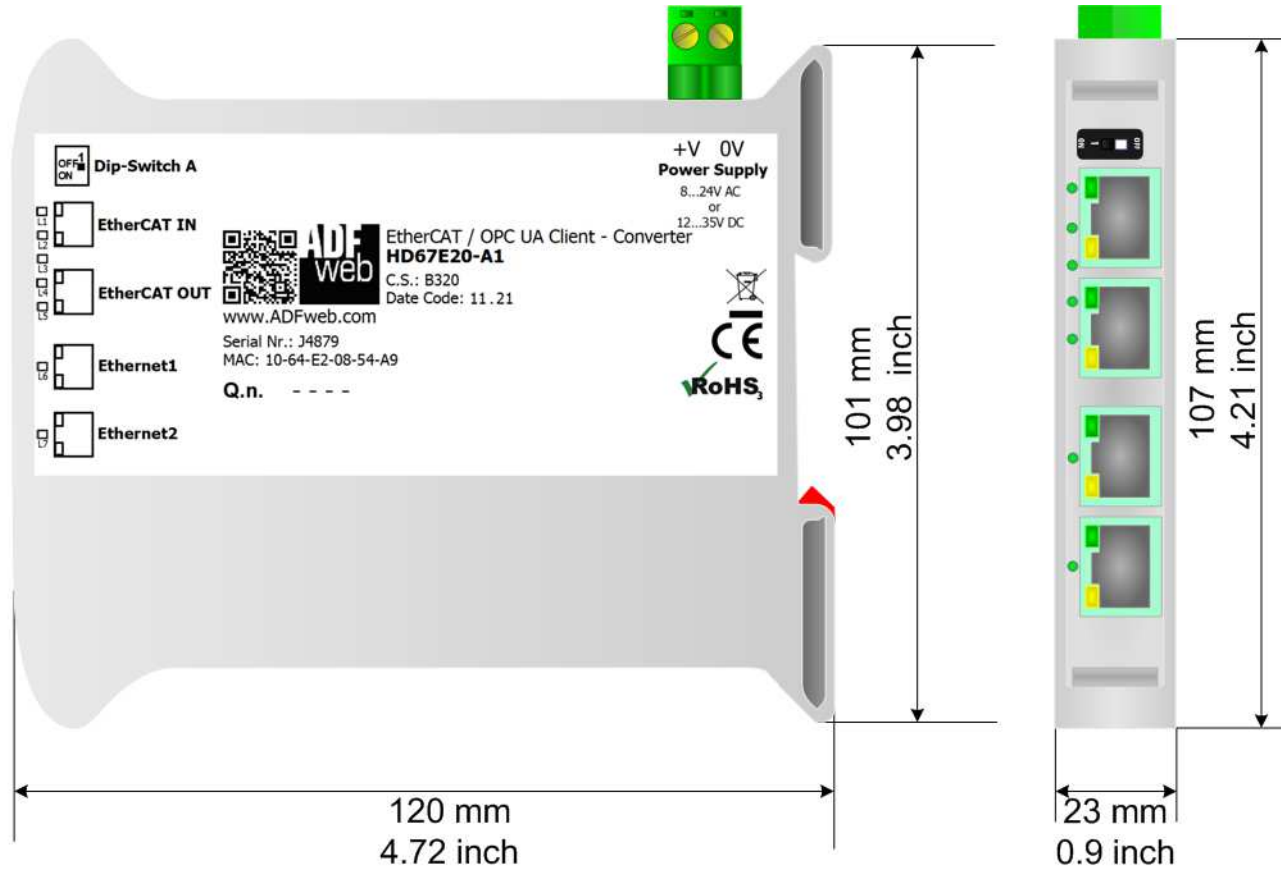

Housing: PVC  
Weight: 200g (Approx)

Figure 12: Mechanical dimensions scheme for HD67E20-A1

**ORDERING INFORMATIONS:**

The ordering part number is formed by a valid combination of the following:

**HD67E20 - xx**

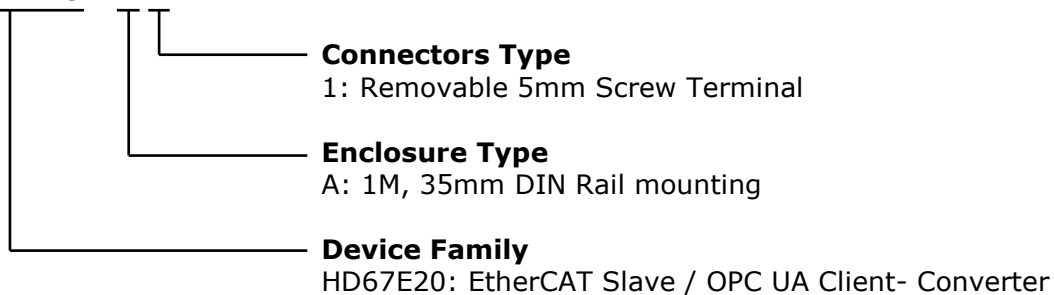

Order Code: **HD67E20-A1** - EtherCAT Slave / OPC UA Client - Converter

**ACCESSORIES:**

Order Code: **AC34011** - 35mm Rail DIN - Power Supply 220/240V AC 50/60Hz - 12 V DC

Order Code: **AC34012** - 35mm Rail DIN - Power Supply 220/240V AC 50/60Hz - 24 V DC

**DISCLAIMER:**

All technical content within this document can be modified without notice. The content of the document is a under continual renewal. For losses due to fire, earthquake, third party access or other accidents, or intentional or accidental abuse, misuse, or use under abnormal conditions repairs are charged to the user. ADFweb.com S.r.l. will not be liable for accidental loss of use or inability to use this product, such as loss of business income. ADFweb.com S.r.l. shall not be liable for consequences of improper use.

**OTHER REGULATIONS AND STANDARDS:****WEEE INFORMATION**

Disposal of old electrical and electronic equipment (as in the European Union and other European countries with separate collection systems).

— This symbol on the product or on its packaging indicates that this product may not be treated as household rubbish. Instead, it should be taken to an applicable collection point for the recycling of electrical and electronic equipment. If the product is disposed correctly, you will help prevent potential negative environmental factors and impact of human health, which could otherwise be caused by inappropriate disposal. The recycling of materials will help to conserve natural resources. For more information about recycling this product, please contact your local city office, your household waste disposal service or the shop where you purchased the product.

**RESTRICTION OF HAZARDOUS SUBSTANCES DIRECTIVE**

The device respects the 2002/95/EC Directive on the restriction of the use of certain hazardous substances in electrical and electronic equipment (commonly referred to as Restriction of Hazardous Substances Directive or RoHS).

**CE MARKING**

The product conforms with the essential requirements of the applicable EC directives.

**WARRANTIES AND TECHNICAL SUPPORT:**

For fast and easy technical support for your ADFweb.com SRL products, consult our internet support at [www.adfweb.com](http://www.adfweb.com). Otherwise contact us at the address [support@adfweb.com](mailto:support@adfweb.com)

**RETURN POLICY:**

If while using your product you have any problem and you wish to exchange or repair it, please do the following:

- Obtain a Product Return Number (PRN) from our internet support at [www.adfweb.com](http://www.adfweb.com). Together with the request, you need to provide detailed information about the problem.
- Send the product to the address provided with the PRN, having prepaid the shipping costs (shipment costs billed to us will not be accepted).

If the product is within the warranty of twelve months, it will be repaired or exchanged and returned within three weeks. If the product is no longer under warranty, you will receive a repair estimate.



**ADFweb.com S.r.l.**  
Via Strada Nuova, 17  
IT-31010 Mareno di Piave  
TREVISO (Italy)  
Phone +39.0438.30.91.31  
Fax +39.0438.49.20.99  
[www.adfweb.com](http://www.adfweb.com)

