

User Manual

Revision 1.200
English

CAN / Ethernet - Converter

(Order Code: HD67644-A1, HD67644-B2, HD67644-WiFi-B2)

For Website information:

www.adfweb.com?Product=HD67644

For Price information:

www.adfweb.com?Price=HD67644-A1

www.adfweb.com?Price=HD67644-B2

www.adfweb.com?Price=HD67644-WiFi-B2

Benefits and Main Features:

- ⊕ Very easy to configure
- ⊕ 35mm Rail Din mount
- ⊕ Wide supply input range
- ⊕ Temperature range:
-40°C / 85°C (-40°F / 185°F)



For other Gateways / Bridges:

CAN from/to Modbus

See also the following links:

www.adfweb.com?product=HD67012

(Modbus RTU Slave)

www.adfweb.com?product=HD67514

(Modbus TCP Master)

www.adfweb.com?product=HD67515

(Modbus TCP Slave)

CANopen from/to Modbus

See also the following links:

www.adfweb.com?product=HD67001

(Modbus RTU Master)

www.adfweb.com?product=HD67502

(Modbus RTU Slave)

www.adfweb.com?product=HD67504

(Modbus TCP Master)

www.adfweb.com?product=HD67505

(Modbus TCP Slave)

Do you have an your customer protocol?

See the following links:

www.adfweb.com?Product=HD67003

Do you need to choose a device? do you want help?

Ask it to the following link:

www.adfweb.com?Cmd=helpme



User Manual

INDEX:

	Page
INDEX	2
UPDATED DOCUMENTATION	2
REVISION LIST	2
WARNING	2
TRADEMARKS	2
SECURITY ALERT	3
EXAMPLE OF CONNECTION	4
CONNECTION SCHEME	6
CHARACTERISTICS	9
CONFIGURATION	9
POWER SUPPLY	10
FUNCTIONS MODE	11
LEDS	12
ETHERNET (for HD67644-A1/B2)	14
WI-FI (for HD67644-WiFi-B2)	14
CAN	15
USE OF COMPOSITOR SW67644	17
NEW PROJECT / OPEN PROJECT	18
SOFTWARE OPTIONS	19
SET COMMUNICATION	21
RECEIVE COB	25
UPDATE DEVICE VIA UDP	26
ETHERNET PROTOCOL WITH TRANSPARENT MODE	28
ETHERNET PROTOCOL WITH SERVER MODE	33
MECHANICAL DIMENSIONS	36
ORDER CODE	39
ACCESSORIES	39
DISCLAIMER	40
OTHER REGULATIONS AND STANDARDS	40
WARRANTIES AND TECHNICAL SUPPORT	41
RETURN POLICY	41

UPDATED DOCUMENTATION:

Dear customer, we thank you for your attention and we remind you that you need to check that the following document is:

- ✦ Updated
- ✦ Related to the product you own

To obtain the most recently updated document, note the “document code” that appears at the top right-hand corner of each page of this document.

With this “Document Code” go to web page www.adfweb.com/download/ and search for the corresponding code on the page. Click on the proper “Document Code” and download the updates.

REVISION LIST:

Revision	Date	Author	Chapter	Description
1.000	04/11/2013	Ff	All	First release version
1.100	24/11/2014	Ff	All	New software version
1.101	15/12/2014	Ff	All	Added B2 version
1.200	04/12/2017	Ff	All	New Wi-Fi version

WARNING:

ADFweb.com reserves the right to change information in this manual about our product without warning.
ADFweb.com is not responsible for any error this manual may contain.

TRADEMARKS:

All trademarks mentioned in this document belong to their respective owners.

SECURITY ALERT:**GENERAL INFORMATION**

To ensure safe operation, the device must be operated according to the instructions in the manual. When using the device, legal and safety regulation are required for each individual application. The same applies also when using accessories.

INTENDED USE

Machines and systems must be designed so the faulty conditions do not lead to a dangerous situation for the operator (i.e. independent limit switches, mechanical interlocks, etc.).

QUALIFIED PERSONNEL

The device can be used only by qualified personnel, strictly in accordance with the specifications.

Qualified personnel are persons who are familiar with the installation, assembly, commissioning and operation of this equipment and who have appropriate qualifications for their job.

RESIDUAL RISKS

The device is state-of-the-art and is safe. The instruments can represent a potential hazard if they are inappropriately installed and operated by untrained personnel. These instructions refer to residual risks with the following symbol:



This symbol indicates that non-observance of the safety instructions is a danger for people that could lead to serious injury or death and / or the possibility of damage.

CE CONFORMITY

The declaration is made by our company. You can send an email to support@adfweb.com or give us a call if you need it.

EXAMPLE OF CONNECTION:

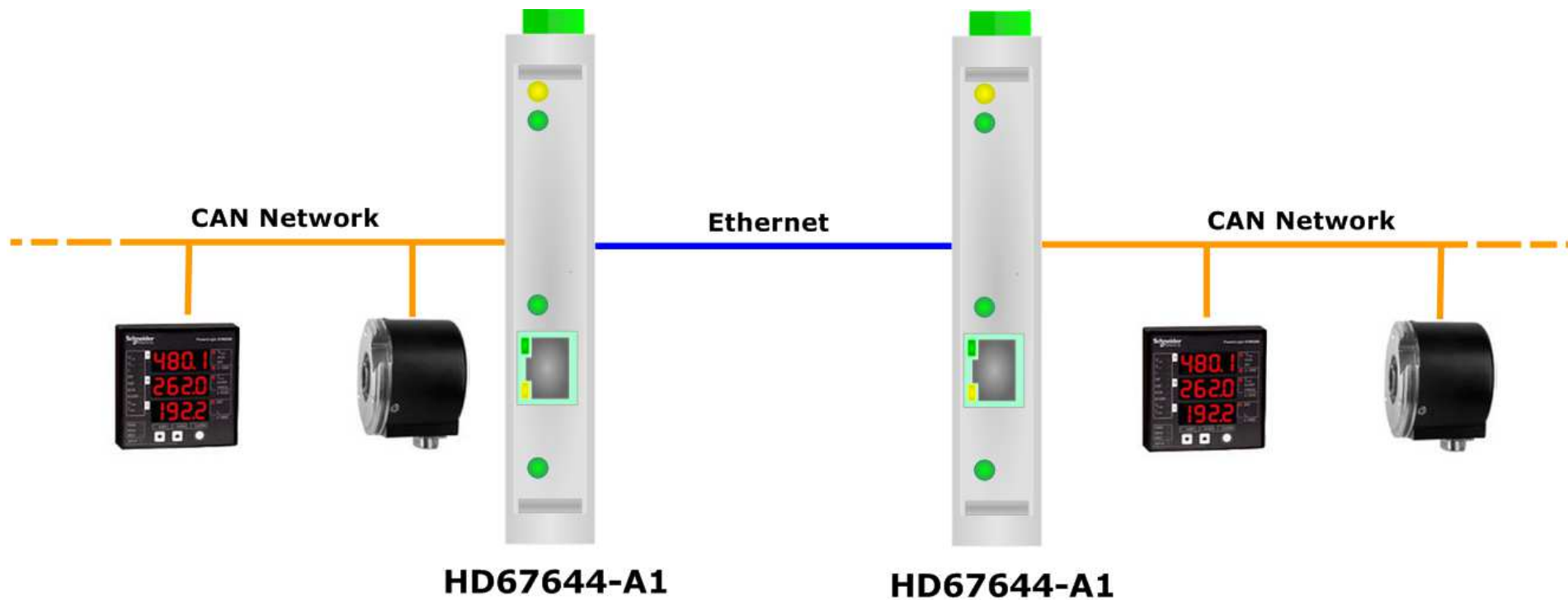

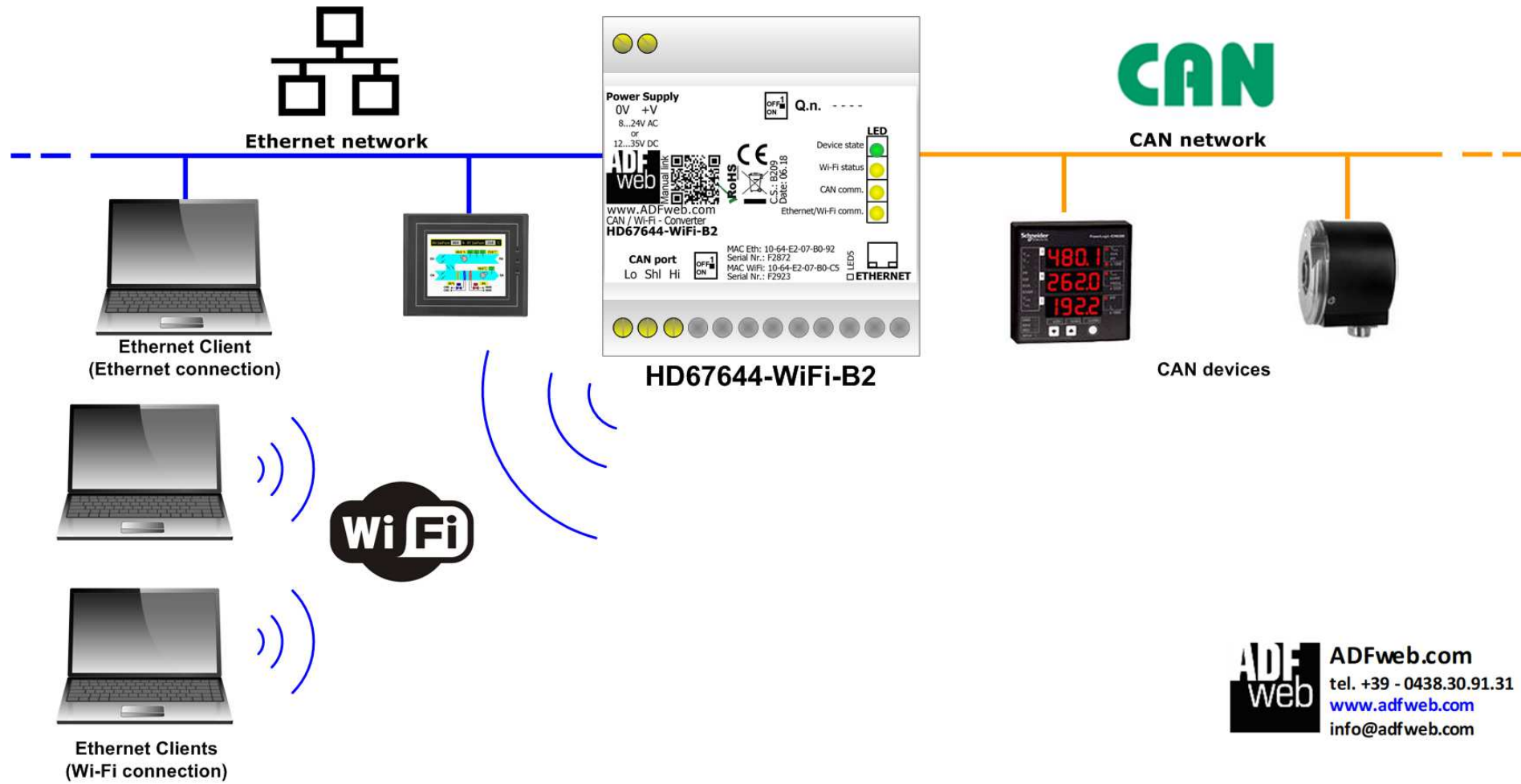

ADFweb **ADFweb.com**
 tel. +39 - 0438.30.91.31
www.adfweb.com
 info@adfweb.com

CONNECTION SCHEME:

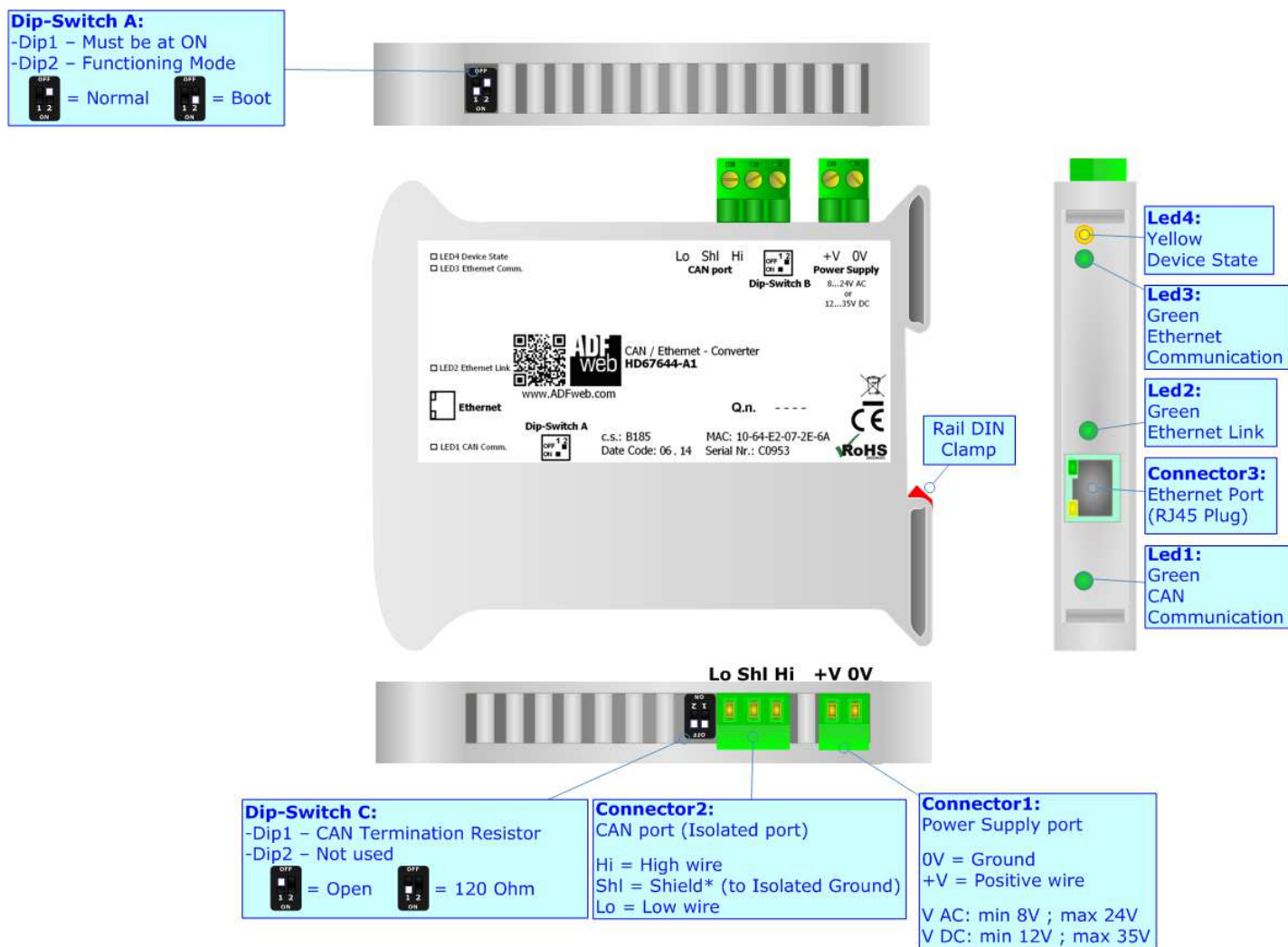

Figure 1a: Connection scheme for HD67644-A1

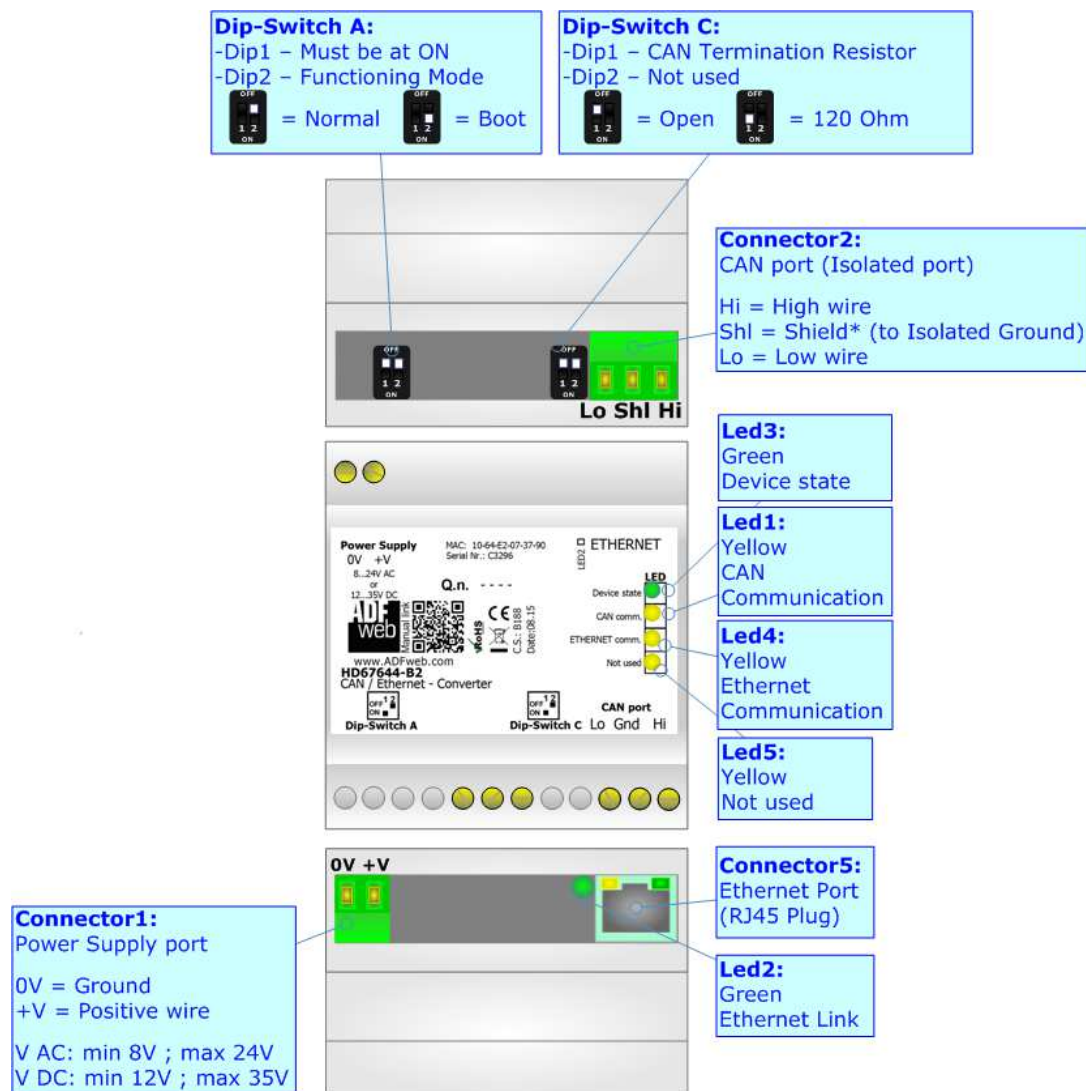

Figure 1b: Connection scheme for HD67644-B2

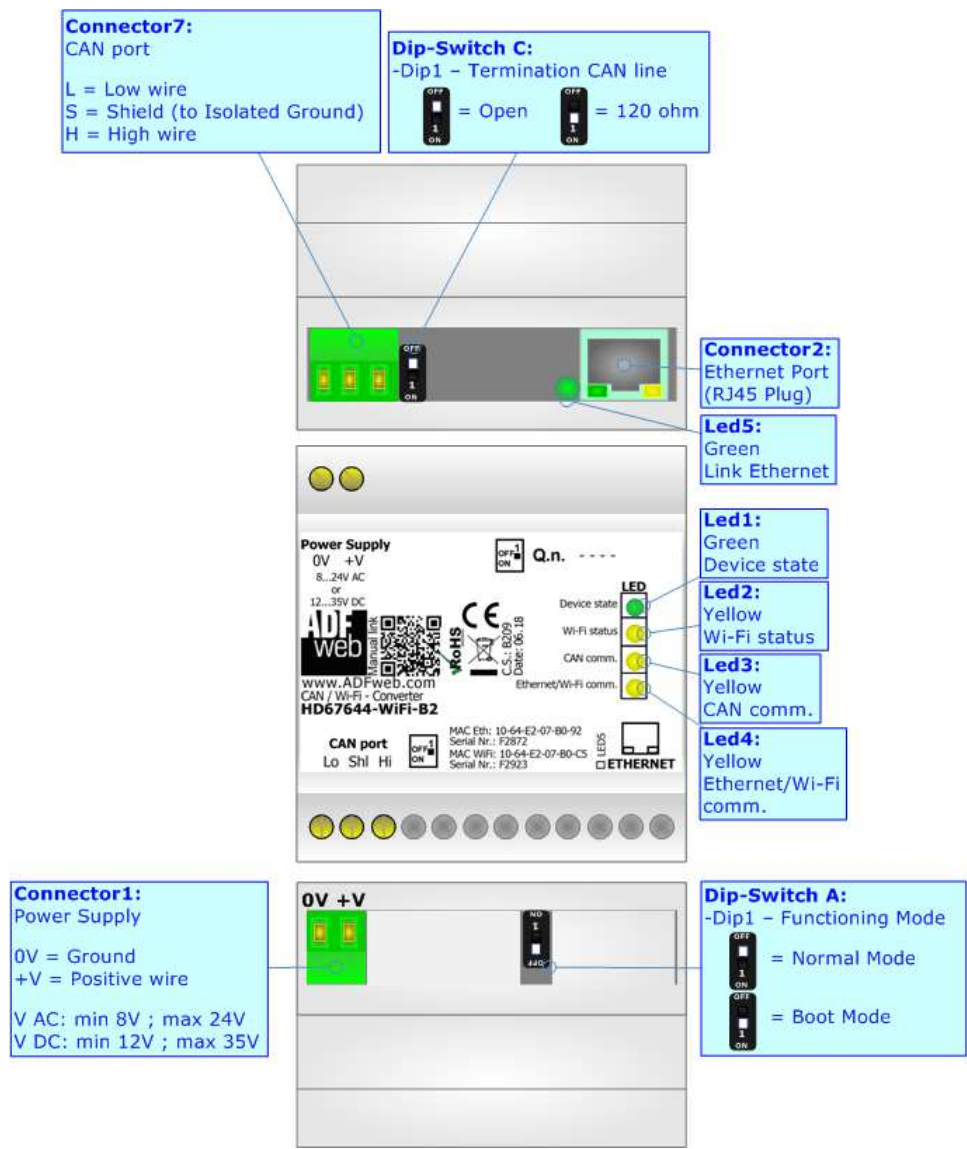

Figure 1c: Connection scheme for HD67644-WiFi-B2

CHARACTERISTICS:

The “**HD67644-A1/B2**” and the “**HD67644-WiFi-B2**” is a device used to interface CAN devices with Ethernet devices. This converter can be completely transparent at the CAN frame (so it allows to extend the CAN networks through Ethernet) or can allow the interface between CAN devices and Ethernet devices and vice versa, through a very simple Ethernet protocol. The function can be selected through software compositor.

The configurable converter allows the following characteristics:

- TCP/UDP Ethernet protocols changeable with software;
- Two-directional information between Ethernet/Wi-Fi and CAN bus;
- Electrical isolation between two buses;
- Power supply of 8...19 VAC or 8...35 VDC;
- 35mm Rail DIN mounting;
- Microprocessor for data control;
- Temperature range -40°C to 85°C.

CONFIGURATION:

You need Compositor SW67644 software on your PC in order to perform the following:

- Define the parameter of the CAN bus;
- Define the parameter of the Ethernet;
- Define the parameter of the Wi-Fi;
- Select the working mode (Server Mode or Transparent Mode);
- Define a list of Receive COB (if you use the Server Mode);
- Update the Firmware and/or the Project.

POWER SUPPLY:

The devices can be powered between a wide range of tensions. For more details see the two tables below.

VAC		VDC	
Vmin	Vmax	Vmin	Vmax
8V	24V	12V	35V

Consumption at 24V DC:

Device	W/VA
HD67644-A1/B2	4
HD67644-WiFi-B2	4

Warning: Not reverse the polarity power

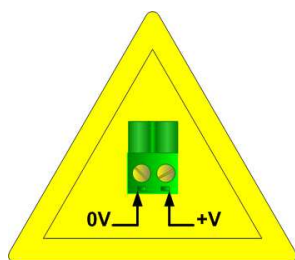

HD67644-A1

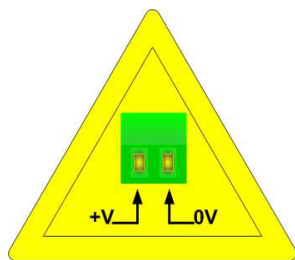

HD67644-B2
HD67644-WiFi-B2

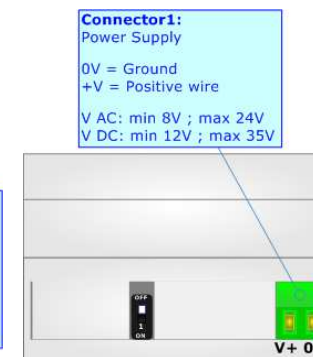
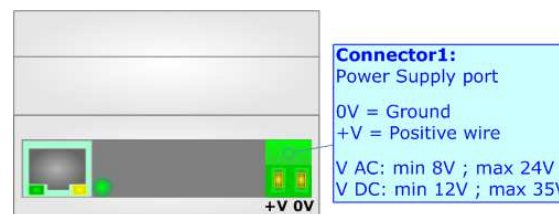

FUNCTION MODES:

The device has got two functions mode depending of the position of the 'Dip2 of Dip-Switch A':

- HD67644-A1/B2:
 - The first, with 'Dip2 of Dip-Switch A' at "OFF" position, is used for the normal working of the device.
 - The second, with 'Dip2 of Dip-Switch A' at "ON" position, is used for upload the Project and/or Firmware.
- HD67644-WiFi-B2:
 - The first, with 'Dip1 of Dip-Switch A' at "OFF" position, is used for the normal working of the device.
 - The second, with 'Dip 1 of Dip-Switch A' at "ON" position, is used for upload the Project and/or Firmware.

For the operations to follow for the updating, see 'UPDATE DEVICE' section.

According to the functioning mode, the LEDs will have specifics functions, see 'LEDS' section.

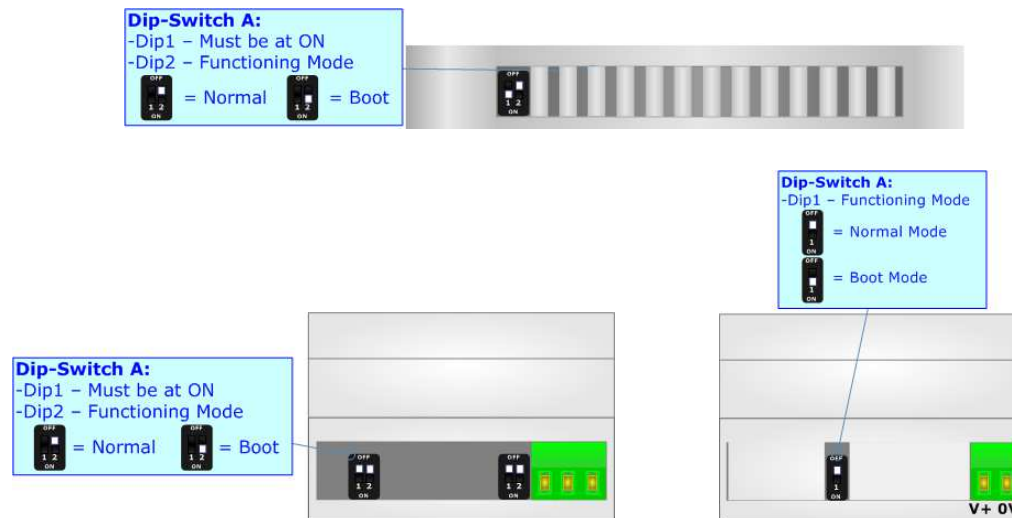

LEDS (HD67644-A1/B2):

The devices has got four LEDs that are used to give information of the functioning status. The various meanings of the LEDs are described in the table below.

LED	Normal Mode	Boot Mode
1: CAN Comm. (green)	Blinks quickly for a short time when CAN frame is received	Blinks quickly: Boot state Blinks very slowly (~0.5Hz): update in progress
2: Ethernet Link (green)	On: Ethernet cable connected Off: Ethernet cable disconnected	Blinks quickly: Boot state Blinks very slowly (~0.5Hz): update in progress
3: Ethernet Comm. (green)	Blinks quickly for a short time when an Ethernet frame is received	Blinks quickly: Boot state Blinks very slowly (~0.5Hz): update in progress
4: Device State (yellow)	Blinks slowly (~1Hz)	Blinks quickly: Boot state Blinks very slowly (~0.5Hz): update in progress

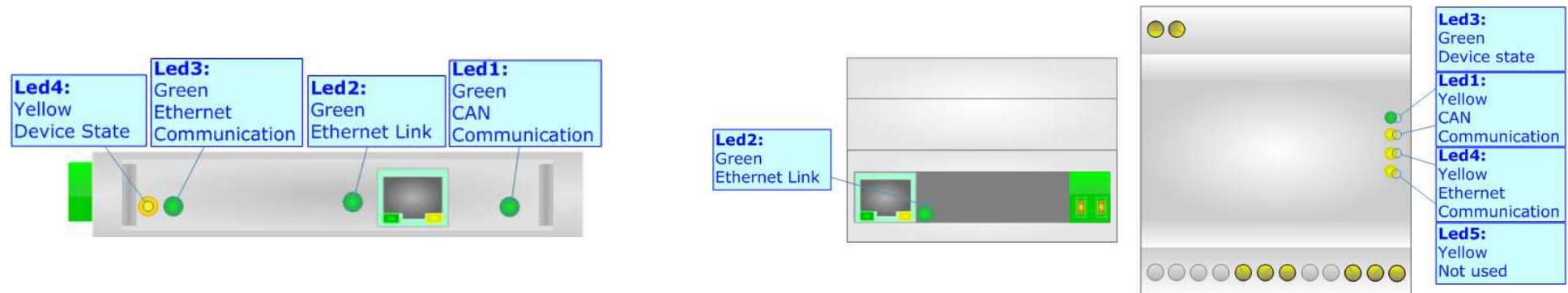

LEDS (HD67644-WiFi-B2):

The devices has got five LEDs that are used to give information of the functioning status.
 The various meanings of the LEDs are described in the table below.

LED	Normal Mode	Boot Mode
1: Device state (green)	Blinks slowly (~1Hz)	Blinks quickly: Boot state Blinks very slowly (~0.5Hz): update in progress
2: Wi-Fi status (yellow)	ON: Wi-Fi is being initialized OFF: Wi-Fi is running	Blinks quickly: Boot state Blinks very slowly (~0.5Hz): update in progress
3: CAN comm. (yellow)	Blinks when CAN frames are received	Blinks quickly: Boot state Blinks very slowly (~0.5Hz): update in progress
4: Ethernet comm. (yellow)	Blinks when Ethernet frames (Ethernet or Wi-Fi) are received	Blinks quickly: Boot state Blinks very slowly (~0.5Hz): update in progress
2: Ethernet Link (green)	ON: Ethernet cable connected OFF: Ethernet cable disconnected	ON: Ethernet cable connected OFF: Ethernet cable disconnected

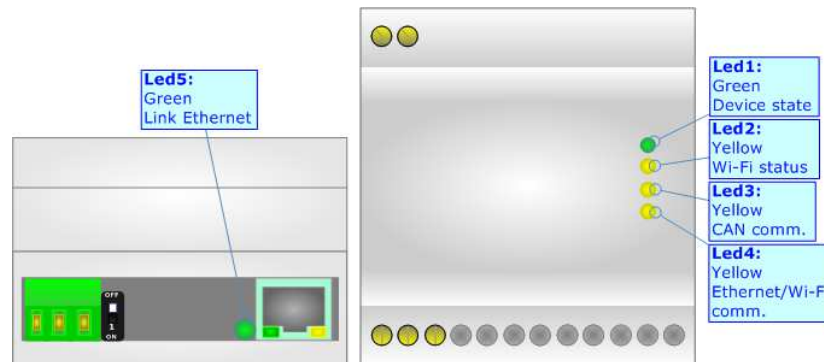

ETHERNET:

The Ethernet connection must be made using Connector5 of HD67644-A1/B2 with at least a Category 5E cable. The maximum length of the cable should not exceed 100m. The cable has to conform to the T568 norms relative to connections in cat.5 up to 100 Mbps. To connect the device to a Hub/Switch the use of a straight cable is recommended. To connect the device to a PC/PLC/other the use of a cross cable is recommended.

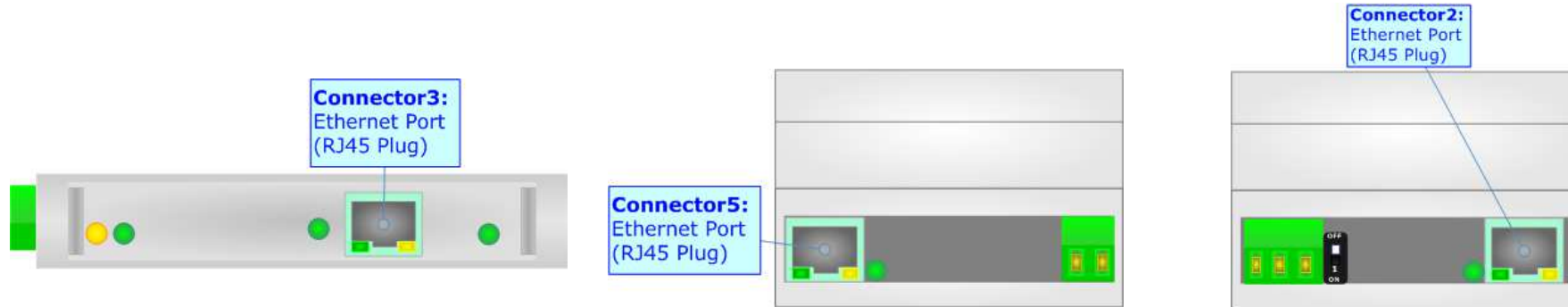

Wi-Fi (for HD67644-WiFi-B2):

The HD67644-WiFi-B2 can be configured as Wi-Fi Access Point or Wi-Fi Client. It supports DHCP functions. The type of Wi-Fi used is the 802.11b/g/n and it supports different type of security protocol: WEP, WPA, WPA2 and none. The antenna is integrated in the hardware, so any external antenna is ned.

CAN:

For terminating the CAN line with a 120Ω resistor it is necessary that the Dip1 of 'Dip-Switch B/C' is at ON position.

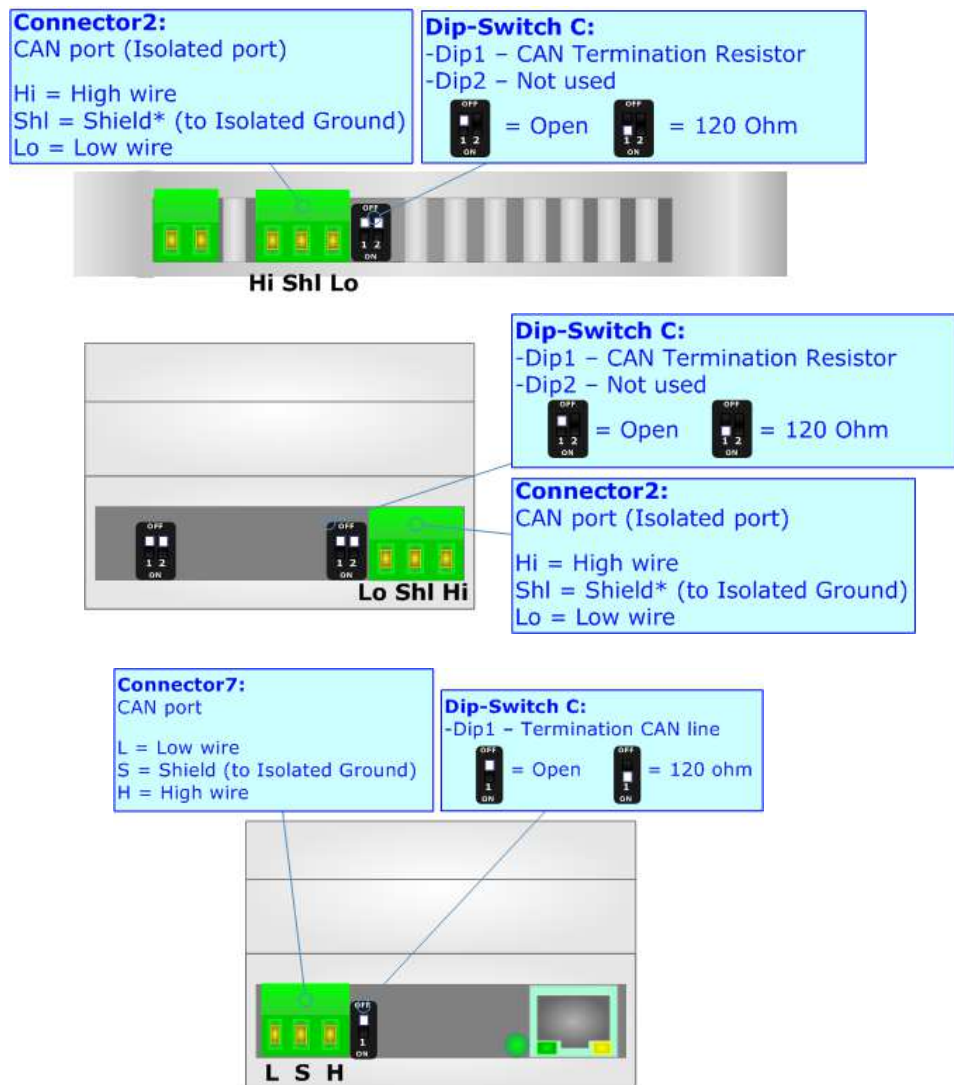

Cable characteristics:

DC parameter:		Impedance	70 Ohm/m
AC parameters:		Impedance	120 Ohm/m
		Delay	5 ns/m
Length		Baud Rate [bps]	Length MAX [m]
		10 K	5000
		20 K	2500
		50 K	1000
		100 K	650
		125 K	500
		250 K	250
		500 K	100
		800 K	50
		1000 K	25

USE OF COMPOSITOR SW67644:

To configure the Converter, use the available software that runs with Windows called SW67644. It is downloadable on the site www.adfweb.com and its operation is described in this document. *(This manual is referenced to the last version of the software present on our web site).* The software works with MSWindows (XP, Vista, Seven, 8, 10; 32/64bit).

When launching the SW67644, the window below appears (Fig. 2).

 **Note:**
It is necessary to have installed .Net Framework 4.



Figure 2: Main window for SW67644

NEW CONFIGURATION / OPEN CONFIGURATION:

The “**New Configuration**” button creates the folder which contains the entire device’s configuration.

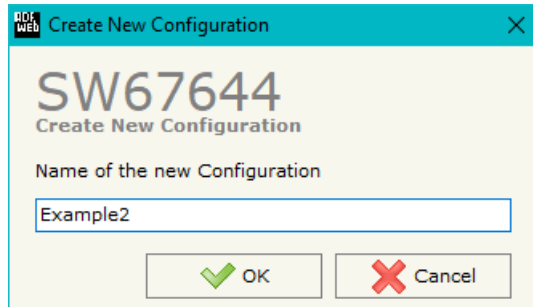

A device’s configuration can also be imported or exported:

- To clone the configurations of a programmable “Ethernet / CAN - Converter” in order to configure another device in the same manner, it is necessary to maintain the folder and all its contents;
- To clone a project in order to obtain a different version of the project, it is sufficient to duplicate the project folder with another name and open the new folder with the button “**Open Configuration**”.

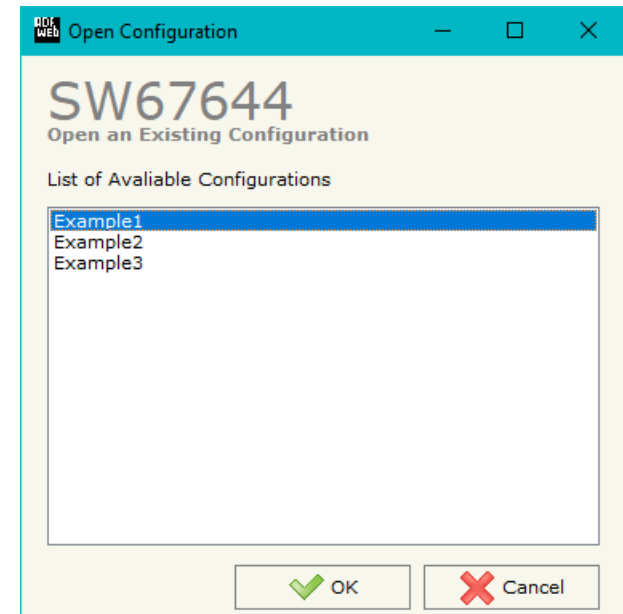

SOFTWARE OPTIONS:

By pressing the “**Settings**” () button there is the possibility to change the language of the software and check the updatings for the compositor.

In the section “Language” it is possible to change the language of the software.

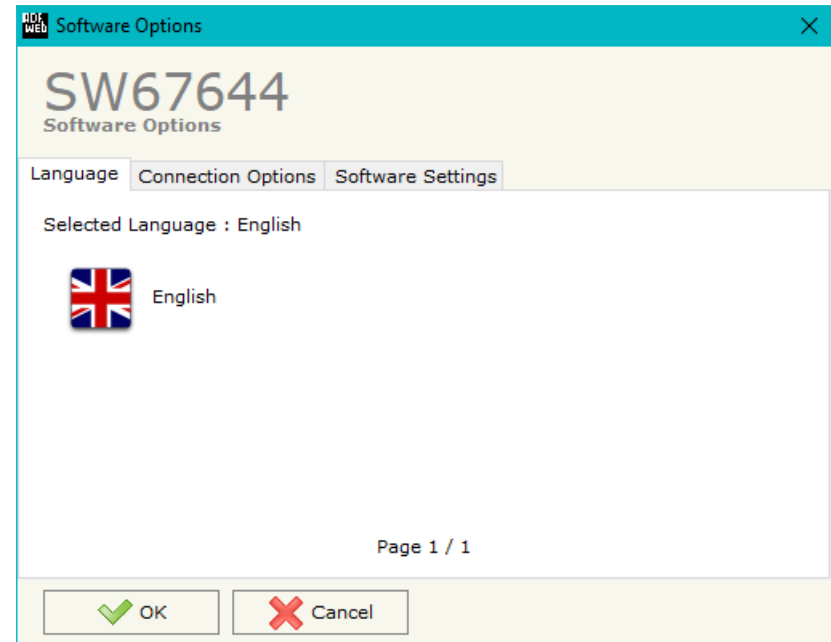
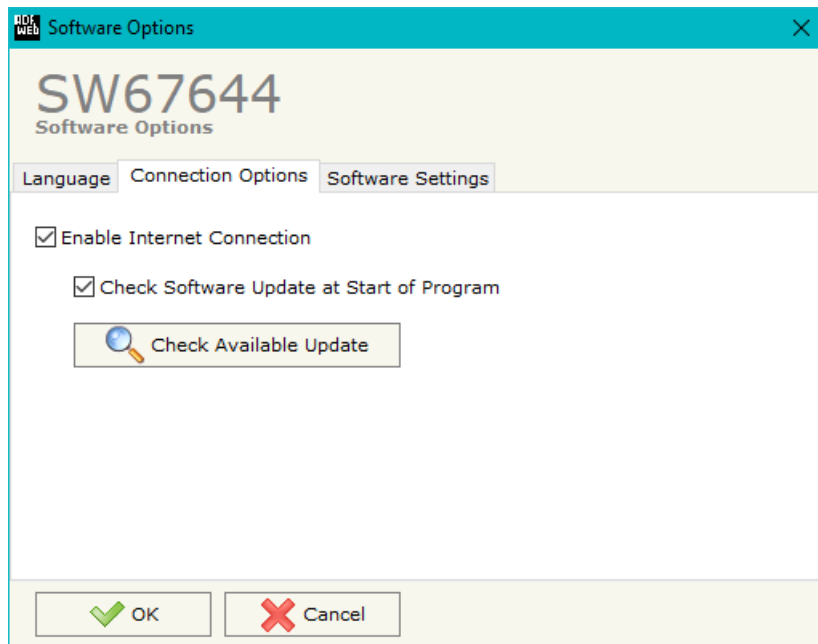

In the section “Connection Options”, it is possible to check if there are some updatings of the software compositor in ADFweb.com website. Checking the option “**Check Software Update at Start of Program**”, the SW67644 check automatically if there are updatings when it is launched.

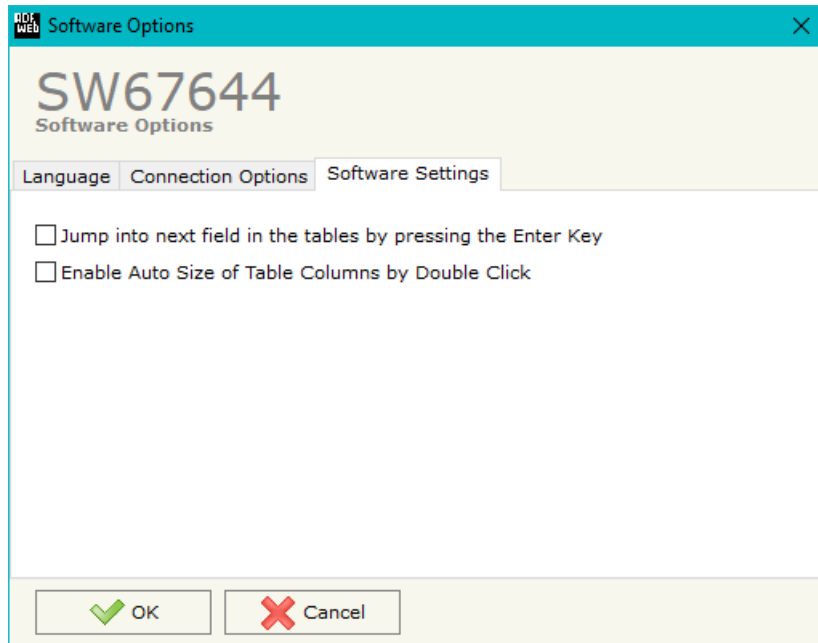

In the section "Software Settings", it is possible to enable/disable some keyboard's commands for an easier navigation inside the tables contained in the different sections of the software.

SET COMMUNICATION:

By Pressing the "**Set Communication**" button from the main window for SW67644 (Fig. 2) the window "Set Communication" appears (Fig. 3).

The window is divided in different sections in order to define the different parameters of the converter:

- Select Device
- Working Mode
- CAN
- Ethernet
- Wi-Fi

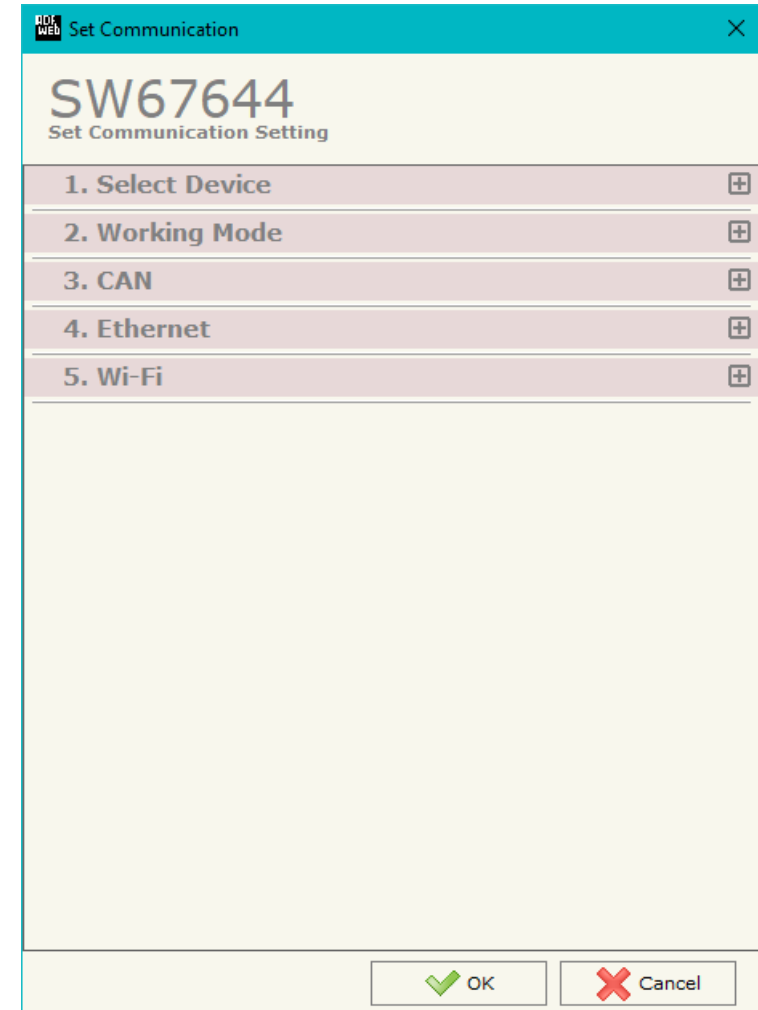

Figure 3a: "Set Communication" window

SELECT DEVICE:

This section is used to select the converter in use:

- HD67644-A1 / B2
- HD67644-WiFi-B2

WORKING MODE:

This section is used to define the working mode of the converter. It is possible to define:

- In the field "**Working Mode**" the working mode of the converter is defined:
 - **Transparent Mode**: the converter will send on Ethernet all the packets received from CAN and vice versa using the simple Ethernet protocol implemented.
 - **Server Mode**: it is possible to read the data of only some COB-IDs from CAN (defined in the section "Receive COB", see page XX) and write some CAN frames.
- In the field "**Protocol**" the protocol used on Ethernet side is defined (TCP or UDP);
- If the field "**Enable Multiframe in Ethernet**" is checked the Gateway can send or receive in a single Ethernet frame more CAN frames. A single Ethernet frame can contain up to twenty CAN frames or the CAN frames that arrive within 5 ms after the first. Otherwise a single CAN frame is put in an Ethernet frame and sent.
- If the field "**Type**", it is defined if the gateway works like client TCP and/or server TCP (only if TCP option is checked);
- If the "**UDP Broadcast**" field is checked the gateway send the UDP packet in broadcast on the network (only if UDP option is selected).

CAN

This section is used to define the main parameters of Modbus line. The means of the fields are:

- In the field "**Baudrate**" the baudrate for the CAN line is defined;

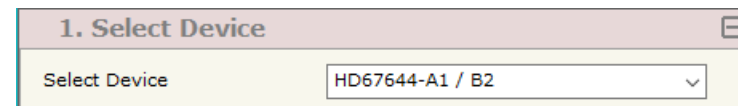

Figure 3b: "Set Communication → Select Device" window

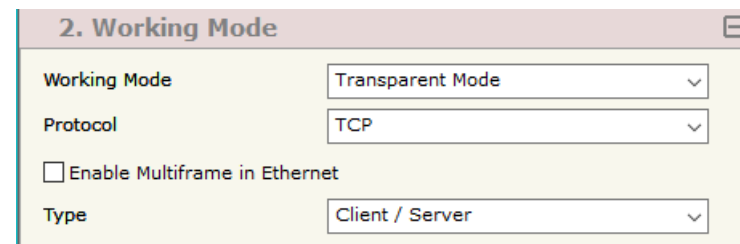

Figure 3c: "Set Communication → Working Mode" window

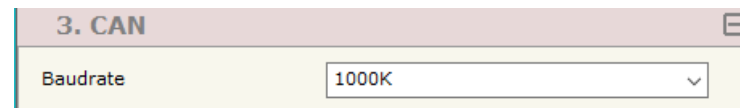

Figure 3d: "Set Communication → CAN" window

ETHERNET:

This section is used to define the general parameters of Ethernet. The means of the fields are:

- In the field "**Ip Address**" the IP address of the converter is defined;
- In the field "**SubNet Mask**" the Subnet Mask of the converter is defined;
- In the field "**Gateway**" the default gateway of the net is defined. This feature can be enabled or disabled pressing the Check Box field. This feature is used for going out of the net;
- In the field "**Destination IP Address**" the IP address of Ethernet device to which addressing the messages is defined (only for Transparent Mode);
- In the field "**Port**" the port for Ethernet communication is defined.

WI-FI:

This section is used to define the general parameters of Wi-Fi. It is possible to defined the type of Wi-Fi communication:

- Access Point;
- Client.

The means of the fields for Access Point configuration are:

- In the field "**IP Address**" the IP address of the converter is defined;
- In the field "**Subnet Mask**" the SubNet Mask of the converter is defined;
- In the field "**GATEWAY**" the default gateway of the net is defined. This feature can be enabled or disabled pressing the Check Box field. This feature is used for going out of the net;
- In the field "**DNS**" the DNS address is defined.
- In the field "**Port**" the port used for Ethernet communication is defined;
- In the field "**SSID**" the name of the Wi-Fi network to create is defined;
- In the field "**Password**" the password used for Wi-Fi connection is defined;

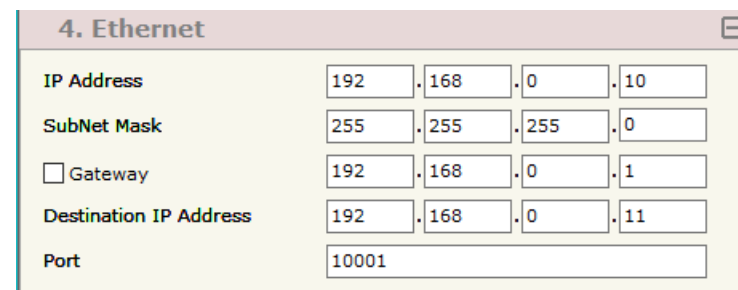

4. Ethernet				
IP Address	192	.168	.0	.10
SubNet Mask	255	.255	.255	.0
<input checked="" type="checkbox"/> Gateway	192	.168	.0	.1
Destination IP Address	192	.168	.0	.11
Port	10001			

Figure 3e: "Set Communication → Ethernet" window

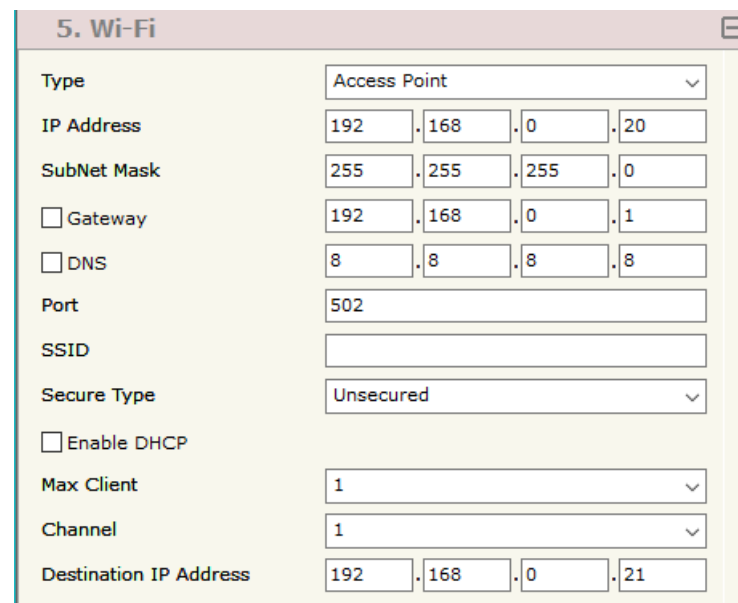

5. Wi-Fi				
Type	Access Point			
IP Address	192	.168	.0	.20
SubNet Mask	255	.255	.255	.0
<input checked="" type="checkbox"/> Gateway	192	.168	.0	.1
<input checked="" type="checkbox"/> DNS	8	.8	.8	.8
Port	502			
SSID				
Secure Type	Unsecured			
<input type="checkbox"/> Enable DHCP				
Max Client	1			
Channel	1			
Destination IP Address	192	.168	.0	.21

Figure 3f: "Set Communication → Wi-Fi" window

- In the field "**Secure Type**" the type of security protocol used by the Wi-Fi network is defined;
- If the field "**Enable DHCP**" is checked, the converter acts as DHCP Server for the Clients connected. If the option is enabled, in the fields "**DHCP First IP Address**" and "**DHCP SUBNET Mask**" the IP Addresses range used for DHCP is defined. In the field "**Lease Time (seconds)**" the required time for the renewing of the IP Address assigned to the Client is defined;
- In the field "**Max Client**" the maximum number of Wi-Fi Clients accepted is defined;
- In the field "**Channel**" the channel for Wi-Fi communication is defined;
- In the field "**Destination IP Address**" the IP address of Ethernet device to which addressing the messages is defined (only for Transparent Mode).

The means of the fields for Client configuration are:

- If the field "**Obtain an IP Address automatically**" is checked, the converter gets the IP Address using DHCP. Otherwise, the IP Address is defined as static;
- In the field "**IP Address**" the IP address of the converter is defined;
- In the field "**Subnet Mask**" the SubNet Mask of the converter is defined;
- In the field "**GATEWAY**" the default gateway of the net is defined. This feature can be enabled or disabled pressing the Check Box field. This feature is used for going out of the net;
- In the field "**DNS**" the DNS address is defined. This field is required if the server address is define by URL and not IP Address.
- In the field "**Port**" the port used for Ethernet communication is defined;
- In the field "**SSID**" the name of the Wi-Fi network to connect is defined;
- In the field "**Password**" the password used to connect to the Wi-Fi network is defined;
- In the field "**Destination IP Address**" the IP address of Ethernet device to which addressing the messages is defined (only for Transparent Mode).

5. Wi-Fi				
Type	Client Mode			
<input type="checkbox"/> Obtain an IP Address automatically				
IP Address	192	168	0	20
SubNet Mask	255	255	255	0
<input type="checkbox"/> Gateway	192	168	0	1
<input type="checkbox"/> DNS	8	8	8	8
Port	502			
SSID				
Password				
Destination IP Address	192	168	0	21

Figure 3g: "Set Communication → Wi-Fi" window

RECEIVE COB:

If the "Server Mode" is selected, by pressing the "Receive COB" button from the main window for SW67644 (Fig. 2) the window "Receive CAN Frame" appears (Fig. 4).

If the "Transparent Mode" is selected, this button is disabled.

The means of the fields are:

- In the field "Cob-ID", the Cob-ID of the CAN frame is defined;
- In the field "Cob-ID Type", the CAN Protocol of the frame (CAN2.0A or CAN 2.0B) is defined;
- If the field "TimeOut (ms)" the TimeOut is defined; after the TimeOut defined, the value of the data of the CAN message become "0" if the field "Cancel Data" is enabled;
- In the field "Mnemonic", a brief description is defined.

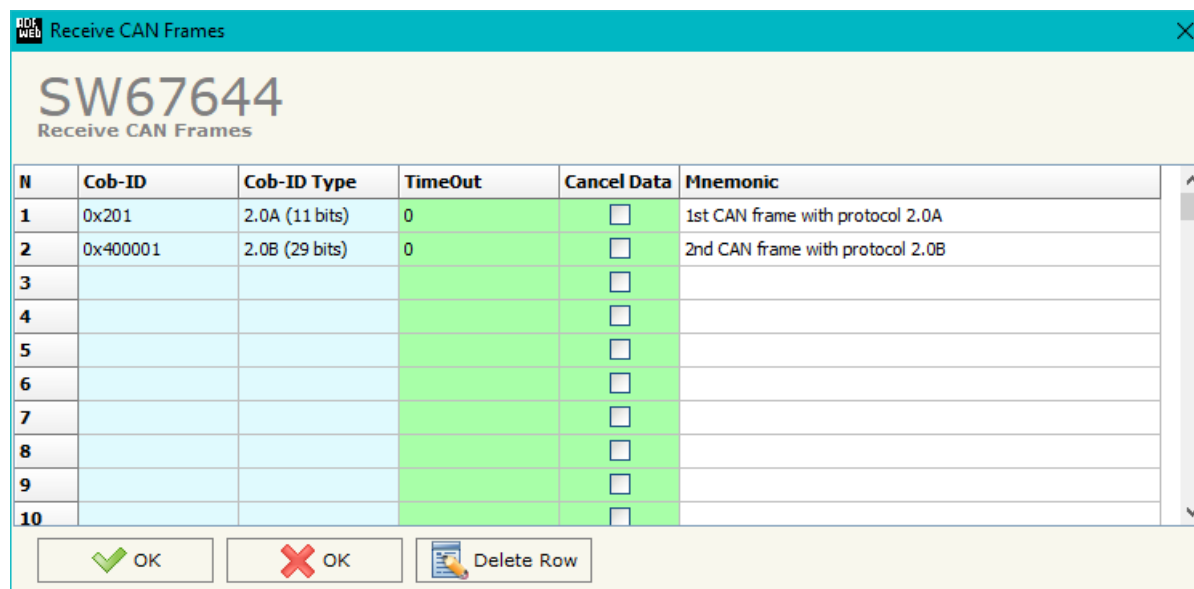

N	Cob-ID	Cob-ID Type	TimeOut	Cancel Data	Mnemonic
1	0x201	2.0A (11 bits)	0	<input type="checkbox"/>	1st CAN frame with protocol 2.0A
2	0x400001	2.0B (29 bits)	0	<input type="checkbox"/>	2nd CAN frame with protocol 2.0B
3				<input type="checkbox"/>	
4				<input type="checkbox"/>	
5				<input type="checkbox"/>	
6				<input type="checkbox"/>	
7				<input type="checkbox"/>	
8				<input type="checkbox"/>	
9				<input type="checkbox"/>	
10				<input type="checkbox"/>	

Figure 4: "Receive CAN Frame" window

UPDATE DEVICE VIA UDP:

By pressing the “**Update Device**” button, it is possible to load the created Configuration into the device; and also the Firmware, if necessary.

If you don’t know the actual IP address of the device you have to use this procedure:

- Turn OFF the Device;
- Put Dip2 of ‘Dip-Switch A’ in ON position;
- Turn ON the device
- Connect the Ethernet cable;
- Insert the IP “**192.168.2.205**”;
- Press the “**Ping**” button, “Device Found! must appear”;
- Press the “**Next**” button;
- Select which operations you want to do;
- Press the “**Execute update firmware**” button to start the upload;
- When all the operations are “OK” turn OFF the Device;
- Put Dip2 of ‘Dip-Switch A’ in OFF position;
- Turn ON the device.

If you know the actual IP address of the device, you have to use this procedure:

- Turn on the Device with the Ethernet cable inserted;
- Insert the actual IP of the Converter;
- Press the “**Ping**” button, must appear “Device Found!”;
- Press the “**Next**” button;
- Select which operations you want to do;
- Press the “**Execute update firmware**” button to start the upload;
- When all the operations are “OK” the device automatically goes at Normal Mode.

At this point the configuration/firmware on the device is correctly updated.

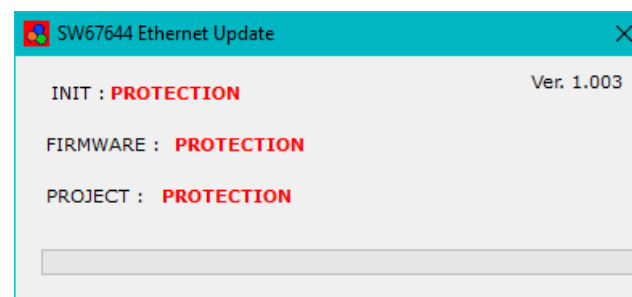
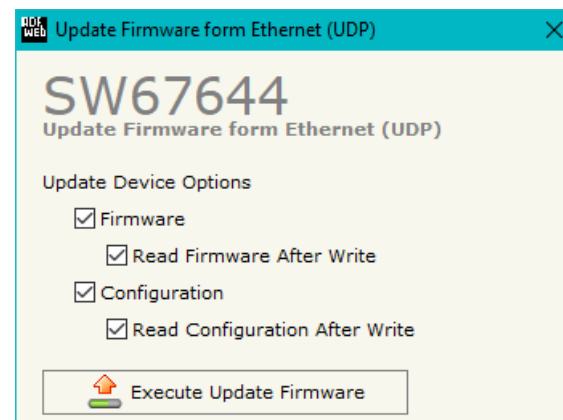
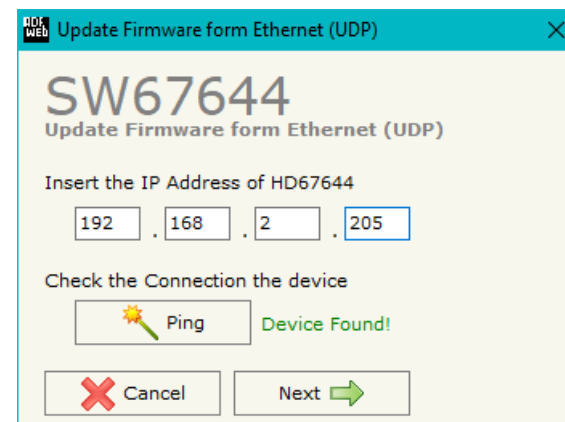

Figure 5: “Update via UDP” windows

**Note:**

When you install a new version of the software, if it is the first time it is better you do the update of the Firmware in the HD67644 device.

**Note:**

When you receive the device, for the first time, you also have to update the Firmware in the HD67644 device.

**Warning:**

If Fig. 6 appears when you try to do the Update try these points before seeking assistance:

- Try to repeat the operations for the updating;
- Try with another PC;
- Try to restart the PC;
- Check the LAN settings;
- Check the Wi-Fi settings;
- If you are using the program inside a Virtual Machine, try to use in the main Operating System;
- If you are using Windows Seven, Vista, 8 or 10 make sure that you have the administrator privileges;
- In case you have to program more than one device, using the "UDP Update", you have to cancel the ARP table every time you connect a new device on Ethernet. For do this you have to launch the "Command Prompt" and write the command "arp -d". Pay attention that with Windows Vista, Seven, 8 you have to launch the "Command Prompt" with Administrator Rights;
- Pay attention at Firewall lock.

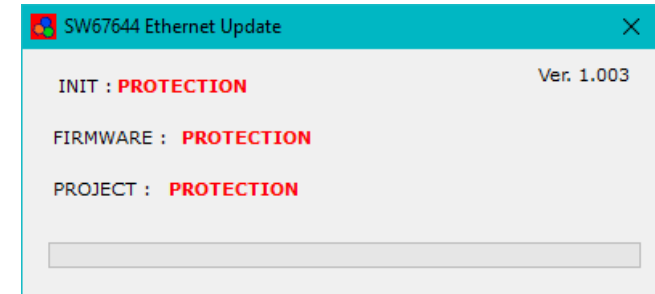

Figure 6: "Protection" window

In the case of HD67644 you have to use the software "SW67644": www.adfweb.com/download/filefold/SW67644.zip.

ETHERNET PROTOCOL WITH TRANSPARENT MODE

ETHERNET FRAME TO BE SENT TO OUR GATEWAY WITH "ENABLE MULTIFRAME IN ETHERNET" DISABLED

The Bytes that compose the frame are these:

Byte Number	Description
1 ÷ 4	Cob_ID
5 ÷ 12	Data (Byte 5 is the higher, byte 12 is the lower)
13	Number of Byte to send (0x00÷0x08)

To choose the type of CAN (2.0A or 2.0B) of the frame that the converter will send, it is necessary to put the most significant bit of the byte 1 to:

- 0: CAN 2.0A;
- 1: CAN 2.0B.

If the "Number of Byte to send" has got a value less than 0x08 the byte of Data unused must be put with value 0x00.

Example:

We want to write in CAN network a frame with the following characteristics: CAN Type=2.0B; Cob_ID=0x01FECA02; Data=0x0123456789AB0000; Number of Byte to send=6.

So the string of hexadecimal numbers to be send to our Gateway is: [81][FE][CA][02][01][23][45][67][89][AB][00][00][06]

ETHERNET FRAME TO BE SENT TO OUR GATEWAY WITH "ENABLE MULTIFRAME IN ETHERNET" ENABLED

The Bytes that compose the frame are these:

Byte Number	Description
1	Number of CAN frames in Ethernet frame
2 ÷ 5	Cob_ID
6 ÷ 13	Data (Byte 6 is the higher, byte 13 is the lower)
14	Number of Byte to send (0x00÷0x08)

If the "Enable Multiframe in Ethernet" field is checked the first byte of the frame contain the numbers of CAN frames to be sent in CAN network. If this byte is bigger than one, the bytes 2÷14 are repeated for every CAN frame. If the "Number of Byte to send" has got a value less than 0x08 the byte of Data unused must be put with value 0x00. A single Ethernet frame can contain up to 20 CAN frames or the frames that arrived within 5 ms after the first.

To choose the type of CAN (2.0A or 2.0B) of the frame that the converter will send, it is necessary to put the most significant bit of the byte 2 to:

- 0: CAN 2.0A;
- 1: CAN 2.0B.

Example:

We want to write in CAN network two frames with the following characteristics:

- CAN Type=2.0B; Frame 1: Cob_ID=0x01FECA02; Data=0x0123456789ABCDEF; Number of Byte to send=8;
- CAN Type=2.0B; Frame 2: Cob_ID=0x01FEBA04; Data=0x0102030405060000; Number of Byte to send=6.

So the string of hexadecimal numbers to be send to our Gateway is:

[02][81][FE][CA][02][01][23][45][67][89][AB][CD][EF][08][01][FE][BA][04][01][02][03][04][05][06][00][00][06]

ETHERNET FRAME THAT CONTAIN CAN FRAMES ARRIVED IN THE GATEWAY WITH "ENABLE MULTIFRAME IN ETHERNET" DISABLED

The Bytes that compose the frame are these:

Byte Number	Description
1÷4	Cob_ID
5÷12	Data (Byte 5 is the higher, byte 12 is the lower)
13	Number of Data Byte (0x00÷0x08)

To define the type of CAN (2.0A or 2.0B) of the frame that the converter has received, it is necessary to read the most significant bit of the byte 1:

- 0: CAN 2.0A;
- 1: CAN 2.0B.

If the "Number of Data Byte" has got a value less than 0x08 the byte of Data unused have the value 0x00.

Example:

The Gateway receives a CAN frame with the following characteristics: CAN Type=2.0B; Cob_ID=0x01FECA02; Data=0x0123456789AB; Number of Data Byte=6.

So the string of hexadecimal numbers that we send in Ethernet is: [81][FE][CA][02][01][23][45][67][89][AB][00][00][06]

ETHERNET FRAME THAT CONTAIN CAN FRAMES ARRIVED IN THE GATEWAY WITH "ENABLE MULTIFRAME IN ETHERNET" ENABLED

The Bytes that compose the frame are these:

Byte Number	Description
1	Number of CAN frames in Ethernet frame
2÷5	Cob_ID
6÷13	Data (Byte 6 is the higher, byte 13 is the lower)
14	Number of Data Byte (0x00÷0x08)

If the "Enable Multiframe in Ethernet" field is checked the first byte of the frame contain the numbers of CAN frames to be sent in CAN network. If this byte is bigger than one, the bytes 2÷14 are repeated for every CAN frame. If the "Number of Data Byte" has got a value less than 0x08 the byte of Data unused has the value 0x00. A single Ethernet frame can contain up to 20 CAN frames or the frames that arrived within 5 ms after the first.

To define the type of CAN (2.0A or 2.0B) of the frame that the converter has received, it is necessary to read the most significant bit of the COB-ID's bytes:

- 0: CAN 2.0A;
- 1: CAN 2.0B.

Example:

The Gateway receives two CAN frames with the following characteristics:

- Frame 1: CAN Type=2.0B; Cob_ID=0x01FECA02; Data=0x0123456789ABCDEF; Number of Byte to send=8;
- Frame 2: CAN Type=2.0B; Cob_ID=0x01FEBA04; Data=0x010203040506; Number of Byte to send=6.

So the string of hexadecimal numbers that we send in Ethernet is:

[02][81][FE][CA][02][01][23][45][67][89][AB][CD][EF][08][01][FE][BA][04][01][02][03][04][05][06][00][00][06]

REMOTE TRANSMIT REQUEST (RTR) FRAME

It is possible to send or receive Remote Frames. For doing that it is necessary to use the fifth bit of the field "Number of Byte to send" if you want to send a CAN frame to the network from Ethernet, and also in the Ethernet frame sent by the gateway when a CAN frame arrives the field "Number of Data Byte" contain in the fifth bit the information of the Remote Frame.

If this bit is at 1 means that the frame is a Remote Frame, otherwise, if is at 0, means that is a normal frame.

To define the type of CAN (2.0A or 2.0B), it is necessary to read the most significant bit of the COB-ID's bytes. If this bit is 0, it means that it is CAN 2.0A, if this bit is 1, it is CAN 2.0B.

Examples:

- 1) We want to write in CAN network a frame with the following characteristics: CAN Type=2.0A; Cob_ID=0x201; RTR bit active.
So the string of hexadecimal numbers to be send to our Gateway is: [00][00][02][01][00][00][00][00][00][00][00][10]
- 2) The Gateway receives a two CAN frames with the following characteristics:
Frame 1: CAN Type=2.0B; Cob_ID=0x01FECA02; Data=0x0123456789ABCDEF; Number of Byte to send=8;
Frame 2: CAN Type=2.0B; Cob_ID=0x01FEBA04; RTR bit active.

So the string of hexadecimal numbers that we send in Ethernet is:

[02][81][FE][CA][02][01][23][45][67][89][AB][CD][EF][08][81][FE][BA][04][00][00][00][00][00][00][00][00][10]

ETHERNET PROTOCOL WITH SERVER MODE

This protocol is able to read and write frames in the CAN net.

Write Frames

The transmission is very simple; it requires only what are the packets to send. In a single request it is possible to write at maximum 19 frames in the CAN net. The Bytes that composed the request are these:

Byte Number	Description
1	Write Identifier (0x02)
2	Number of frames to send
3÷6	Cob_ID
7	Number of Byte to send (0x01÷0x08)
8÷15	Data (Byte 8 is the higher, byte 15 is the lower)

A single frame is composed by 13 bytes (byte 3 to byte 15). If the "Number of frame to send" (Byte Number 2) has got a value greater than zero, the next frame is composed from byte 3 to byte 15 and so for all the frames.

If the "Number of Byte to send" has got a value less than 0x08 the byte of Data unused must be put with value 0x00.

To choose the type of CAN (2.0A or 2.0B) of the frame that the converter will send, it is necessary to put the most significant bit of the byte 3 to:

- 0: CAN 2.0A;
- 1: CAN 2.0B.

The response is composed only by one byte. It can have two values:

- 0x00: No Errors;
- 0x01: Parameter Error.

Example:

We want to write three frames with the following characteristics:

Frame 1: CAN Type=2.0A; Cob_ID=0x0000018A; Number of Byte to send=8; Data=0x0102030405060708;

Frame 2: CAN Type=2.0B; Cob_ID=0x000413CB; Number of Byte to send=6; Data=0x1122334455660000;

Frame 3: CAN Type=2.0A; Cob_ID=0x00000001; Number of Byte to send=8; Data=0x123456789A9B9C9D.



So the string of hexadecimal numbers is:

REQ:[02][03][00][00][01][8A][08][01][02][03][04][05][06][07][08][80][04][13][CB][06][11][22][33][44][55][66][00][00][00][00][00][01][08][12][34][56][78][9A][9B][9C][9D]
RES:[00]

Read Frames

For reading Data it is necessary to have a map in the RAM memory that contains the Data that passing in the bus. This map is implemented in the "Compositor SW67644" but it has some standard addresses given by the software. It is possible to see this map in Fig. 6.

The Bytes that composed the request are these:

Byte Number	Description
1	Read Identifier (0x01)
2	Starting Address Hi
3	Starting Address Lo
4	Number of Byte to read Hi
5	Number of Byte to read Lo

The Bytes that composed the respons are these:

Byte Number	Description
1	Error
2÷n+1	Data

n=Number of Byte

The Error Byte (Byte 1) can have three values:

- 0x00: No error;
- 0x01: Starting Address doesn't exist;
- 0x02: Too many Data to read.

Example:

1- We want to read the data of the first COB-ID defined in Fig. 6.. So the string of hexadecimal numbers is:

REQ:[01][00][00][00][06]
 RES:[00][01][02][03][04][05][06]

2- We want to read the data of the second COB-ID defined in Fig. 6.. So the string of hexadecimal numbers is:

REQ:[01][00][01][00][08]
 RES:[00][11][22][33][44][55][66][77][88]

3- We want to read the data of the first and second COB-ID defined in Fig. 6. together. So the string of hexadecimal numbers is:

REQ:[01][00][00][00][0E]
 RES:[00][01][02][03][04][05][06][11][22][33][44][55][66][77][88]

MECHANICAL DIMENSIONS:

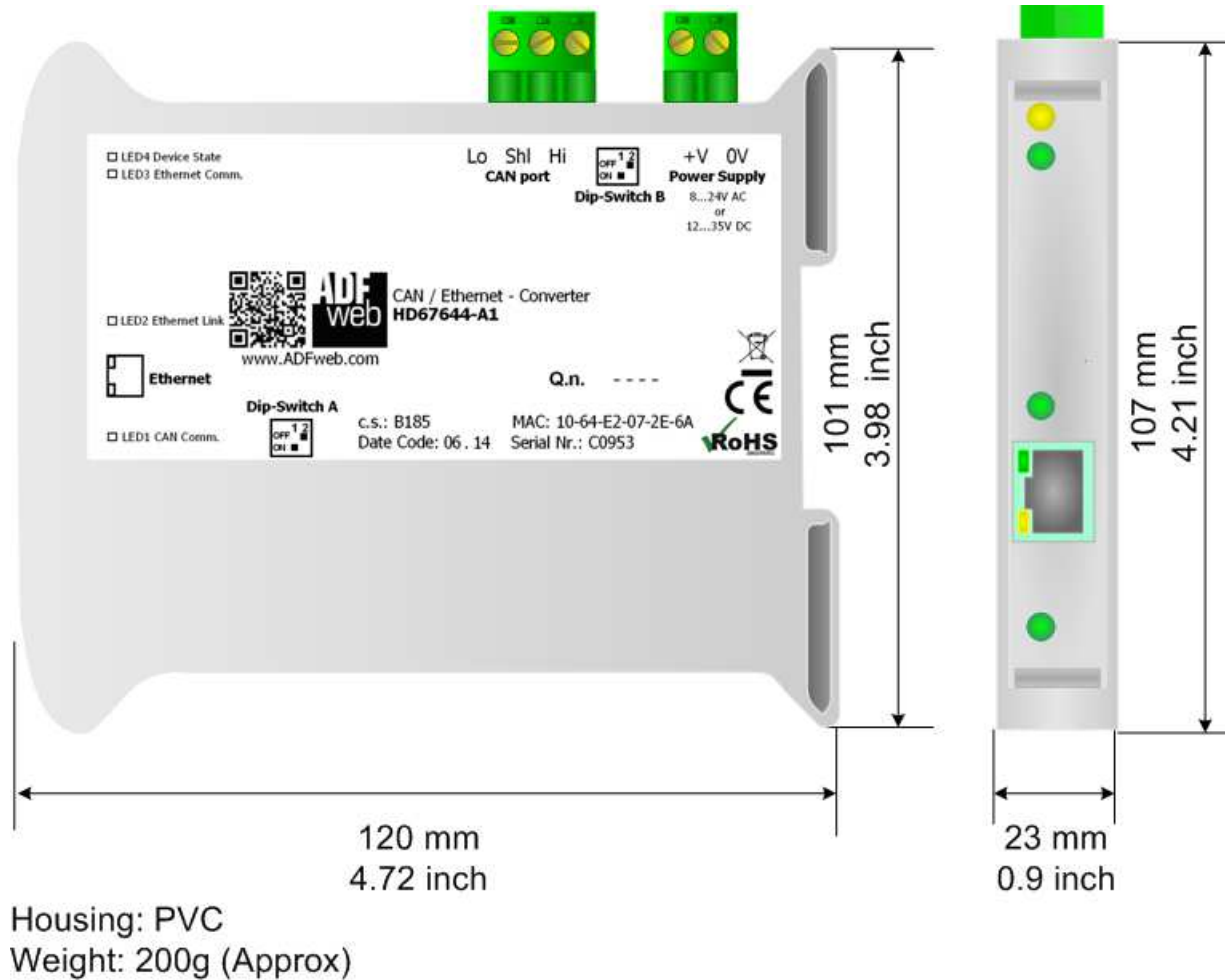
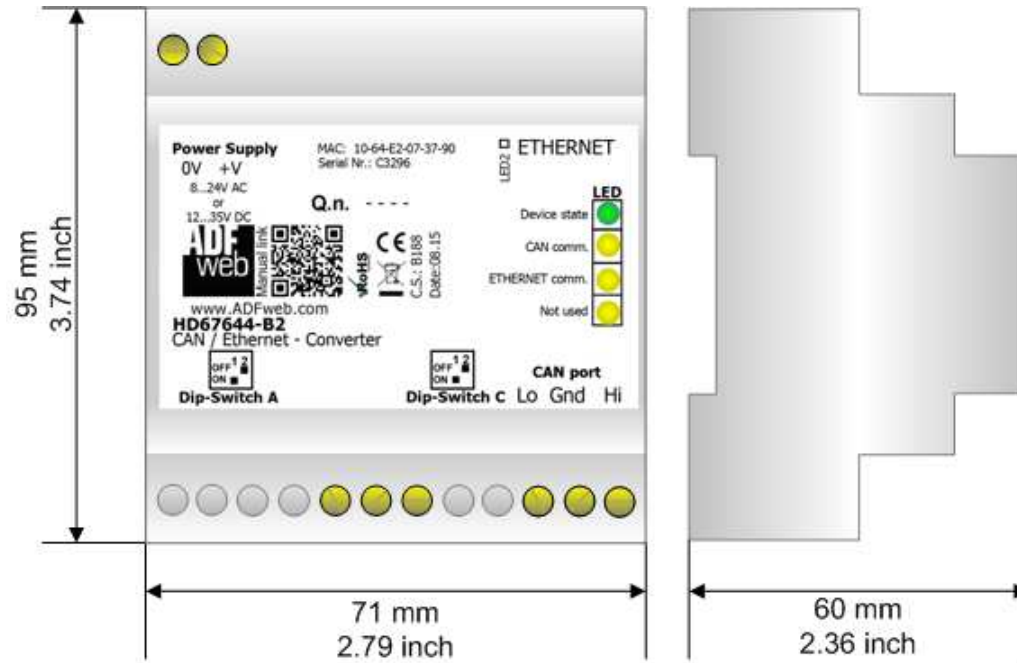
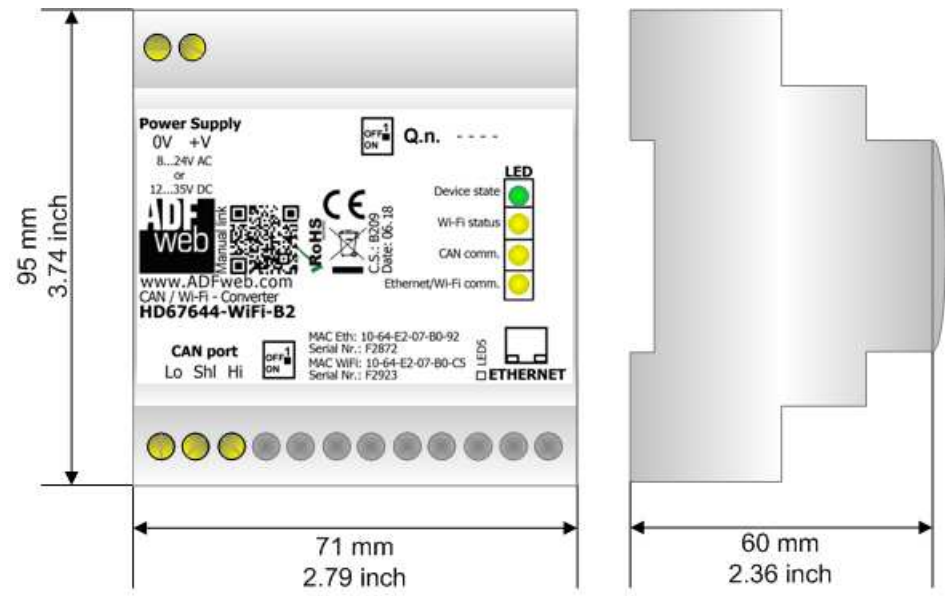

Figure 8a: Mechanical dimensions scheme for HD67644-A1



Housing: PVC
 Weight: 200g (Approx)

Figure 8b: Mechanical dimensions scheme for HD67644-B2



Housing: PVC
 Weight: 200g (Approx)

Figure 8c: Mechanical dimensions scheme for HD67644-WiFi-B2

ORDERING INFORMATIONS:

The ordering part number is formed by a valid combination of the following:

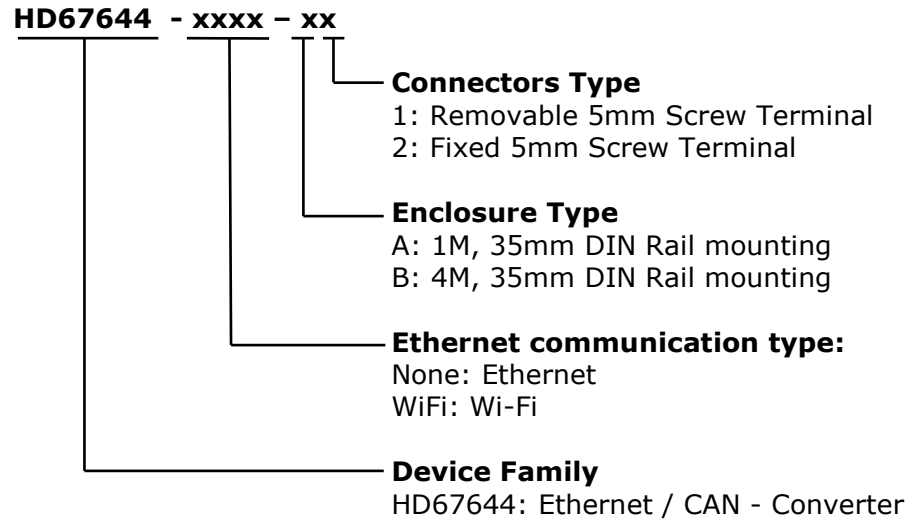

- Order Code: **HD67644-A1** - Ethernet / CAN - Converter (Housing type: A, Terminal Blocks Connectors)
- Order Code: **HD67644-B2** - Ethernet / CAN - Converter (Housing type: B, Terminal Blocks Connectors)
- Order Code: **HD67644-WiFi-B2** - Wi-Fi / CAN - Converter (Housing type: B, Terminal Blocks Connectors)

ACCESSORIES:

- Order Code: **AC34011** - 35mm Rail DIN - Power Supply 220/240V AC 50/60Hz – 12 V DC
- Order Code: **AC34012** - 35mm Rail DIN - Power Supply 220/240V AC 50/60Hz – 24 V DC

DISCLAIMER:

All technical content within this document can be modified without notice. The content of the document is a under continual renewal. For losses due to fire, earthquake, third party access or other accidents, or intentional or accidental abuse, misuse, or use under abnormal conditions repairs are charged to the user. ADFweb.com S.r.l. will not be liable for accidental loss of use or inability to use this product, such as loss of business income. ADFweb.com S.r.l. shall not be liable for consequences of improper use.

OTHER REGULATIONS AND STANDARDS:**WEEE INFORMATION**

Disposal of old electrical and electronic equipment (as in the European Union and other European countries with separate collection systems).

— This symbol on the product or on its packaging indicates that this product may not be treated as household rubbish. Instead, it should be taken to an applicable collection point for the recycling of electrical and electronic equipment. If the product is disposed correctly, you will help prevent potential negative environmental factors and impact of human health, which could otherwise be caused by inappropriate disposal. The recycling of materials will help to conserve natural resources. For more information about recycling this product, please contact your local city office, your household waste disposal service or the shop where you purchased the product.

RESTRICTION OF HAZARDOUS SUBSTANCES DIRECTIVE

The device respects the 2002/95/EC Directive on the restriction of the use of certain hazardous substances in electrical and electronic equipment (commonly referred to as Restriction of Hazardous Substances Directive or RoHS).

CE MARKING

The product conforms with the essential requirements of the applicable EC directives.

WARRANTIES AND TECHNICAL SUPPORT:

For fast and easy technical support for your ADFweb.com SRL products, consult our internet support at www.adfweb.com. Otherwise contact us at the address support@adfweb.com

RETURN POLICY:

If while using your product you have any problem and you wish to exchange or repair it, please do the following:

- Obtain a Product Return Number (PRN) from our internet support at www.adfweb.com. Together with the request, you need to provide detailed information about the problem.
- Send the product to the address provided with the PRN, having prepaid the shipping costs (shipment costs billed to us will not be accepted).

If the product is within the warranty of twelve months, it will be repaired or exchanged and returned within three weeks. If the product is no longer under warranty, you will receive a repair estimate.



ADFweb.com S.r.l.
Via Strada Nuova, 17
IT-31010 Mareno di Piave
TREVISO (Italy)
Phone +39.0438.30.91.31
Fax +39.0438.49.20.99
www.adfweb.com

