

User Manual

Revision 1.000
English

IO-Link / EtherNet/IP Slave - Converter

(Order Code: HD67871-A1-2A, HD67871-A1-4A,
HD67871-A1-2B, HD67871-A1-2A-2B)

for Website information:

www.adfweb.com/?Product=HD67871

for Price information:

www.adfweb.com/?Price=HD67871-A1-2A

www.adfweb.com/?Price=HD67871-A1-4A

www.adfweb.com/?Price=HD67871-A1-2B

www.adfweb.com/?Price=HD67871-A1-2A-2B

Benefits and Main Features:

- ✦ Triple electrical isolation
- ✦ Two Ethernet ports
- ✦ Temperature range: -40°C/+85°C (-40°F/+185°F)



User Manual

For others IO-Link devices, see also the following links:

IO-Link from/to ...

www.adfweb.com?Product=HD67860
www.adfweb.com?Product=HD67861
www.adfweb.com?Product=HD67862
www.adfweb.com?Product=HD67864
www.adfweb.com?Product=HD67864
www.adfweb.com?Product=HD67865
www.adfweb.com?Product=HD67866
www.adfweb.com?Product=HD67867
www.adfweb.com?Product=HD67868
www.adfweb.com?Product=HD67869
www.adfweb.com?Product=HD67870
www.adfweb.com?Product=HD67872
www.adfweb.com?Product=HD67873
www.adfweb.com?Product=HD67874
www.adfweb.com?Product=HD67875
www.adfweb.com?Product=HD67876
www.adfweb.com?Product=HD67877
www.adfweb.com?Product=HD67878

(Modbus Master)
 (Modbus Slave)
 (Modbus TCP Master)
 (Modbus TCP Slave)
 (BACnet Master)
 (BACnet Slave)
 (CAN)
 (CANopen)
 (DeviceNet Master)
 (DeviceNet Slave)
 (EtherNet/IP Master)
 (J1939)
 (MQTT)
 (NMEA0183)
 (NMEA2000)
 (PROFINET Slave)
 (SNMP Manager)
 (SNMP Agent)

Do you have an your customer protocol?

See the following links:

www.adfweb.com?Product=HD67876

Do you need to choose a device? do you want help?

Ask it to the following link:

www.adfweb.com?Cmd=helpme

INDEX:

	Page
INDEX	2
UPDATED DOCUMENTATION	2
REVISION LIST	2
WARNING	2
TRADEMARKS	2
SECURITY ALERT	3
EXAMPLE OF CONNECTION	4
CONNECTION SCHEME	5
CHARACTERISTICS	9
CONFIGURATION	9
POWER SUPPLY	10
FUNCTION MODES	11
LEDS	12
IO-LINK	13
AUX POWER SUPPLY	14
ETHERNET	15
USE OF COMPOSITOR SW67871	16
NEW PROJECT / OPEN PROJECT	17
SOFTWARE OPTIONS	18
SET COMMUNICATION	20
IO-LINK SET ACCESS	21
UPDATE DEVICE	30
PLC CONFIGURATION (FOR ETHERNET/IP)	32
MECHANICAL DIMENSIONS	36
ORDERING INFORMATIONS	37
ACCESSORIES	37
DISCLAIMER	38
OTHER REGULATIONS AND STANDARDS	38
WARRANTIES AND TECHNICAL SUPPORT	39
RETURN POLICY	39

UPDATED DOCUMENTATION:

Dear customer, we thank you for your attention and we remind you that you need to check that the following document is:

- Updated
- Related to the product you own

To obtain the most recently updated document, note the “document code” that appears at the top right-hand corner of each page of this document.

With this “Document Code” go to web page www.adfweb.com/download/ and search for the corresponding code on the page. Click on the proper “Document Code” and download the updates.

REVISION LIST:

Revision	Date	Author	Chapter	Description
1.000	13/03/2020	Ff	All	First release version

WARNING:

ADFweb.com reserves the right to change information in this manual about our product without warning. ADFweb.com is not responsible for any error this manual may contain.

TRADEMARKS:

All trademarks mentioned in this document belong to their respective owners.

SECURITY ALERT:**GENERAL INFORMATION**

To ensure safe operation, the device must be operated according to the instructions in the manual. When using the device, legal and safety regulation are required for each individual application. The same applies also when using accessories.

INTENDED USE

Machines and systems must be designed so the faulty conditions do not lead to a dangerous situation for the operator (i.e. independent limit switches, mechanical interlocks, etc.).

QUALIFIED PERSONNEL

The device can be used only by qualified personnel, strictly in accordance with the specifications.

Qualified personnel are persons who are familiar with the installation, assembly, commissioning and operation of this equipment and who have appropriate qualifications for their job.

RESIDUAL RISKS

The device is state-of-the-art and is safe. The instruments can represent a potential hazard if they are inappropriately installed and operated by untrained personnel. These instructions refer to residual risks with the following symbol:



This symbol indicates that non-observance of the safety instructions is a danger for people that could lead to serious injury or death and / or the possibility of damage.

CE CONFORMITY

The declaration is made by our company. You can send an email to support@adfweb.com or give us a call if you need it.

EXAMPLE OF CONNECTION:

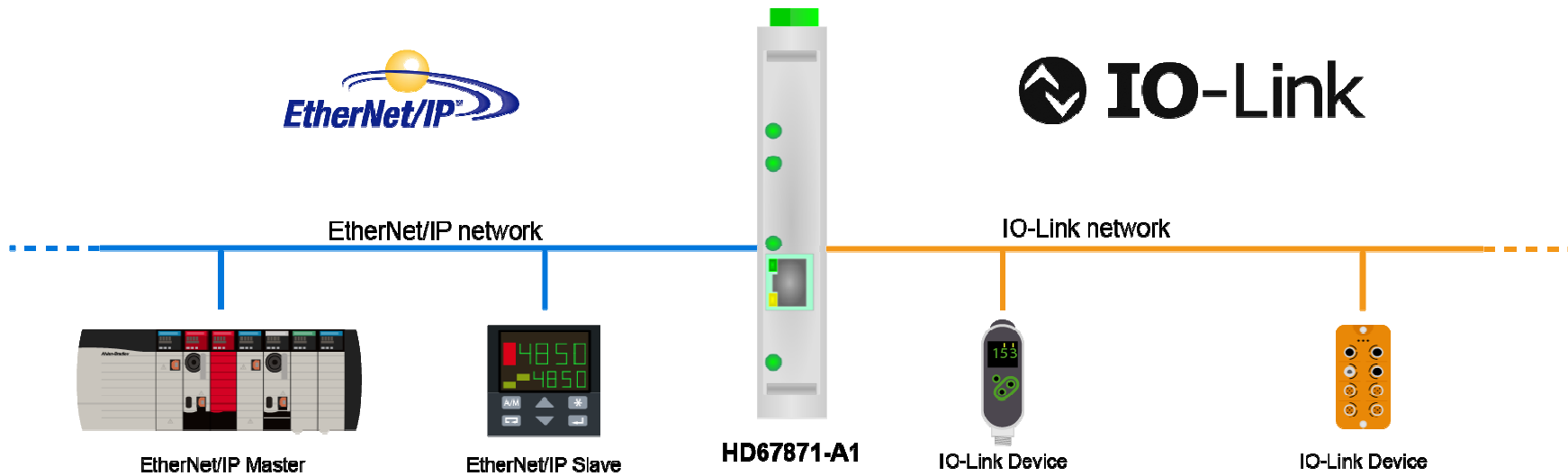

ADFweb **ADFweb.com srl**
 Tel. +39 0438 309 131 - Fax +39 0438 492 099
 info@adfweb.com - www.adfweb.com

CONNECTION SCHEME:

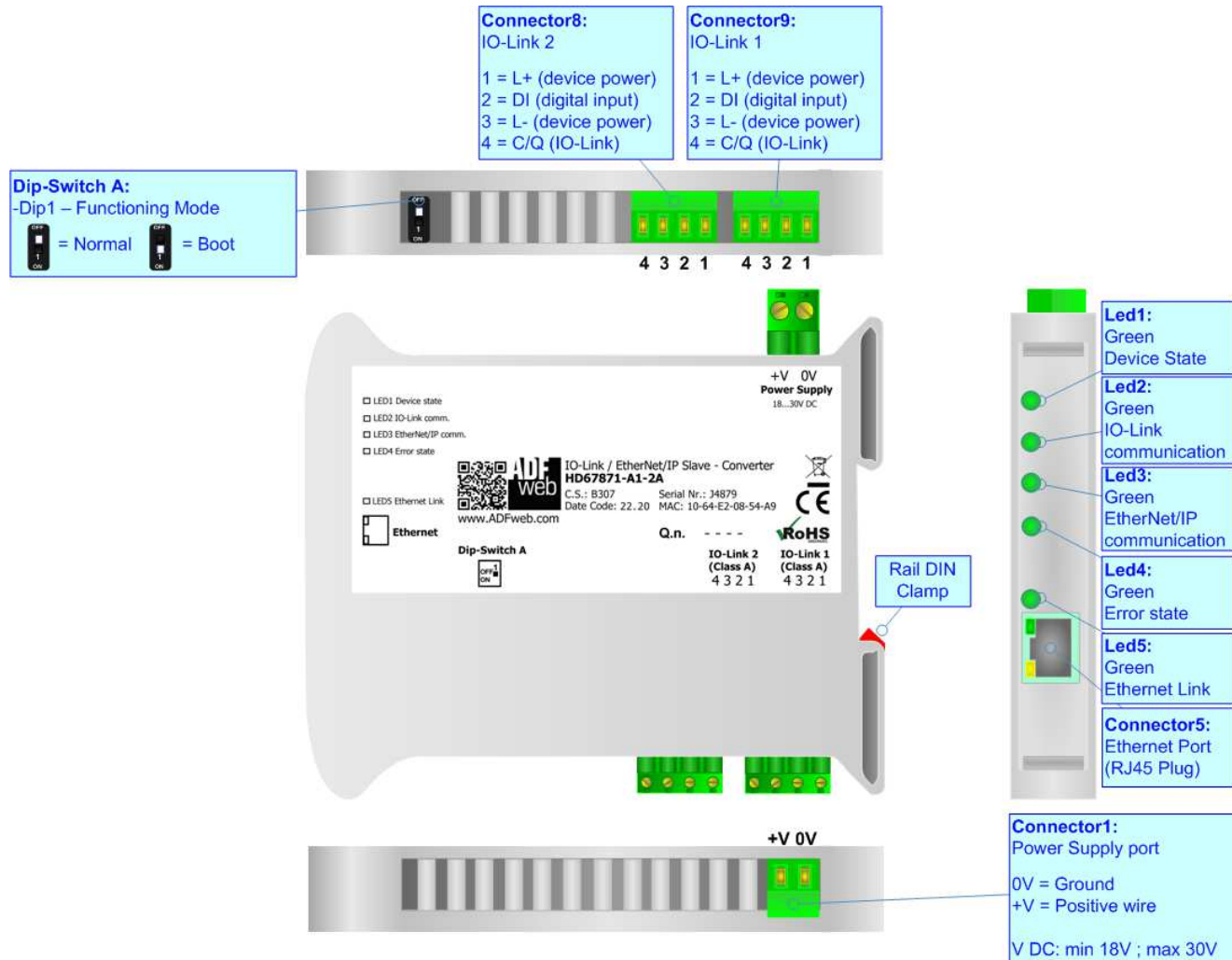

Figure 1a: Connection scheme for HD67871-A1-2A

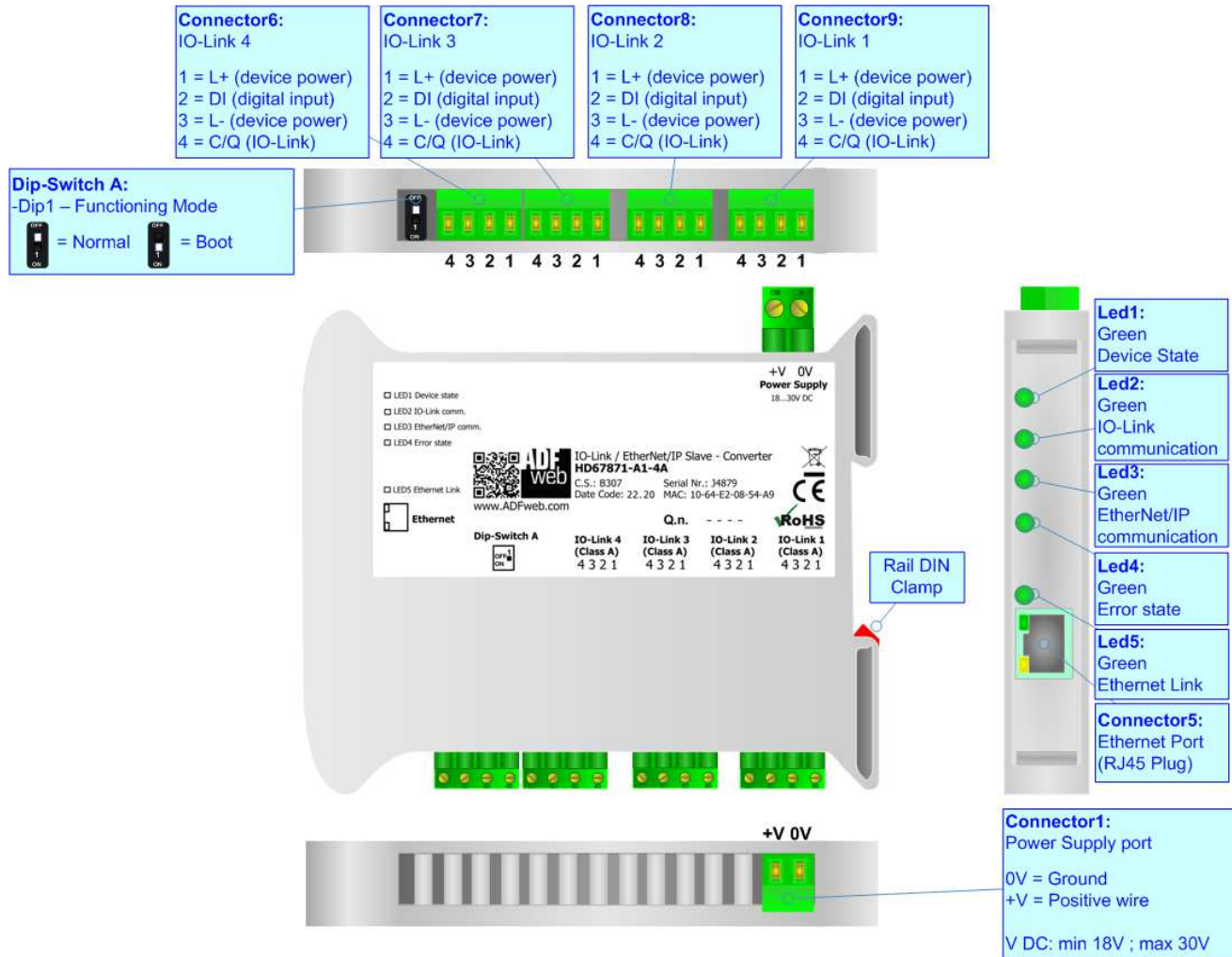

Figure 1b: Connection scheme for HD67871-A1-4A

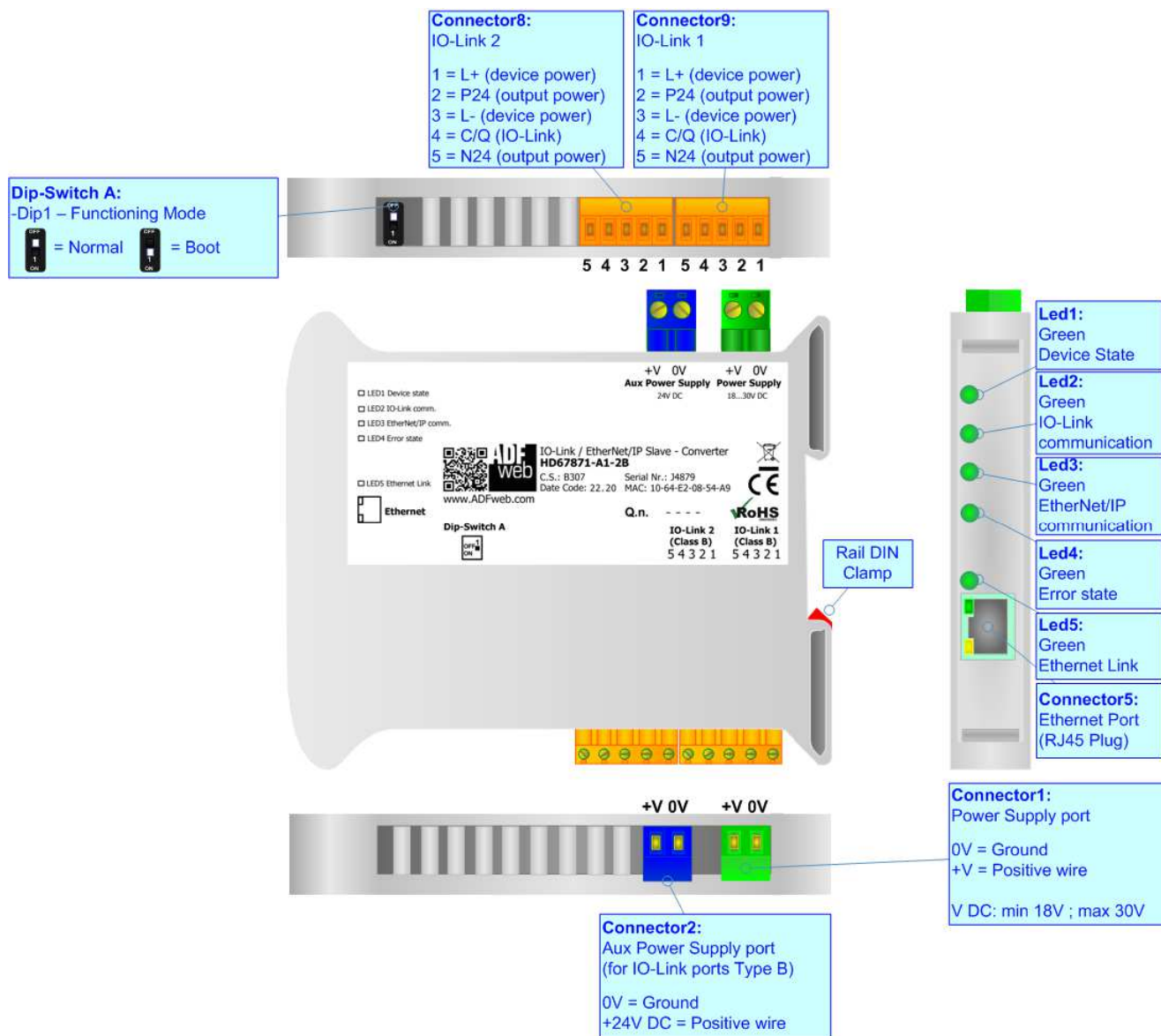

Figure 1c: Connection scheme for HD67871-A1-2B

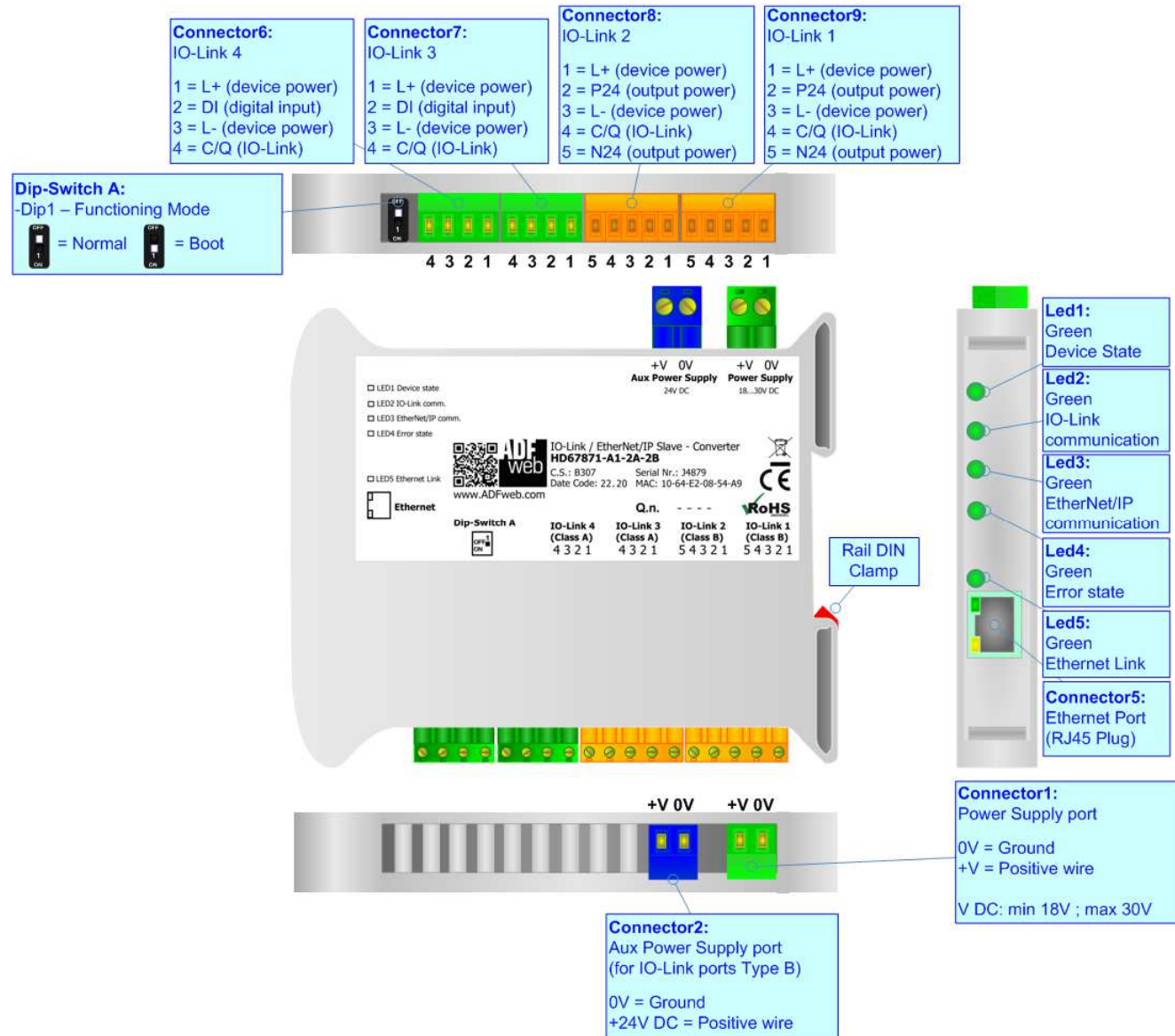

Figure 1d: Connection scheme for HD67871-A1-2A-2B

CHARACTERISTICS:

The HD67871-A1 is a IO-Link / EtherNet/IP Slave converter.

It allows the following characteristics:

- Up to 496 bytes in reading and 496 bytes in writing;
- Two-directional information between EtherNet/IP and IO-Link;
- Mountable on 35mm Rail DIN;
- Wide power supply input range: 8...24V AC or 12...35V DC;
- Wide temperature range: -40°C / 85°C [-40°F / +185°F].

CONFIGURATION:

You need Compositor SW67871 software on your PC in order to perform the following:

- Define the parameters of IO-Link;
- Define the parameters of EtherNet/IP;
- Define IO-Link variables to be read by the EtherNet/IP Master;
- Define IO-Link variables to be written by the EtherNet/IP Master;
- Update the device.

POWER SUPPLY:

The devices can be powered between a wide range of tensions. For more details see the two tables below.

	VDC	
	Vmin	Vmax
HD67863-A1-xx	18V	30V

Consumption at 24V DC:

Device	W/VA
HD67871-A1-xx	4



Warning:

It is necessary to add to this consumption the one required by the IO-Link devices connected to the IO-Link channels.



Caution: Not reverse the polarity power

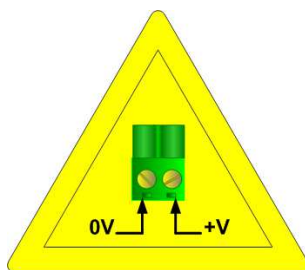

HD67871-A1-xx

Connector1:
Power Supply port
0V = Ground
+V = Positive wire
V DC: min 18V ; max 30V

Connector1:
Power Supply port
0V = Ground
+V = Positive wire
V DC: min 18V ; max 30V

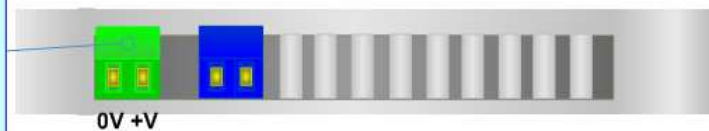

FUNCTION MODES:

The device has got two functions mode depending of the position of the Dip1 of 'Dip-Switch A':

- The first, with Dip1 in Off position (factory setting), is used for the normal working of the device.
- The second, with Dip1 in On position, is used for upload the Project/Firmware.

For the operations to follow for the updating (see 'UPDATE DEVICE' section).

According to the functioning mode, the LEDs will have specifics functions (see 'LEDS' section).



LEDS:

The device has got five LEDs that are used to give information of the functioning status. The various meanings of the LEDs are described in the table below.

LED	Normal Mode	Boot Mode
1: Device State (green)	Blinks slowly (~1Hz)	Blinks quickly: Boot state Blinks very slowly (~0.5Hz): update in progress
2: IO-Link comm. (green)	Flashing: IO-Link communication OFF: No IO-Link communication	Blinks quickly: Boot state Blinks very slowly (~0.5Hz): update in progress
3: EtherNet/IP comm. (green)	Flashing: EtherNet/IP communication OFF: No EtherNet/IP communication	Blinks quickly: Boot state Blinks very slowly (~0.5Hz): update in progress
4: Error state (green)	ON: at least one IO-Link device is not communicating OFF: No errors are present	Blinks quickly: Boot state Blinks very slowly (~0.5Hz): update in progress
5: Ethernet Link (green)	ON: Ethernet cable connected OFF: Ethernet cable not connected	ON: Ethernet cable connected OFF: Ethernet cable not connected

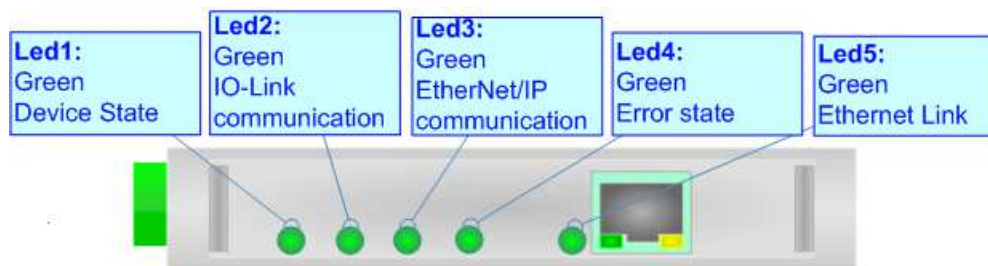

IO-LINK

IO-Link is the first globally standardized IO technology (IEC 61131-9) that communicates from the controller down to the lowest automation level. This universally applicable interface is a fieldbus-neutral point-to-point connection which uses standard unshielded cables. IO-Link sends all the sensor and actuator signals to the controller and in turn carries controller data to the sensor/actuator level with revolutionary consequences.

It is possible to have IO-Link device of two different type: IO-Link Class A and IO-Link Class B. ADFweb.com’s converters can manage both of them in relation to the product code selected.

IO-LINK CLASS A:

IO-Link Class A devices uses 4 pins on connectors and the input power required can be up to 200mA. These devices are normally sensors and actuators that don’t require high input power.

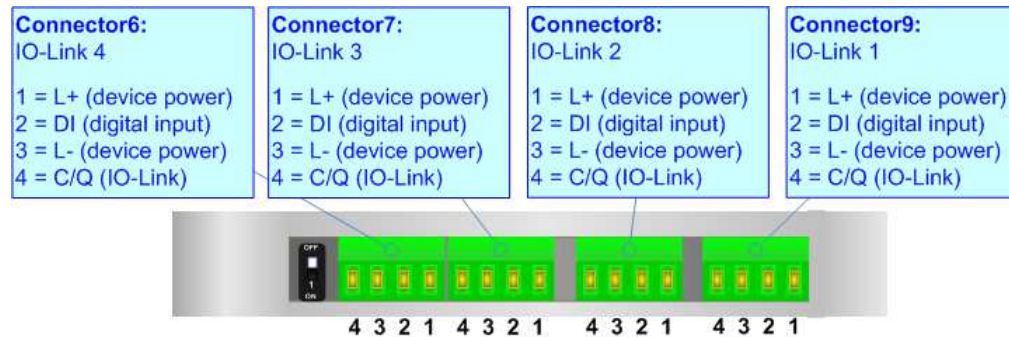

IO-LINK CLASS B:

IO-Link Class B devices uses 5 pins on connectors and they require an additional aux power supply used for the actuation. These devices are normally actuators.

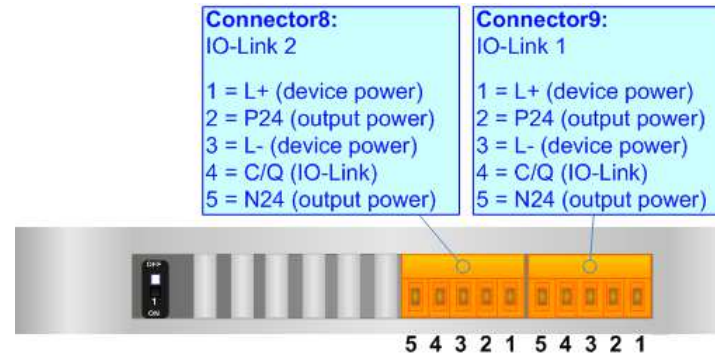

AUX POWER SUPPLY (for IO-Link Class B):

The Aux Power Supply port is used to provide the additional power supply for the IO-Link Class B. The input voltage is fixed to 24 V DC and the current depends on the input power required by the IO-Link devices connected to the IO-Link channels Class B.

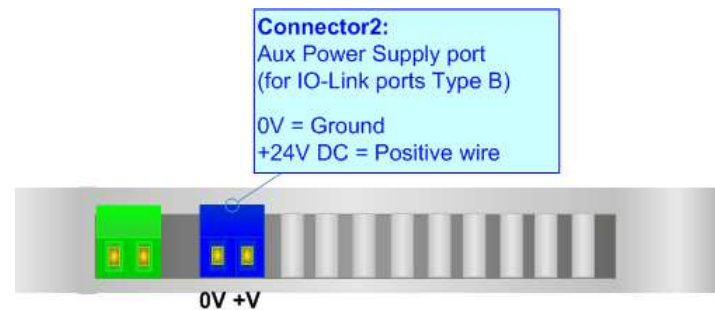

ETHERNET:

The Ethernet connection must be made using Connector5 of HD67871-A1 with at least a Category 5E cable. The maximum length of the cable should not exceed 100m. The cable has to conform to the T568 norms relative to connections in cat.5 up to 100 Mbps. To connect the device to an Hub/Switch is recommended the use of a straight cable, to connect the device to a PC/PLC/other is recommended the use of a cross cable.

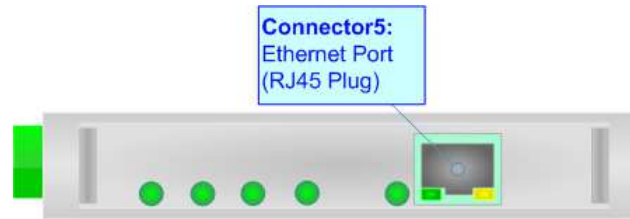

USE OF COMPOSITOR SW67871:

To configure the Converter, use the available software that runs with Windows called SW67871. It is downloadable on the site www.adfweb.com and its operation is described in this document. *(This manual is referenced to the last version of the software present on our web site).* The software works with MSWindows (XP, Vista, Seven, 8, 10; 32/64bit).

When launching the SW67871, the window below appears (Fig. 2).



Note:

It is necessary to have installed .Net Framework 4.



Figure 2: Main window for SW67871

NEW CONFIGURATION / OPEN CONFIGURATION:

The “**New Configuration**” button creates the folder which contains the entire device’s configuration.

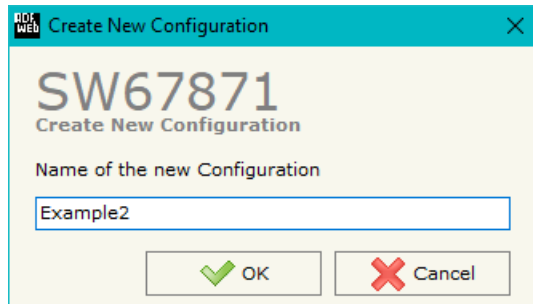

A device’s configuration can also be imported or exported:

- To clone the configurations of a programmable “IO-Link / EtherNet/IP Slave - Converter” in order to configure another device in the same manner, it is necessary to maintain the folder and all its contents;
- To clone a project in order to obtain a different version of the project, it is sufficient to duplicate the project folder with another name and open the new folder with the button “**Open Configuration**”.

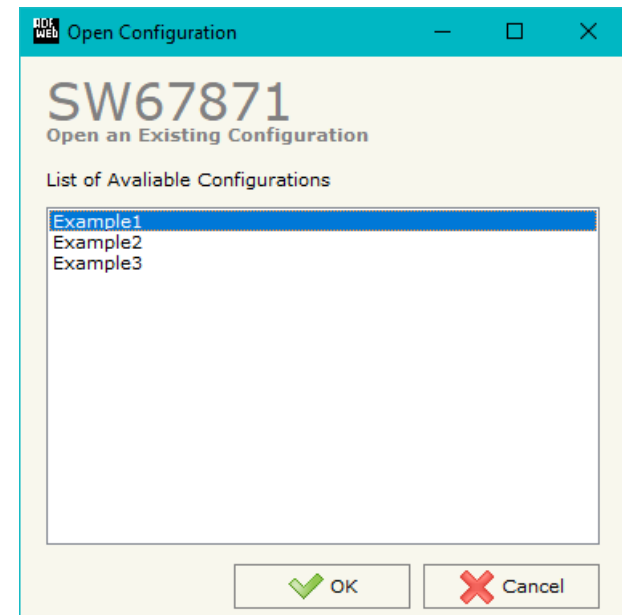

SOFTWARE OPTIONS:

By pressing the “**Settings**” () button there is the possibility to change the language of the software and check the updatings for the compositor.

In the section “Language” it is possible to change the language of the software.

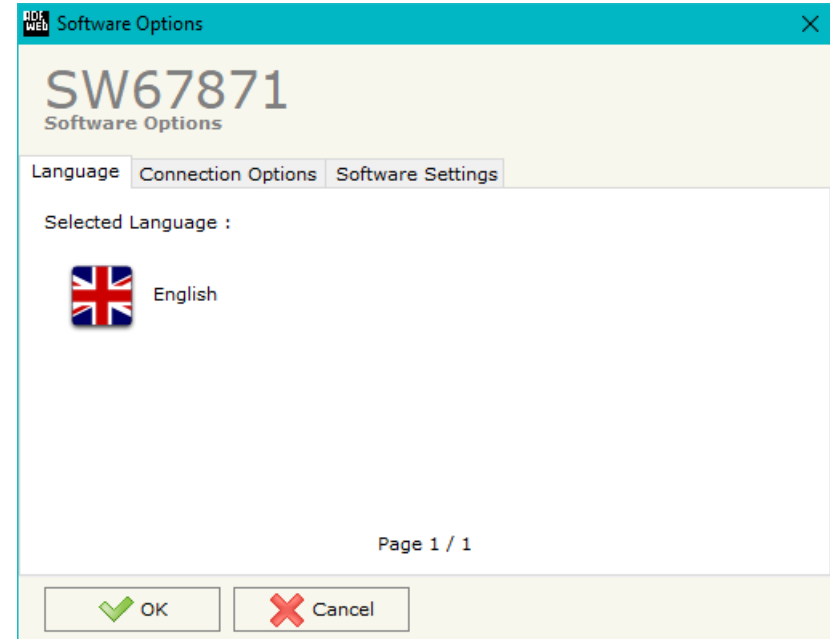
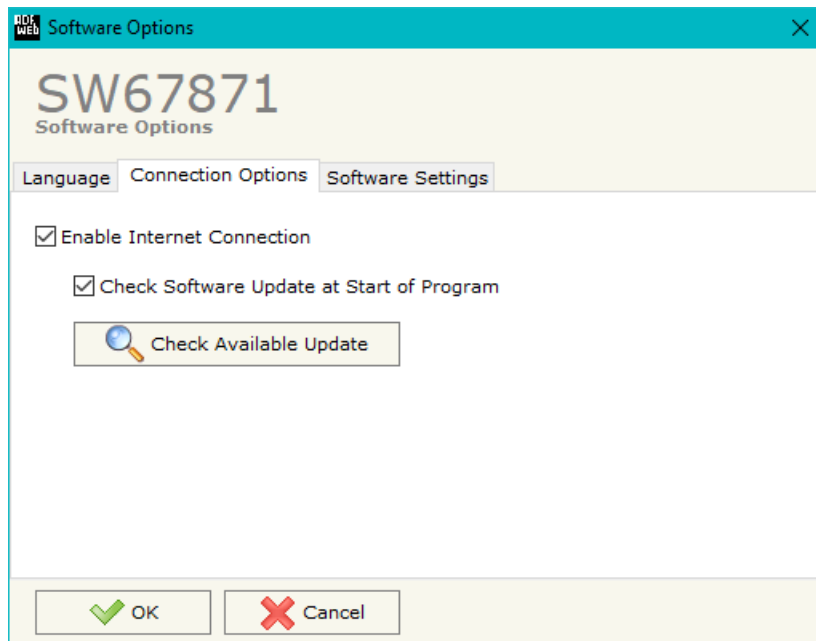

In the section “Connection Options”, it is possible to check if there are some updatings of the software compositor in ADFweb.com website. Checking the option “**Check Software Update at Start of Program**”, the SW67871 check automatically if there are updatings when it is launched.

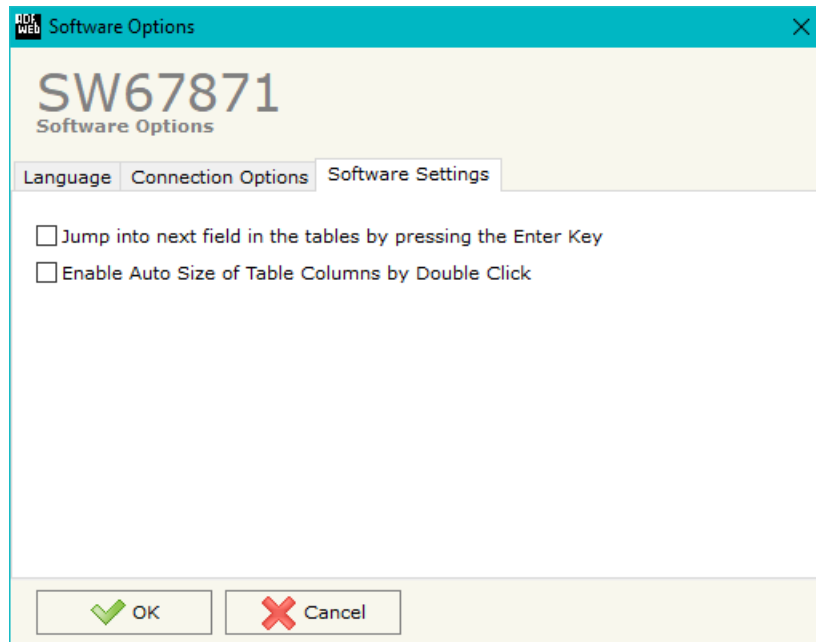

In the section "Software Settings", it is possible to enable/disable some keyboard's commands for an easier navigation inside the tables contained in the different sections of the software.

SET COMMUNICATION:

This section defines the fundamental communication parameters of EtherNet/IP.

By Pressing the **"Set Communication"** button from the main window for SW67871 (Fig. 2) the window "Set Communication" appears (Fig. 3).

The means of the fields for "IO-LINK" are:

- In the fields **"Select Device"** the type of IO-LINK channels is defined;

The means of the fields for "EtherNet/IP" are:

- In the fields **"IP Address"** the IP address for EtherNet/IP side of the converter is defined;
- In the fields **"SubNet Mask"** the SubNet Mask for EtherNet/IP side of the converter is defined;
- In the fields **"Gateway"** the default gateway of the net is defined. This feature can be enabled or disabled pressing the Check Box field. This feature is used for going out of the net;
- In the field **"Port"** the port used for EtherNet/IP communication is defined;
- In the field **"Number Bytes Input"** the number of input bytes of the converter is defined;
- In the field **"Number Bytes Output"** the number of output bytes of the converter is defined.

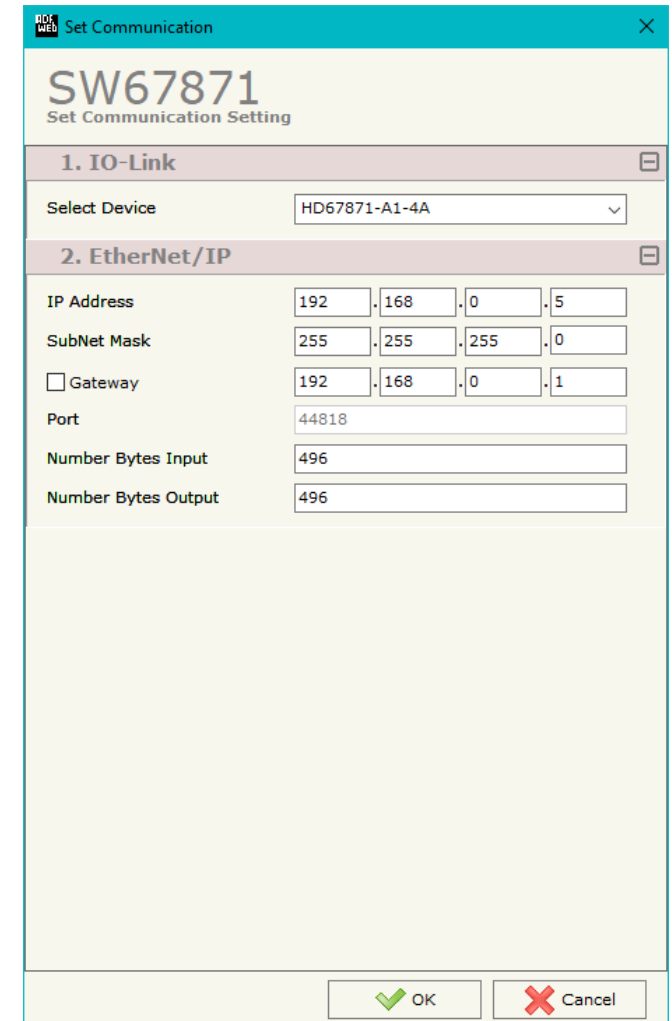

SW67871 Set Communication Setting	
1. IO-Link	
Select Device	HD67871-A1-4A
2. EtherNet/IP	
IP Address	192 . 168 . 0 . 5
SubNet Mask	255 . 255 . 255 . 0
<input type="checkbox"/> Gateway	192 . 168 . 0 . 1
Port	44818
Number Bytes Input	496
Number Bytes Output	496

Figure 3: "Set Communication" window

IO-LINK SET ACCESS:

By Pressing the “**IO-Link Set Access**” button from the main window for SW67871 (Fig. 2) the window “IO-Link Set Access” appears (Fig. 4). This section is used to define the list of IO-Link variables accessible from EtherNet/IP side.

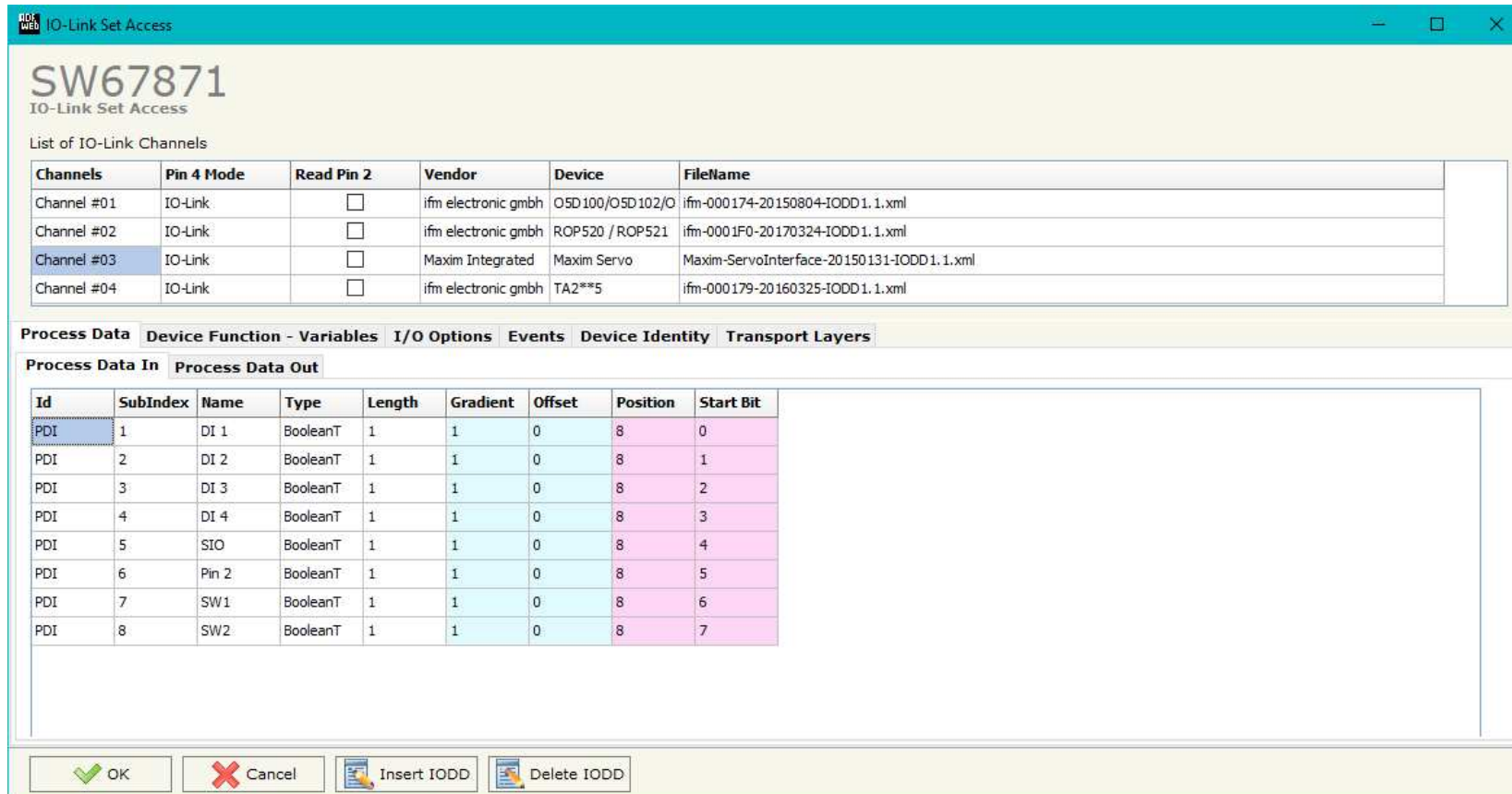

Figure 4: "IO-Link Set Access" window

In the "List of IO-Link Channel" section it is possible to configure all the IO-Link channels of the converter (Fig. 5).

Channels	Pin 4 Mode	Read Pin 2	Vendor	Device	FileName
Channel #01	IO-Link	<input type="checkbox"/>	ifm electronic gmbh	O5D100/O5D102/O	ifm-000174-20150804-IODD1.1.xml
Channel #02	IO-Link	<input type="checkbox"/>	ifm electronic gmbh	ROP520 / ROP521	ifm-0001F0-20170324-IODD1.1.xml
Channel #03	IO-Link	<input type="checkbox"/>	Maxim Integrated	Maxim Servo	Maxim-ServoInterface-20150131-IODD1.1.xml
Channel #04	IO-Link	<input type="checkbox"/>	ifm electronic gmbh	TA2**5	ifm-000179-20160325-IODD1.1.xml

Figure 5: "List of IO-Link Channel" section

The meanings of the fields are:

- In the field "**Channels**" the index of the IO-Link channel is defined;
- In the field "**Pin 4 Mode**" the mode of the pin 4 of the IO-Link device is defined (if "Io-Link" is selected, a file IODD is needed);
- If the field "**Read Pin 2**" is checked, the pin 2 of the IO-Link device is read;
- In the field "**Vendor**" the vendor of the IO-Link device is defined;
- In the field "**Device**" the name of the IO-Link device is defined;
- In the field "**FileName**" the name of the IODD file inserted is defined;

By clicking on **Insert IODD**, the window "IO-Link IODD Catalog" appears (Fig. 6). This section is used to select an IO-Link device. By clicking on **Add IODD** it is possible to add a new IODD file (the extension must be .xml).

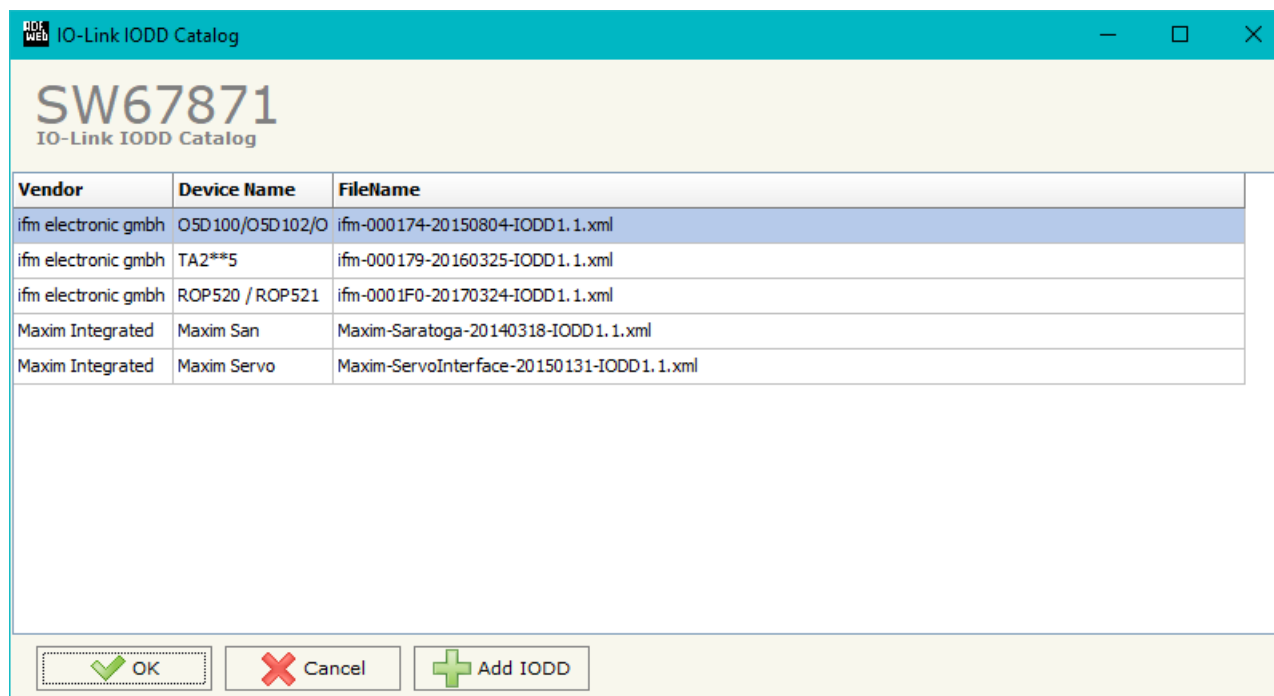

Figure 6: "IO-Link IODD Catalog" section

The "Process Data" section is used to define the IO-Link process data to link to EtherNet/IP side (Fig. 7).

Process Data								
Device Function - Variables I/O Options Events Device Identity Transport Layers								
Process Data In					Process Data Out			
Id	SubIndex	Name	Type	Length	Gradient	Offset	Position	Start Bit
PDO	1	Servo 1	IntegerT	8	1	0	0	0
PDO	2	Servo 2	IntegerT	8	1	0	1	0
PDO	3	Servo 3	IntegerT	8	1	0	2	0
PDO	4	Servo 4	IntegerT	8	1	0	3	0

Figure 7: "Process Data" section

The meanings of the fields are:

- In the field "**Id**" the Id of the IO-Link process data is defined;
- In the field "**SubIndex**" the subindex of the IO-Link process data is defined;
- In the field "**Name**" the name of the IO-Link process data is defined;
- In the field "**Type**" the data format of the IO-Link process data is defined;
- In the field "**Length**" the bit length of the IO-Link process data is defined;
- In the field "**Gradient**" the multiplication factor of the IO-Link process data is defined;
- In the field "**Offset**" the offset of the IO-Link process data is defined;
- In the field "**Position**" the starting byte of the internal memory arrays where mapping/getting the value is defined;
- In the field "**Start Bit**" the starting bit of the byte of the field "Position" is defined.

The “Device Function – Variables” section is used to define the IO-Link parameters to link to EtherNet/IP side (Fig. 8).

Process Data													Device Function - Variables		I/O Options		Events		Device Identity		Transport Layers	
Enable	Index	SubIndex	Id	Name	Type	Access	Length	SindAccSupp	TotBitLen	BitOff	Default	Value	Description									
<input type="checkbox"/>	542		V_Operating_Hours	Operating_Hours	UIntegerT	Read Only	16	False	16	0			Operating hours									
<input type="checkbox"/>	551		V_uni	uni	UIntegerT	Read Write	8	False	8	0	0		Selection of unit on									
<input type="checkbox"/>	552		V_diS	diS	RecordT	Read Write	16	False	16	0			Display settings									
<input type="checkbox"/>	552	1	V_diS	Display On / OFF	BooleanT	Read Write	1	False	16	7	false											
<input type="checkbox"/>	552	2	V_diS	Display orientation	BooleanT	Read Write	1	False	16	6	false											
<input type="checkbox"/>	552	3	V_diS	Update rate	UIntegerT	Read Write	6	False	16	0	2											
<input type="checkbox"/>	554		V_coLr	coLr	UIntegerT	Read Write	8	False	8	0	2		Assignment of the									
<input type="checkbox"/>	555		V_cFH	cFH	IntegerT	Read Write	16	False	16	0	512		Upper value for									
<input type="checkbox"/>	556		V_cFL	cFL	IntegerT	Read Write	16	False	16	0	256		Lower value for									
<input type="checkbox"/>	580		V_ou1_rPM	ou1_RPM	UIntegerT	Read Write	8	False	8	0	3		Output									
<input type="checkbox"/>	583		V_SP_FH1	SP_FH1	IntegerT	Read Write	16	False	16	0	5000		Switch point 1,									
<input type="checkbox"/>	584		V_rP_FL1	rP_FL1	IntegerT	Read Write	16	False	16	0	4000		Reset point 1,									

Buttons:

The meanings of the fields are:

- In the field “**Index**” the Index of the IO-Link parameter is defined;
- In the field “**SubIndex**” the Subindex of the IO-Link parameter is defined;
- In the field “**Id**” the Id of the IO-Link parameter is defined;
- In the field “**Name**” the name of the IO-Link parameter is defined;
- In the field “**Type**” the data format of the IO-Link parameter is defined;
- In the field “**Access**” the access type of the IO-Link parameter is defined;
- In the field “**Length**” the bit length of the IO-Link parameter is defined;
- In the field “**SindAccSupp**” the value of subindexAccessSupported attribute of the IO-Link parameter is defined;

Figure 8: “Device Function - Variables” section

- In the field "**TotBitLen**" the bit length of the array to which the IO-Link parameter refers is defined;
- In the field "**BitOff**" the bit offset of the IO-Link parameter is defined;
- In the field "**Default**" the default value of the IO-Link parameter is defined;
- In the field "**Value**" the starting value of the IO-Link parameter is defined;
- In the field "**Description**" a description of the IO-Link parameter is defined.

The "I/O Options" section is used to define how linking the data from IO-Link pin 2 and pin 4 to EtherNet/IP side (Fig. 9).

Process Data						Device Function - Variables						I/O Options						Events						Device Identity						Transport Layers					
Name	Access	Position	Start Bit	Invert	Menmonic																														
Pin 2	Read Only	5	0	<input checked="" type="checkbox"/>																															
Pin 4	Write	6	0	<input type="checkbox"/>																															

Figure 9: "I/O Options" section

The meanings of the fields are:

- In the field "**Name**" the name of the IO-Link pin is defined;
- In the field "**Access**" the access of the IO-Link pin is defined;
- In the field "**Position**" the starting byte of the internal memory arrays where mapping/getting the value is defined;
- In the field "**Start Bit**" the starting bit of the byte of the field "Position" is defined.
- If the field "**Invert**" the value to map/get is inverted;
- In the field "**Mnemonic**" a description of the variable is defined.

 **Note:**
IO-Link pin 2 can only be read and IO-LINK pin 4 can be defined if "Pin 4 Mode" is set to "DIn" or "DOut" in "List of IO-Link Channel" section.

The “Events” section is used to define the IO-LINK events to map on EtherNet/IP side (Fig. 10).

Enable	Code	Name	Type	TimeOut	Position	Start Bit	Menmonic
<input checked="" type="checkbox"/>	16928	Device temperature under-run	Warning	2000	3	0	
<input checked="" type="checkbox"/>	36016	nEA	Warning	2000	3	1	
<input checked="" type="checkbox"/>	36017	fAr	Warning	2000	3	2	
<input checked="" type="checkbox"/>	36020	+	Error	2000	3	3	
<input checked="" type="checkbox"/>	36021	-	Error	2000	3	4	
<input checked="" type="checkbox"/>	36004	ErP	Warning	2000	3	5	
<input checked="" type="checkbox"/>	36350	Test Event 1	Warning	2000	3	6	
<input checked="" type="checkbox"/>	36351	Test Event 2	Warning	2000	3	7	

Figure 10: “Events” section

The meanings of the fields are:

- In the field “**Code**” the code of the IO-Link event is defined;
- In the field “**Name**” the name of the IO-Link event is defined;
- In the field “**Type**” the type of the IO-Link event is defined;
- In the field “**TimeOut**” the duration of the IO-Link event after its activation is defined;
- In the field “**Position**” the starting byte of the internal memory arrays where mapping/getting the value is defined;
- In the field “**Start Bit**” the starting bit of the byte of the field “Position” is defined;
- In the field “**Mnemonic**” a description of the variable is defined.

In "Device Identity" section (Fig.11) and "Transport Identity" section (Fig. 12), the main features of the selected IO-Link device are reported. These characteristics are read from the IODD file.

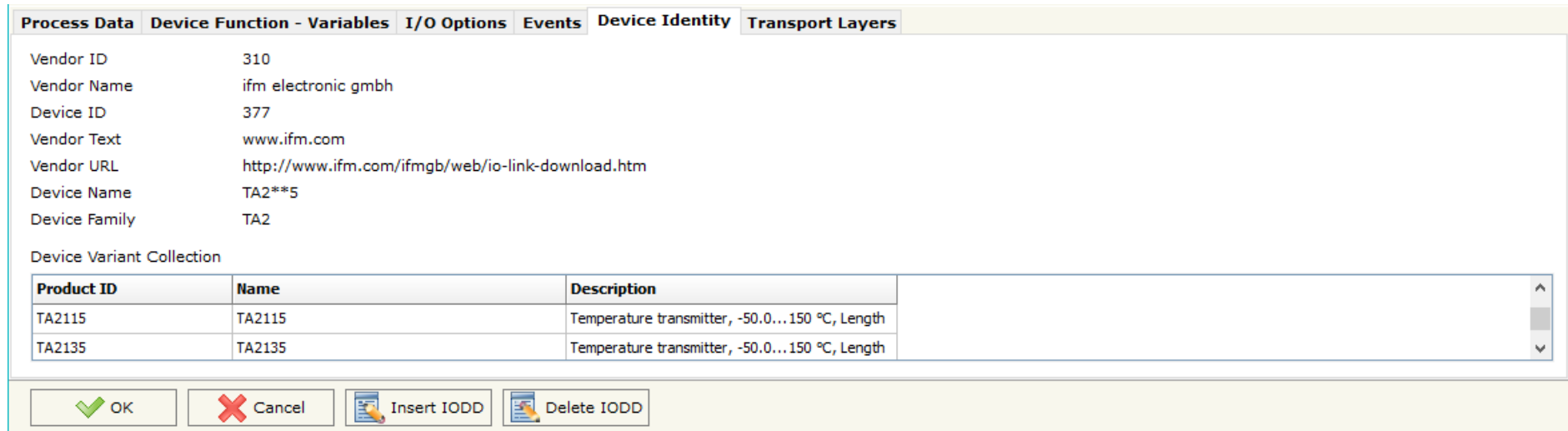

The screenshot shows the 'Transport Layers' section of the software interface. It contains the following data:

- Vendor ID: 310
- Vendor Name: ifm electronic gmbh
- Device ID: 377
- Vendor Text: www.ifm.com
- Vendor URL: http://www.ifm.com/ifmgb/web/io-link-download.htm
- Device Name: TA2**5
- Device Family: TA2

Device Variant Collection:

Product ID	Name	Description
TA2115	TA2115	Temperature transmitter, -50.0...150 °C, Length
TA2135	TA2135	Temperature transmitter, -50.0...150 °C, Length

Buttons: OK, Cancel, Insert IODD, Delete IODD

Figure 11: "Transport Layers" section

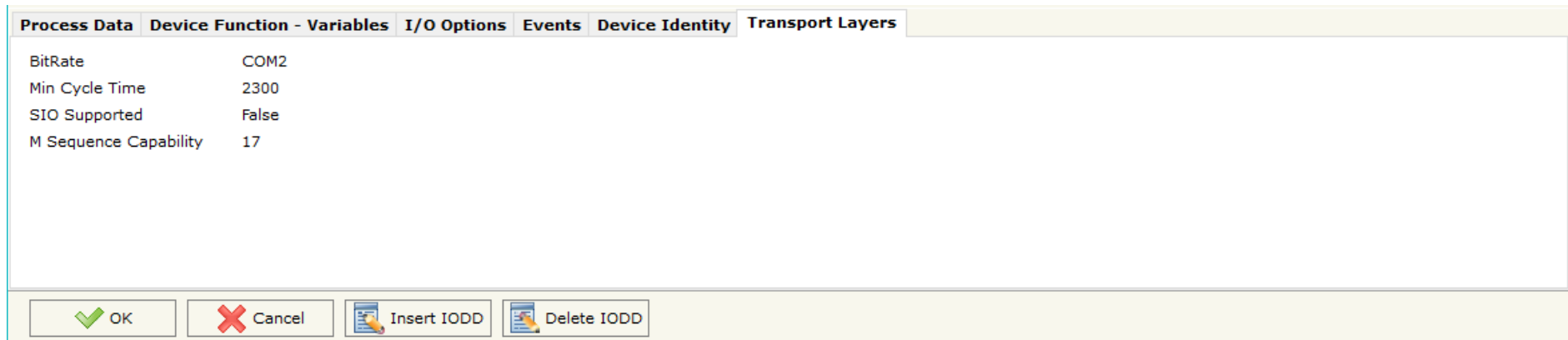

The screenshot shows the 'Device Identity' section of the software interface. It contains the following data:

- BitRate: COM2
- Min Cycle Time: 2300
- SIO Supported: False
- M Sequence Capability: 17

Buttons: OK, Cancel, Insert IODD, Delete IODD

Figure 12: "Device Identity" section

UPDATE DEVICE:

By pressing the **“Update Device”** button, it is possible to load the created Configuration into the device; and also the Firmware, if necessary. This by using the Ethernet port.

If you don't know the actual IP address of the device, you have to use this procedure:

- Turn OFF the Device;
- Put Dip1 of 'Dip-Switch A' in ON position;
- Turn ON the device
- Connect the Ethernet cable;
- Insert the IP **“192.168.2.205”**;
- Select which operations you want to do;
- Press the **“Execute update firmware”** button to start the upload;
- When all the operations are “OK” turn OFF the Device;
- Put Dip1 of 'Dip-Switch A' in OFF position;
- Turn ON the device.

If you know the actual IP address of the device, you have to use this procedure:

- Turn ON the Device with the Ethernet cable inserted;
- Insert the actual IP of the Converter;
- Select which operations you want to do;
- Press the **“Execute update firmware”** button to start the upload;
- When all the operations are “OK” the device automatically goes at Normal Mode.

At this point the configuration/firmware on the device is correctly updated.

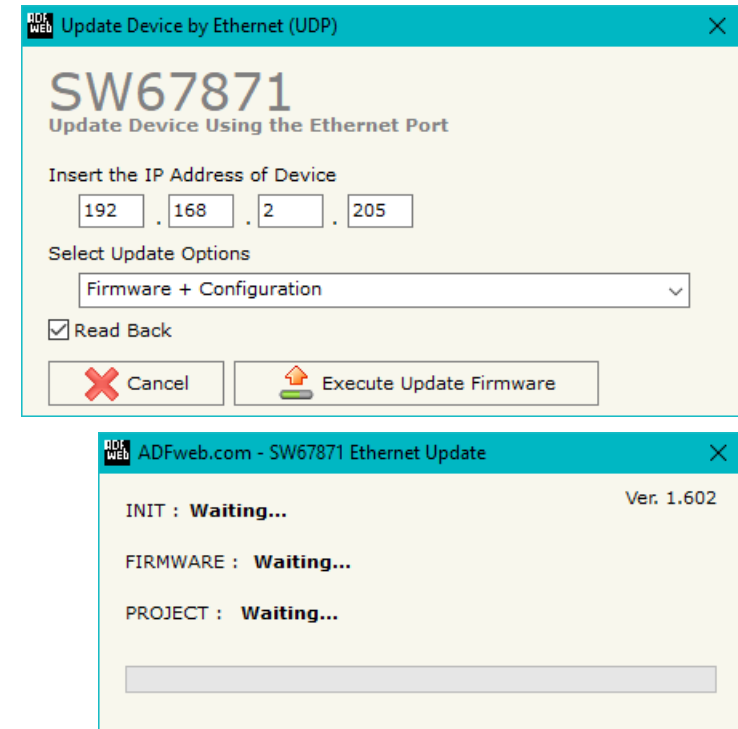

Figure 13: “Update device” windows

**Note:**

When you receive the device, for the first time, you also have to update the Firmware in the HD67871 device.

**Warning:**

If Fig. 14 appears when you try to do the Update try these points before seeking assistance:

- ➔ Try to repeat the operations for the updating;
- ➔ Try with another PC;
- ➔ Try to restart the PC;
- ➔ Check the LAN settings;
- ➔ If you are using the program inside a Virtual Machine, try to use in the main Operating System;
- ➔ If you are using Windows Seven, Vista, 8 or 10 make sure that you have the administrator privileges;
- ➔ In case you have to program more than one device, using the "UDP Update", you have to cancel the ARP table every time you connect a new device on Ethernet. For do this you have to launch the "Command Prompt" and write the command "arp -d". Pay attention that with Windows Vista, Seven, 8, 10 you have to launch the "Command Prompt" with Administrator Rights;
- ➔ Pay attention at Firewall lock.

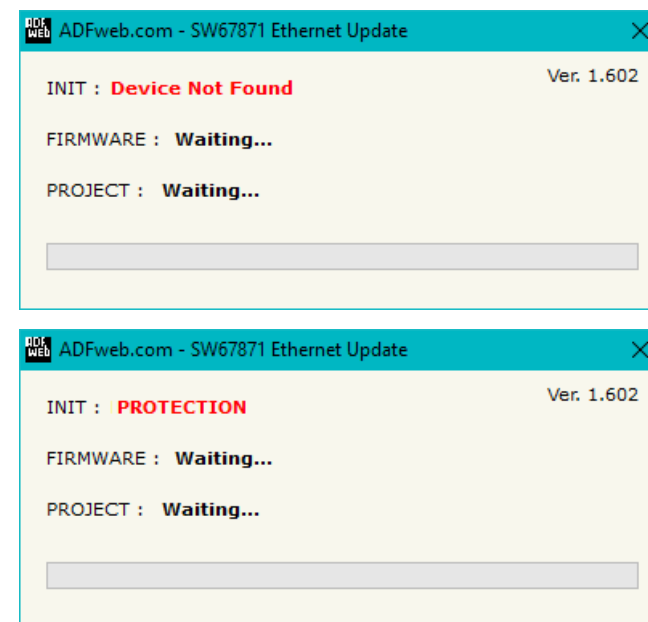

Figure 14: "Error" window

**Warning:**

In the case of HD67871 you have to use the software "SW67871": www.adfweb.com/download/filefold/SW67871.zip.

PLC CONFIGURATION (for EtherNet/IP):

The configuration and commissioning of the EtherNet/IP Converter as described on the following pages was accomplished with the help of the "RSLogix 5000" software of Rockwell Automation. In case of using a control system from another supplier please attend to the associated documentation.

These are the steps to follow:

- 1) Create a "Generic Ethernet Module" under the Ethernet section in the I/O Configuration tree.

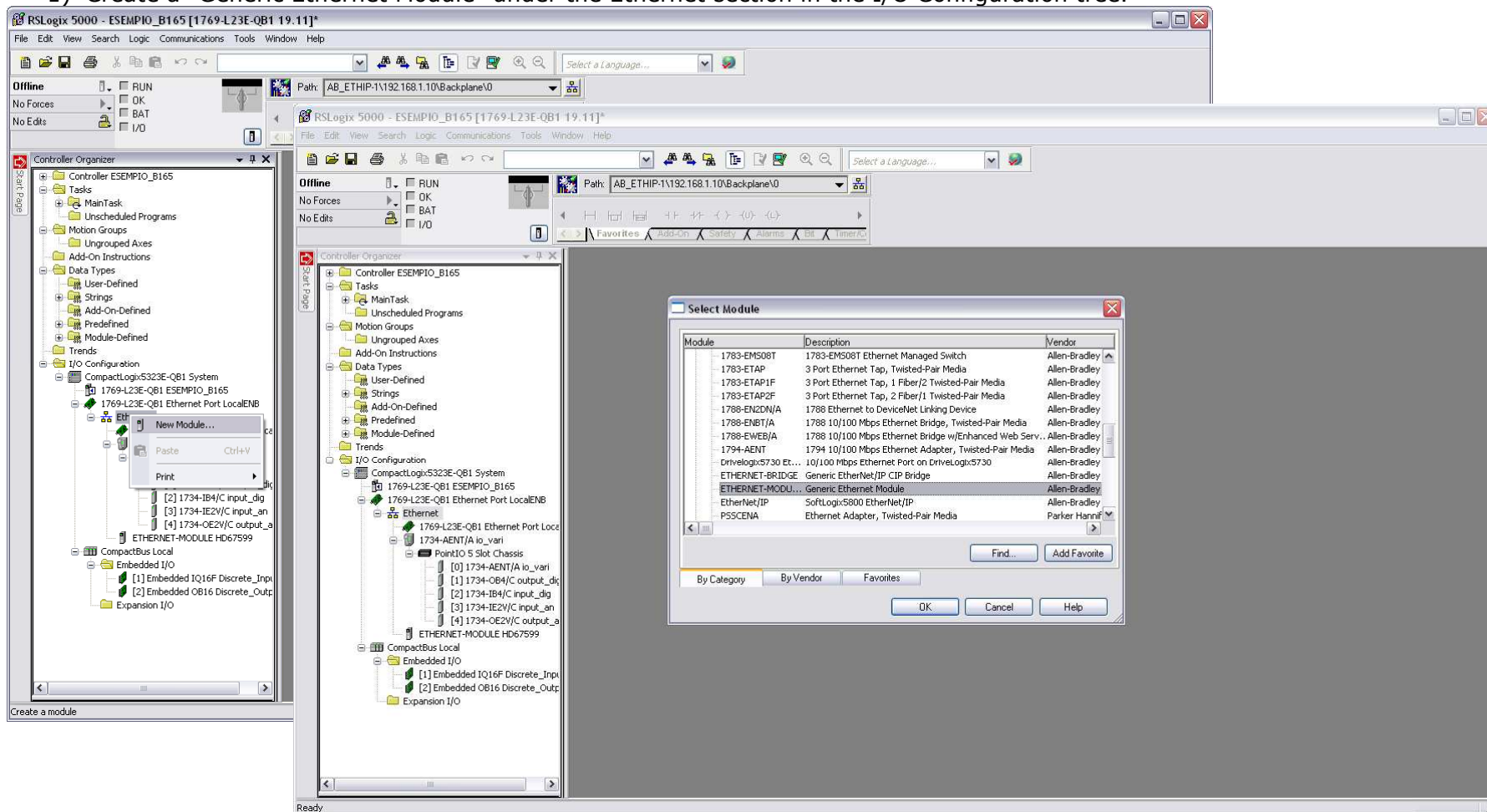

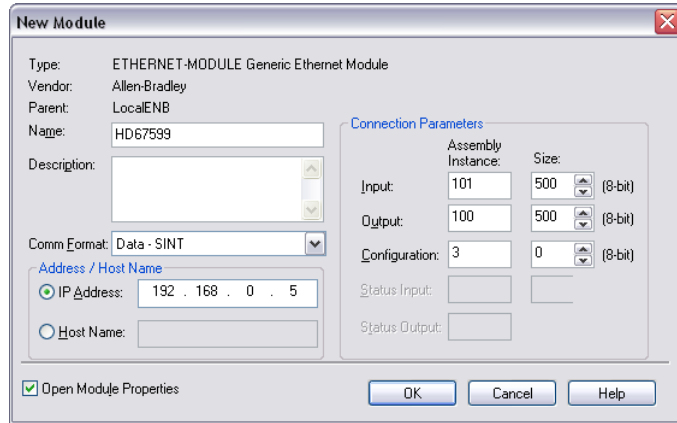

2) Edit the settings of the new Generic Ethernet Module. As shown in the screen shot below, the module was named "HD67871" and the IP-address assigned is 192.168.0.5.

For the Comm Format "Data – SINT" shall be selected as the data type.

RSLogix 5000 requires a configuration assembly instance. Both modules do not provide a configuration assembly instance. Therefore it is allowed to select an instance of 3 and to set the value to zero.

3) The setting of 10msec for the "Requested Packet Interval (RPI)" is adequate but it is possible to change this value as required. A lower value of 2ms shall not be selected.



Warning:

The field "Use Unicast Connection over EtherNet/IP" must be checked.

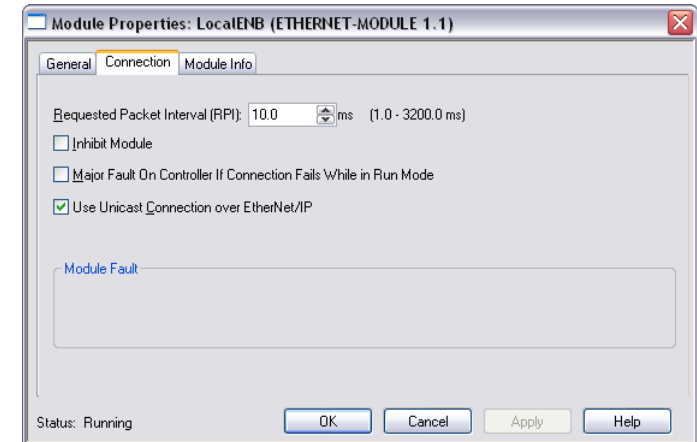

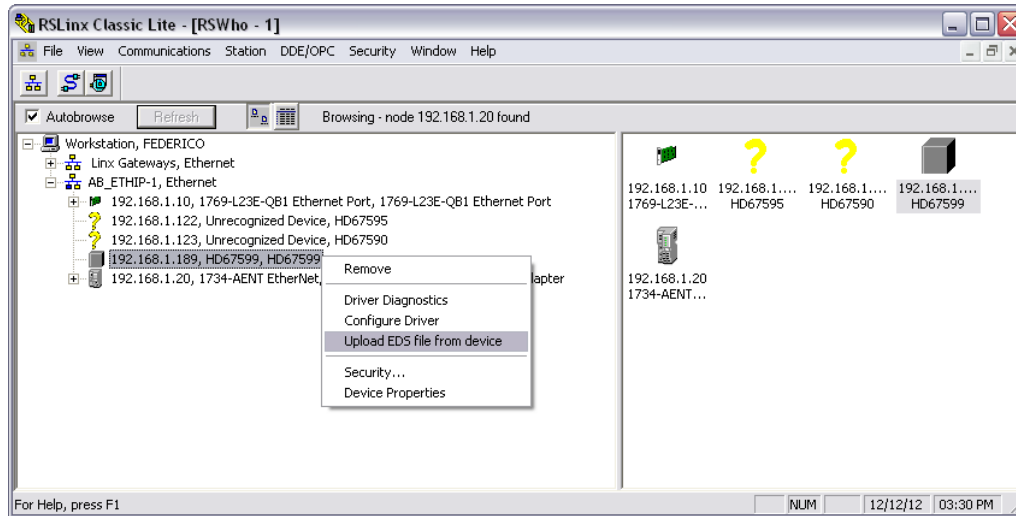

5) With "RSLinx Classic Lite", after have done a network scan (RSWho), and finding the EtherNet/IP device, it is possible to load the EDS file for the device in order to have the "Module Info" compiled.

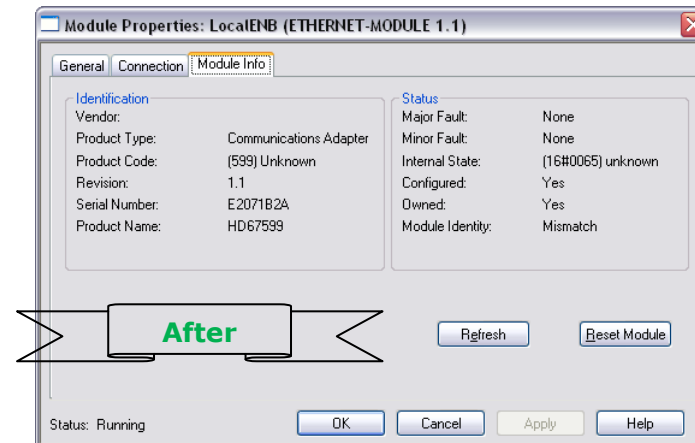
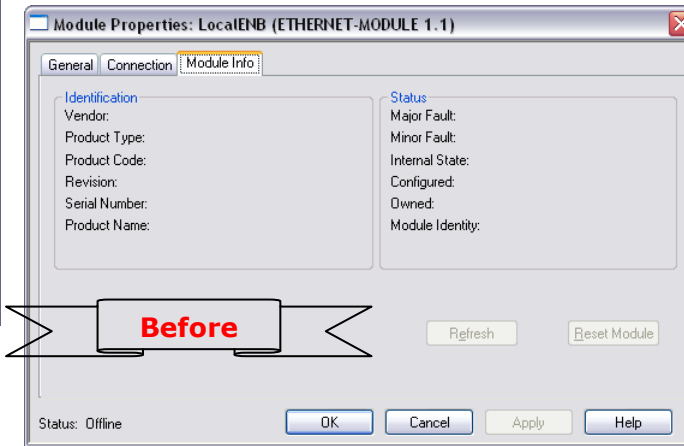

MECHANICAL DIMENSIONS:

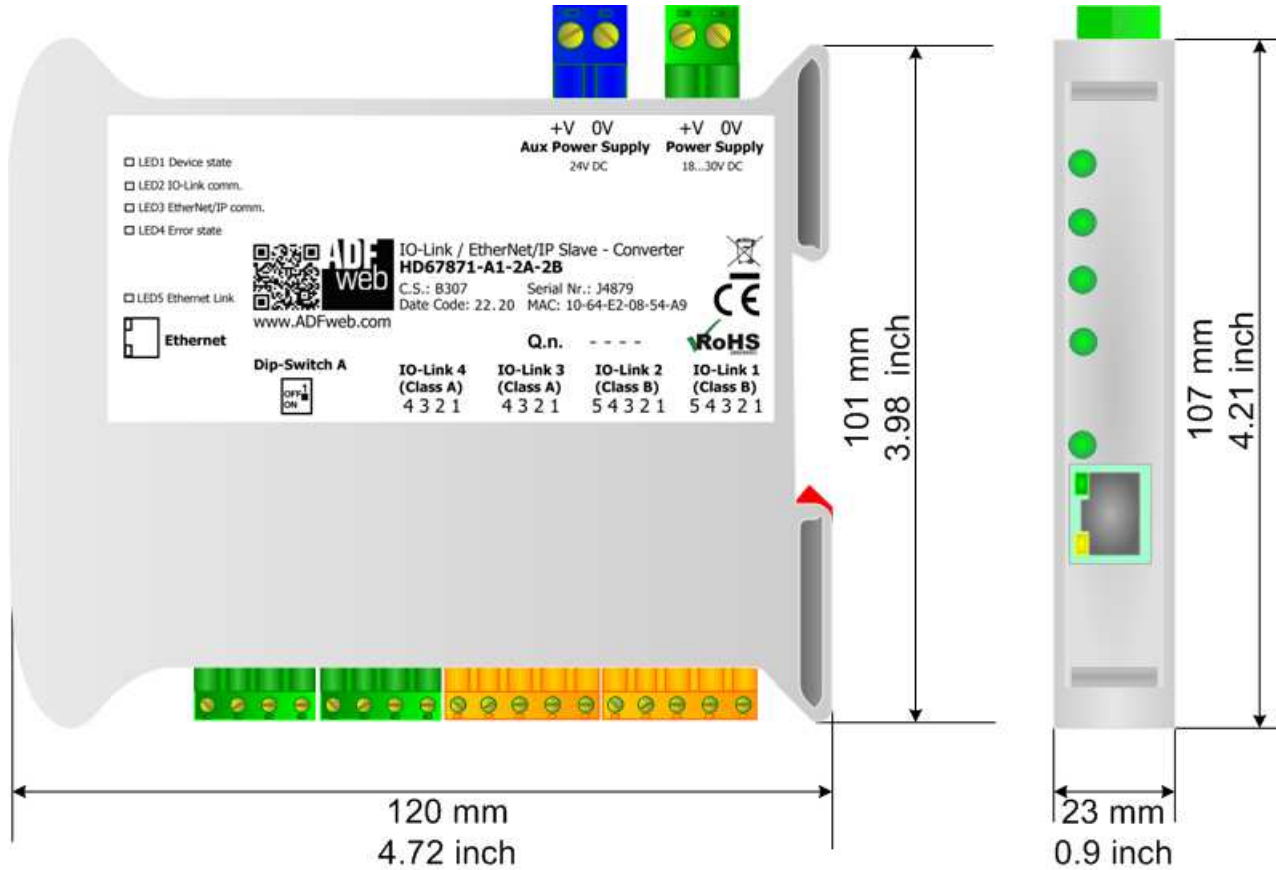

Housing: PVC
Weight: 200g (Approx)

Figure 15: Mechanical dimensions scheme for HD67871-A1-xx

ORDERING INFORMATIONS:

The ordering part number is formed by a valid combination of the following:

HD67871 - A 1 - x x

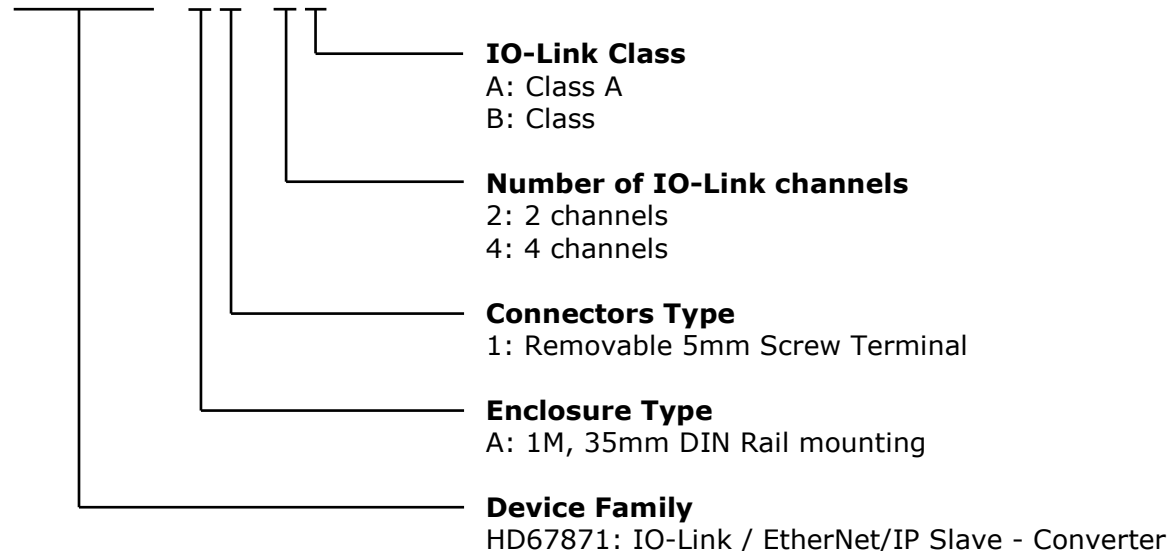

- Order Code: **HD67871-A1-2A** - IO-Link / EtherNet/IP Slave – Converter (IO-Link ports: 2 x Class A)
- Order Code: **HD67871-A1-4A** - IO-Link / EtherNet/IP Slave – Converter (IO-Link ports: 4 x Class A)
- Order Code: **HD67871-A1-2B** - IO-Link / EtherNet/IP Slave – Converter (IO-Link ports: 2 x Class B)
- Order Code: **HD67871-A1-2A-2B** - IO-Link / EtherNet/IP Slave – Converter (IO-Link ports: 2 x Class A and 2 x Class B)

ACCESSORIES:

- Order Code: **AC34011** - Rail DIN - Power Supply 220/240V AC 50/60Hz – 12 V DC
- Order Code: **AC34012** - Rail DIN - Power Supply 220/240V AC 50/60Hz – 24 V DC

DISCLAIMER:

All technical content within this document can be modified without notice. The content of the document is a under continual renewal. For losses due to fire, earthquake, third party access or other accidents, or intentional or accidental abuse, misuse, or use under abnormal conditions repairs are charged to the user. ADFweb.com S.r.l. will not be liable for accidental loss of use or inability to use this product, such as loss of business income. ADFweb.com S.r.l. shall not be liable for consequences of improper use.

OTHER REGULATIONS AND STANDARDS:**WEEE INFORMATION**

Disposal of old electrical and electronic equipment (as in the European Union and other European countries with separate collection systems).

— This symbol on the product or on its packaging indicates that this product may not be treated as household rubbish. Instead, it should be taken to an applicable collection point for the recycling of electrical and electronic equipment. If the product is disposed correctly, you will help prevent potential negative environmental factors and impact of human health, which could otherwise be caused by inappropriate disposal. The recycling of materials will help to conserve natural resources. For more information about recycling this product, please contact your local city office, your household waste disposal service or the shop where you purchased the product.

RESTRICTION OF HAZARDOUS SUBSTANCES DIRECTIVE

The device respects the 2002/95/EC Directive on the restriction of the use of certain hazardous substances in electrical and electronic equipment (commonly referred to as Restriction of Hazardous Substances Directive or RoHS).

CE MARKING

The product conforms with the essential requirements of the applicable EC directives.

WARRANTIES AND TECHNICAL SUPPORT:

For fast and easy technical support for your ADFweb.com SRL products, consult our internet support at www.adfweb.com.
Otherwise contact us at the address support@adfweb.com

RETURN POLICY:

If while using your product you have any problem and you wish to exchange or repair it, please do the following:

- Obtain a Product Return Number (PRN) from our internet support at www.adfweb.com. Together with the request, you need to provide detailed information about the problem.
- Send the product to the address provided with the PRN, having prepaid the shipping costs (shipment costs billed to us will not be accepted).

If the product is within the warranty of twelve months, it will be repaired or exchanged and returned within three weeks. If the product is no longer under warranty, you will receive a repair estimate.



ADFweb.com S.r.l.
Via Strada Nuova, 17
IT-31010 Mareno di Piave
TREVISO (Italy)
Phone +39.0438.30.91.31
Fax +39.0438.49.20.99
www.adfweb.com

