

User Manual

Revision 1.000
English

IEC61850 Client / DeviceNet Slave - Converter

(Order Code: HD67770-A1)

for Website information:

<http://www.adfweb.com/?Product=HD67770>

for Price information:

<http://www.adfweb.com/?Price=HD67770-A1>

Benefits and Main Features:

- ⊕ Triple electrical isolation
- ⊕ Two Ethernet ports
- ⊕ Temperature range: -40°C/+85°C (-40°F/+185°F)



For others IEC61850 Client devices, see also the following links:

IEC61850 Client from/to ...

www.adfweb.com?Product=HD67765
www.adfweb.com?Product=HD67766
www.adfweb.com?Product=HD67767
www.adfweb.com?Product=HD67768
www.adfweb.com?Product=HD67769
www.adfweb.com?Product=HD67771
www.adfweb.com?Product=HD67772
www.adfweb.com?Product=HD67773
www.adfweb.com?Product=HD67774
www.adfweb.com?Product=HD67775
www.adfweb.com?Product=HD67776
www.adfweb.com?Product=HD67777
www.adfweb.com?Product=HD67778
www.adfweb.com?Product=HD67779
www.adfweb.com?Product=HD67780
www.adfweb.com?Product=HD67781
www.adfweb.com?Product=HD67D34
www.adfweb.com?Product=HD67F34
www.adfweb.com?Product=HD67E14
www.adfweb.com?Product=HD67E64

(Modbus Slave)
(Modbus TCP Slave)
(BACnet Slave)
(CAN)
(CANopen)
(EtherNet/IP Slave)
(J1939)
(KNX)
(MQTT)
(NMEA0183)
(NMEA2000)
(PROFIBUS Slave)
(PROFINET)
(SNMP Agent)
(Serial)
(Ethernet)
(LoRaWAN)
(LoRaWAN Gateway)
(EtherCAT Slave)
(EtherCAT Master)

Do you have an your customer protocol?

See the following links:

www.adfweb.com?Product=HD67003

Do you need to choose a device? do you want help?

Ask it to the following link:

www.adfweb.com?Cmd=helpme



User Manual

INDEX:

	Page
INDEX	2
UPDATED DOCUMENTATION	2
REVISION LIST	2
WARNING	2
TRADEMARKS	2
SECURITY ALERT	3
EXAMPLE OF CONNECTION	4
CONNECTION SCHEME	5
CHARACTERISTICS	6
CONFIGURATION	6
POWER SUPPLY	7
FUNCTION MODES	8
LEDS	9
CAN	10
ETHERNET	11
USE OF COMPOSITOR SW67770	12
NEW PROJECT / OPEN PROJECT	13
SOFTWARE OPTIONS	14
SET COMMUNICATION	16
IEC61850 ACCESS	17
UPDATE DEVICE	23
MECHANICAL DIMENSIONS	25
ORDERING INFORMATIONS	26
ACCESSORIES	26
DISCLAIMER	27
OTHER REGULATIONS AND STANDARDS	27
WARRANTIES AND TECHNICAL SUPPORT	28
RETURN POLICY	28

UPDATED DOCUMENTATION:

Dear customer, we thank you for your attention and we remind you that you need to check that the following document is:

- ✚ Updated
- ✚ Related to the product you own

To obtain the most recently updated document, note the “document code” that appears at the top right-hand corner of each page of this document.

With this “Document Code” go to web page www.adfweb.com/download/ and search for the corresponding code on the page. Click on the proper “Document Code” and download the updates.

REVISION LIST:

Revision	Date	Author	Chapter	Description
1.000	14/03/2022	Ff	All	First release version

WARNING:

ADFweb.com reserves the right to change information in this manual about our product without warning.

ADFweb.com is not responsible for any error this manual may contain.

TRADEMARKS:

All trademarks mentioned in this document belong to their respective owners.

SECURITY ALERT:**GENERAL INFORMATION**

To ensure safe operation, the device must be operated according to the instructions in the manual. When using the device, legal and safety regulation are required for each individual application. The same applies also when using accessories.

INTENDED USE

Machines and systems must be designed so the faulty conditions do not lead to a dangerous situation for the operator (i.e. independent limit switches, mechanical interlocks, etc.).

QUALIFIED PERSONNEL

The device can be used only by qualified personnel, strictly in accordance with the specifications.

Qualified personnel are persons who are familiar with the installation, assembly, commissioning and operation of this equipment and who have appropriate qualifications for their job.

RESIDUAL RISKS

The device is state-of-the-art and is safe. The instruments can represent a potential hazard if they are inappropriately installed and operated by untrained personnel. These instructions refer to residual risks with the following symbol:



This symbol indicates that non-observance of the safety instructions is a danger for people that could lead to serious injury or death and / or the possibility of damage.

CE CONFORMITY

The declaration is made by our company. You can send an email to support@adfweb.com or give us a call if you need it.

EXAMPLE OF CONNECTION:

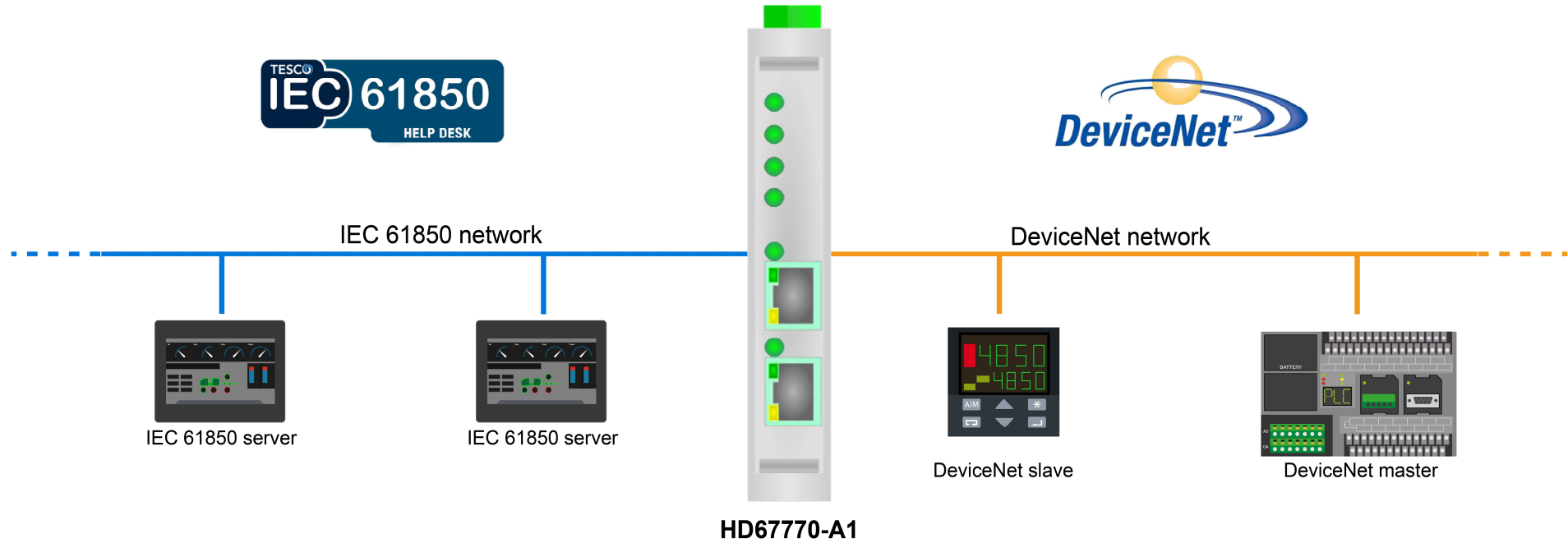

CONNECTION SCHEME:

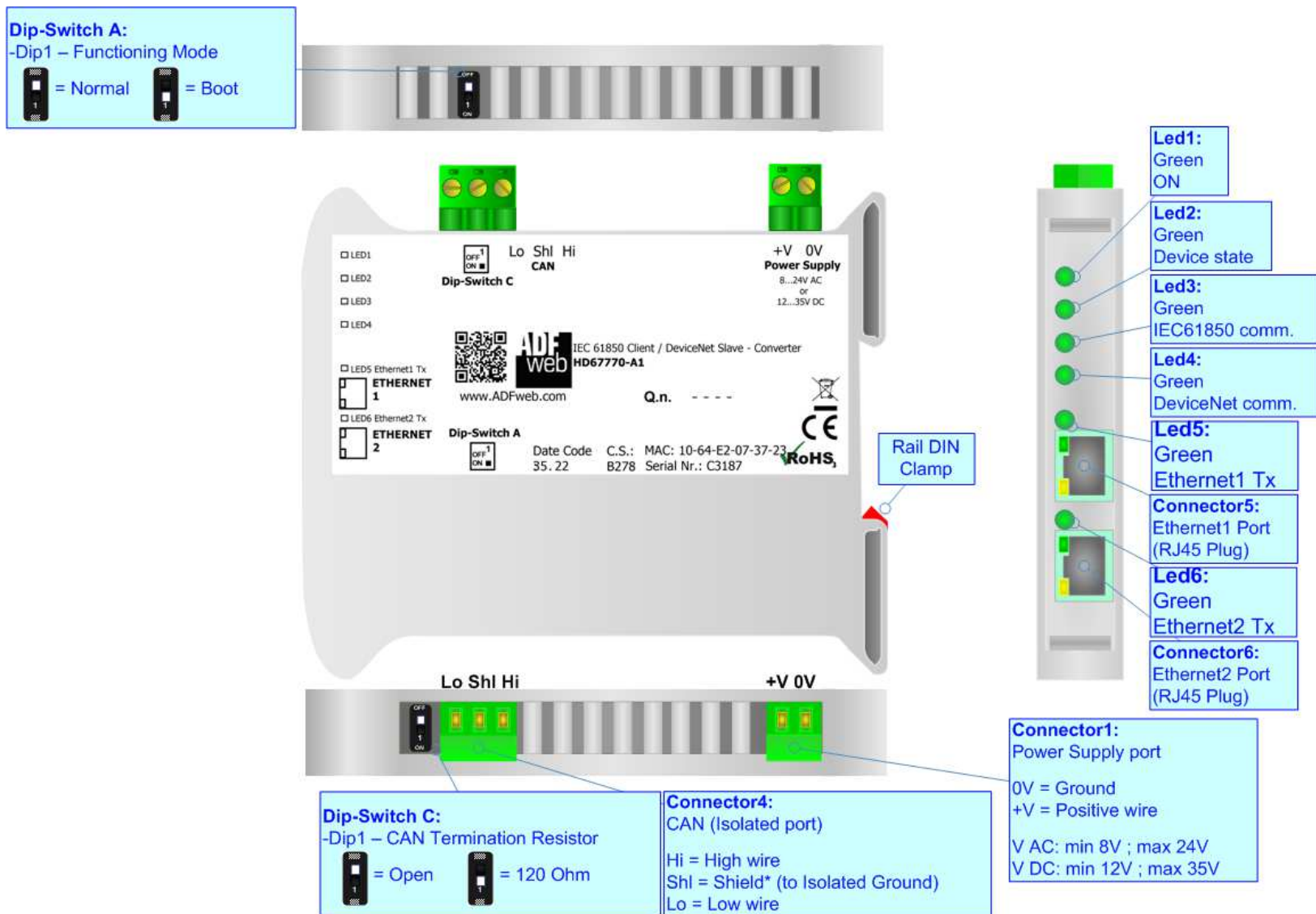

Figure 1: Connection scheme for HD67770-A1

CHARACTERISTICS:

The HD67770-A1 is a IEC61850 Client / DeviceNet Slave converter.

It allows the following characteristics:

- Up to 455 bytes in reading and 455 bytes in writing;
- Two-directional information between DeviceNet and IEC61850;
- Mountable on 35mm Rail DIN;
- Wide power supply input range: 8...24V AC or 12...35V DC;
- Wide temperature range: -40°C / 85°C [-40°F / +185°F].

CONFIGURATION:

You need Compositor SW67770 software on your PC in order to perform the following:

- Define the parameters of the IEC61850;
- Define the parameters of the DeviceNet;
- Define IEC61850 variables to be read by the DeviceNet Master;
- Define IEC61850 variables to be written by the DeviceNet Master;
- Update the device.

POWER SUPPLY:

The devices can be powered between a wide range of tensions. For more details see the two tables below.

	VAC		VDC	
	Vmin	Vmax	Vmin	Vmax
HD67770-A1	8V	24V	12V	35V

Consumption at 24V DC:

Device	W/VA
HD67770-A1	4



Caution: Not reverse the polarity power

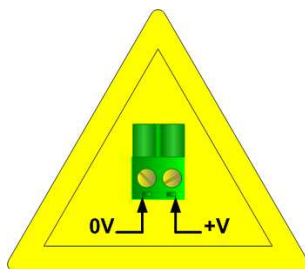

HD67770-A1

Connector1:
 Power Supply port
 0V = Ground
 +V = Positive wire
 V AC: min 8V ; max 24V
 V DC: min 12V ; max 35V

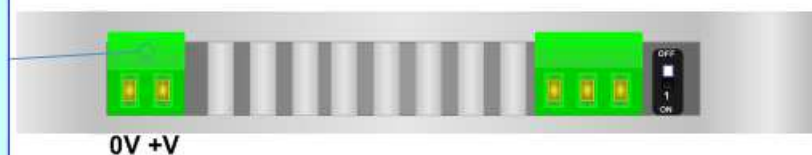

FUNCTION MODES:

The device has got two functions mode depending of the position of the Dip1 of 'Dip-Switch A':

- The first, with Dip1 in Off position (factory setting), is used for the normal working of the device.
- The second, with Dip1 in On position, is used for upload the Project/Firmware.

For the operations to follow for the updating (see 'UPDATE DEVICE' section).

According to the functioning mode, the LEDs will have specifics functions (see 'LEDS' section).



LEDS:

The device has got six LEDs that are used to give information of the functioning status. The various meanings of the LEDs are described in the table below.

LED	Normal Mode	Boot Mode
1: ON [supply voltage] (green)	ON: Device powered OFF: Device not powered	ON: Device powered OFF: Device not powered
2: Device State (green)	Blinks slowly (~1Hz)	Blinks quickly: Boot state Blinks very slowly (~0.5Hz): update in progress
3: IEC61850 comm. (green)	ON: At least one IEC61850 Server is disconnected Flashing: IEC61850 response OFF: No IEC61850 response	Blinks quickly: Boot state Blinks very slowly (~0.5Hz): update in progress
4: DeviceNet comm. (green)	Flashing: DeviceNet communication OFF: No DeviceNet communication	Blinks quickly: Boot state Blinks very slowly (~0.5Hz): update in progress
5: Ethernet1 Tx (green)	Blinks when is transmitting Ethernet frames	Blinks quickly: Boot state Blinks very slowly (~0.5Hz): update in progress
6: Ethernet2 Tx (green)	Blinks when is transmitting Ethernet frames	Blinks quickly: Boot state Blinks very slowly (~0.5Hz): update in progress

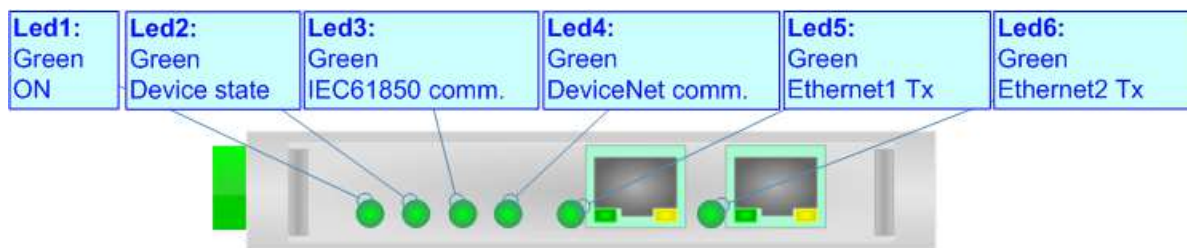

CAN:

For terminate the CAN line with a 120Ω resistor it is necessary that the Dip1 of 'Dip-Switch C' is at ON position.

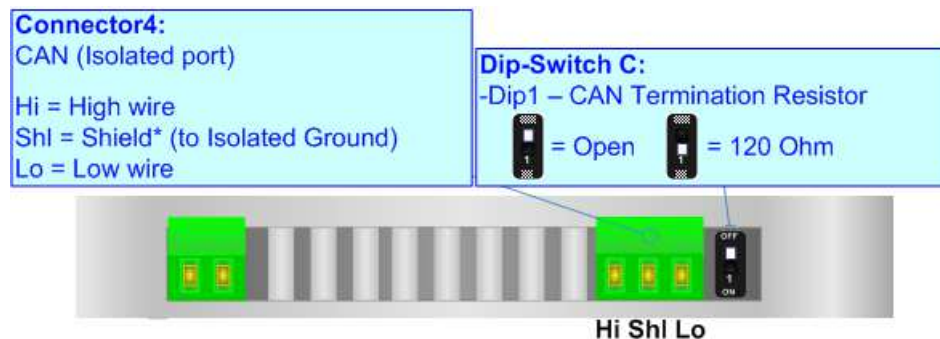

Cable characteristics:

DC parameter:	Impedance	70 Ohm/m
AC parameters:	Impedance	120 Ohm/m
	Delay	5 ns/m
Length	Baud Rate [bps]	Length MAX [m]
	10 K	5000
	20 K	2500
	50 K	1000
	100 K	650
	125 K	500
	250 K	250
	500 K	100
	800 K	50
	1000 K	25

ETHERNET:

The Ethernet connection must be made using Connector5 or Connector6 of HD67770-A1 with at least a Category 5E cable. The maximum length of the cable should not exceed 100m. The cable has to conform to the T568 norms relative to connections in cat.5 up to 100 Mbps. To connect the device to an Hub/Switch is recommended the use of a straight cable, to connect the device to a PC/PLC/other is recommended the use of a cross cable.

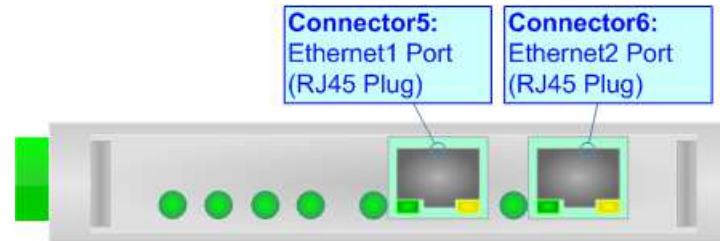

USE OF COMPOSITOR SW67770:

To configure the Converter, use the available software that runs with Windows called SW67770. It is downloadable on the site www.adfweb.com and its operation is described in this document. (*This manual is referenced to the last version of the software present on our web site*). The software works with MSWindows (XP, Vista, Seven, 8, 10, 11; 32/64bit).

When launching the SW67770, the window below appears (Fig. 2).

**Note:**

It is necessary to have installed .Net Framework 4.

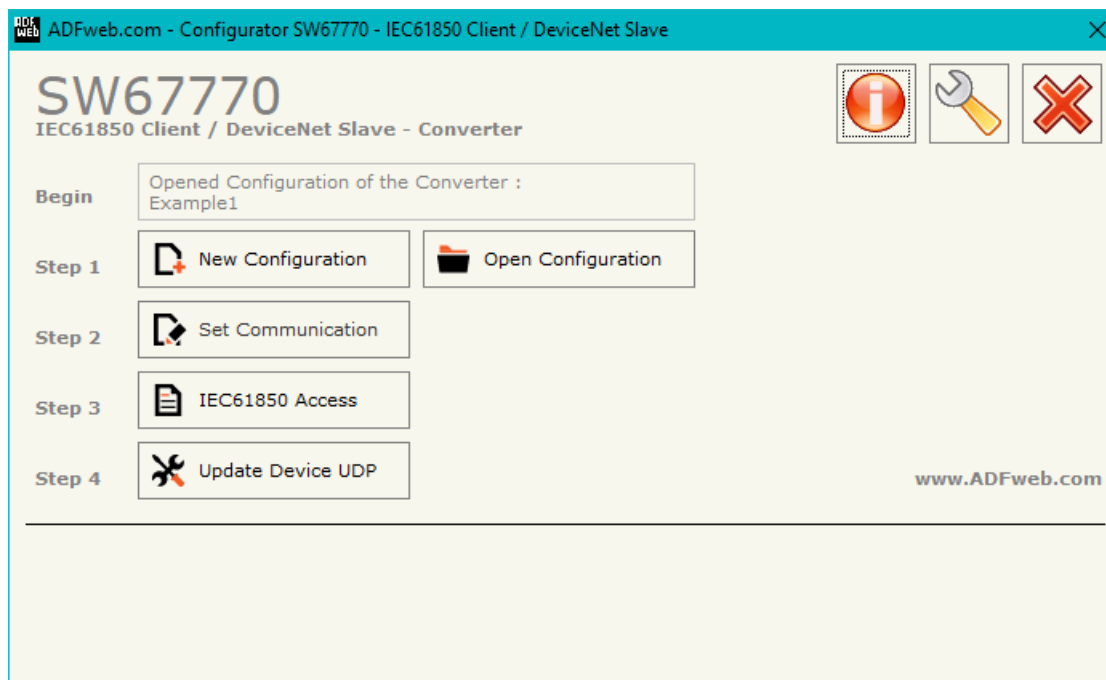
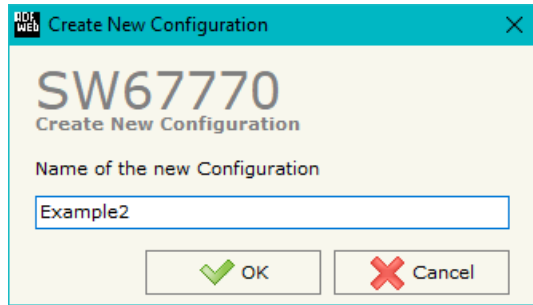

Figure 2: Main window for SW67770

NEW CONFIGURATION / OPEN CONFIGURATION:

The “**New Configuration**” button creates the folder which contains the entire device’s configuration.



A device’s configuration can also be imported or exported:

- To clone the configurations of a programmable “IEC61850 Client / DeviceNet Slave - Converter” in order to configure another device in the same manner, it is necessary to maintain the folder and all its contents;
- To clone a project in order to obtain a different version of the project, it is sufficient to duplicate the project folder with another name and open the new folder with the button “**Open Configuration**”.

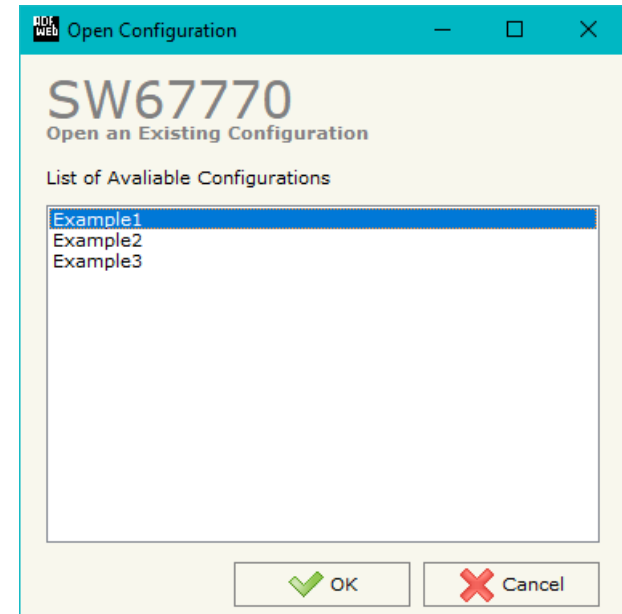

SOFTWARE OPTIONS:

By pressing the “**Settings**” () button there is the possibility to change the language of the software and check the updatings for the compositor.

In the section “Language” it is possible to change the language of the software.

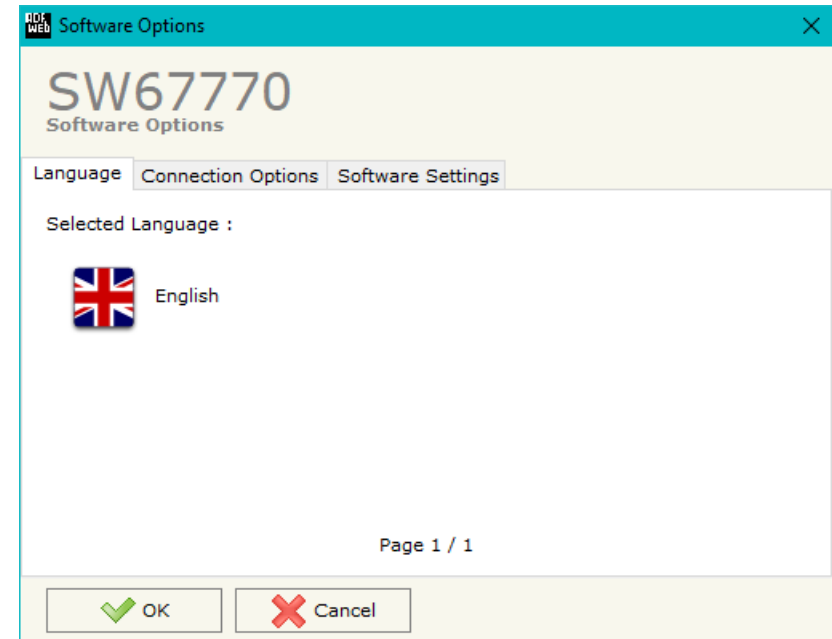
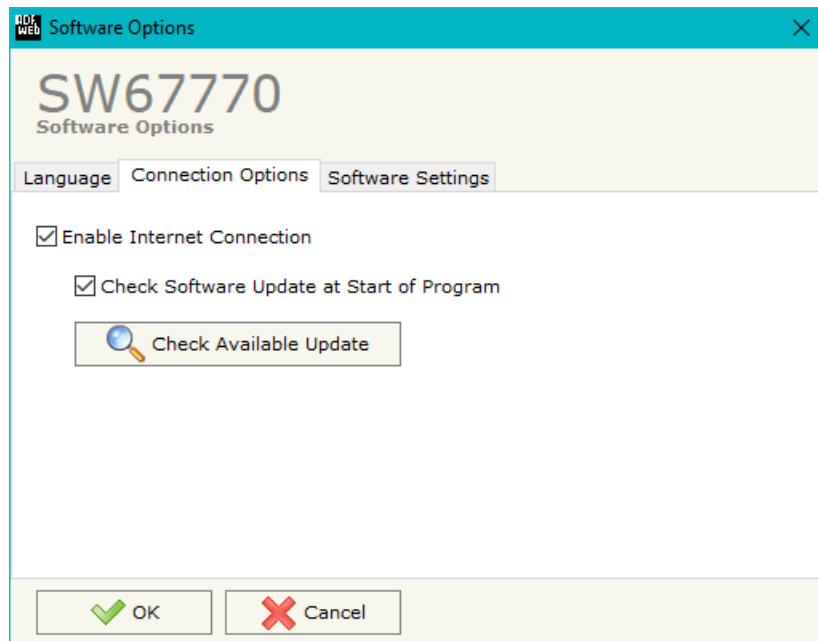

In the section “Connection Options”, it is possible to check if there are some updatings of the software compositor in ADFweb.com website. Checking the option “**Check Software Update at Start of Program**”, the SW67770 check automatically if there are updatings when it is launched.

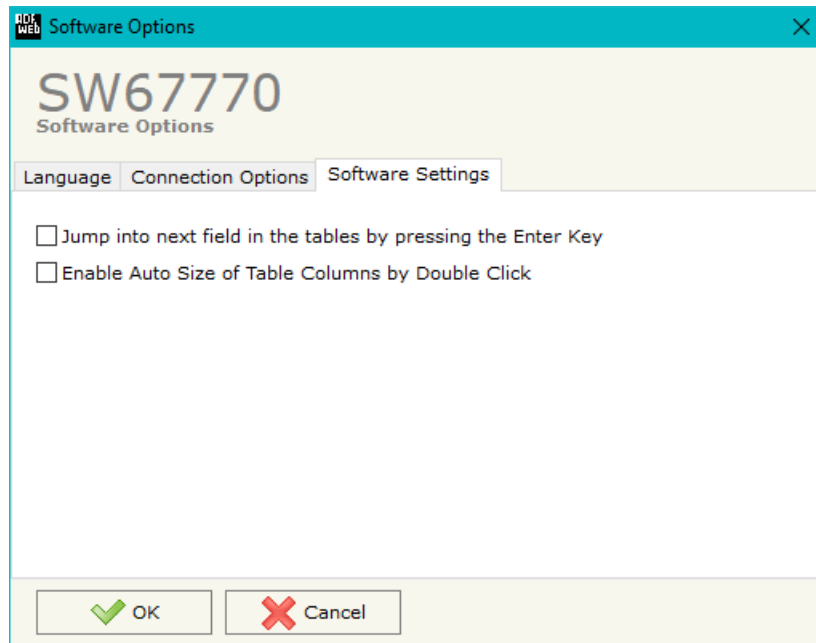

In the section "Software Settings", it is possible to enable/disable some keyboard's commands for an easier navigation inside the tables contained in the different sections of the software.

SET COMMUNICATION:

This section define the fundamental communication parameters of two buses, IEC61850 and DeviceNet.

By Pressing the **"Set Communication"** button from the main window for SW67770 (Fig. 2) the window "Set Communication" appears (Fig. 3).

The means of the fields for "IEC61850 Client" are:

- In the fields **"IP Address"** the IP address for IEC61850 side of the converter is defined;
- In the fields **"SubNet Mask"** the SubNet Mask for IEC61850 side of the converter is defined;
- In the fields **"Gateway"** the default gateway of the net is defined. This feature can be enabled or disabled pressing the Check Box field. This feature is used for going out of the net;
- In the field **"VLAN"** the identifier for the VLAN is defined;
- In the field **"Application ID"** the Goose identification string is defined.

The means of the fields for "DeviceNet Slave" are:

- In the field **"ID Device"** the ID of DeviceNet side of the converter is defined;
- In the field **"Baudrate"** the data rate of the DeviceNet bus is defined;
- In the field **"Number Byte Input"** the number of input byte of the slave station is defined;
- In the field **"Number Byte Output"** the number of output byte of the slave station is defined.

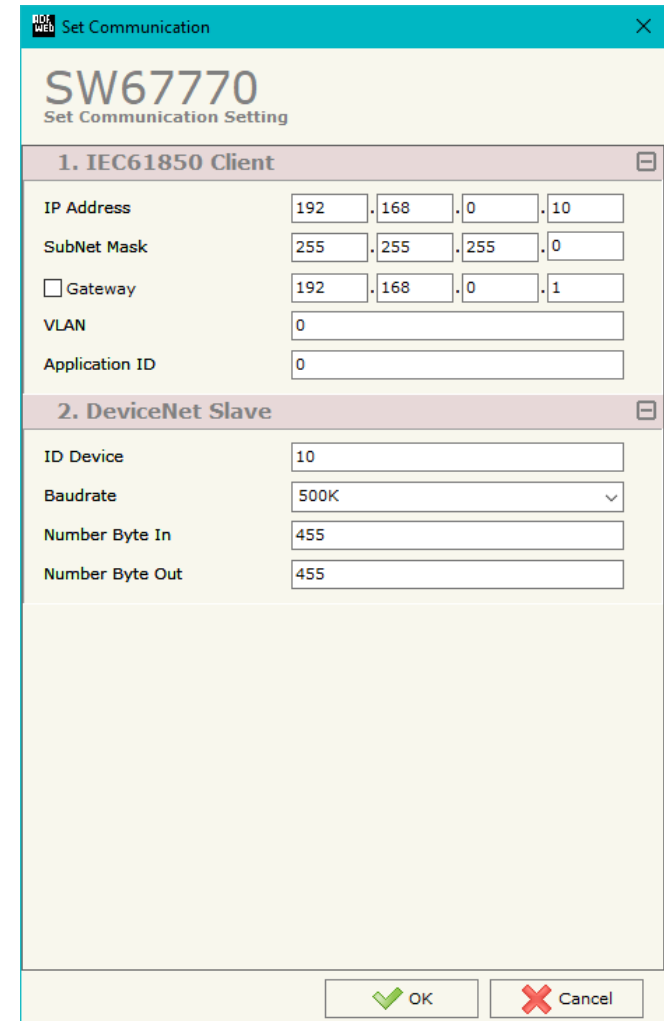

1. IEC61850 Client	
IP Address	192 . 168 . 0 . 10
SubNet Mask	255 . 255 . 255 . 0
<input checked="" type="checkbox"/> Gateway	192 . 168 . 0 . 1
VLAN	0
Application ID	0
2. DeviceNet Slave	
ID Device	10
Baudrate	500K
Number Byte In	455
Number Byte Out	455

Figure 3: "Set Communication" window

IEC61850 ACCESS:

By Pressing the “**IEC61850 Access**” button from the main window for SW67770 (Fig. 2) the window “IEC61850 Client Set Access” appears (Fig. 4).

This section is used to define the list of IEC61850 variables from/to which take/map the data of EtherNet/IP.

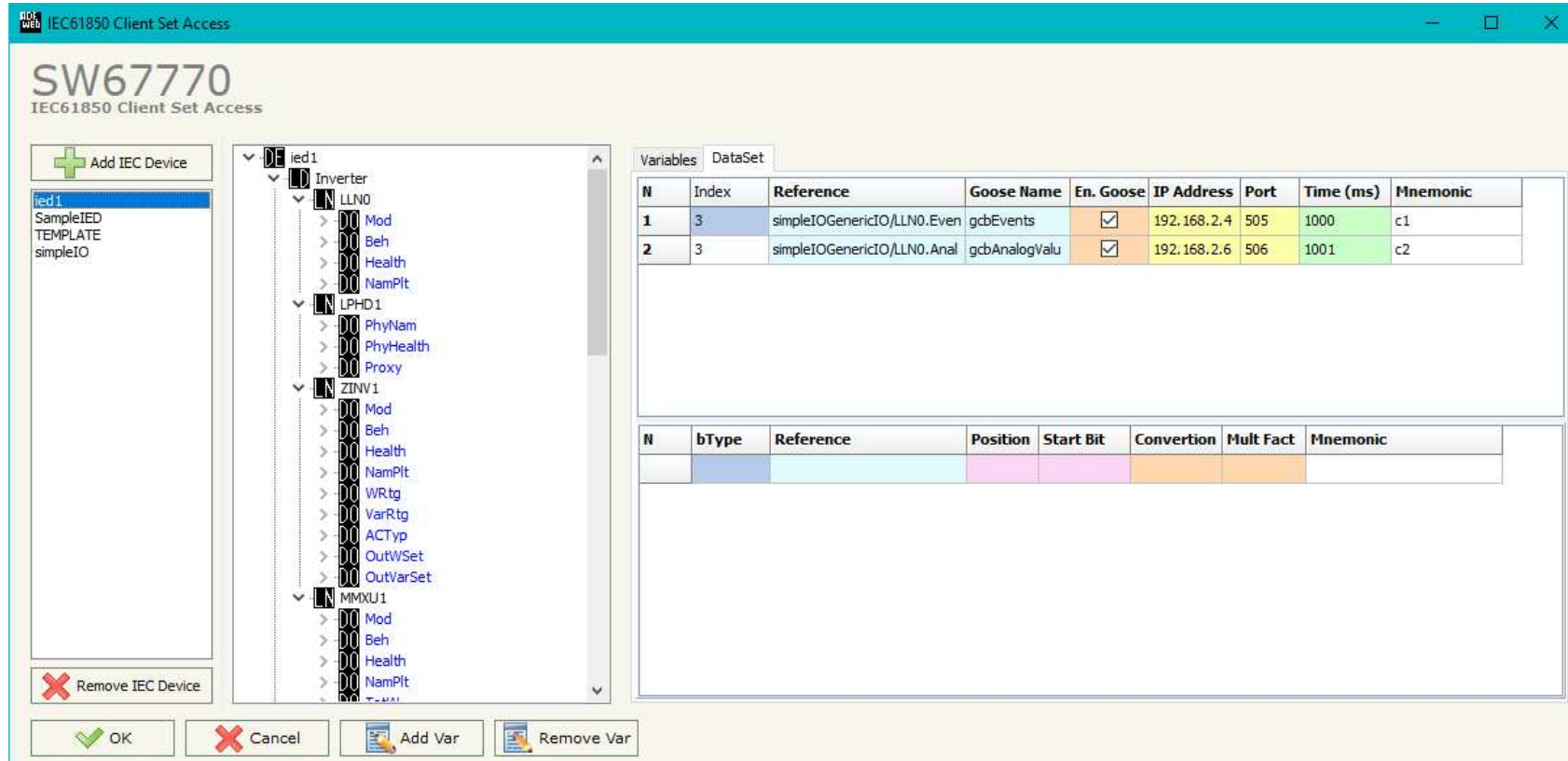

Figure 4: “IEC61850 Client Set Access” window

By clicking on “**ADD IEC Device**”, it is possible to add a new IEC61850 Server. A SCL file has to be selected (the allowed extensions are .scd, .ssd, .sed, .icd, .iid or .cid). The functional structure of the Server (Logical Devices, Logical Nodes, Data Objects and Data Attributes) will be visible (Fig. 5). The last leaves in the branches of the structure are the variables which can be added to the “Variables” section on the right (Fig. 6).

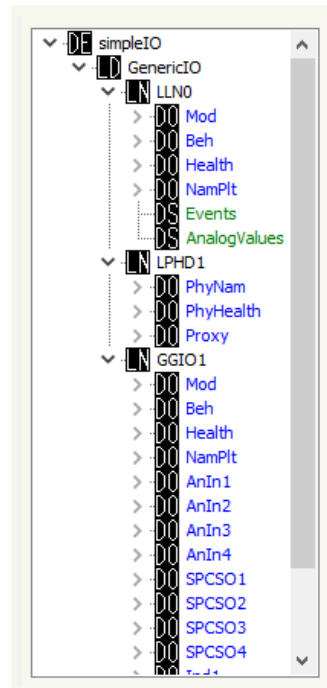

Figure 5: functional structure

Variables		DataSet														
N	Index	bType	fc	Reference	IP Address	Port	On Change	On CMD	On Timer	Time (ms)	Position	Start Bit	R/W	Conversion	Molt Fact	Mnemonic
1	0	FLOAT32	MX	simpleIOGenericIO/GGIO1.AnIn1.mag.f	192.168.2.37	102	<input type="checkbox"/>	<input type="checkbox"/>	<input checked="" type="checkbox"/>	1000	0	0	Read	None	0	
2	0	FLOAT32	MX	simpleIOGenericIO/GGIO1.AnIn2.mag.f	192.168.2.37	102	<input type="checkbox"/>	<input type="checkbox"/>	<input checked="" type="checkbox"/>	1000	4	0	Read	None	0	
3	0	FLOAT32	MX	simpleIOGenericIO/GGIO1.AnIn3.mag.f	192.168.2.37	102	<input type="checkbox"/>	<input type="checkbox"/>	<input checked="" type="checkbox"/>	1000	8	0	Read	ItoF/FtoI	100	
4	0	FLOAT32	MX	simpleIOGenericIO/GGIO1.AnIn4.mag.f	192.168.2.37	102	<input type="checkbox"/>	<input type="checkbox"/>	<input checked="" type="checkbox"/>	1000	12	0	Read	ItoF/FtoI	100	

Figure 6: "Variables" section

The meanings of the fields are:

- In the field "**Index**" the index of the server to which the IEC61850 variable belongs is defined;
- In the field "**bType**" the data format of the IEC61850 variable is defined;
- In the field "**fc**" the Functional Constraint of the IEC61850 variable is defined;
- In the field "**Reference**" the path of the IEC61850 variable is defined;
- In the field "**IP Address**" the IP Address of the server to which the IEC61850 variable belongs is defined;
- In the field "**Port**" the Port of the server to which the IEC61850 variable belongs is defined;
- If the field "**On Change**" is checked, the IEC61850 variable is sent when the data on DeviceNet changes the value (only in write);
- If the field "**On Timer**" is checked, the IEC61850 variable is sent/read cyclically;

- In the field "**Time (ms)**" the delay in ms between two readings/writings of the variable is defined (if "On Timer" is checked);
- In the field "**Position**" the starting byte of the EtherNet/IP arrays where saving/getting the value is defined;
- In the field "**Start Bit**" the starting bit of the byte of the field "Position" is defined (only for BOOLEAN data);
- In the field "**R/W**" the access type of the IEC61850 variable is defined;
- In the field "**Conversion**" the type of conversion of the value is defined (only for FLOAT32/FLOAT64 data);
- In the field "**Molt Fact**" the multiplication factor for the conversion is defined (if "Conversion" is defined as "ItoF/FtoI");
- In the field "**Mnemonic**" a description of the variable is defined.

**Note:**

Not all variables can be written. It depends on their Functional Constraints (fc).

If they are available in the functional structure, it is also possible to add Datasets (DS) to "DataSet" section (Fig. 7).

Variables		DataSet						
N	Index	Reference	Goose Name	En. Goose	IP Address	Port	Time (ms)	Mnemonic
1	0	simpleIOGenericIO/LLN0.Events	gcbEvents	<input type="checkbox"/>	192.168.2.37	103	5000	

N	bType	Reference	Position	Start Bit	Conversion	Mult Fact	Mnemonic
1	BOOLEAN	simpleIOGenericIO/GGIO1.SPCSO1.stVal	10	0	None	0	
2	BOOLEAN	simpleIOGenericIO/GGIO1.SPCSO2.stVal	10	1	None	0	
3	BOOLEAN	simpleIOGenericIO/GGIO1.SPCSO3.stVal	10	2	None	0	
4	BOOLEAN	simpleIOGenericIO/GGIO1.SPCSO4.stVal	10	3	None	0	

Figure 7: "DataSet" section

In the upper part, there are all the inserted Datasets. The meanings of the fields are:

- In the field "**Index**" the index of the server to which the IEC61850 Dataset belongs is defined;
- In the field "**Reference**" the path of the IEC61850 Dataset is defined;
- In the field "**Goose Name**" the Goose Name of the IEC61850 Dataset is defined (if "En. Goose" is checked);
- If the field "**En. Goose**" is checked, the Dataset is received as a Goose message;
- In the field "**IP Address**" the IP Address of the server to which the Dataset belongs is defined (if "En. Goose" is unchecked);
- In the field "**Port**" the Port of the server to which the Dataset belongs is defined (if "En. Goose" is unchecked);
- In the field "**Time (ms)**" the delay in ms between two readings of the Dataset is defined (if "En. Goose" is unchecked);
- In the field "**Mnemonic**" a description of the Dataset is defined.

In the lower part, it is possible to see the variables which belong to the selected Dataset. The meanings of the fields are:

- In the field "**bType**" the data format of the IEC61850 variable is defined;
- In the field "**Reference**" the path of the IEC61850 variable is defined;
- In the field "**Position**" the starting byte of the DeviceNet arrays where saving/getting the value is defined;
- In the field "**Start Bit**" the starting bit of the byte of the field "Position" is defined (only for BOOLEAN data);
- In the field "**Conversion**" the type of conversion of the value is defined (only for FLOAT32/FLOAT64 data);
- In the field "**Molt Fact**" the multiplication factor for the conversion is defined (if "Conversion" is defined as "ItoF/FtoI");
- In the field "**Mnemonic**" a description of the variable is defined.



Note:

The variables of a IEC61850 Dataset can only be read.

UPDATE DEVICE:

By pressing the **“Update Device”** button, it is possible to load the created Configuration into the device; and also the Firmware, if necessary. This by using the Ethernet port.

If you don't know the actual IP address of the device you have to use this procedure:

- Turn OFF the Device;
- Put Dip1 of 'Dip-Switch A' in ON position;
- Turn ON the device
- Connect the Ethernet cable;
- Insert the IP **“192.168.2.205”**;
- Select which operations you want to do;
- Press the **“Execute update firmware”** button to start the upload;
- When all the operations are “OK” turn OFF the Device;
- Put Dip1 of 'Dip-Switch A' in OFF position;
- Turn ON the device.

If you know the actual IP address of the device, you have to use this procedure:

- Turn ON the Device with the Ethernet cable inserted;
- Insert the actual IP of the Converter;
- Select which operations you want to do;
- Press the **“Execute update firmware”** button to start the upload;
- When all the operations are “OK” the device automatically goes at Normal Mode.

At this point the configuration/firmware on the device is correctly updated.

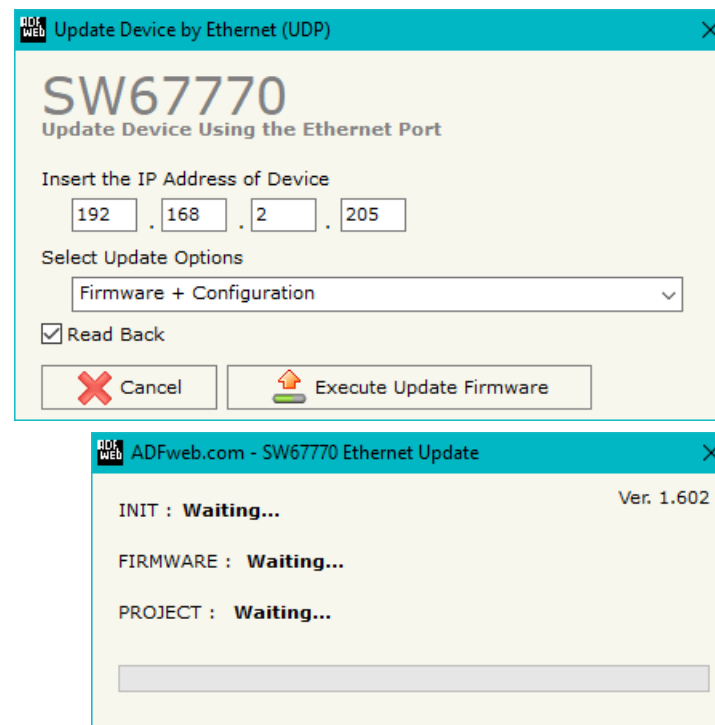

Figure 8: “Update device” windows



Note:

When you receive the device, for the first time, you also have to update the Firmware in the HD67770 device.



Warning:

If Fig. 9 appears when you try to do the Update try these points before seeking assistance:

- Try to repeat the operations for the updating;
- Try with another PC;
- Try to restart the PC;
- Check the LAN settings;
- If you are using the program inside a Virtual Machine, try to use in the main Operating System;
- If you are using Windows Seven, Vista, 8, 10 or 11 make sure that you have the administrator privileges;
- In case you have to program more than one device, using the "UDP Update", you have to cancel the ARP table every time you connect a new device on Ethernet. For do this you have to launch the "Command Prompt" and write the command "arp -d". Pay attention that with Windows Vista, Seven, 8, 10, 11 you have to launch the "Command Prompt" with Administrator Rights;
- Pay attention at Firewall lock.



Warning:

In the case of HD67770 you have to use the software "SW67770": www.adfweb.com/download/filefold/SW67770.zip.

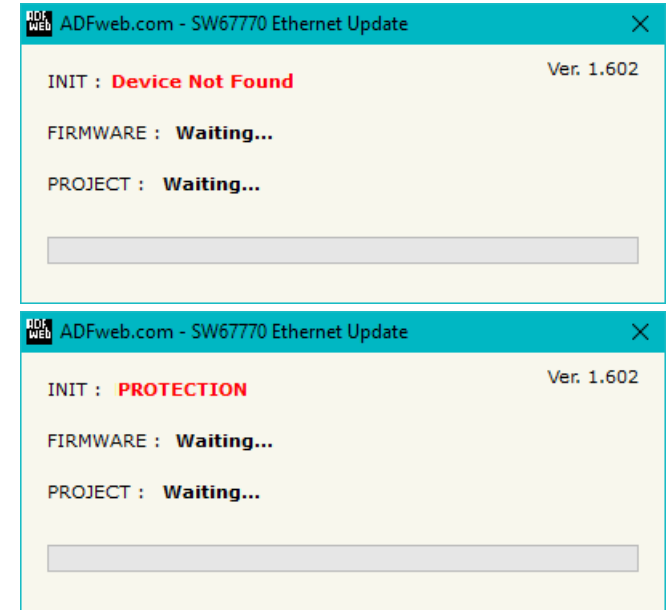

Figure 9: "Error" windows

MECHANICAL DIMENSIONS:

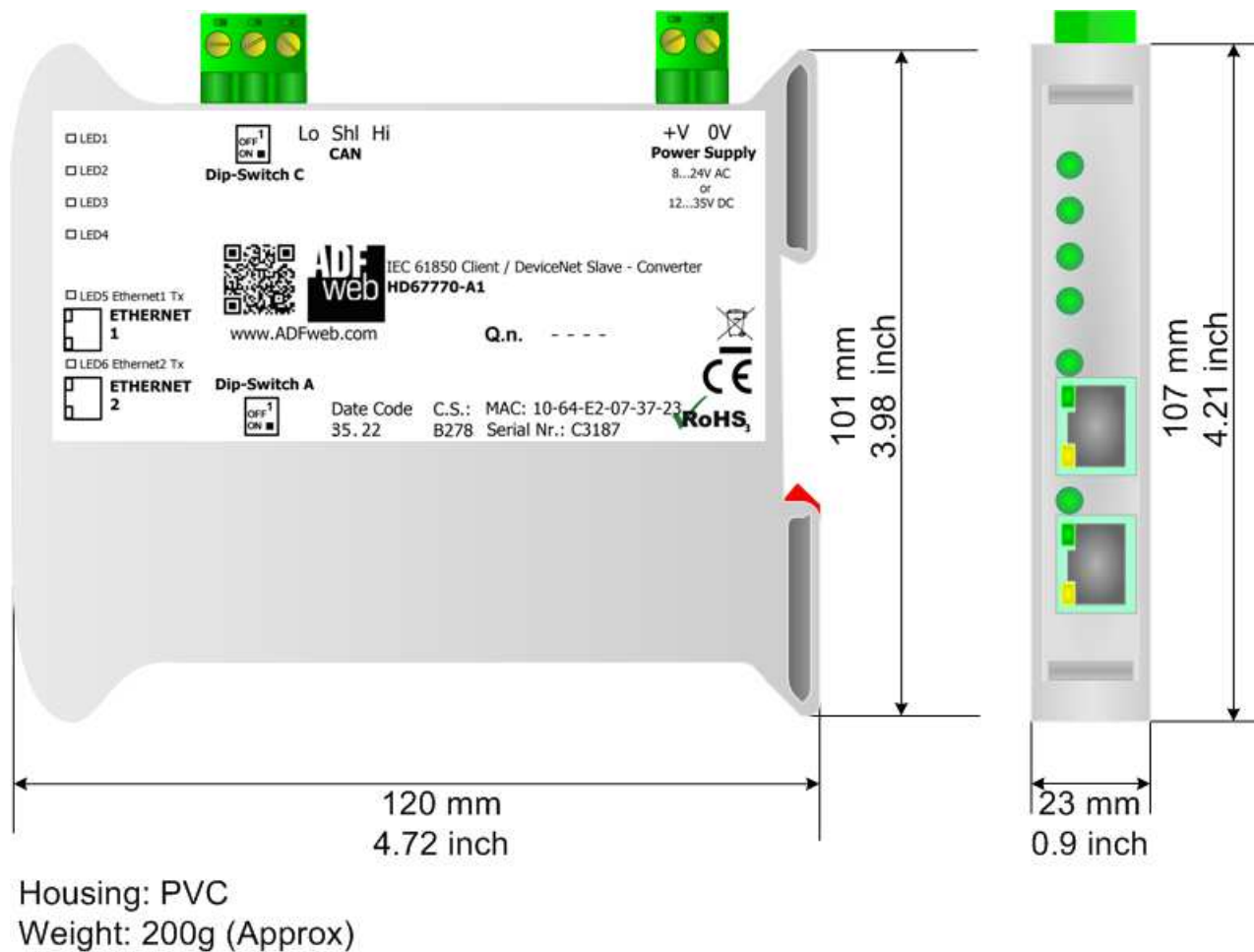
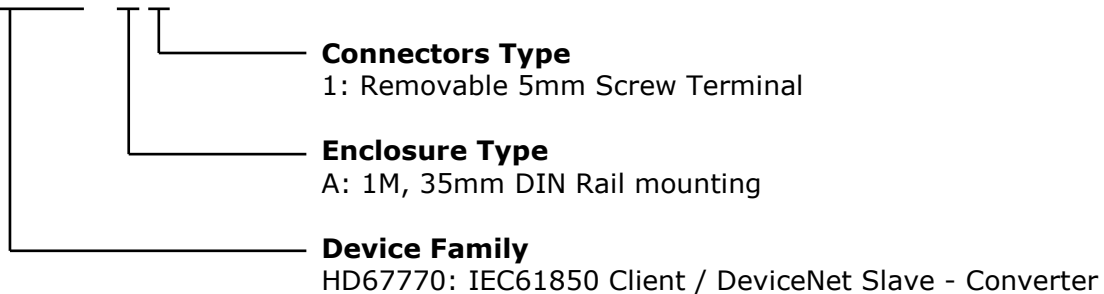

Figure 10: Mechanical dimensions scheme for HD67770-A1

ORDERING INFORMATIONS:

The ordering part number is formed by a valid combination of the following:

HD67770 - A 1

Order Code: **HD67770-A1** - IEC61850 Client / DeviceNet Slave - Converter

ACCESSORIES:

Order Code: **AC34011** - Rail DIN - Power Supply 220/240V AC 50/60Hz - 12 V DC

Order Code: **AC34012** - Rail DIN - Power Supply 220/240V AC 50/60Hz - 24 V DC

DISCLAIMER:

All technical content within this document can be modified without notice. The content of the document is a under continual renewal. For losses due to fire, earthquake, third party access or other accidents, or intentional or accidental abuse, misuse, or use under abnormal conditions repairs are charged to the user. ADFweb.com S.r.l. will not be liable for accidental loss of use or inability to use this product, such as loss of business income. ADFweb.com S.r.l. shall not be liable for consequences of improper use.

OTHER REGULATIONS AND STANDARDS:**WEEE INFORMATION**

Disposal of old electrical and electronic equipment (as in the European Union and other European countries with separate collection systems).

— This symbol on the product or on its packaging indicates that this product may not be treated as household rubbish. Instead, it should be taken to an applicable collection point for the recycling of electrical and electronic equipment. If the product is disposed correctly, you will help prevent potential negative environmental factors and impact of human health, which could otherwise be caused by inappropriate disposal. The recycling of materials will help to conserve natural resources. For more information about recycling this product, please contact your local city office, your household waste disposal service or the shop where you purchased the product.

RESTRICTION OF HAZARDOUS SUBSTANCES DIRECTIVE

The device respects the 2002/95/EC Directive on the restriction of the use of certain hazardous substances in electrical and electronic equipment (commonly referred to as Restriction of Hazardous Substances Directive or RoHS).

CE MARKING

The product conforms with the essential requirements of the applicable EC directives.

WARRANTIES AND TECHNICAL SUPPORT:

For fast and easy technical support for your ADFweb.com SRL products, consult our internet support at www.adfweb.com.
Otherwise contact us at the address support@adfweb.com

RETURN POLICY:

If while using your product you have any problem and you wish to exchange or repair it, please do the following:

- Obtain a Product Return Number (PRN) from our internet support at www.adfweb.com. Together with the request, you need to provide detailed information about the problem.
- Send the product to the address provided with the PRN, having prepaid the shipping costs (shipment costs billed to us will not be accepted).

If the product is within the warranty of twelve months, it will be repaired or exchanged and returned within three weeks. If the product is no longer under warranty, you will receive a repair estimate.



ADFweb.com S.r.l.
Via Strada Nuova, 17
IT-31010 Mareno di Piave
TREVISO (Italy)
Phone +39.0438.30.91.31
Fax +39.0438.49.20.99
www.adfweb.com

