

User Manual

Revision 1.003
English

J1939 / Modbus Master - Converter

(Order Code: HD67050 – HD67050M)

for Website information:

www.adfweb.com?Product=HD67050

for Price information:

www.adfweb.com?Price=HD67050

www.adfweb.com=Price=HD67050M

Benefits and Main Features:

- ▶ Very easy to configure
- ▶ Low cost
- ▶ Modbus RTU on Serial RS232/485
- ▶ RS232/485 selection
- ▶ Galvanic isolation
- ▶ Industrial temperature range:
-40°C / 85°C (-40°F / 185°F)



HD67050



HD67050M

Similar Products



For others Gateways / Bridges:

J1939 to Modbus

See also the following links:

www.adfweb.com?Product=HD67215 (Modbus TCP)

CANopen to Modbus

See also the following links:

www.adfweb.com?Product=HD67001 (Modbus RTU Master)

www.adfweb.com?Product=HD67002 (Modbus RTU Slave)

www.adfweb.com?Product=HD67004 (Modbus TCP Master)

www.adfweb.com?Product=HD67505 (Modbus TCP Slave)

For others Gateways / Bridges:

For **CAN bus 2.0A** and/or **CAN bus 2.0B** to **Modbus**

See also the following links:

www.adfweb.com?Product=HD67011 (Modbus RTU Slave)

www.adfweb.com?Product=HD67012 (Modbus RTU Master)

www.adfweb.com?Product=HD67014 (Modbus TCP Slave)

www.adfweb.com?Product=HD67515 (Modbus TCP Master)

Do you have an your customer protocol?

See the following links:

www.adfweb.com?Product=HD67003

Do you need to choose a device? do you want help?

Ask it to the following link:

www.adfweb.com?Cmd=helpme

Benefit



INDEX:

	Page
INDEX	2
UPDATED DOCUMENTATION	2
REVISION LIST	2
WARNING	2
TRADEMARKS	2
SECURITY ALERT	3
CONNECTION SCHEME	4
CHARACTERISTICS	6
CONFIGURATION	6
POWER SUPPLY	7
FUNCTION MODES	8
LEDS	9
RS485	10
J1939	11
RS232	12
USE OF COMPOSITOR SW67050	13
NEW PROJECT / OPEN PROJECT	13
SET COMMUNICATION	14
FRAME J1939	15
DEFINE J1939	16
SETTING GROUP	17
UPDATE DEVICE	18
MECHANICAL DIMENSIONS	20
ORDER CODE	20
ACCESSORIES	20
DISCLAIMER	21
OTHER REGULATIONS AND STANDARDS	21
WARRANTIES AND TECHNICAL SUPPORT	22
RETURN POLICY	22
PRODUCTS AND RELATED DOCUMENTS	22

UPDATED DOCUMENTATION:

Dear customer, we thank you for your attention and we remind you that you need to check that the following document is:

- Updated
- Related to the product you own

To obtain the most recently updated document, note the "document code" that appears at the top right-hand corner of each page of this document.

With this "Document Code" go to web page www.adfweb.com/download/ and search for the corresponding code on the page. Click on the proper "Document Code" and download the updates.

To obtain the updated documentation for the product that you own, note the "Document Code" (Abbreviated written "Doc. Code" on the label on the product) and download the updated from our web site www.adfweb.com/download/

REVISION LIST:

Revision	Date	Author	Chapter	Description
1.000	23/01/2009	Fl	All	First release version
1.001	21/07/2010	Fl	All	Revision
1.002	01/02/2012	Fl	All	Revision
1.003	18/02/2013	Nt	All	Added new chapters

WARNING:

ADFweb.com reserves the right to change information in this manual about our product without warning.
ADFweb.com is not responsible for any error this manual may contain.

TRADEMARKS:

All trademarks mentioned in this document belong to their respective owners.

SECURITY ALERT:**GENERAL INFORMATION**

To ensure safe operation, the device must be operated according to the instructions in the manual. When using the device are required for each individual application, legal and safety regulation. The same applies also when using accessories.

INTENDED USE

Machines and systems must be designed so the faulty conditions do not lead to a dangerous situation for the operator (i.e. independent limit switches, mechanical interlocks, etc.).

QUALIFIED PERSONNEL

The device can be used only by qualified personnel, strictly in accordance with the specifications.

Qualified personnel are persons who are familiar with the installation, assembly, commissioning and operation of this equipment and who have appropriate qualifications for their job.

RESIDUAL RISKS

The device is state of the art and is safe. The instrument can represent a potential hazard if they are inappropriately installed and operated by personnel untrained. These instructions refer to residual risks with the following symbol:

 This symbol indicates that non-observance of the safety instructions is danger for people to serious injury or death and / or the possibility of damage.

CE CONFORMITY

The declaration is made by us. You can send an email to support@adfweb.com or give us a call if you need it.

CONNECTION SCHEME:

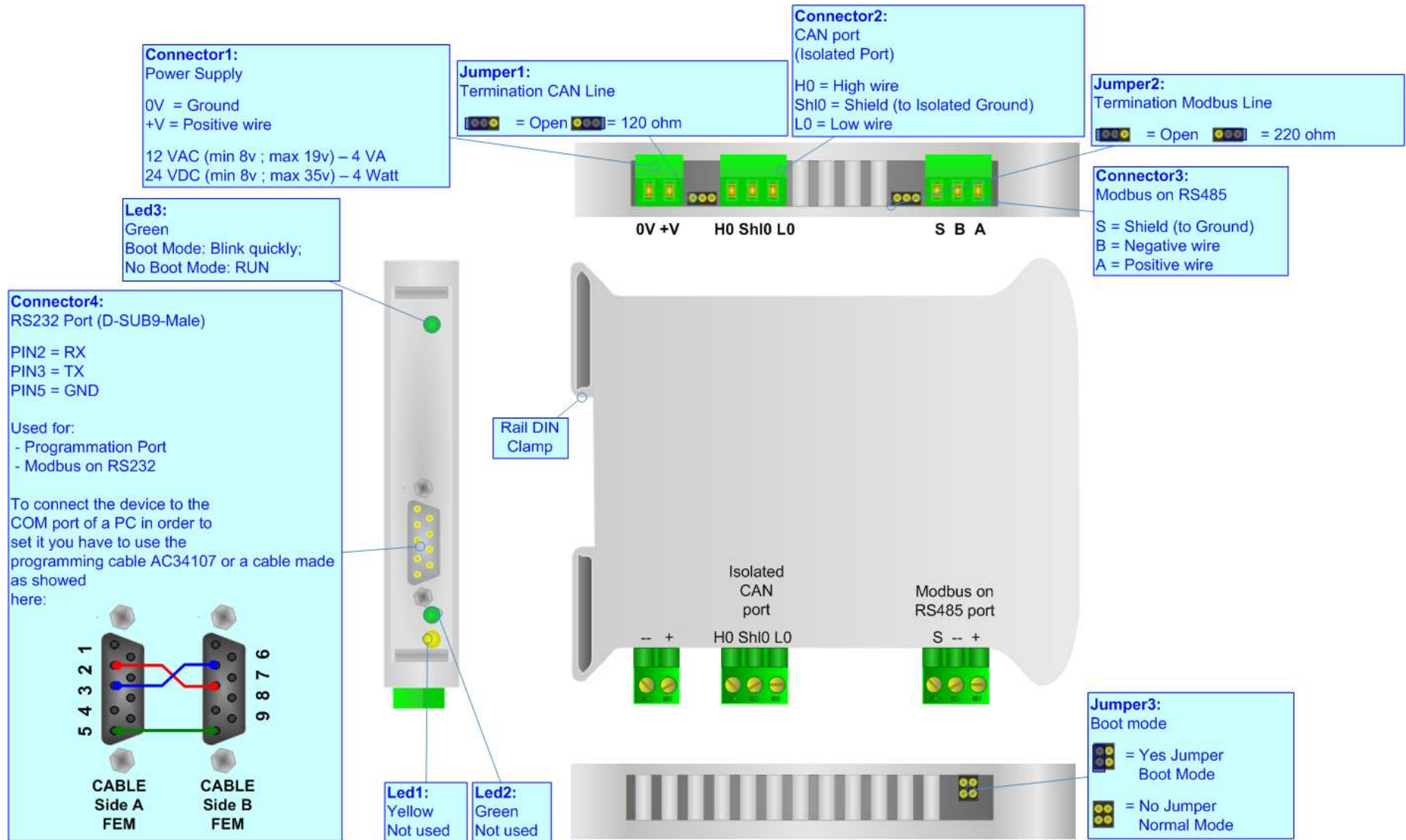

Figure 1: Connection scheme for HD67050

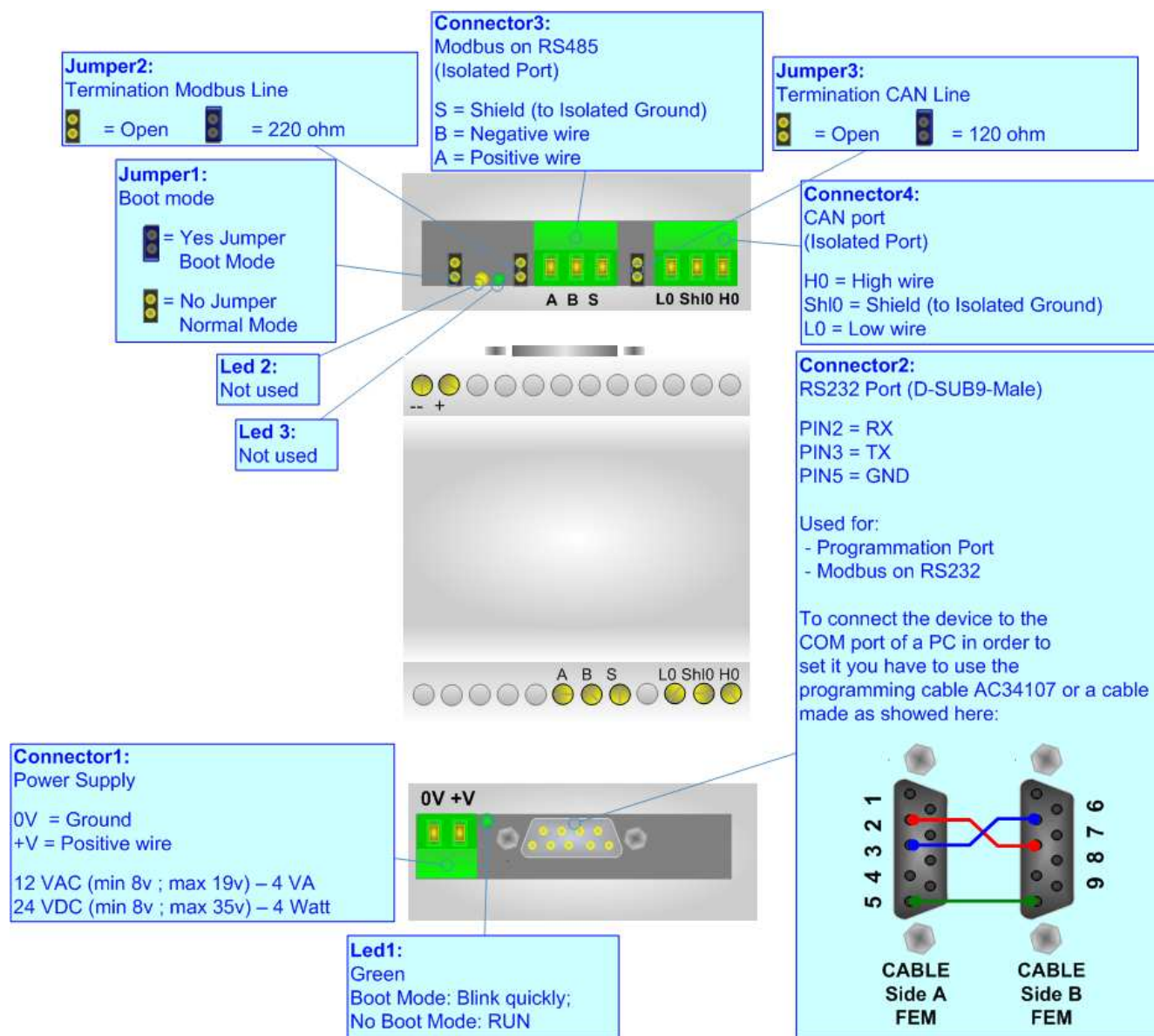

Figure 2: Connection scheme for HD67050M

CHARACTERISTICS:

The configurable J1939 from/to Modbus Master gateway allow the following:

- Baud rate changeable with software;
- Electrical isolation between two buses;
- It allows to read, through J1939 frames, the data that the Gateway ask to Modbus devices;
- Power supply of 8...19 VAC 4VA or 8...35 VDC 4W;
- 35mm Rail DIN mounting;
- Temperature range -40°C to 85°C.

CONFIGURATION:

The "Gateway J1939 into Modbus", allows a J1939 network to communicate with a Modbus network.

You need Compositor SW67050 software on your PC in order to perform the following:

- Define the communication parameters of two lines;
- Define the J1939 frames;
- Define which Modbus Registers read;
- Update the Firmware and/or Project.

POWER SUPPLY:

The devices can be powered between a wide range of tensions. For more details see the two tables below.

	VAC		VDC	
	Vmin	Vmax	Vmin	Vmax
HD67050	8V	19V	8V	35V
HD67050M	8V	19V	8V	35V

Consumption at 24V DC:

Device	W/VA
HD67050	4
HD67050M	4



Caution: Not reverse the polarity power

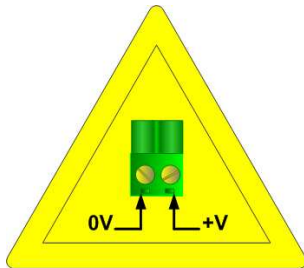

HD67050

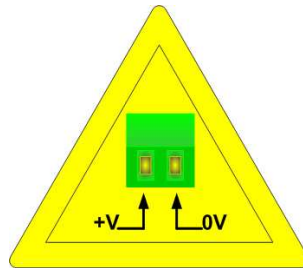

HD67050M

Connector1:
Power Supply
0V = Ground
+V = Positive wire
V AC: min 8V ; max 19v
V DC: min 8v ; max 35v

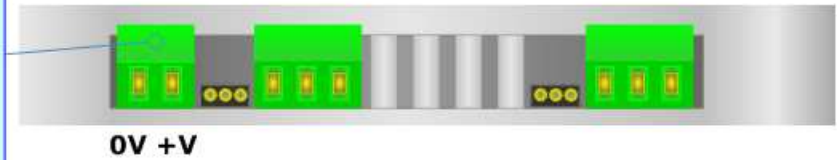

Connector1:
Power Supply
0V = Ground
+V = Positive wire
V AC: min 8V ; max 19v
V DC: min 8v ; max 35v

FUNCTION MODES:

The device has got two functions mode depending of the position of the 'Jumper3' of HD67050 or 'Jumper1' of HD67050M:

- The first, without any jumper inserted, is used for the normal working of the device.
- The second, with the jumper inserted, is used for upload the Project.

For the operations to follow for the updating (see 'UPDATE DEVICE' section).

According to the functioning mode, the LEDs will have specifics functions (see 'LEDS' section).

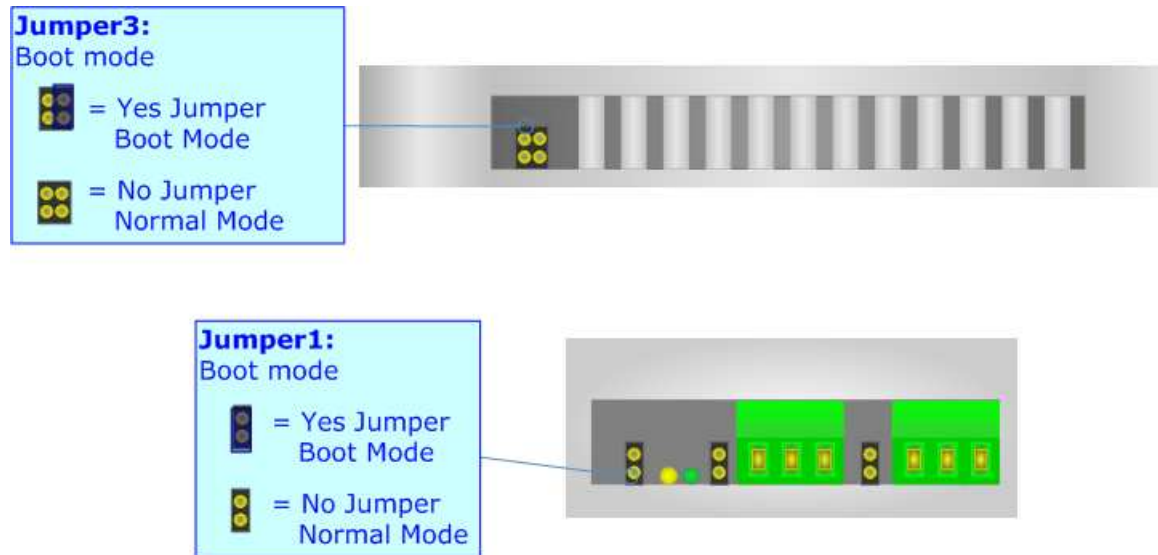

LEDS:

The device has got three LEDs that are used to give information of the functioning status. The various meanings of the LEDs are described in the table below.

HD67050

LED	Normal Mode	Boot Mode
1	Off	Off
2	Off	Off
3	Blinks slowly (~1Hz)	Blinks quickly

HD67050M

LED	Normal Mode	Boot Mode
1	Blinks slowly (~1Hz)	Blinks quickly
2	Off	Off
3	Off	Off

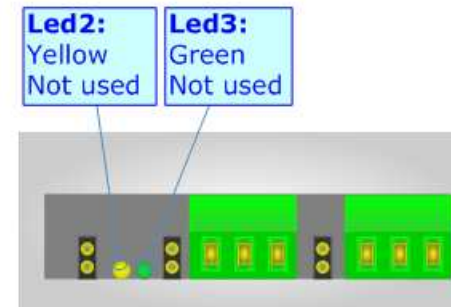

RS485:

For terminate the RS485 line with a 220Ω resistor it is necessary to insert the 'Jumper2' like in figure.

The maximum length of the cable should be 1200m (4000 feet).

Here some codes of cables:

- Belden: p/n 8132 - 2x 28AWG stranded twisted pairs conductor + foil shield + braid shield;
- Belden p/n 82842 - 2x 24AWG stranded twisted pairs conductor + foil shield + braid shield;
- Tasker: p/n C521 - 1x 24AWG twisted pair conductor + foil shield + braid shield;
- Tasker: p/n C522 - 2x 24AWG twisted pairs conductor + foil shield + braid shield.

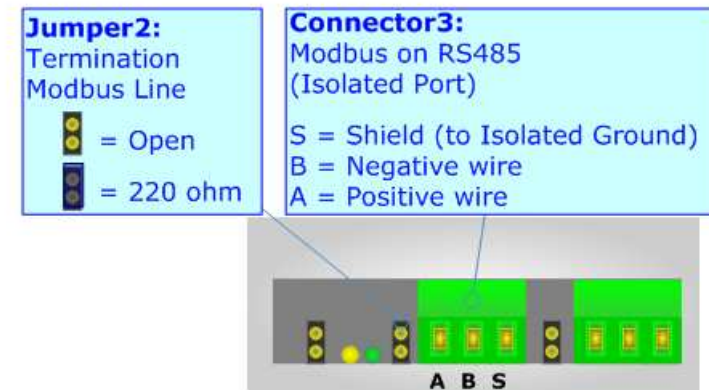
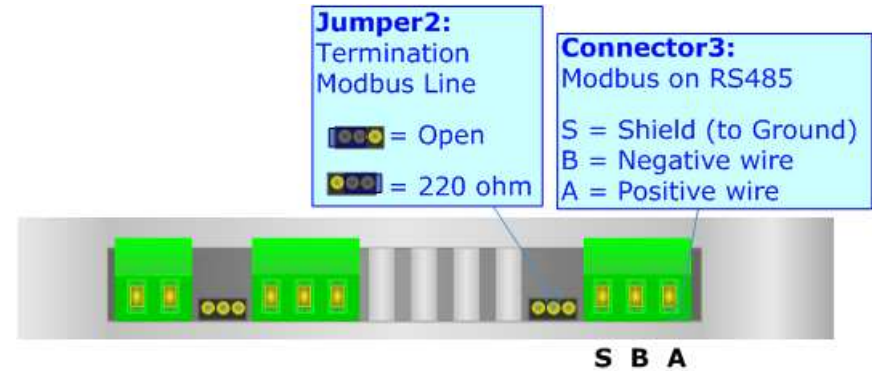

J1939:

The connection from CAN socket must be made with a cable with these characteristics:

DC parameter:	Impedance	70 Ohm/m
AC parameters:	Impedance	120 Ohm/m
	Delay	5 ns/m
Length	Baud Rate [bps]	Length MAX [m]
	10 k	5000
	20 k	2500
	50 k	1000
	100 k	650
	125 K	500
	250 K	250
	500 K	100
	800 k	50
	1000 k	25

For terminate the CAN line with a 120Ω resistor it is necessary to insert the 'Jumper1' of HD67050 or 'Jumper3' of HD67050M like in figure.

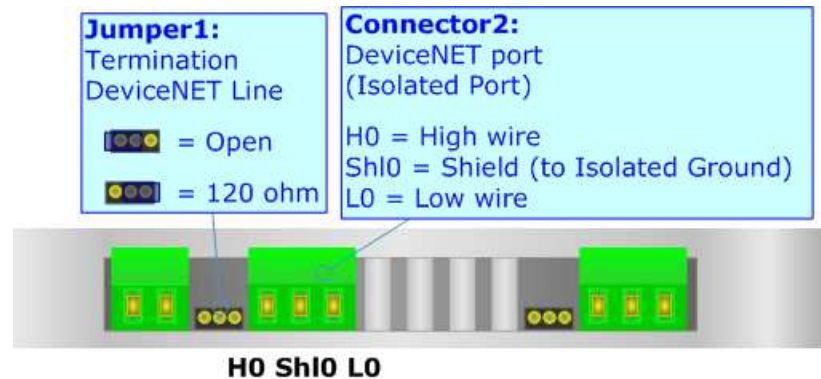

RS232:

The connection from RS232 socket to a serial port (example one from a personal computer), must be made with a Null Modem cable (a serial cable where the pins 2 and 3 are crossed). It is recommended that the RS232C Cable not exceed 15 meters.

The serial port is used for programming the device or for Modbus communication.

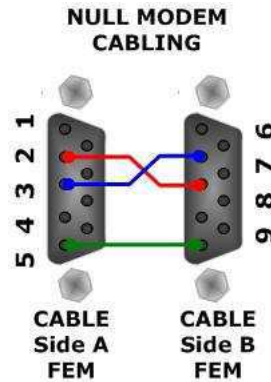

USE OF COMPOSITOR SW67050:

To configure the Gateway, use the available software that runs with Windows, called SW67050. It is downloadable on the site www.adfweb.com and its operation is described in this document.

When launching the SW67050 the right window appears (Fig. 3).

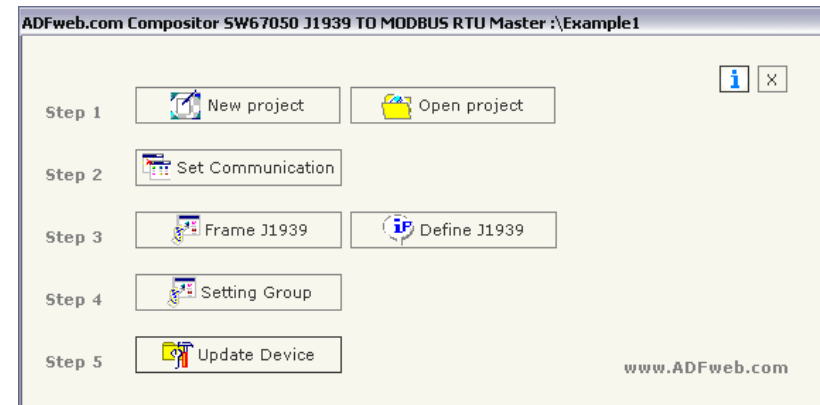

Figure 3: Main window for SW67050

NEW PROJECT / OPEN PROJECT:

The “**New Project**” button creates the folder which contains the entire device configuration.

A device configuration can also be imported and exported:

- To clone the configurations of a programmable J1939 from/to Modbus Gateway in order to configure another device in the same manner, it is necessary to maintain the folder and all its contents;
- To clone a project in order to obtain a different version of the project, it is sufficient to duplicate the project folder with another name and open the new folder with the button “**Open Project**”;
- When a new project is created or an existent project is open, it will be possible to access the various configuration section of the software:
 - **Set Communication;**
 - **Define the J1939 frames;**
 - **Define which Modbus registers read.**

SET COMMUNICATION:

This section defines the fundamental communication parameters of two Buses, J1939 and Modbus.

By pressing the **"Set communication"** button from the main window for SW67050 (Fig. 3) the window "Set Communication" appears (Fig. 4):

This window is divided in two sections, one for the J1939 and the other for the Modbus.

The means of the fields for "J1939" are:

- In the field **"Baud rate"** it is possible to select the Baud rate of the J1939 line;
- In the field **"Dev ID"** it is possible to assign an ID at the J1939 side.

The means of the fields for "Modbus" are:

- If the field **"RS232"** is checked, the serial line in use is the RS232, otherwise if the field **"RS485"** is checked, the serial line in use is the RS485;
- In the field **"Baud Rate"** the baudrate for the serial line is defined;
- In the field **"Parity"** the parity of the serial line is defined;
- In the field **"Stop Bit"** the number of Stop Bit is defined;
- In the field **"TimeOut"** there is the maximum time that the device attends for the answer from the Slave interrogated;
- In the field **"Cyclic Delay"** the delay between two requests is defined.

The screenshot shows a dialog box titled "SET COMMUNICATION". It is split into two main sections. The top section, labeled "J1939", contains two input fields: "Baud rate" with a dropdown menu showing "1000" and "Dev ID" with a text box containing "10". The bottom section, labeled "ModBus RTU", features two radio buttons: "RS232" (unselected) and "RS485" (selected). Below these are five more input fields: "Baud rate" (dropdown, "115200"), "Parity" (dropdown, "NONE"), "Stop Bit" (dropdown, "1 Stop Bit"), "Timeout (ms)" (text box, "1000"), and "Cyclic Delay (ms)" (text box, "100"). At the bottom of the dialog are two buttons: "OK" with a green checkmark icon and "Cancel" with a red X icon.

Figure 4: "Set Communication" window

FRAME J1939:

By pressing the "Frame J1939" button from the main window for SW67050 (Fig. 3) the window "J1939 frame" appears (Fig. 5):

The means for the fields are:

- ✦ In the field "**Priority**" insert the priority of the frame, in the J1939 protocol is a number among 0,1,2,3,4,5,6,7. The number 0 is the highest and the 7 is the lowest;
- ✦ In the field "**Data Page**" insert the data page, in the J1939 protocol is 0 or 1;
- ✦ In the field "**PGN**" insert the PGN of the data you would like to read from modbus to J1939 (in the J1939 protocol the PGN is an identifier);
- ✦ In the field "**Group**" it is possible to select when the frame is sent at J1939 side. The groups are defined under the section "Setting Group". If no group is selected the default is "On request" so another J1939 device has to make the request to the gateway and then it sends the frame;
- ✦ If the field "**Erase**" is checked, if the Master Modbus doesn't receive the reply to his request before the "Timeout (ms)" defined in "Set Communication" puts the value of the J1939 frame at 0;
- ✦ In the field "**Mnemonic**" it is possible to insert a description.

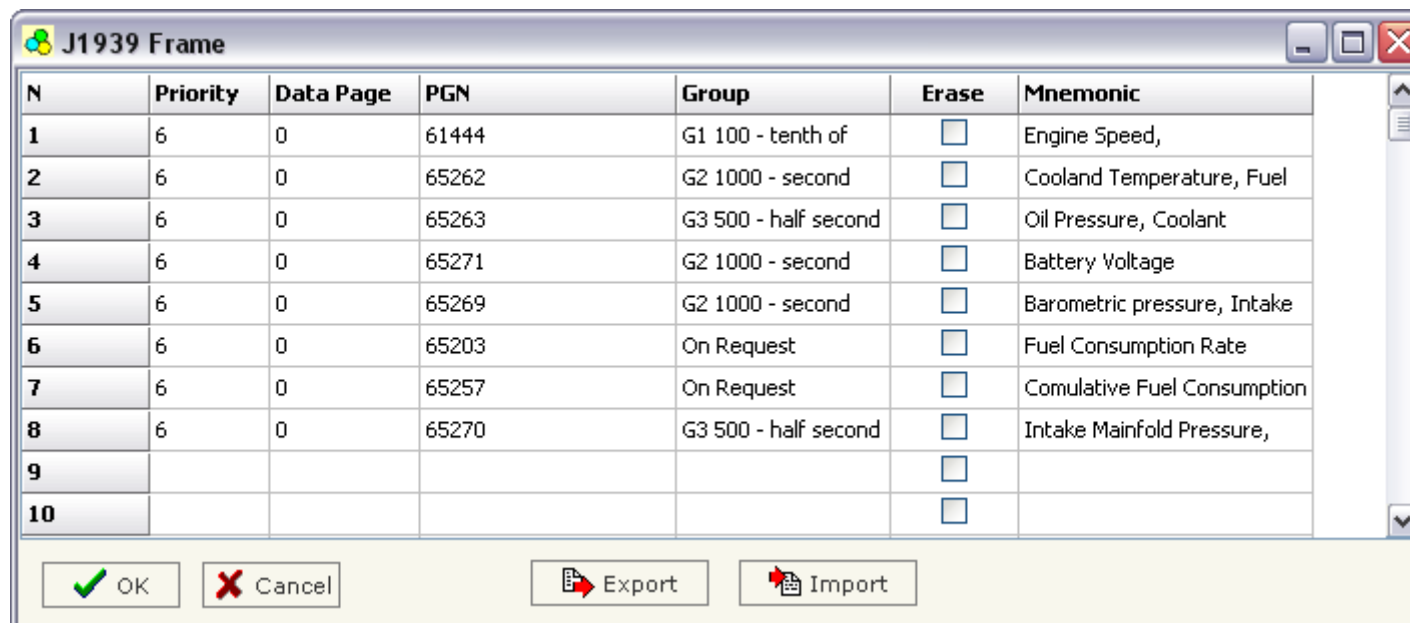

Figure 5: "J1939 Frame" window

DEFINE J1939:

By pressing the "Define J1939" button from the main window for SW67050 (Fig. 3) the window "Define Frames J1939" appears (Fig. 6):

- In the field "Correlated" there are PGN who you insert in the list (Frame J1939);
- In the field "MODBUS" there are the modbus words taht you have created for each PGN.

For create a Modbus register you have to select the desired "PGN", then:

- In the field "**Device ID**" insert the ID of the slave Modbus device that contain the register;
- In the field "**Index MODBUS**" you have to insert the Address of the register;
- In the filed "**Number of Points**" you have to select the number of consecutive registers to be read;
- In the field "**Type of Data**" you have to select which type of data to read.

After that selecting the various R1, R2, R3, R4, R5, R6, R7, R8 it is possible to define in the "**Selected Frame Bytes**" how the modbus value is put into the J1939 frame. If you have selected "Number of Point"=1 you can use only the R1; if you have selected 3 you can use only the R1, R2 and R3. And so on. Then press the "New" button for add the created register.

You can add a new modbus word by pressing the "**New**" button; modify an existing one by pressing "**Modify**"; delete by pressing "**Delete**", copy and paste.

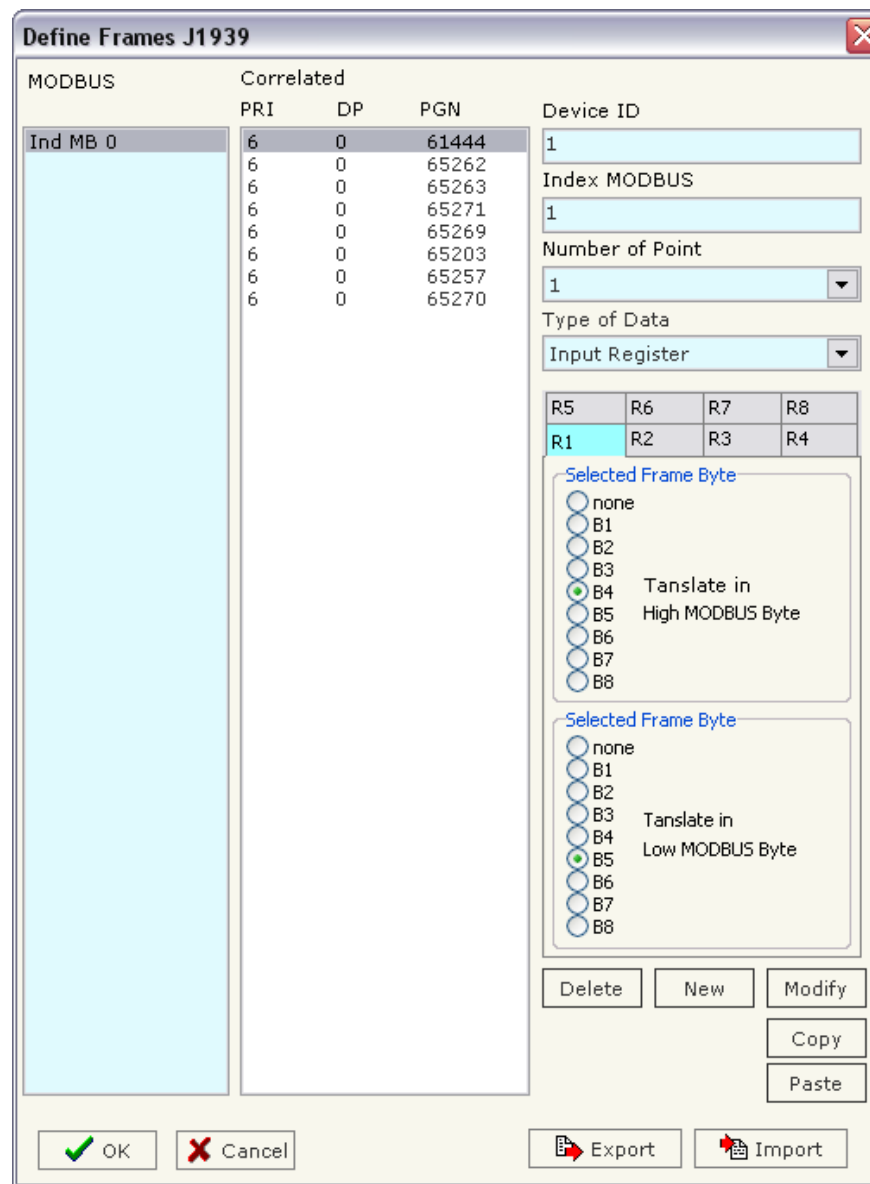

Figure 6: "Define Frames J1939" window

SETTING GROUP:

By pressing the **Setting Group** button from the main window of SW67050 the window "Groups Setting" appears (Fig. 7).

It is possible to define a maximum of ten groups.

These groups are used in the "J1939 Frame" for define when the gateway sends the frames.

Each group is composed of a "Cyclic Time [ms]" and a "Mnemonic".

The means for the fields are:

- ➔ In the field **Cyclic Time [ms]** insert a time expressed in milliseconds. This time is used for send cyclically the J1939 frames with this group defined in the "J1939 Frame" when the time is expired;
- ➔ In the field **Mnemonic** it is possible to insert a description.

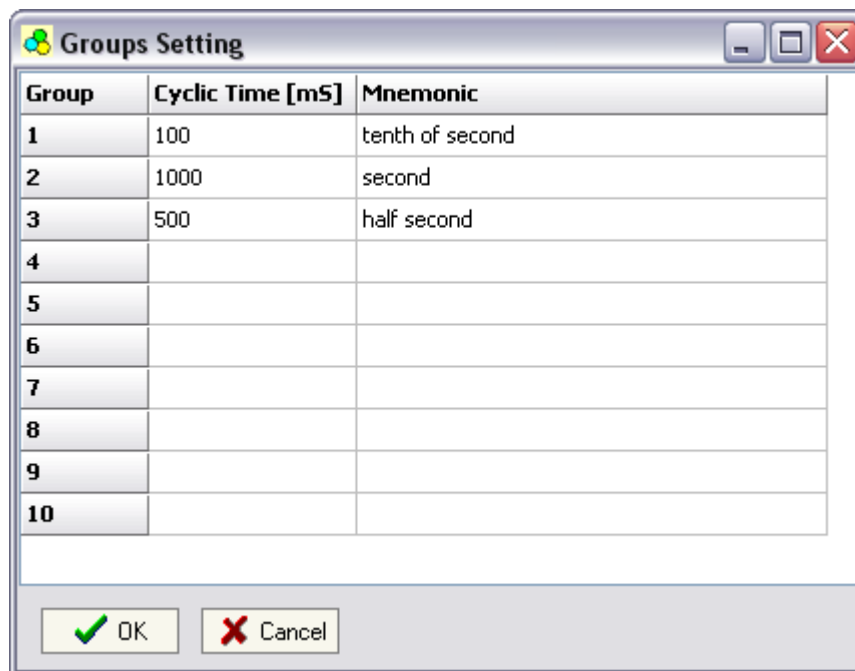

Group	Cyclic Time [mS]	Mnemonic
1	100	tenth of second
2	1000	second
3	500	half second
4		
5		
6		
7		
8		
9		
10		

Figure 7: "Groups Setting" window

UPDATE DEVICE:

By pressing the **Update Device** button it is possible to load the created Configuration into the device; and also the Firmware, if is necessary.

In order to load the parameters or update the firmware in the device, follow these instructions:

- Turn off the Device;
- Connect the RS232 Null Modem Cable form your PC to the Gateway;
- Insert the Boot Jumper (For more info see Fig. 1 or Fig. 2);
- Select the **COM port** and press the **Connect** button;
- Turn on the device;
- Check the BOOT Led. It must blink quickly (see "LEDS" section);
- Press the **Next** button;
- Select which operations you want to do.
- Press the **Execute update firmware** button to start the upload;
- When all the operations are "OK" turn off the device;
- Disconnect the Boot jumper;
- Disconnect the RS232 Cable;
- Turn on the device.

At this point the configuration/firmware on the device is correctly update.

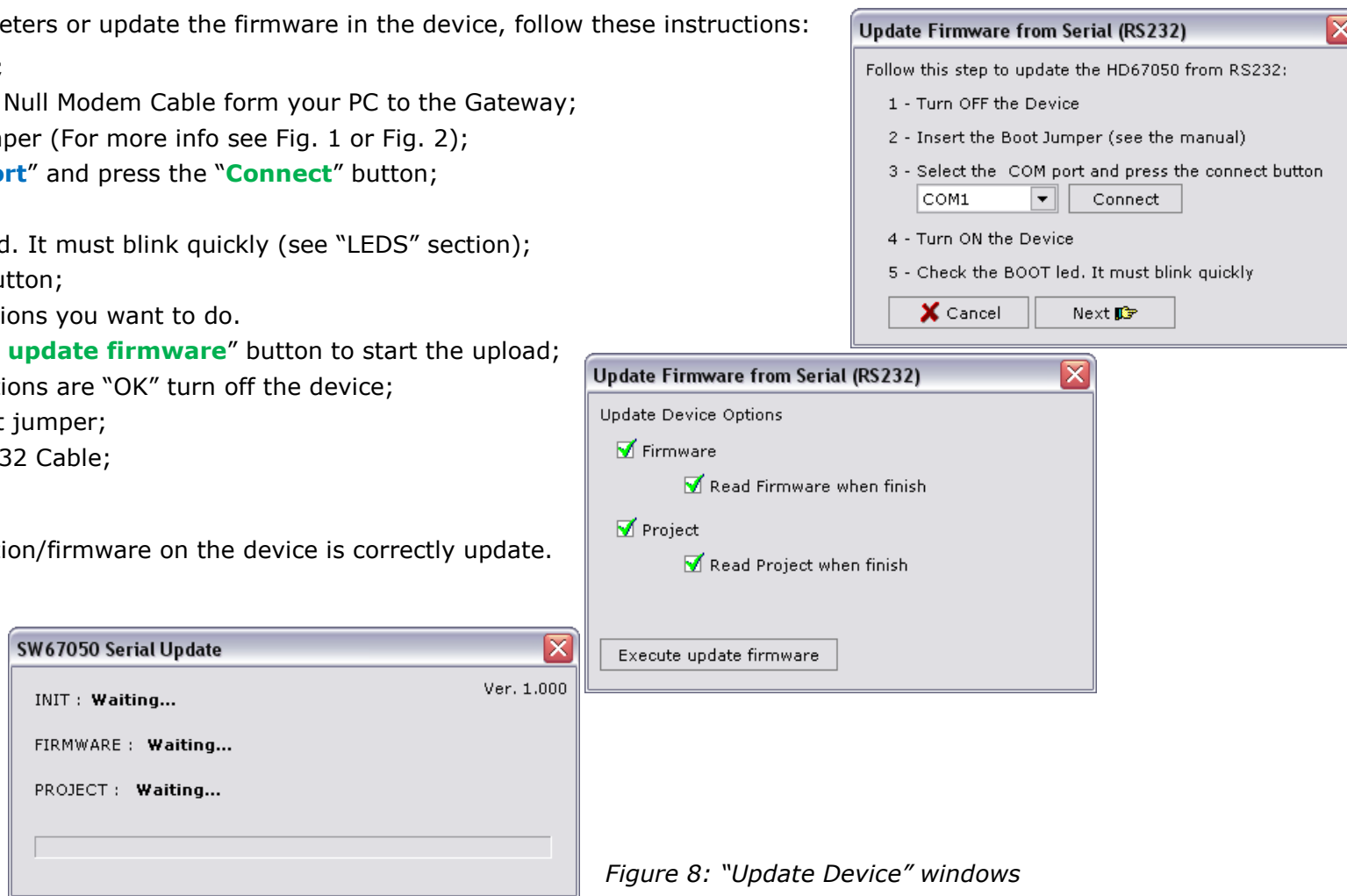

Figure 8: "Update Device" windows

**Note:**

When you install a new version of the software it is better if the first time you do the update of the Firmware in the HD67050 or HD67050M device.

**Warning:**

If the Fig. 8 appears when you try to do the Update before require assistance try these points:

- Check if the serial COM port selected is the correct one;
- Check if the serial is connected between the PC and the device;
- Try to repeat the operations for the updating;
- If you are using a dongle try with a native COM port or change the dongle;
- Try with another PC;
- Try to restart the PC;
- If you are using the program inside a Virtual Machine, try to use in the main Operating System.



Figure 9: "Protection" window



In the case of HD67050 or HD67050M you have to use the software "SW67050": www.adfweb.com/download/filefold/SW67050.zip.

MECHANICAL DIMENSIONS:

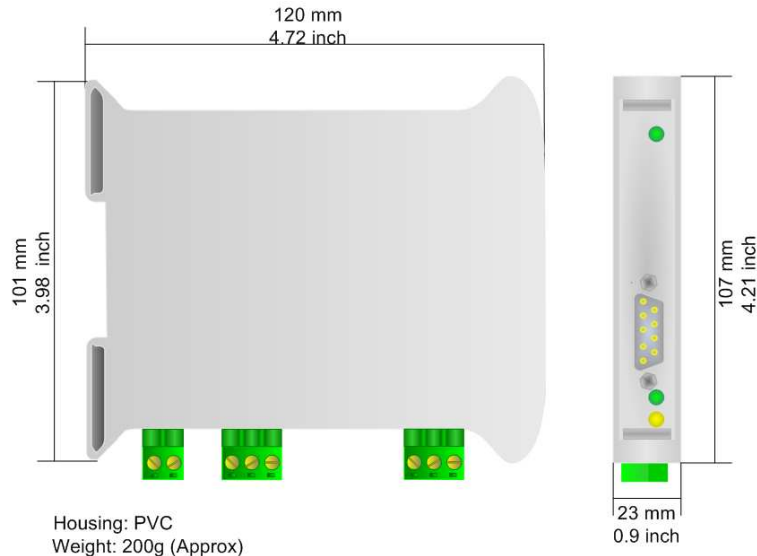

Figure 11: Mechanical dimensions scheme for HD67050

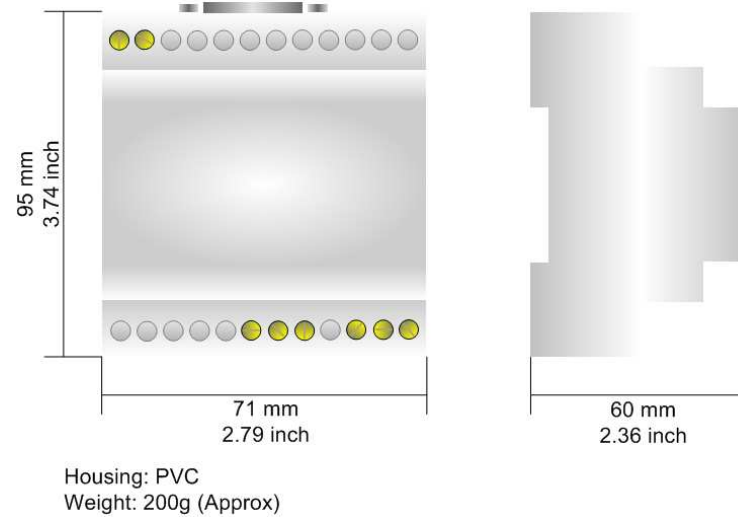

Figure 12: Mechanical dimensions scheme for HD67050M

ORDER CODES:

- Order Code: **HD67050** - J1939 / Modbus Master - Converter
- Order Code: **HD67050M** - J1939 / Modbus Master - Converter (Different enclosure)

ACCESSORIES:

- Order Code: **AC34107** - Null Modem Cable Fem/Fem DSub 9 Pin 1,5 m
- Order Code: **AC34114** - Null Modem Cable Fem/Fem DSub 9 Pin 5 m
- Order Code: **AC34001** - Rail DIN - Power Supply 220/240V AC 50/60Hz – 12 V AC
- Order Code: **AC34002** - Rail DIN - Power Supply 110V AC 50/60Hz – 12 V AC

DISCLAIMER

All technical content within this document can be modified without notice. The content of the document content is a recurring audit. For losses due to fire, earthquake, third party access or other accidents, or intentional or accidental abuse, misuse, or use under abnormal conditions repairs are charged to the user. ADFweb.com S.r.l. will not be liable for accidental loss of use or inability to use this product, such as loss of business income. ADFweb.com S.r.l. shall not be liable for consequences of improper use.

OTHER REGULATIONS AND STANDARDS

WEEE INFORMATION



Disposal of old electrical and electronic equipment (as in the European Union and other European countries with separate collection systems).

— This symbol on the product or on its packaging indicates that this product may not be treated as household rubbish. Instead, it should be taken to an applicable collection point for the recycling of electrical and electronic equipment. If the product is disposed correctly, you will help prevent potential negative environmental factors and human health, which could otherwise be caused by inappropriate disposal. The recycling of materials will help to conserve natural resources. For more information about recycling this product, please contact your local city office, your household waste disposal service or the shop where you purchased the product.

RESTRICTION OF HAZARDOUS SUBSTANCES DIRECTIVE



The device respects the 2002/95/EC Directive on the restriction of the use of certain hazardous substances in electrical and electronic equipment (commonly referred to as Restriction of Hazardous Substances Directive or RoHS).

CE MARKING



The product conforms with the essential requirements of the applicable EC directives.

WARRANTIES AND TECHNICAL SUPPORT:

For fast and easy technical support for your ADFweb.com SRL products, consult our internet support at www.adfweb.com.

Otherwise contact us at the address support@adfweb.com

RETURN POLICY:

If while using your product you have any problem and you wish to exchange or repair it, please do the following:

- 1) Obtain a Product Return Number (PRN) from our internet support at www.adfweb.com. Together with the request, you need to provide detailed information about the problem.
- 2) Send the product to the address provided with the PRN, having prepaid the shipping costs (shipment costs billed to us will not be accepted).

If the product is within the warranty of twelve months, it will be repaired or exchanged and returned within three weeks.

If the product is no longer under warranty, you will receive a repair estimate.

PRODUCTS AND RELATED DOCUMENTS:

Part	Description	URL
HD67216	CAN bus Analyzer	www.adfweb.com?product=HD67216
HD67121	Gateway CANopen / Canopen	www.adfweb.com?product=HD67121
HD67004 HD67005	Gateway CANopen / Modbus – Ethernet TCP	www.adfweb.com?product=HD67004
HD67134	Gateway CANopen / DeviceNet	www.adfweb.com?product=HD67134
HD67117	CAN bus Repeater	www.adfweb.com?product=HD67117
HD67502	Gateway CANopen / Modbus - RTU	www.adfweb.com?product=HD67502