

User Manual

Revision 1.002
English

PROFINET / CAN - Converter

(Order Code: HD67606-A1)

Benefits and Main Features:

Very



Electrical isolation



Temperature range: -40°C/85°C (-40°F/185°F)



INDEX:

	Page
INDEX	2
UPDATED DOCUMENTATION	2
REVISION LIST	2
WARNING	2
TRADEMARKS	2
SECURITY ALERT	3
EXAMPLE OF CONNECTION	4
CONNECTION SCHEME	5
CHARACTERISTICS	6
CONFIGURATION	6
POWER SUPPLY	7
FUNCTION MODES	8
LEDS	9
PROFINET	10
CAN	11
USE OF COMPOSITOR SW67606	12
NEW PROJECT / OPEN PROJECT	13
SOFTWARE OPTIONS	14
SET COMMUNICATION	15
RECEIVE FRAMES	16
INFO RECEIVE	17
SEND FRAMES	18
INFO SEND	19
XML FILE	20
UPDATE DEVICE	21
SENDING ASYNCHRONOUS CAN MESSAGES FROM ETHERNET	23
MECHANICAL DIMENSIONS	25
ORDERING INFORMATIONS	26
ACCESSORIES	26
PLC CONFIGURATION	27
DISCLAIMER	32
OTHER REGULATIONS AND STANDARDS	32
WARRANTIES AND TECHNICAL SUPPORT	33
RETURN POLICY	33

UPDATED DOCUMENTATION:

Dear customer, we thank you for your attention and we remind you that you need to check that the following document is:

- ✚ Updated
- ✚ Related to the product you own

To obtain the most recently updated document, note the “document code” that appears at the top right-hand corner of each page of this document.

With this “Document Code” go to web page www.adfweb.com/download/ and search for the corresponding code on the page. Click on the proper “Document Code” and download the updates.

REVISION LIST:

Revision	Date	Author	Chapter	Description
1.000	20/09/2012	Dp	All	First Release
1.001	24/07/2013	Fl	All	Revision
1.002	27/01/2015	Ff	All	New Software Interface
1.003	17/06/2022	Ff	All	Hardware revision

WARNING:

ADFweb.com reserves the right to change information in this manual about our product without warning. ADFweb.com is not responsible for any error this manual may contain.

TRADEMARKS:

All trademarks mentioned in this document belong to their respective owners.

SECURITY ALERT:**GENERAL INFORMATION**

To ensure safe operation, the device must be operated according to the instructions in the manual. When using the device, legal and safety regulation are required for each individual application. The same applies also when using accessories.

INTENDED USE

Machines and systems must be designed so the faulty conditions do not lead to a dangerous situation for the operator (i.e. independent limit switches, mechanical interlocks, etc.).

QUALIFIED PERSONNEL

The device can be used only by qualified personnel, strictly in accordance with the specifications. Qualified personnel are persons who are familiar with the installation, assembly, commissioning and operation of this equipment and who have appropriate qualifications for their job.

RESIDUAL RISKS

The device is state-of-the-art and is safe. The instruments can represent a potential hazard if they are inappropriately installed and operated by untrained personnel. These instructions refer to residual risks with the following symbol:



This symbol indicates that non-observance of the safety instructions is a danger for people that could lead to serious injury or death and / or the possibility of damage.

CE CONFORMITY

The declaration is made by our company. You can send an email to or give us a call if you need it.

EXAMPLE OF CONNECTION:

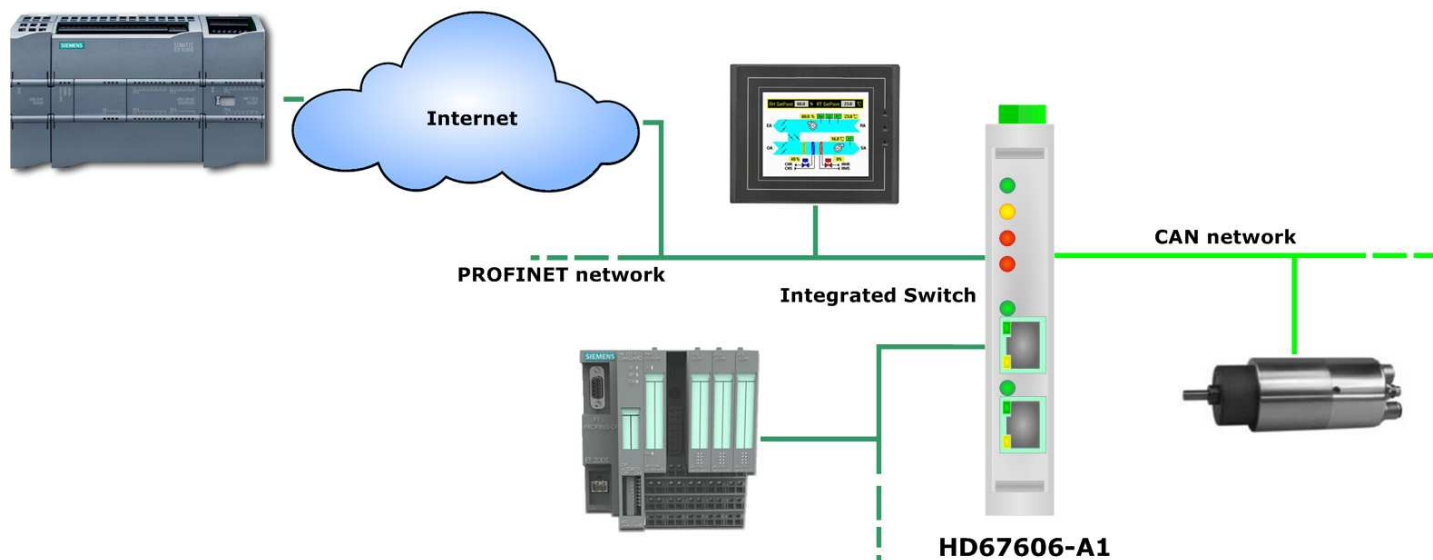
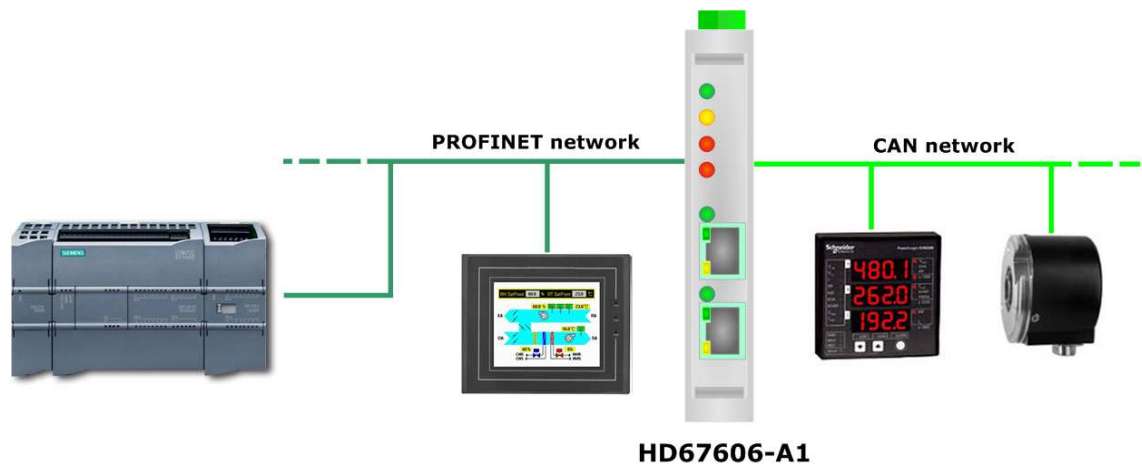

CONNECTION SCHEME:

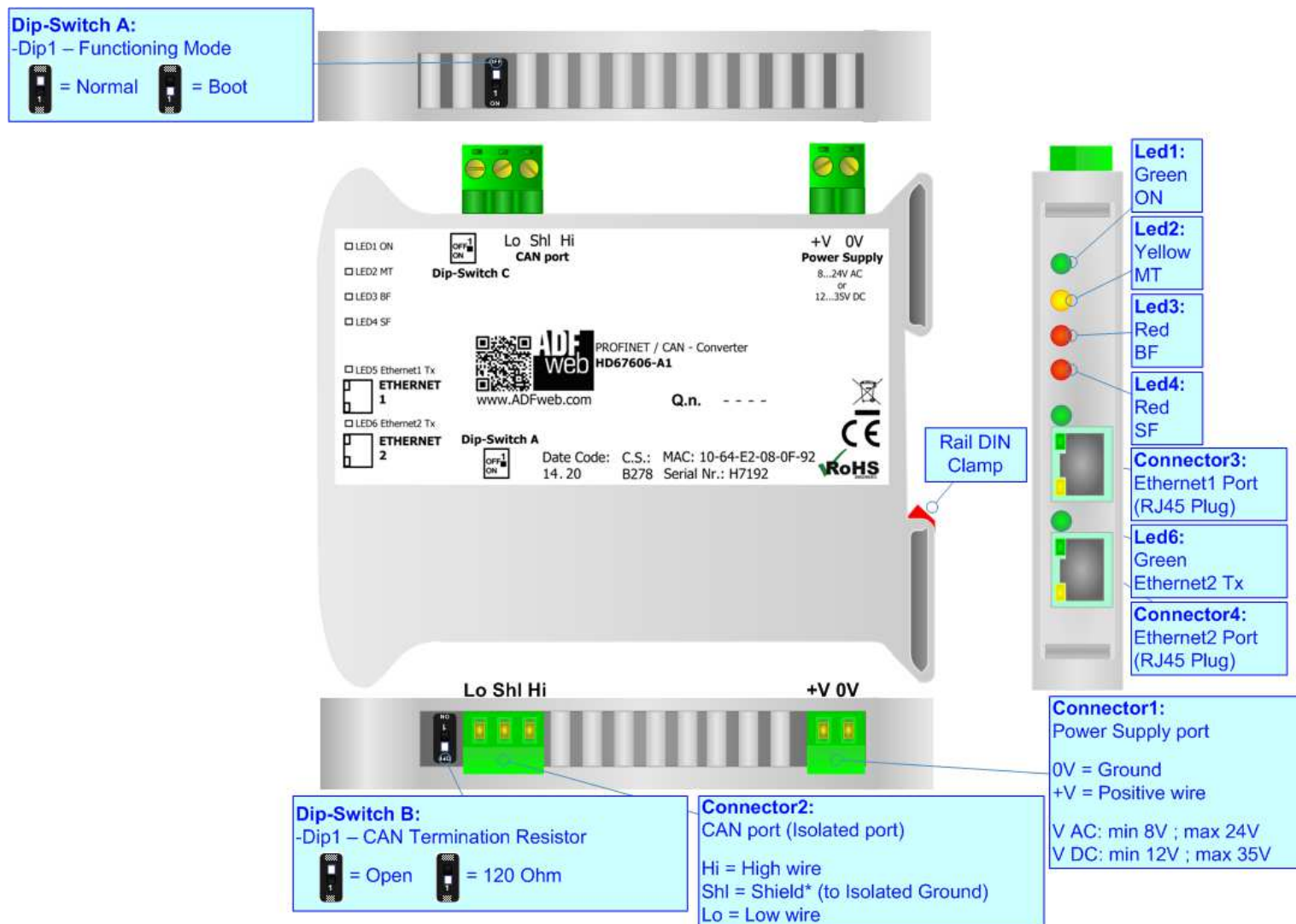

Figure 1: Connection scheme for HD67606-A1

CHARACTERISTICS:

The HD67606-A1 is a PROFINET / CAN Converter.

It has the following characteristics:

- Up to 1440 bytes in reading and 1440 bytes in writing;
- Triple isolation between CAN - Power Supply, CAN - Ethernet, Power Supply - Ethernet.
- Two-directional information between CAN bus and PROFINET bus;
- Mountable on 35mm Rail DIN;
- Wide power supply input range: 8...24V AC or 12...35V DC;
- Wide temperature range: -40°C / 85°C [-40°F / +185°F].



CONFIGURATION:

You need Compositor SW67606 software on your PC in order to perform the following:

- Define the parameter of PROFINET line;
- Define the parameter of CAN line;
- Define the CAN frames that the Converter can accept;
- Define the CAN frames that the Converter sends through the CAN line;
- Define the map of CAN byte that must be written in the PROFINET array;
- Define the map of which PROFINET bytes must be written in CAN frames;
- Update the device.

POWER SUPPLY:

The devices can be powered at 8...24V AC and 12...35V DC. For more details see the two tables below.

VAC 		VDC 	
Vmin	Vmax	Vmin	Vmax
8V	24V	12V	35V

Consumption at 24V DC:

Device	Consumption [W/VA]
HD67606-A1	3.5

Caution: Not reverse the polarity power

Connector1:
 Power Supply port
 0V = Ground
 +V = Positive wire
 V AC: min 8V ; max 24V
 V DC: min 12V ; max 35V

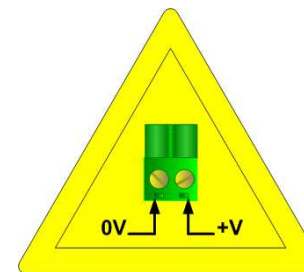

HD67606-A1

FUNCTION MODES:

The device has got two functions mode depending of the position of the 'Dip1 of Dip-Switch A':

- The first, with 'Dip1 of Dip-Switch A' at "OFF" position, is used for the normal working of the device.
- The second, with 'Dip1 of Dip-Switch A' at "ON" position, is used for upload the Project and/or Firmware.

For the operations to follow for the updating, see 'UPDATE DEVICE' section.

According to the functioning mode, the LEDs will have specifics functions, see 'LEDS' section.

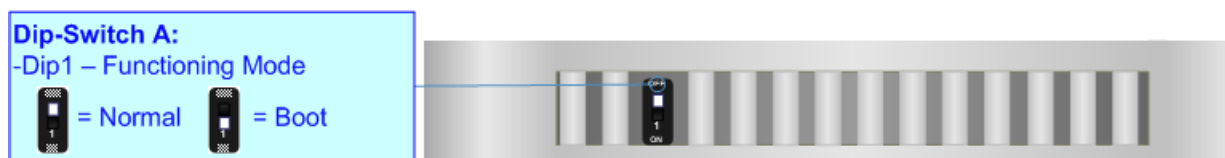

LEDS:

The device has got six LEDs that are used to give information of the functioning status. The various meanings of the LEDs are described in the table below.

LED	Normal Mode	Boot Mode
1: ON [supply voltage] (green)	ON: Device powered OFF: Device not powered	ON: Device powered OFF: Device not powered
2: MT [maintenance display] (yellow)	ON: Maintenance Problem is present OFF: No maintenance are present	Blinks quickly: Boot state Blinks very slowly (~0.5Hz): update in progress
3: BF [bus fault] (red)	ON: The Ethernet connection is defective; the IP address exists several times in the network; the own NameOfStation exists several times in the network; no IP address has been set Flashing: At least one configured AR is no longer in the data exchange OFF: No errors are present	Blinks quickly: Boot state Blinks very slowly (~0.5Hz): update in progress
4: SF [group error] (red)	ON: At least one AR is not in the data exchange OFF: No errors are present	Blinks quickly: Boot state Blinks very slowly (~0.5Hz): update in progress
5: Ethernet1 Tx (green)	Blinks when is transmitting Ethernet frames	Blinks quickly: Boot state Blinks very slowly (~0.5Hz): update in progress
6: Ethernet2 Tx (green)	Blinks when is transmitting Ethernet frames	Blinks quickly: Boot state Blinks very slowly (~0.5Hz): update in progress

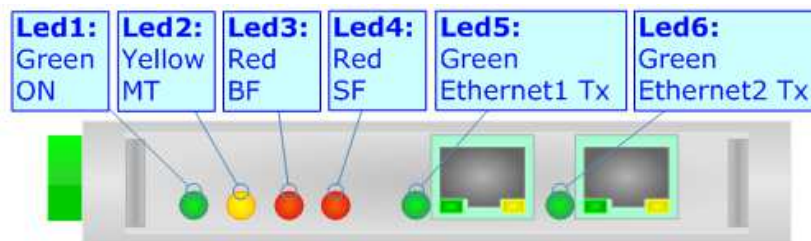

PROFINET:

The PROFINET connection must be made using Connector3 and/or Connector4 of HD67606-A1 with at least a Category 5E cable. The maximum length of the cable should not exceed 100m. The cable has to conform to the T568 norms relative to connections in cat.5 up to 100 Mbps. To connect the device to an Hub/Switch is recommended the use of a straight cable, to connect the device to a PC/PLC/other is recommended the use of a cross cable.

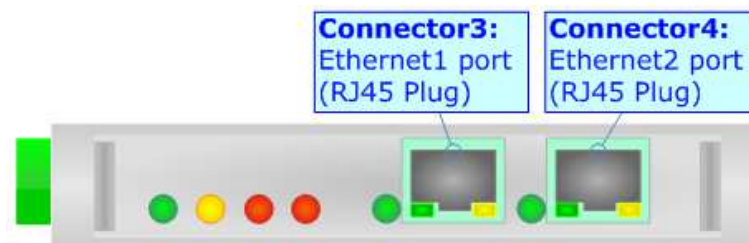

CAN:

For terminate the CAN line with a 120Ω resistor it is necessary that the Dip1 of 'Dip-Switch C' is at ON position.

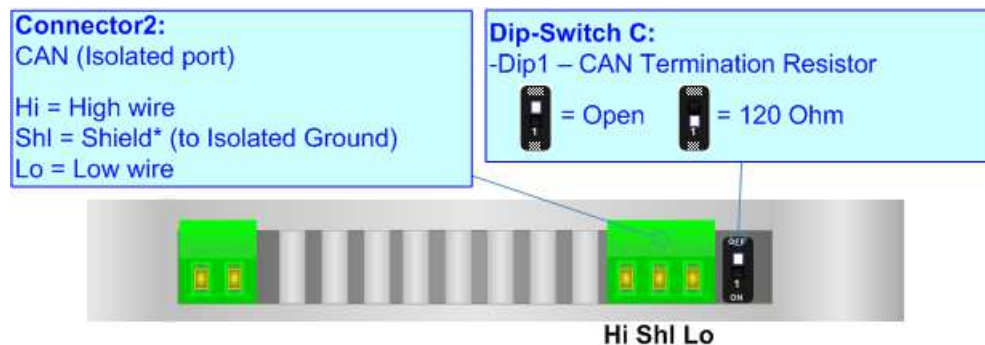

Cable characteristics:

DC parameter:	Impedance	70 Ohm/m
AC parameters:	Impedance	120 Ohm/m
	Delay	5 ns/m
Length	Baud Rate [bps]	Length MAX [m]
	10 K	5000
	20 K	2500
	50 K	1000
	100 K	650
	125 K	500
	250 K	250
	500 K	100
	800 K	50
	1000 K	25

USE OF COMPOSITOR SW67606:

To configure the Converter, use the available software that runs with Windows called SW67606. It is downloadable on the site www.adfweb.com and its operation is described in this document. *(This manual is referenced to the last version of the software present on our web site).* The software works with MSWindows (XP, Vista, Seven, 8; 32/64bit).

When launching the SW67606, the window below appears (Fig. 2).



Note:

It is necessary to have installed .Net Framework 4.

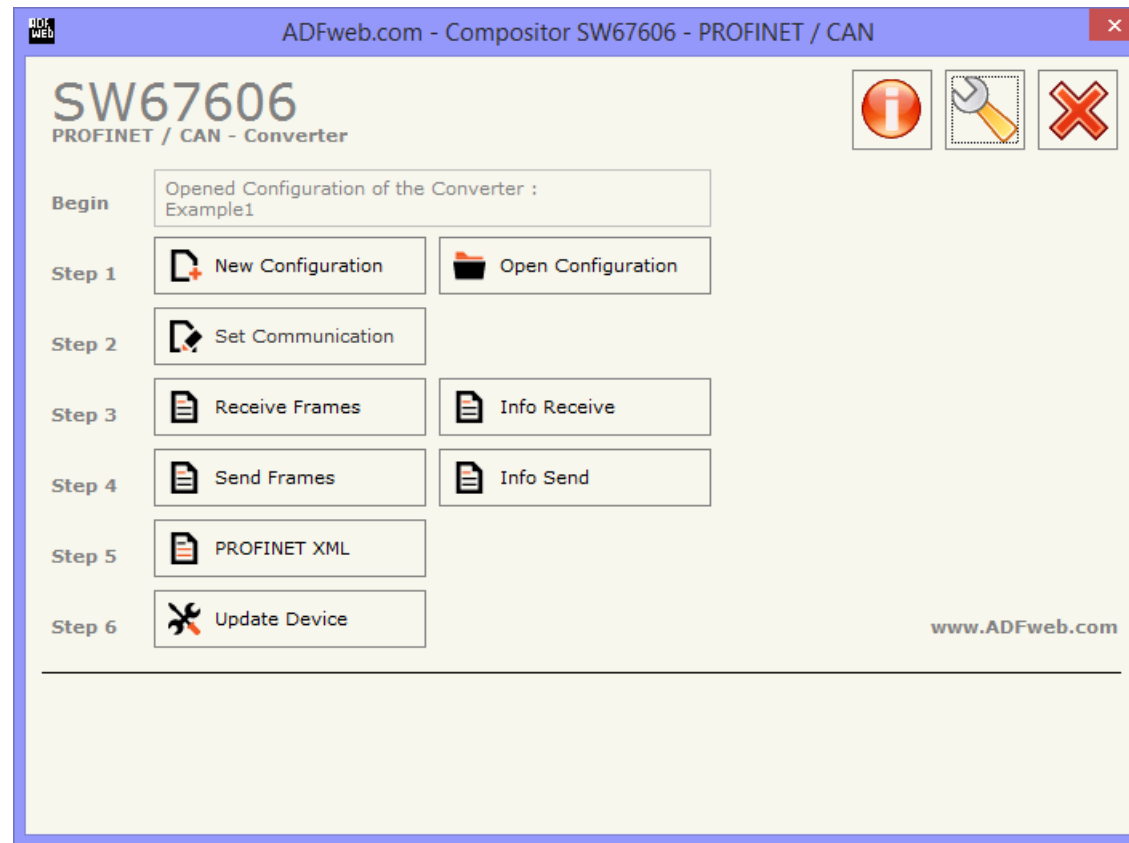
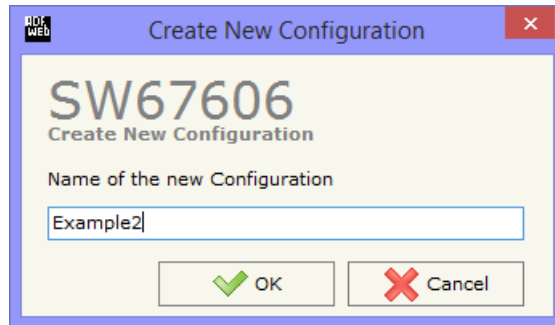

Figure 2: Main window for SW67606

NEW CONFIGURATION / OPEN CONFIGURATION:

The “**New Configuration**” button creates the folder which contains the entire device’s configuration.



A device’s configuration can also be imported or exported:

- To clone the configurations of a Programmable “PROFINET Slave / CAN - Converter” in order to configure another device in the same manner, it is necessary to maintain the folder and all its contents;
- To clone a project in order to obtain a different version of the project, it is sufficient to duplicate the project folder with another name and open the new folder with the button “**Open Configuration**”.

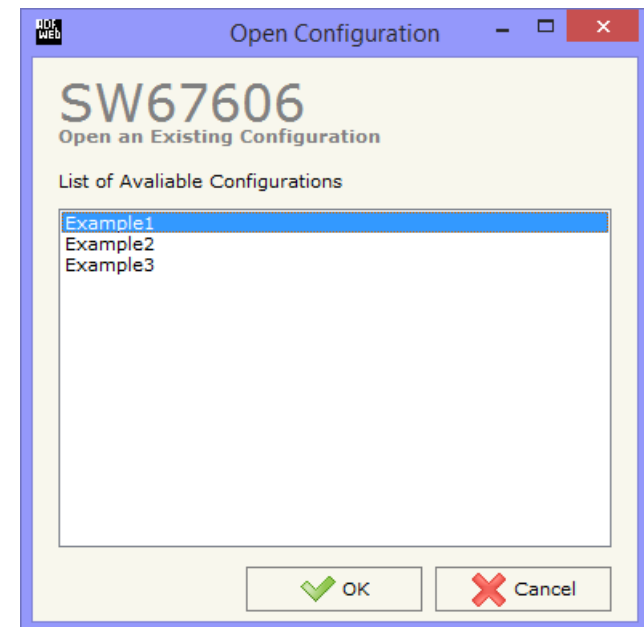

SOFTWARE OPTIONS:

By pressing the “**Settings**” () button there is the possibility to change the language of the software and check the updatings for the compositor.

In the section “Language” it is possible to change the language of the software.

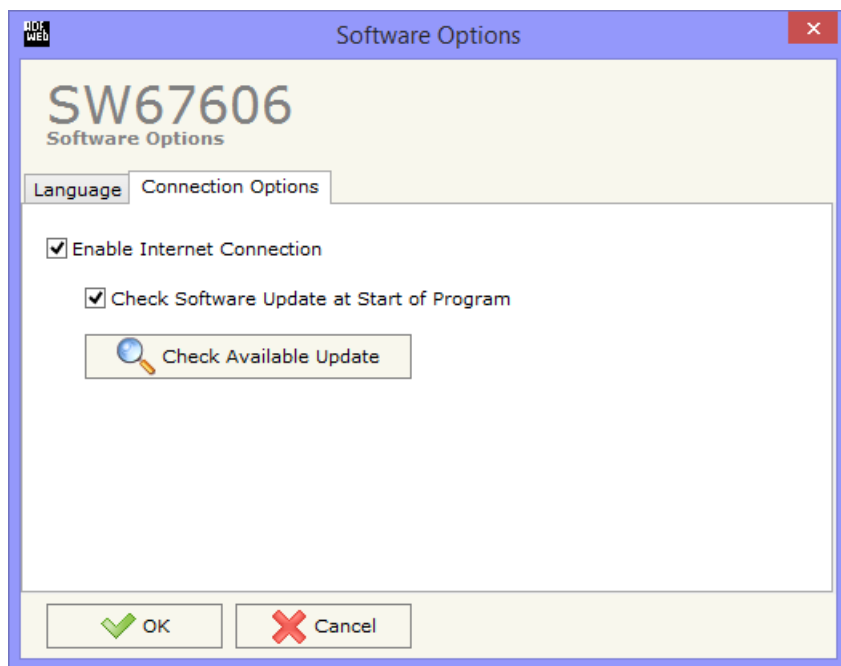

In the section “Connection Options”, it is possible to check if there are some updatings of the software compositor in ADFweb.com website. Checking the option “**Check Software Update at Start of Program**”, the SW67606 check automatically if there are updatings when it is launched.

SET COMMUNICATION:

This section define the fundamental communication parameters of two buses, PROFINET and CAN.

By Pressing the **"Set Communication"** button from the main window for SW67606 (Fig. 2) the window "Set Communication" appears (Fig. 3).

The window is divided in two sections, one for the PROFINET and the other for the CAN.

The means of the fields for "PROFINET" are:

- In the fields **"IP ADDRESS"** insert the IP address that you want to give to the Converter;
- In the fields **"SUBNET Mask"** insert the SubNet Mask;
- In the fields **"GATEWAY"** insert the default gateway that you want to use. This feature can be enabled or disabled pressing the Check Box field. This feature is used for going out of the net;
- In the field **"Tunneling Port"** it is possible to define the port to use for the "Tunneling mode" (see page 23 for more details);
- In the field **"Send Back CAN messages"** it is possible to enable the transmission of CAN messages in a transparent mode;
- If the option **"Reply on the Tunneling Port"** is checked, the CAN messages are sent to the Tunneling Port (applicable only if the "Send back CAN messages" is enabled);
- In the field **"PROFINET Name of Station"** is possible to assign a name to the PROFINET node;
- In the fields **"Number Byte IN"** insert the number of input byte of the slave station;
- In the fields **"Number Byte Out"** insert the number of output byte of the slave station.

The means of the fields for the "CAN" section are:

- In the **"Baudrate"** field the CAN baudrate is defined.

The screenshot shows a web-based configuration window titled "Set Communication" for device "SW67606". The window is divided into two main sections: "PROFINET" and "CAN".

PROFINET Section:

- IP ADDRESS:** 192 . 168 . 0 . 10
- SUBNET Mask:** 255 . 255 . 255 . 0
- GATEWAY:** 192 . 168 . 0 . 1
- Tunneling Port:** 1
- Send Back CAN Messages:**
- Reply on the Tunneling Port:**
- PROFINET Name of Station:** devicename1
- Number Byte IN:** 1439
- Number Byte Out:** 1439

CAN Section:

- Baudrate:** 1000K

At the bottom of the window, there are two buttons: "OK" (with a green checkmark) and "Cancel" (with a red X).

Figure 3: "Set Communication" window

RECEIVE FRAMES:

By pressing the "Receive Frames" button from the main window for SW67606 (Fig. 2) the "Receive CAN Frames" window appears (Fig. 4).

The COB inserted in this table contains the Output data of PROFINET. These frames are accepted by the Converter.

The data of the columns have the following meanings:

- In the field "Cob-ID" insert the COB of the CAN frame;
- In the field "Type" is possible to select which type of CAN packet use for this Cob-ID; or 2.0A (11 bits) or 2.0B (29 bits);
- In the field "Dimension" insert the number of byte of the COB (from 1 to 8);
- The field "TimeOut" is used for put at zero the data into PROFINET if the CAN frame don't arrives with a frequency less than the time expressed in the field. If the value in the field is 0, means that you don't want to use this feature, and so the value is never deleted;
- In the field "Mnemonic" it is possible to insert a brief description.

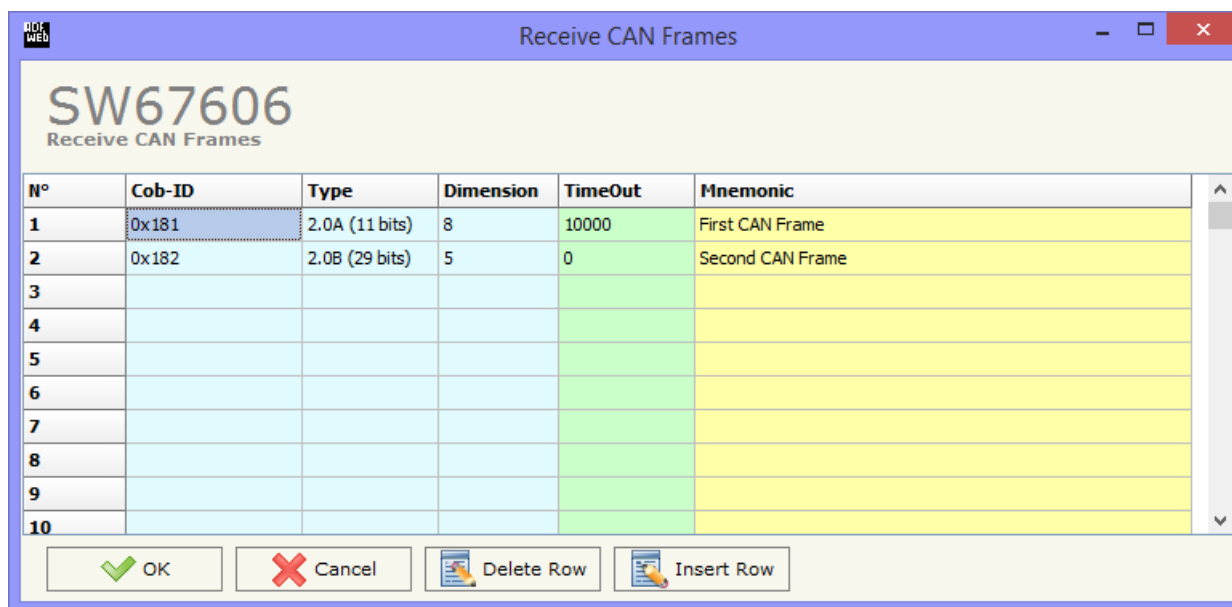

Figure 4: "Receive CAN Frames" window

INFO RECEIVE:

By pressing the "Info Receive" button from the main window for SW67606 (Fig. 2) the "Receive CAN Frames Info" window appears (Fig. 5).

- In the "COB ID" field there are the COB ID that you have inserts in the "Receive CAN Frames" window;
- In the "Bytes" field select the correspondence of the byte in PROFINET.

For Example:

Byte 1 of frame CAN go to byte 0 in PROFINET: the first byte of CAN frame is 0x11 in the byte 0 of PROFINET I can read 0x11.

COB ID	Bytes
0x181	Byte 1 of frame CAN go to byte <input type="text" value="0"/> of PROFINET
0x182	Byte 2 of frame CAN go to byte <input type="text" value="1"/> of PROFINET
	Byte 3 of frame CAN go to byte <input type="text" value="2"/> of PROFINET
	Byte 4 of frame CAN go to byte <input type="text" value="3"/> of PROFINET
	Byte 5 of frame CAN go to byte <input type="text" value="4"/> of PROFINET
	Byte 6 of frame CAN go to byte <input type="text" value="5"/> of PROFINET
	Byte 7 of frame CAN go to byte <input type="text" value="6"/> of PROFINET
	Byte 8 of frame CAN go to byte <input type="text" value="7"/> of PROFINET

Figure 5: "Receive CAN Frames Info" window

SEND FRAMES:

By pressing the "Send Frames" button from the main window for SW67606 (Fig. 2) the "Send CAN frames" window appears (Fig. 6).

The COB inserted in this table contains the Input data of PROFINET. These frames are sent by the Converter.

The data of the columns have the following meanings:

- In the field "Cob-ID" insert the COB of the CAN frame;
- In the field "Type" is possible to select which type of CAN packet use for this Cob-ID; or 2.0A (11 bits) or 2.0B (29 bits);
- In the field "Dimension" insert the number of byte of the COB (from 1 to 8);
- In the field "Send Frame Type" is possible to select when send the CAN frame. There are two options: the first is "On Data Change", the frame is sent when the data changes; the second is "On Times" and the frame is send cyclically;
- In the field "Timer Send" insert the interval used for the "Send Frame Type On Times". The time is in milliseconds;
- In the field "Mnemonic" it is possible to insert a brief description.

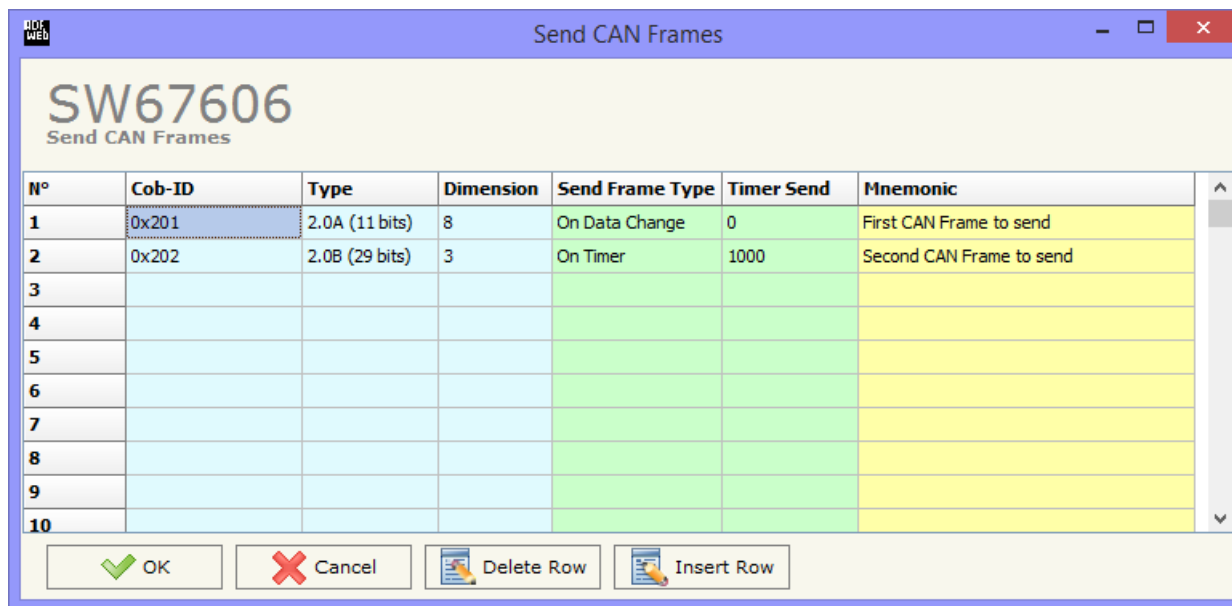

Figure 6: "Send CAN Frames" window

INFO SEND:

By pressing the “Info Send” button from the main window for SW67606 (Fig. 2) the “Send CAN Frames Info” window appears (Fig. 7).

- In the “COB ID” field there are the COB ID that you have inserts in the “Send CAN frames” window;
- In the field “Bytes” select the correspondence of the byte in PROFINET.

For Example:

Byte 1 of frame CAN is byte 0 in PROFINET: the byte 0 of PROFINET is 0x22, the first byte of CAN frame with COB=0x201 will be 0x22.

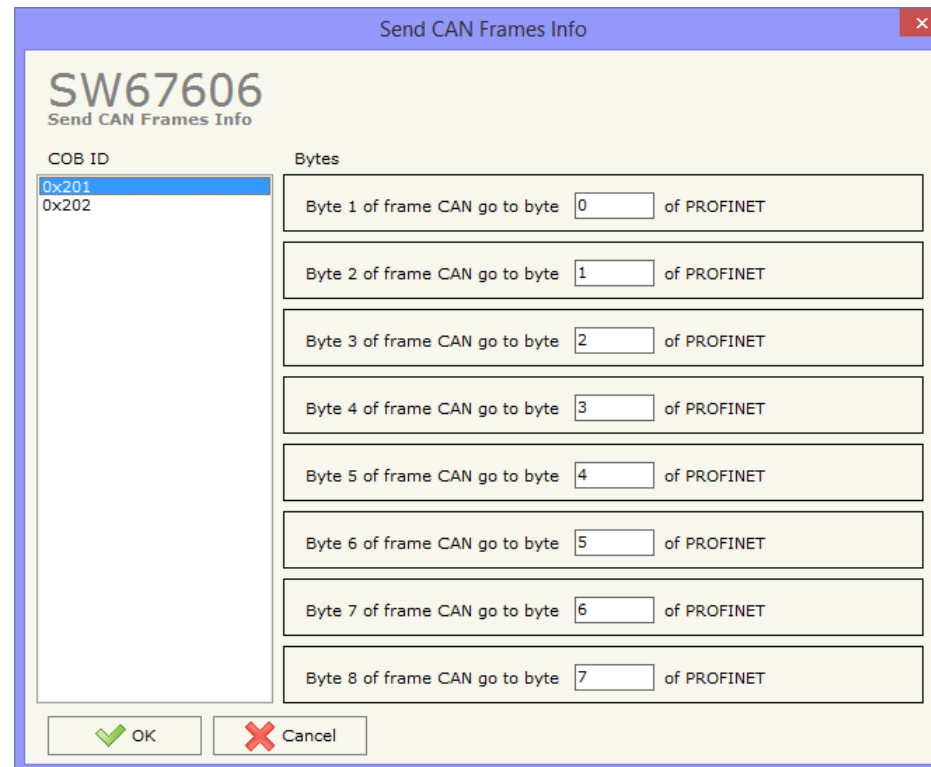
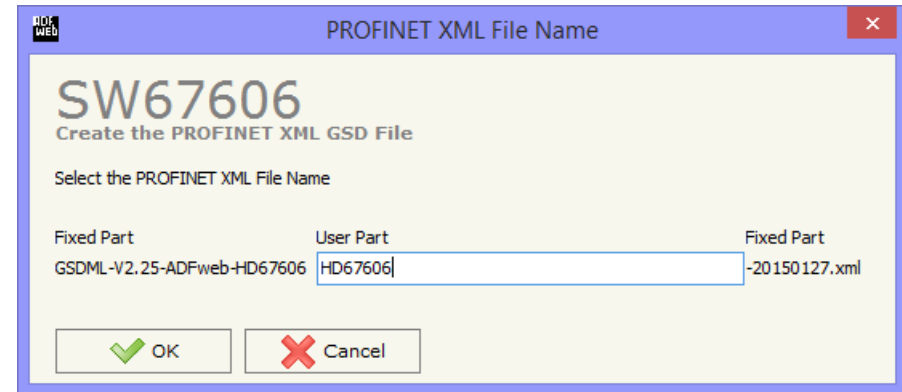

Figure 7: “Send Frames Info” window

XML FILE:

By Pressing the “**PROFINET XML**” button from the main window for SW67606 (Fig. 2) it is possible to generate the xml file to be imported into the master PROFINET.

Figure 8: “PROFINET XML File Name” window



UPDATE DEVICE:

By pressing the **"Update Device"** button, it is possible to load the created Configuration into the device; and also the Firmware, if necessary.

If you don't know the actual IP address of the device you have to use this procedure:

- Turn off the Device;
- Put Dip1 of 'Dip-Switch A' in ON position;
- Turn on the device
- Connect the Ethernet cable;
- Insert the IP **"192.168.2.205"**;
- Press the **"Ping"** button, "Device Found!" must appear;
- Press the **"Next"** button;
- Select which operations you want to do;
- Press the **"Execute update firmware"** button to start the upload;
- When all the operations are "OK" turn off the Device;
- Put Dip1 of 'Dip-Switch A' at OFF position;
- Turn on the device.

At this point the configuration/firmware on the device is correctly updated.

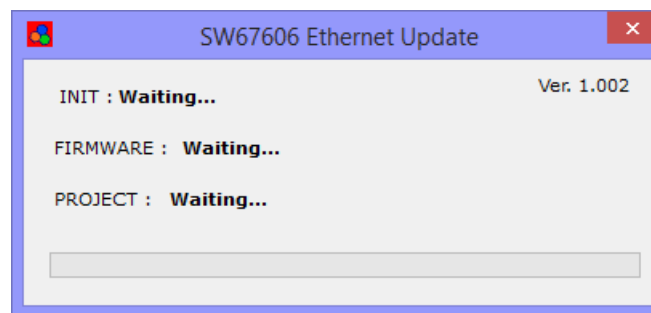
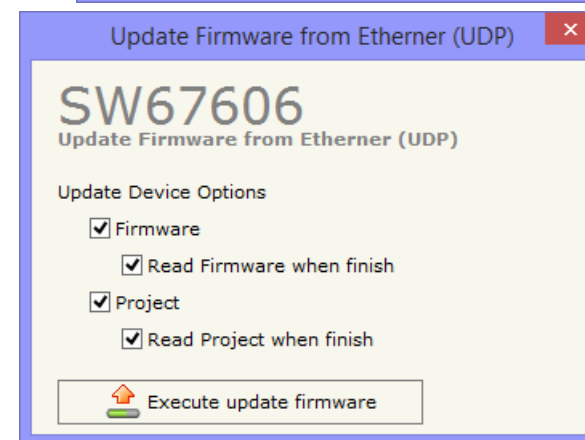
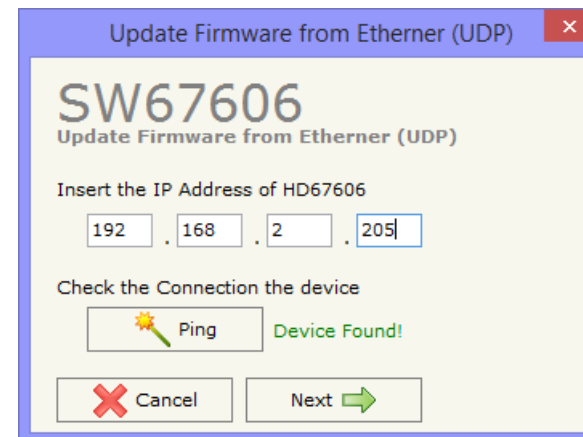



Figure 9: "Update device" windows

If you know the actual IP address of the device, you have to use this procedure:

- Turn on the Device with the Ethernet cable inserted;
- Insert the actual IP of the Converter;
- Press the "**Ping**" button, must appear "Device Found!";
- Press the "**Next**" button;
- Select which operations you want to do;
- Press the "**Execute update firmware**" button to start the upload;
- When all the operations are "OK" the device automatically goes at Normal Mode.

At this point the configuration/firmware on the device is correctly update.

 **Note:**
When you install a new version of the software, if it is the first time it is better you do the update of the Firmware in the HD67606-A1 device.

 **Note:**
When you receive the device, for the first time, you also have to update the Firmware in the HD67606-A1 device.

 **Warning:**
If Fig. 10 appears when you try to do the Update try these points before seeking assistance:

- Try to repeat the operations for the updating;
- Try with another PC;
- Try to restart the PC;
- If you are using the program inside a Virtual Machine, try to use in the main Operating System;
- If you are using Windows Seven or Vista or 8, make sure that you have the administrator privileges;
- Take attention at Firewall lock;
- Check the LAN settings.

 In the case of HD67606-A1 you have to use the software "SW67606": www.adfweb.com/download/filefold/SW67606.zip.

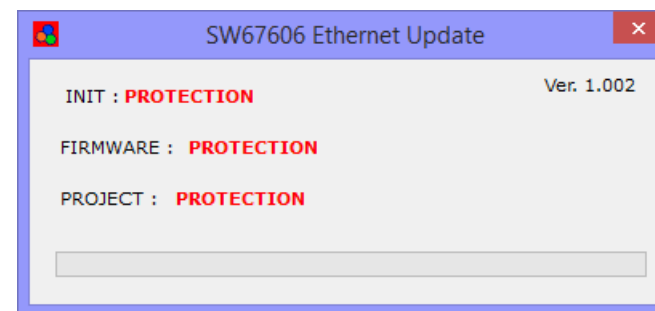

Figure 10: "Protection" window

SENDING ASYNCHRONOUS CAN MESSAGES FROM ETHERNET

The converter allows to send asynchronous CAN messages (for example a NMT message) directly from Ethernet to CANopen. The Ethernet message to send to the converter must have this structure:

Byte Number	Description
1÷4	COB-ID of the CAN message to send
5÷(4+n)	Data of the CAN message

n=Number of Byte to Write

To choose the type of CAN (2.0A or 2.0B) of the frame that the converter will send, it is necessary to put the most significant bit of the byte 1 to:

- 0: CAN 2.0A;
- 1: CAN 2.0B.

To send a CAN message from Ethernet to CAN, it is necessary to send the UDP message to the tunneling port of the converter.

Example:

We want to send the CAN message with these characteristics:
 CAN Type=2.0A; Frame: Cob_ID=0x0000; Data=0x0105.

So the string of hexadecimal numbers to be send to the converter is: [00][00][00][00][01][05].



Note:

After sending the first CAN messages, if the "Send back CAN messages" option is activated, the CAN messages are sent via Ethernet (UDP messages) with the same structure.

If the option "Send Back CAN messages" is not activated, it is possible to enable/disable it by sending the following UDP messages to the Tunneling Port:

Byte 0	Byte 1
0xB3	Enabling/disabling the Transparent Mode

0x01 = Function disabled

0x00 = Function enabled

If the command message is received correctly, the same message is sent back from the converter.

MECHANICAL DIMENSIONS:

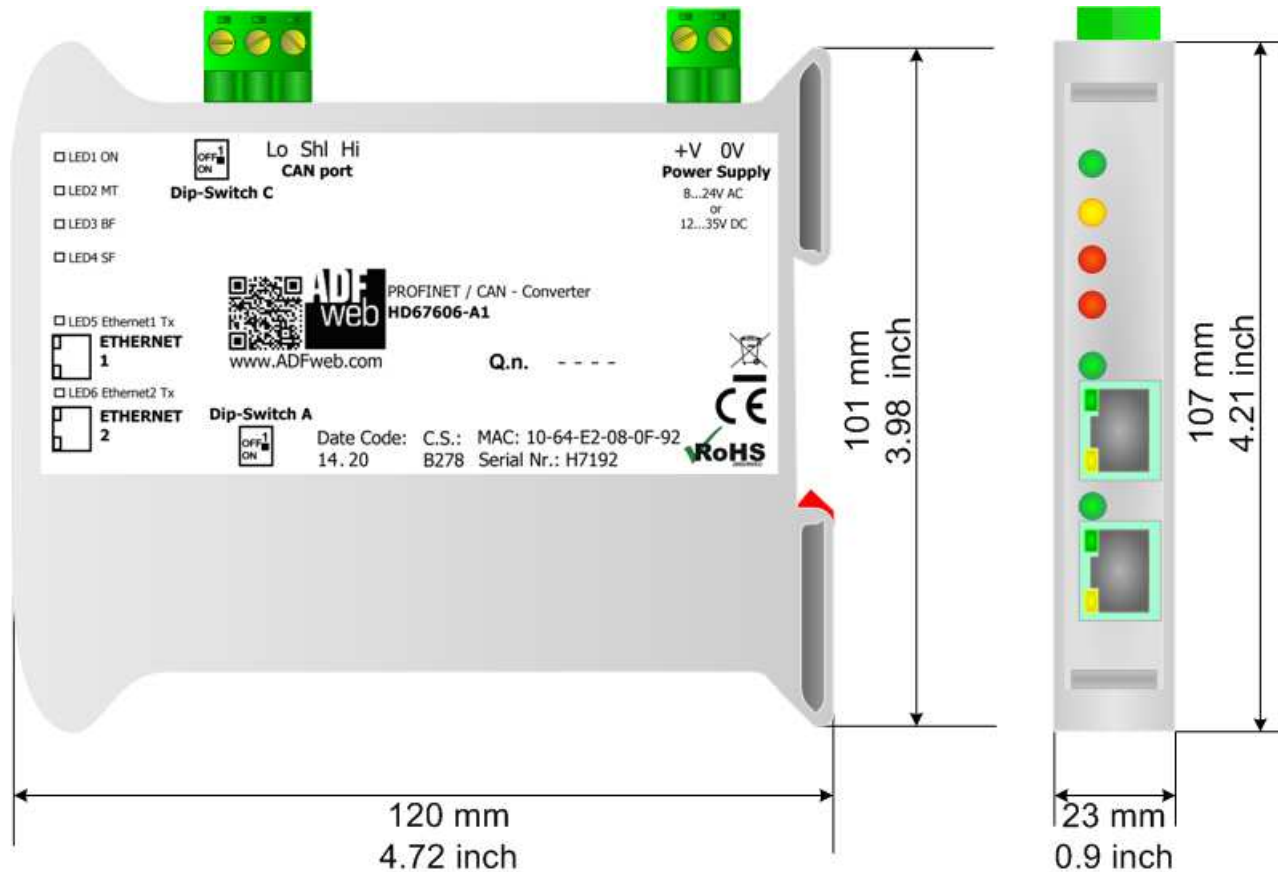

Housing: PVC
 Weight: 200g (Approx)

Figure 11: Mechanical dimensions scheme for HD67606-A1

ORDERING INFORMATIONS:

The ordering part number is formed by a valid combination of the following:

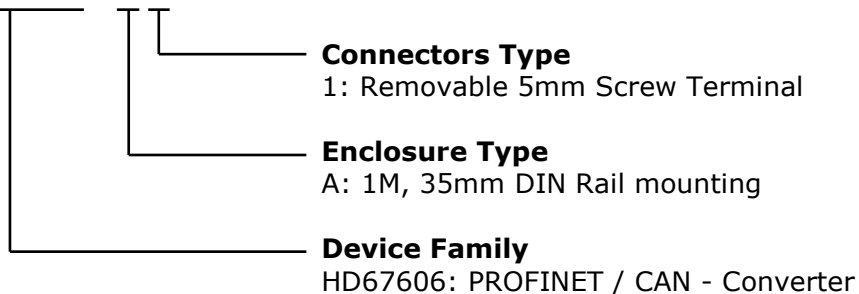
HD67606 – A 1

Order Code: **HD67606-A1** - PROFINET / CAN - Converter

ACCESSORIES:

Order Code: **AC34011** - Rail DIN - Power Supply 220/240V AC 50/60Hz – 12 V DC

Order Code: **AC34012** - Rail DIN - Power Supply 220/240V AC 50/60Hz – 24 V DC

PLC CONFIGURATION:

The configuration and commissioning of the PROFINET Converter as described on the following pages was accomplished with the help of the TIA Portal V12-software by Siemens. In the case of using a control system from another supplier, refer to attend to the associated documentation.

These are the steps to follow:

- 1) Install the description file of the module.

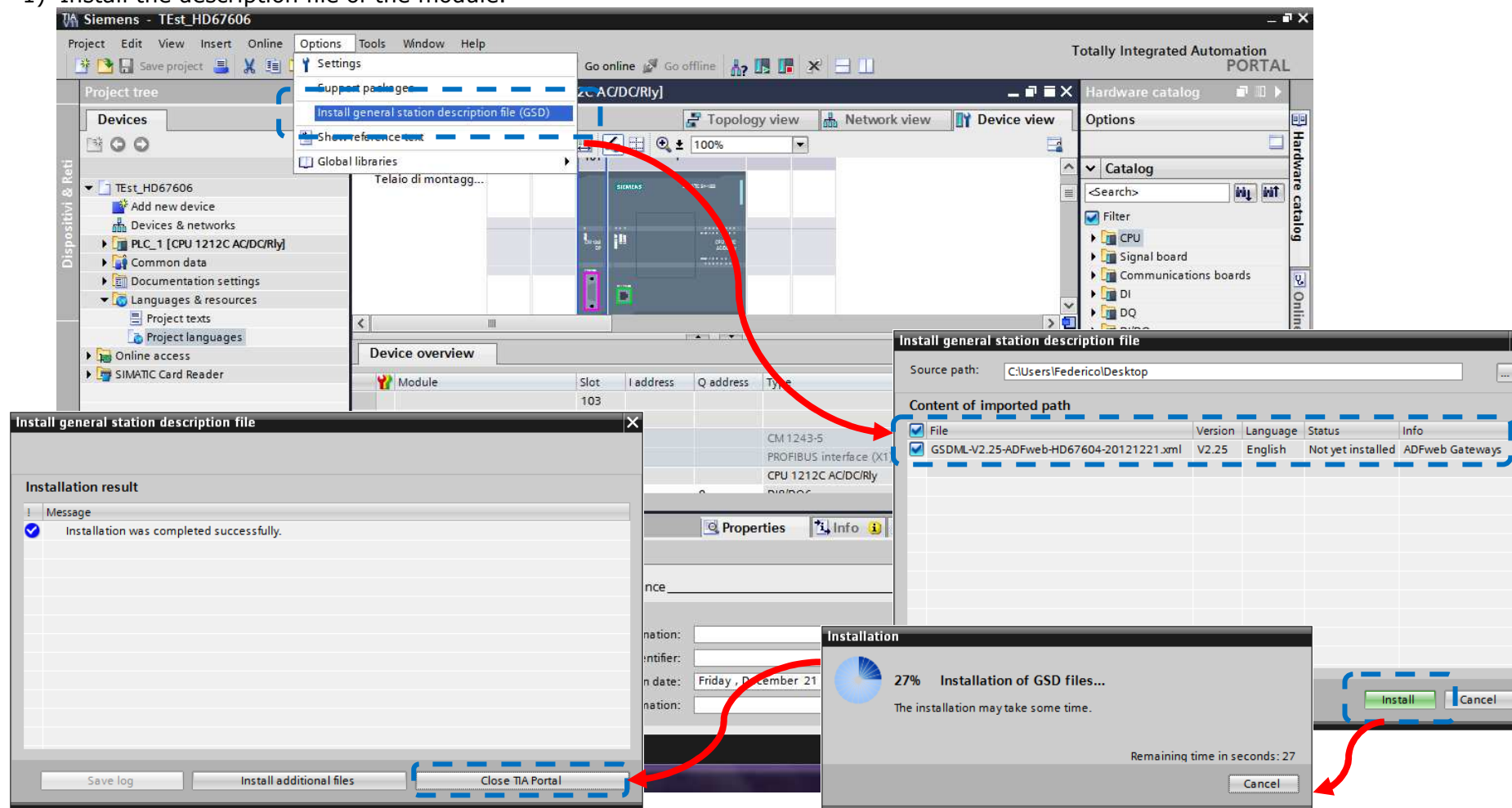

- 2) Press the “**Devices and networks**” button (1), from the right drop-down menu, under “Other field devices→PROFINET IO→Gateway→ADFWEB.com→HD67606” double click on “CAN” module (2).



Note:

If you have installed more than one xml file, go to the Information section and in the “Version” field select the correct xml file (3), before double clicking on “CAN” module

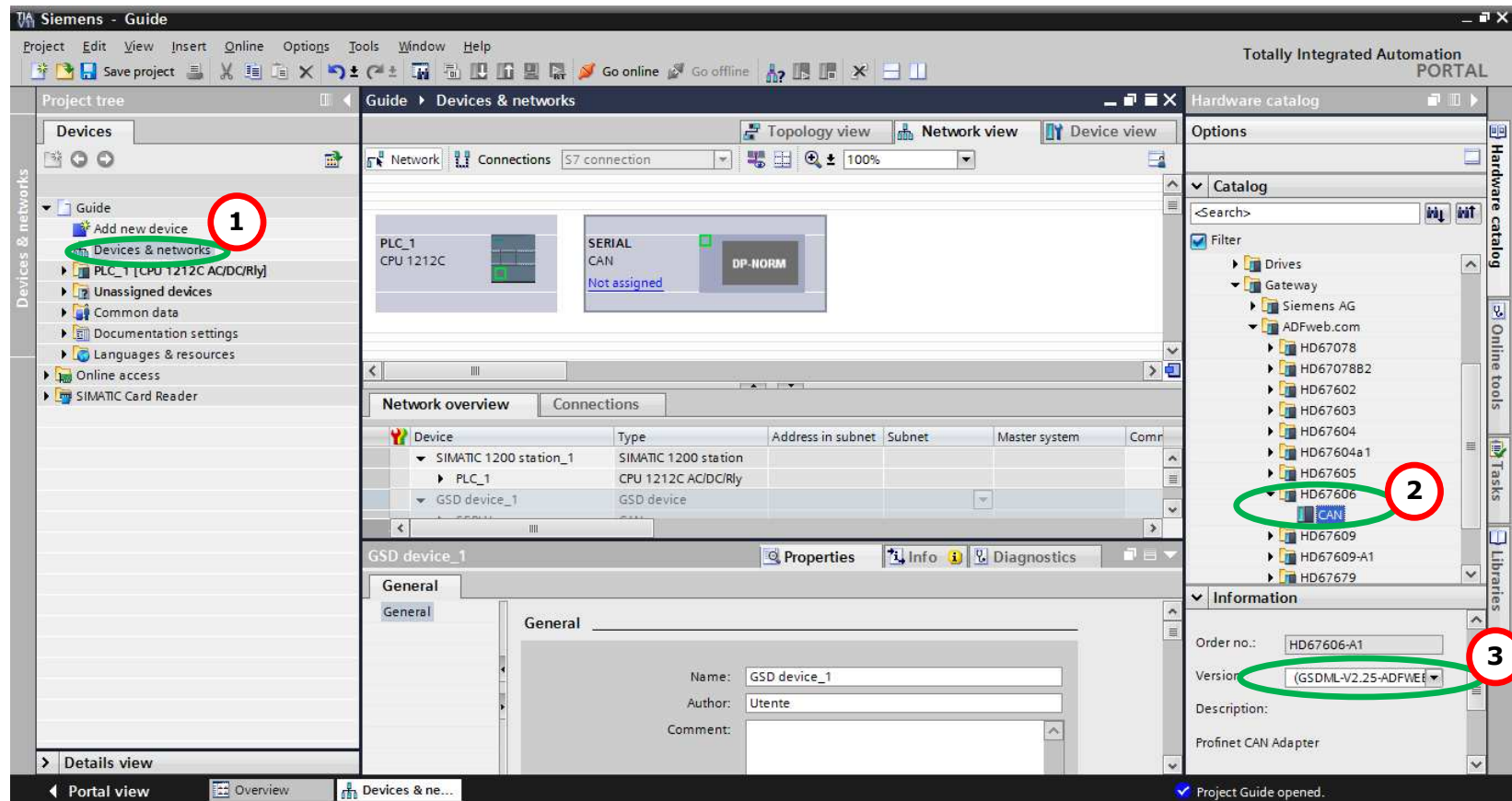

- 3) Connect the PLC to the HD67606 module by drawing the Ethernet wire between the two Ethernet ports. Then assign the IP Address **(1)** defined in the Compositor_SW67606 to the HD67606. Then double click the "Module" **(2)**.

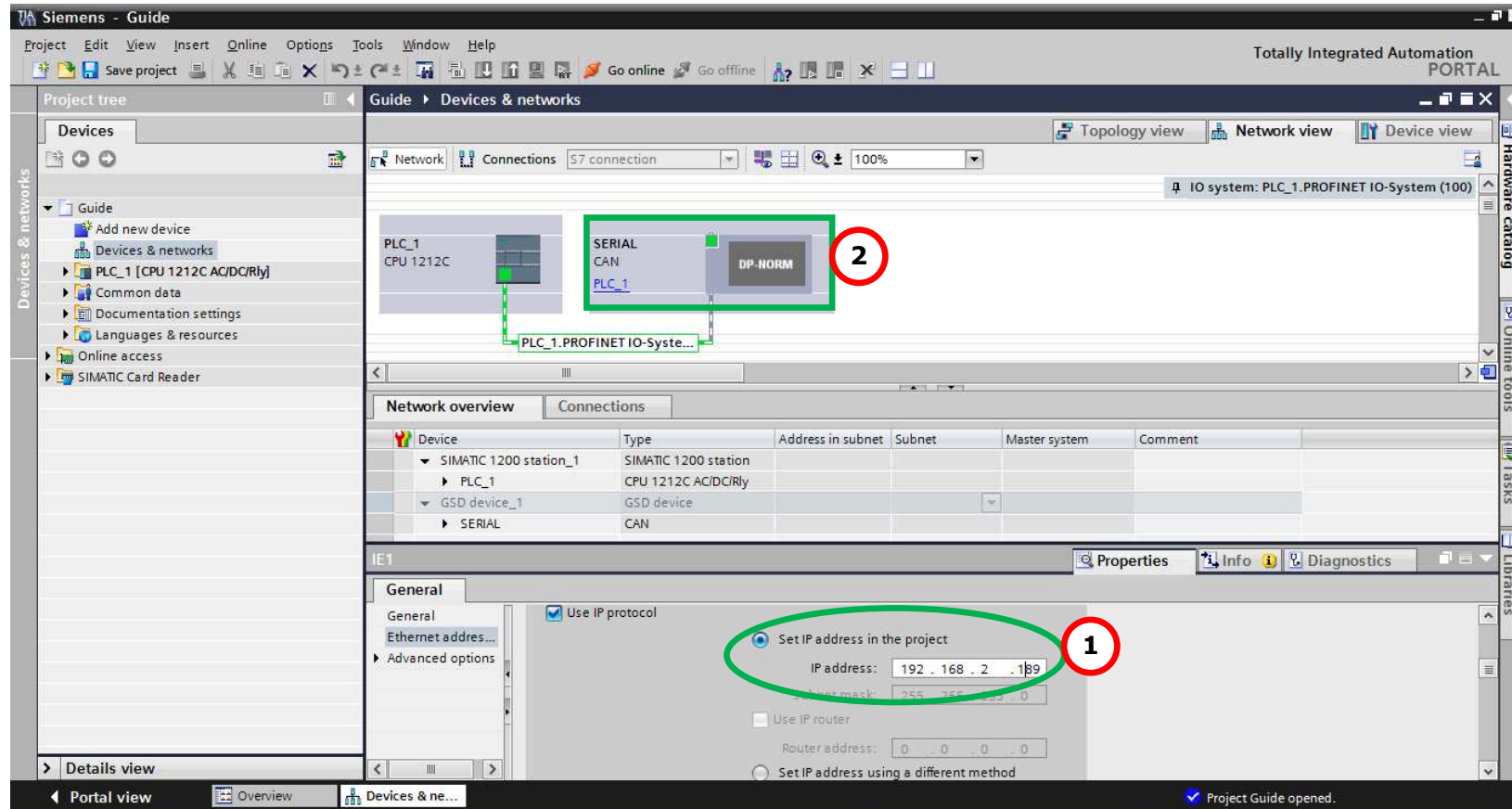

- 4) Then double click on the "Serial" label **(1)** and in the field name change it accordingly to the name defined in the Compositor_SW67606 **(2)**. Then add the main module "Module" and the sub-modules of "Digital Input" and "Digital Output" by double click on the three items in this order "Module" **(3)**, "Submodule 1" **(4)**, "Submodule 2" **(5)**.

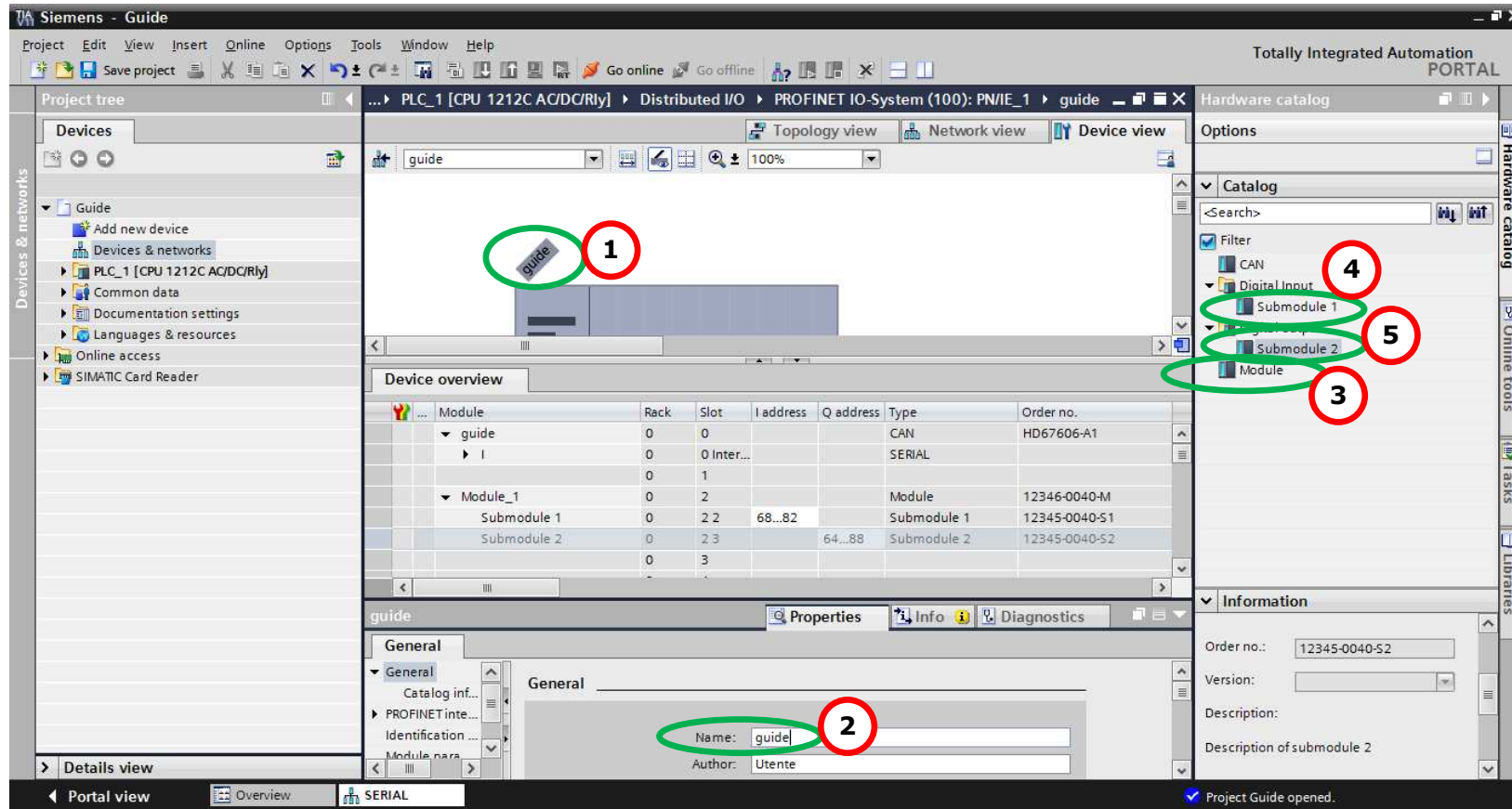

5) Load the configuration into the PLC.

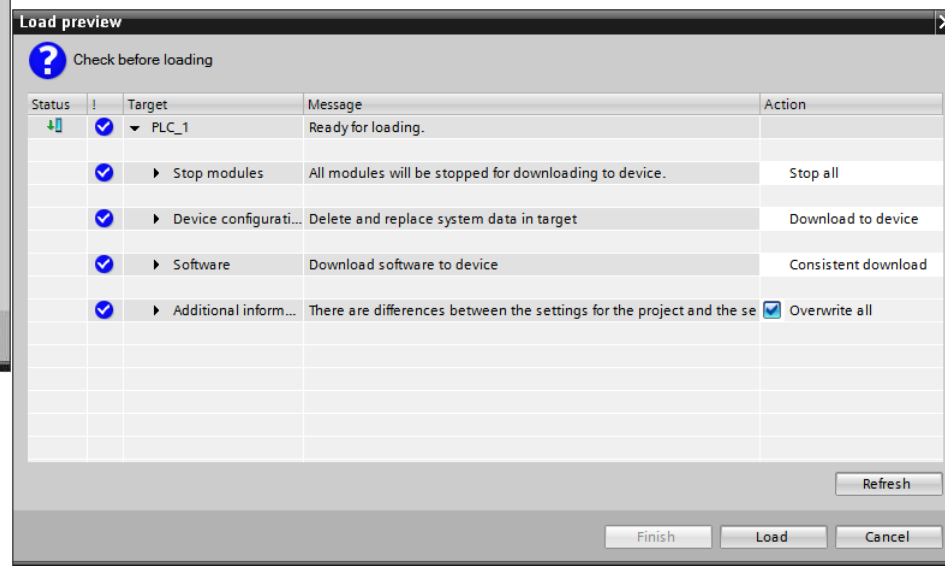
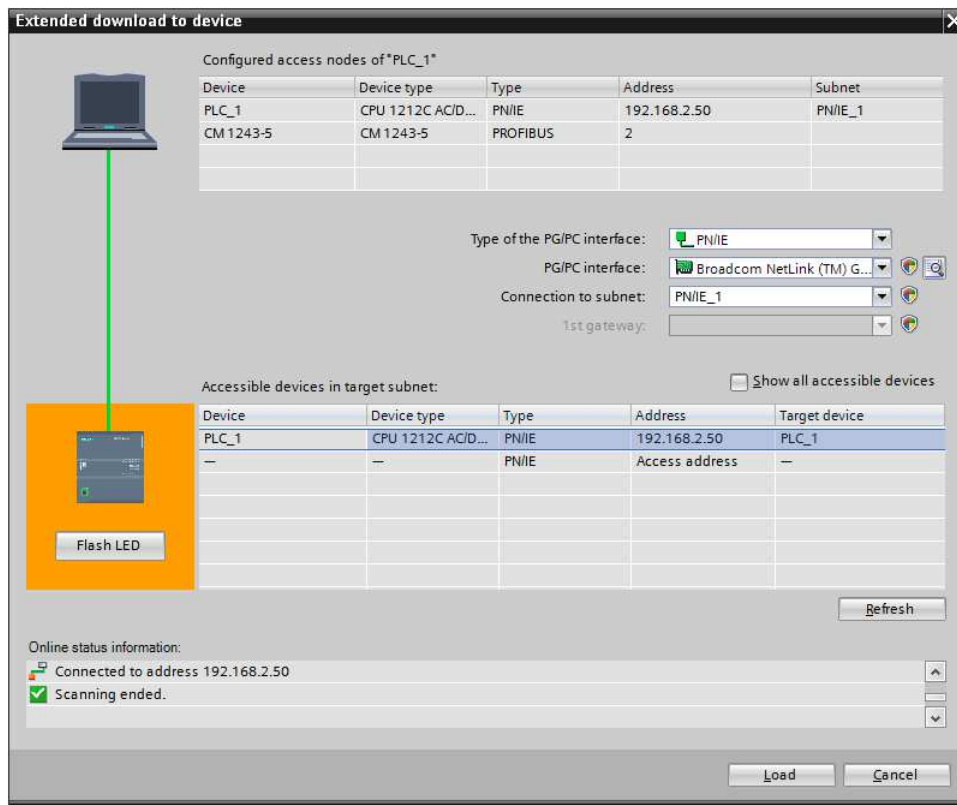

DISCLAIMER:

All technical content within this document can be modified without notice. The content of the document is a under continual renewal. For losses due to fire, earthquake, third party access or other accidents, or intentional or accidental abuse, misuse, or use under abnormal conditions repairs are charged to the user. ADFweb.com S.r.l. will not be liable for accidental loss of use or inability to use this product, such as loss of business income. ADFweb.com S.r.l. shall not be liable for consequences of improper use.

OTHER REGULATIONS AND STANDARDS:**WEEE INFORMATION**

Disposal of old electrical and electronic equipment (as in the European Union and other European countries with separate collection systems).

— This symbol on the product or on its packaging indicates that this product may not be treated as household rubbish. Instead, it should be taken to an applicable collection point for the recycling of electrical and electronic equipment. If the product is disposed correctly, you will help prevent potential negative environmental factors and impact of human health, which could otherwise be caused by inappropriate disposal. The recycling of materials will help to conserve natural resources. For more information about recycling this product, please contact your local city office, your household waste disposal service or the shop where you purchased the product.

RESTRICTION OF HAZARDOUS SUBSTANCES DIRECTIVE

The device respects the 2002/95/EC Directive on the restriction of the use of certain hazardous substances in electrical and electronic equipment (commonly referred to as Restriction of Hazardous Substances Directive or RoHS).

CE MARKING

The product conforms with the essential requirements of the applicable EC directives.

WARRANTIES AND TECHNICAL SUPPORT:

For fast and easy technical support for your ADFweb.com SRL products, consult our internet support at www.adfweb.com.
Otherwise contact us at the address support@adfweb.com

RETURN POLICY:

If while using your product you have any problem and you wish to exchange or repair it, please do the following:

- Obtain a Product Return Number (PRN) from our internet support at www.adfweb.com. Together with the request, you need to provide detailed information about the problem.
- Send the product to the address provided with the PRN, having prepaid the shipping costs (shipment costs billed to us will not be accepted).

If the product is within the warranty of twelve months, it will be repaired or exchanged and returned within three weeks. If the product is no longer under warranty, you will receive a repair estimate.

