

User Manual

Revision 1.001
English

PROFINET / J1939 - Converter

(Order Code: HD67610-A1)

for Website information:

Benefits and Main Features:

- ▶ Very easy to configure
- ▶ Electrical isolation
- ▶ Two PROFINET ports
- ▶ Temperature range: -40°C/85°C (-40°F/185°F)

Other Products →

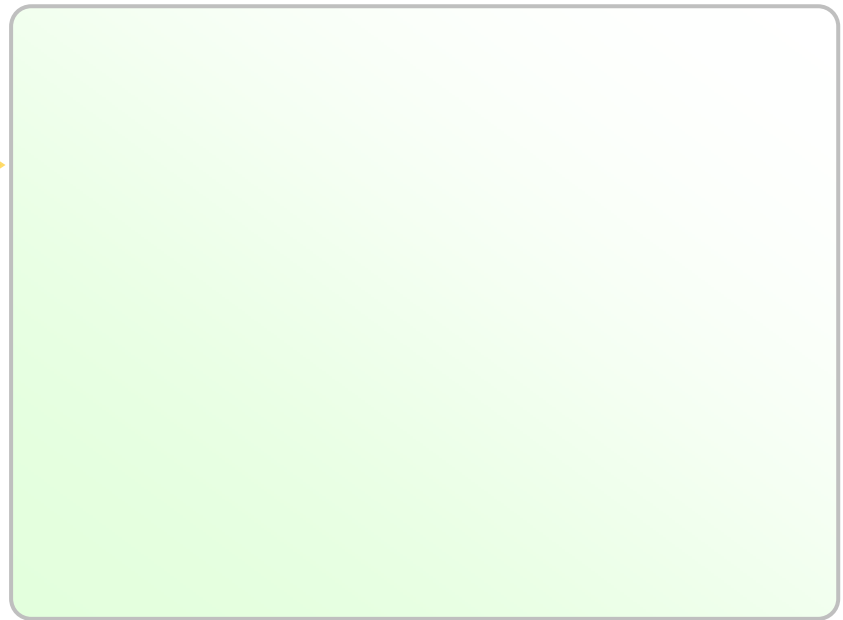

INDEX:

	Page
INDEX	2
UPDATED DOCUMENTATION	2
REVISION LIST	2
WARNING	2
TRADEMARKS	2
SECURITY ALERT	3
EXAMPLE OF CONNECTION	4
CONNECTION SCHEME	5
CHARACTERISTICS	6
CONFIGURATION	6
POWER SUPPLY	7
FUNCTION MODES	8
LEDS	9
PROFINET	10
J1939	11
USE OF COMPOSITOR SW67610	12
NEW PROJECT / OPEN PROJECT	12
SET COMMUNICATION	13
RECEIVE FRAMES	14
SEND FRAMES	15
UPDATE DEVICE	16
MECHANICAL DIMENSIONS	18
ORDERING INFORMATIONS	19
ACCESSORIES	19
PLC CONFIGURATION	20
DISCLAIMER	23
OTHER REGULATIONS AND STANDARDS	23
WARRANTIES AND TECHNICAL SUPPORT	24
RETURN POLICY	24

UPDATED DOCUMENTATION:

Dear customer, we thank you for your attention and we remind you that you need to check that the following document is:

- ✚ Updated
- ✚ Related to the product you own

To obtain the most recently updated document, note the “document code” that appears at the top right-hand corner of each page of this document.

With this “Document Code” go to web page www.adfweb.com/download/ and search for the corresponding code on the page. Click on the proper “Document Code” and download the updates.

To obtain the updated documentation for the product that you own, note the “Document Code” (Abbreviated written "Doc. Code" on the label on the product) and download the updated from our web site www.adfweb.com/download/

REVISION LIST:

Revision	Date	Author	Chapter	Description
1.000	18/09/2012	Dp	All	First Release
1.001	29/07/2013	Fl	All	Revision

WARNING:

ADFweb.com reserves the right to change information in this manual about our product without warning. ADFweb.com is not responsible for any error this manual may contain.

TRADEMARKS:

All trademarks mentioned in this document belong to their respective owners.

SECURITY ALERT:**GENERAL INFORMATION**

To ensure safe operation, the device must be operated according to the instructions in the manual. When using the device are required for each individual application, legal and safety regulation. The same applies also when using accessories.

INTENDED USE

Machines and systems must be designed so the faulty conditions do not lead to a dangerous situation for the operator (i.e. independent limit switches, mechanical interlocks, etc.).

QUALIFIED PERSONNEL

The device can be used only by qualified personnel, strictly in accordance with the specifications.

Qualified personnel are persons who are familiar with the installation, assembly, commissioning and operation of this equipment and who have appropriate qualifications for their job.

RESIDUAL RISKS

The device is state of the art and is safe. The instrument can represent a potential hazard if they are inappropriately installed and operated by personnel untrained. These instructions refer to residual risks with the following symbol:

 This symbol indicates that non-observance of the safety instructions is danger for people to serious injury or death and / or the possibility of damage.

CE CONFORMITY

The declaration is made by us. You can send an email to support@adfweb.com or give us a call if you need it.

EXAMPLE OF CONNECTION:

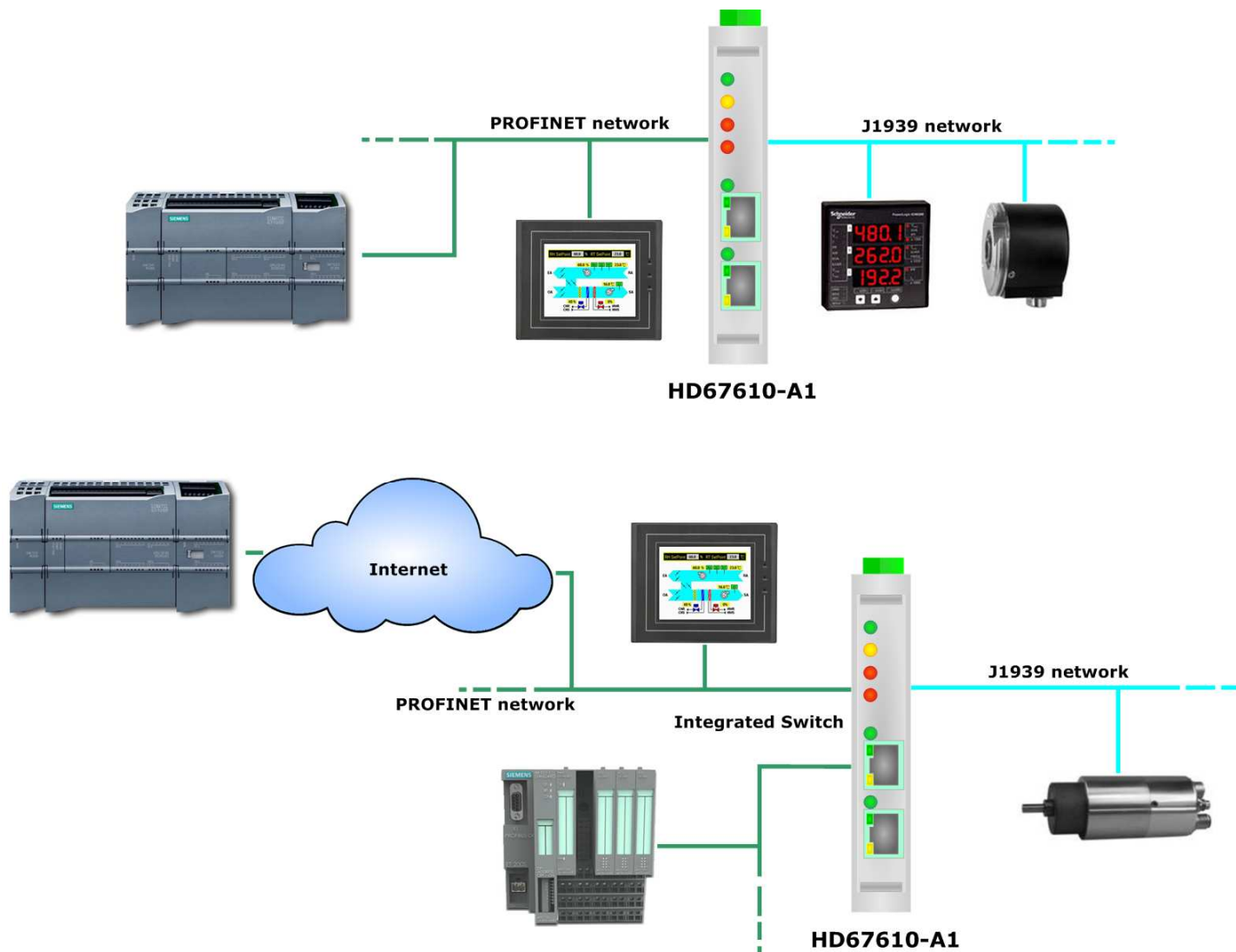

CONNECTION SCHEME:

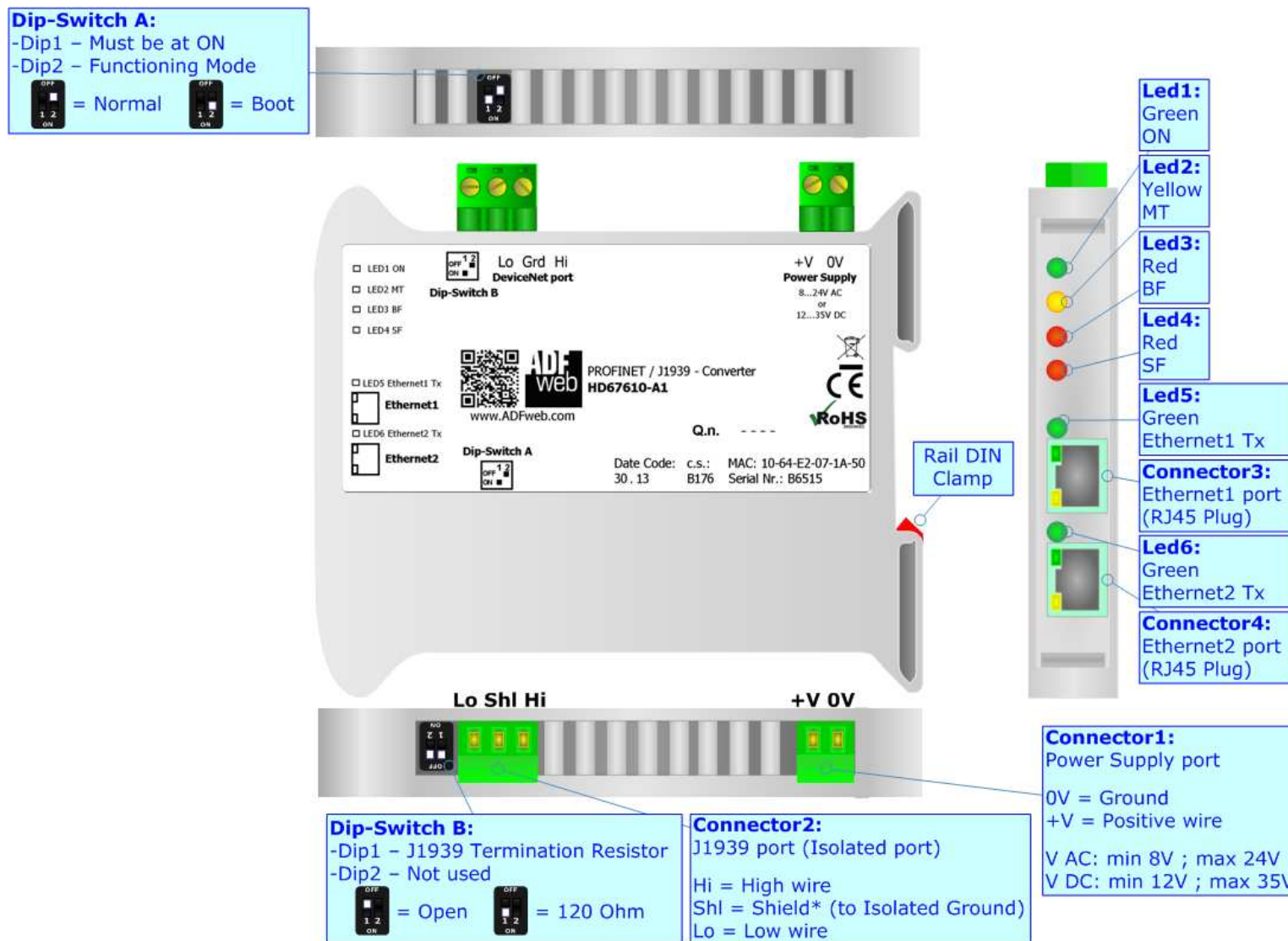

Figure 1: Connection scheme for HD67610-A1

CHARACTERISTICS:

The HD67610-A1 is a PROFINET / J1939 Converter.

It has the following characteristics:

- Up to 512 bytes in reading and 512 bytes in writing;
- Triple isolation between CAN - Power Supply, CAN - Ethernet, Power Supply - Ethernet.
- Two-directional information between J1939 bus and PROFINET bus;
- Mountable on 35mm Rail DIN;
- Wide power supply input range: 8...24V AC or 12...35V DC;
- Wide temperature range: -40°C / 85°C [-40°F / +185°F].

CONFIGURATION:

You need Compositor SW67610 software on your PC in order to perform the following:

- Define the parameter of PROFINET line;
- Define the parameter of CAN line;
- Define the J1939 frames that the Converter can accept;
- Define the J1939 frames that the Converter sends through the J1939 line;
- Update the device.

POWER SUPPLY:

The devices can be powered at 8...24V AC and 12...35V DC. For more details see the two tables below.

VAC		VDC	
Vmin	Vmax	Vmin	Vmax
8V	24V	12V	35V

Consumption at 24V DC:

Device	Consumption [W/VA]
HD67610-A1	3.5

Caution: Not reverse the polarity power

Connector1:
Power Supply port
0V = Ground
+V = Positive wire
V AC: min 8V ; max 24V
V DC: min 12V ; max 35V

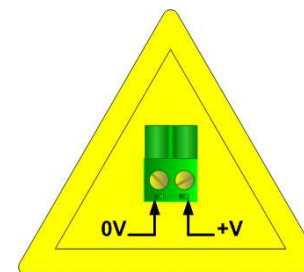
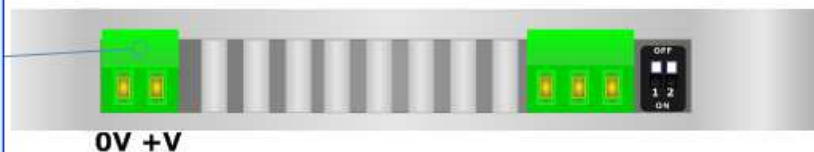

HD67610-A1

FUNCTION MODES:

The device has got two functions mode depending of the position of the 'Dip2 of Dip-Switch A':

- The first, with 'Dip2 of Dip-Switch A' at "OFF" position, is used for the normal working of the device.
- The second, with 'Dip2 of Dip-Switch A' at "ON" position, is used for upload the Project and/or Firmware.

For the operations to follow for the updating, see 'UPDATE DEVICE' section.

According to the functioning mode, the LEDs will have specifics functions, see 'LEDS' section.

**Warning:**

Dip1 of 'Dip-Switch A' must be at ON position for working even if the Ethernet cable isn't inserted.

LEDS:

The device has got six LEDs that are used to give information of the functioning status. The various meanings of the LEDs are described in the table below.

LED	Normal Mode	Boot Mode
1: ON [supply voltage] (green)	ON: Device powered OFF: Device not powered	ON: Device powered OFF: Device not powered
2: MT [maintenance display] (yellow)	ON: Maintenance Problem is present OFF: No maintenance are present	Blinks quickly: Boot state Blinks very slowly (~0.5Hz): update in progress
3: BF [bus fault] (red)	ON: The Ethernet connection is defective; the IP address exists several times in the network; the own NameOfStation exists several times in the network; no IP address has been set Flashing: At least one configured AR is no longer in the data exchange OFF: No errors are present	Blinks quickly: Boot state Blinks very slowly (~0.5Hz): update in progress
4: SF [group error] (red)	ON: At least one AR is not in the data exchange OFF: No errors are present	Blinks quickly: Boot state Blinks very slowly (~0.5Hz): update in progress
5: Ethernet1 Tx (green)	Blinks when is transmitting Ethernet frames	Blinks quickly: Boot state Blinks very slowly (~0.5Hz): update in progress
6: Ethernet2 Tx (green)	Blinks when is transmitting Ethernet frames	Blinks quickly: Boot state Blinks very slowly (~0.5Hz): update in progress

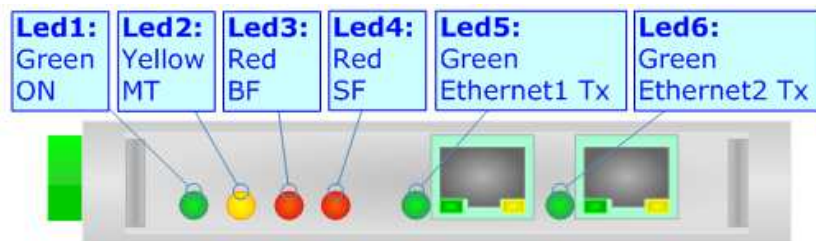

PROFINET:

The PROFINET connection must be made using Connector3 and/or Connector4 of HD67610-A1 with at least a Category 5E cable. The maximum length of the cable should not exceed 100m. The cable has to conform to the T568 norms relative to connections in cat.5 up to 100 Mbps. To connect the device to an Hub/Switch is recommended the use of a straight cable, to connect the device to a PC/PLC/other is recommended the use of a cross cable.

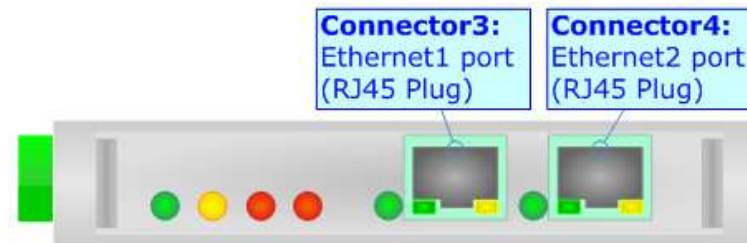

J1939:

For terminate the J1939 line with a 120Ω resistor it is necessary that the Dip1 of 'Dip-Switch B' is at ON position.

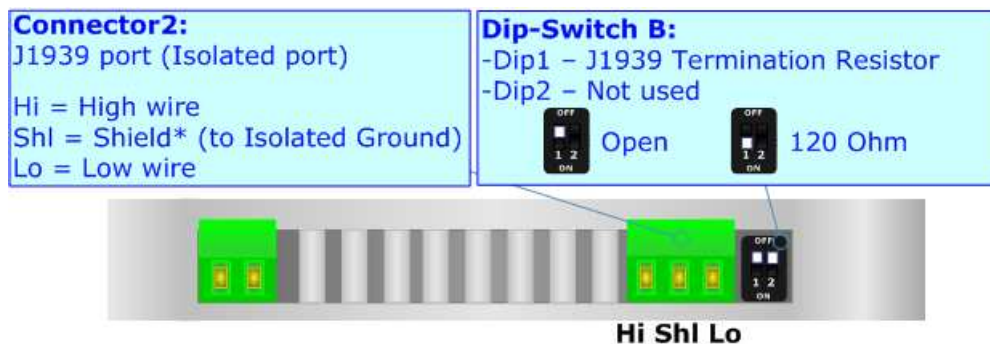

Cable characteristics:

DC parameter:	Impedance	70 Ohm/m
AC parameters:	Impedance	120 Ohm/m
	Delay	5 ns/m
Length	Baud Rate [bps]	Length MAX [m]
	10 K	5000
	20 K	2500
	50 K	1000
	100 K	650
	125 K	500
	250 K	250
	500 K	100
	800 K	50
	1000 K	25

USE OF COMPOSITOR SW67610:

To configure the Converter, use the available software that runs with Windows, called SW67610. It is downloadable on the site www.adfweb.com and its operation is described in this document. (This manual is referenced to the last version of the software present on our web site). The software works with MSWindows (MS 2000, XP, Vista, Seven, 8; 32/64bit).

When launching the SW67610 the right window appears (Fig. 2).

 **Note:**
It is necessary to have installed .Net Framework 4.

Figure 2: Main window for SW67610



NEW PROJECT / OPEN PROJECT:

The **“New Project”** button creates the folder which contains the entire device configuration.

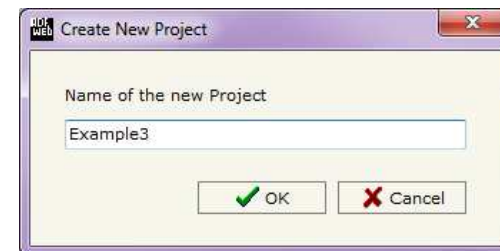
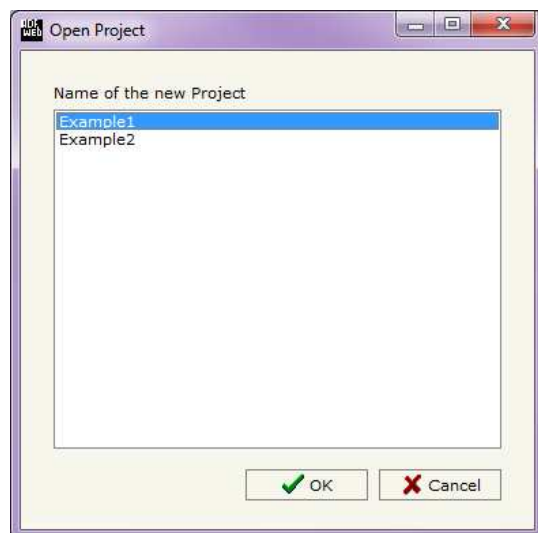

A device configuration can also be imported or exported:

- To clone the configurations of a programmable “PROFINET / J1939 – Converter” in order to configure another device in the same manner, it is necessary to maintain the folder and all its contents;
- To clone a project in order to obtain a different version of the project, it is sufficient to duplicate the project folder with another name and open the new folder with the button **“Open Project”**.

SET COMMUNICATION:

This section define the fundamental communication parameters of two buses, PROFINET and J1939.

By Pressing the "**Set Communication**" button from the main window for SW67610 (Fig. 2) the window "Set Communication" appears (Fig. 3).

The window is divided in two sections, one for the PROFINET and the other for the J1939.

The means of the fields for "PROFINET" are:

- In the fields "**IP ADDRESS**" insert the IP address that you want to give to the Converter;
- In the fields "**SUBNET Mask**" insert the SubNet Mask;
- In the fields "**GATEWAY**" insert the default gateway that you want to use. This feature can be enabled or disabled pressing the Check Box field. This feature is used for going out of the net;
- In the field "**Port**" the port used for PROFINET communication is defined. The port has a fixed value of 34964;
- In the field "**PROFINET Name of Station**" is possible to assign a name to the PROFINET node.

The means of the fields for the "J1939" section are:

- In the "**Baudrate**" field the J1939 baudrate is defined;
- In the field "**TimeOut Data**" insert a time; when this time is elapsed and the data isn't reliable, in the PROFINET data array you read "0". It is possible to use this function only for the "Receive Frames";
- If the field "**Enable Peer to Peer**" is checked, the gateway accepts all the ID that have the PGN inserted in the "Receive Frames" section.

The screenshot shows a window titled "Set Communication" with a close button in the top right. The window is divided into two main sections: "PROFINET" and "J1939".

PROFINET Section:

- IP ADDRESS:** Four input fields containing "192", ".168", ".0", ".10".
- SUBNET Mask:** Four input fields containing "255", ".255", ".255", ".0".
- GATEWAY:** A checkbox labeled "GATEWAY" is unchecked. Below it are four input fields containing "192", ".168", ".0", ".1".
- Port:** A single input field containing "34964".
- PROFINET Name of Station:** A text input field containing "devicename1".

J1939 Section:

- Baudrate:** A dropdown menu showing "250K".
- Time Out Data (s):** A text input field containing "5".
- Enable Peer to Peer:** A checkbox is unchecked.

At the bottom of the window are two buttons: "OK" with a green checkmark icon and "Cancel" with a red X icon.

Figure 3: "Set Communication" window



Note:

The number of Input byte and Output byte of PROFINET is calculated automatically by the Compositor in relation of the J1939 frames defined.

RECEIVE FRAMES:

By pressing the "Receive Frames" button from the main window for SW67610 (Fig. 2) the "Receive J1939 Frames" window appears (Fig. 4).

The J1939 frames inserted in this table contains the Output data of PROFINET. These frames are accepted by the gateway.

The data of the columns have the following meanings:

- In the field "Data Page" insert the Data Page, the value is 0 or 1 (usually is 0);
- In the field "PGN" insert the PGN of the data you would like to read from PROFINET to J1939 (it is an identifier);
- In the field "Source Address" insert the address of the device that sends the frame;
- If the field "Transport Protocol" is checked the frame use transport protocol functions;
- In the field "Start Byte" insert the byte which you would start read, this field is enable only when the field Transport Protocol is checked;
- In the field "N° Byte" insert the number of byte you would read, for example your start byte is 20 an N°byte is 10, you can read the byte from 20 to 30;
- If the field "Cancel Data" is checked, the data in the frame will be erased after the expiration of the "TimeOut Data" defined in "Set Communication" section;
- In the field "Mnemonic" it is possible to insert a brief description.

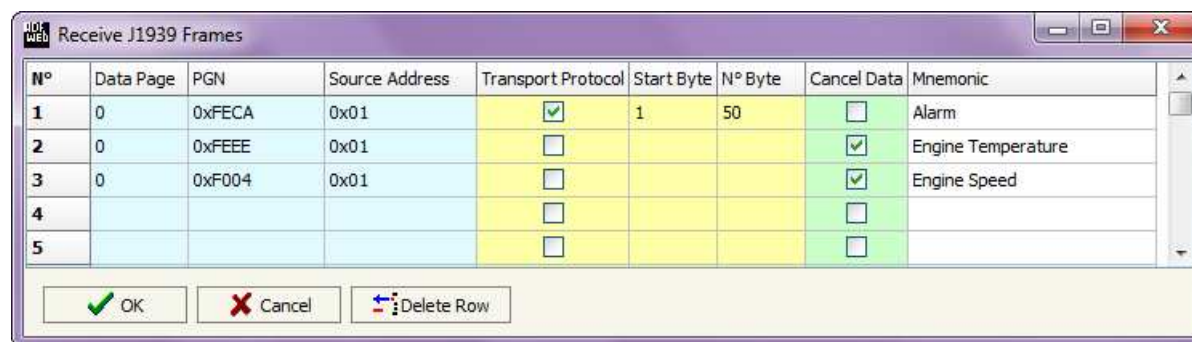

N°	Data Page	PGN	Source Address	Transport Protocol	Start Byte	N° Byte	Cancel Data	Mnemonic
1	0	0xFECA	0x01	<input checked="" type="checkbox"/>	1	50	<input type="checkbox"/>	Alarm
2	0	0xFEEE	0x01	<input type="checkbox"/>			<input checked="" type="checkbox"/>	Engine Temperature
3	0	0xF004	0x01	<input type="checkbox"/>			<input checked="" type="checkbox"/>	Engine Speed
4				<input type="checkbox"/>			<input type="checkbox"/>	
5				<input type="checkbox"/>			<input type="checkbox"/>	

Figure 4: "Receive J1939 Frames" window



Note:

It is possible to configure a maximum of 62 frames in the "Receive Frames" section.

SEND FRAMES:

By pressing the "Send Frames" button from the main window for SW67610 (Fig. 2) the "Send J1939 frames" window appears (Fig. 5).

The J1939 frames inserted in this table contains the Input data of PROFINET. These frames are sent by the gateway.

The data of the columns have the following meanings:

- In the field "Priority" insert the priority of the Frame: in J1939 protocol it is a number among 0,1,2,3,4,5,6,7. The number "0" is the highest priority and "7" is the lowest;
- In the field "Data Page" insert the data page, the value is 0 or 1 (usually is 0);
- In the field "PGN" insert the PGN of the data you would like to write from PROFINET to J1939 (in J1939 protocol the PGN is an identifier);
- In the field "Source Address" insert the address of the device that sends the frame;
- If the field "Transport Protocol" is checked the frame use transport protocol functions;
- In the field "Num Byte" the number of byte of the frame is defined, this field is enable only when the field Transport Protocol is checked;
- In the field "Transmission Type" is possible to select when send the J1939 frame. There are two options: the first is "On Data Change", the frame is sent when the data changes; the second is "On Timer" and the frame is send cyclically;
- In the field "Send Timer" insert the interval used for the "Send Frame Type → On Timer". The time is in milliseconds;
- In the field "Mnemonic" it is possible to insert a brief description.

N°	Priority	Data Page	PGN	Source Address	Transport Protocol	Num Byte	Transmission Type	Send Timer	Mnemonic
1	6	0	0x0000	0x01	<input type="checkbox"/>		On Timer	100	Speed Control
2	6	0	0xF008	0x02	<input type="checkbox"/>		On Data Change		
3					<input type="checkbox"/>				
4					<input type="checkbox"/>				
5					<input type="checkbox"/>				

Figure 5: "Send J1939 Frames" window



Note:

It is possible to configure a maximum of 62 frames in the "Send Frames" section.

UPDATE DEVICE:

By pressing the **"Update Device"** button it is possible to load the created Configuration into the device; and also the Firmware, if is necessary.

If you don't know the actual IP address of the device you have to use this procedure:

- Turn off the Device;
- Put Dip2 of 'Dip-Switch A' at ON position;
- Turn on the device
- Connect the Ethernet cable;
- Insert the IP **"192.168.2.205"**;
- Press the **"Ping"** button, must appear "Device Found!";
- Press the **"Next"** button;
- Select which operations you want to do;
- Press the **"Execute update firmware"** button to start the upload;
- When all the operations are "OK" turn off the Device;
- Put Dip2 of 'Dip-Switch A' at OFF position;
- Turn on the device.

At this point the configuration/firmware on the device is correctly updated.

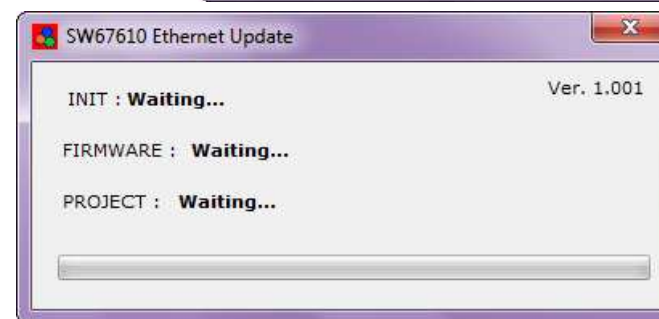
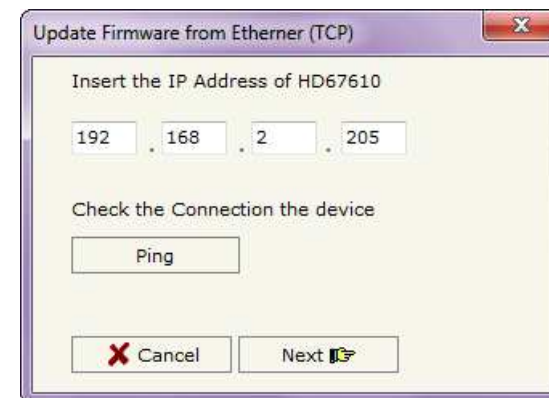

Figure 6: "Update device" windows

If you know the actual IP address of the device you have to use this procedure:

- Turn on the Device with the Ethernet cable inserted;
- Insert the actual IP of the Converter;
- Press the "**Ping**" button, must appear "Device Found!";
- Press the "**Next**" button;
- Select which operations you want to do;
- Press the "**Execute update firmware**" button to start the upload;
- When all the operations are "OK" the device automatically goes at Normal Mode.

At this point the configuration/firmware on the device is correctly update.



Note:

When you install a new version of the software it is better if the first time you do the update of the Firmware in the HD67610-A1 device.



Note:

When you receive the device, for the first time, you have to update also the Firmware in the HD67610-A1 device.



Warning:

If the Fig. 7 appears when you try to do the Update before require assistance try these points:

- Try to repeat the operations for the updating;
- Try with another PC;
- Try to restart the PC;
- If you are using the program inside a Virtual Machine, try to use in the main Operating System;
- If you are using Windows Seven or Vista or 8, make sure that you have the administrator privileges;
- Take attention at Firewall lock;
- Check the LAN settings.



In the case of HD67610-A1 you have to use the software "SW67610": www.adfweb.com/download/filefold/SW67610.zip.

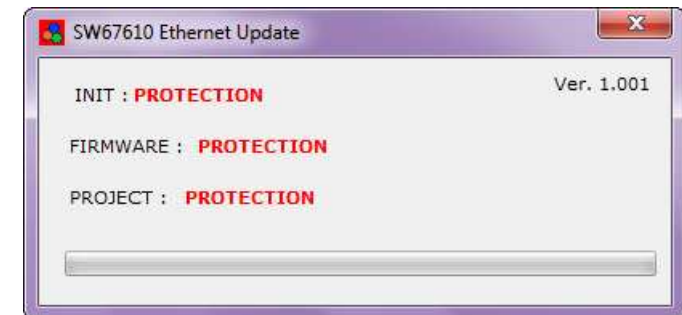
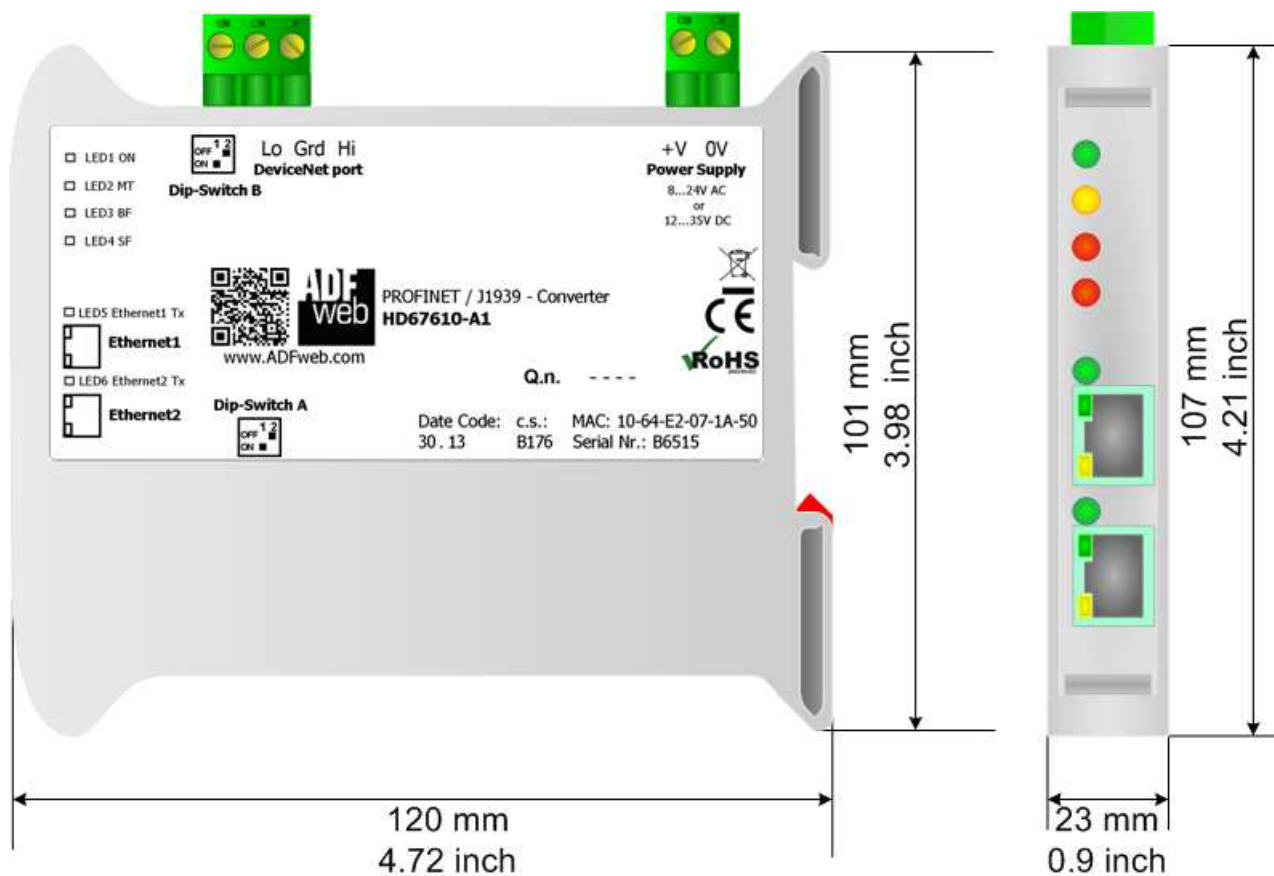

Figure 7: "Protection" window

MECHANICAL DIMENSIONS:



Housing: PVC
Weight: 200g (Approx)

Figure 8: Mechanical dimensions scheme for HD67610-A1

ORDERING INFORMATIONS:

The ordering part number is formed by a valid combination of the following:

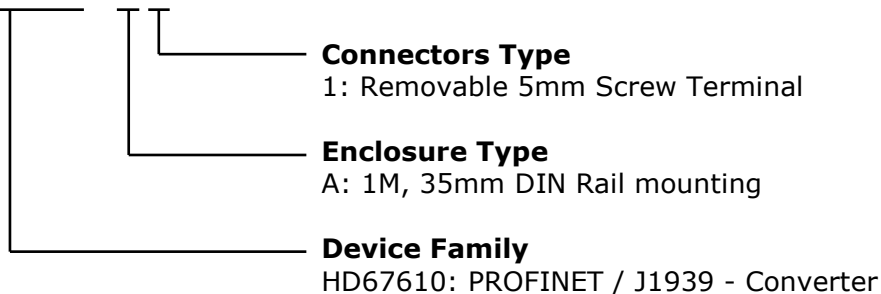
HD67610 - A 1

Order Code: **HD67610-A1** - PROFINET / J1939 - Converter

ACCESSORIES:

Order Code: **AC34001** - 35mm Rail DIN - Power Supply 220/240V AC 50/60Hz - 12 V AC

Order Code: **AC34002** - 35mm Rail DIN - Power Supply 110V AC 50/60Hz - 12 V AC

PLC CONFIGURATION:

The configuration and commissioning of the PROFINET Converter as described on the following pages was accomplished with the help of the TIA Portal V11-software of Siemens. In case of using a control system from another supplier please attend to the associated documentation. These are the steps to follow:

- 1) Install the description file of the module.

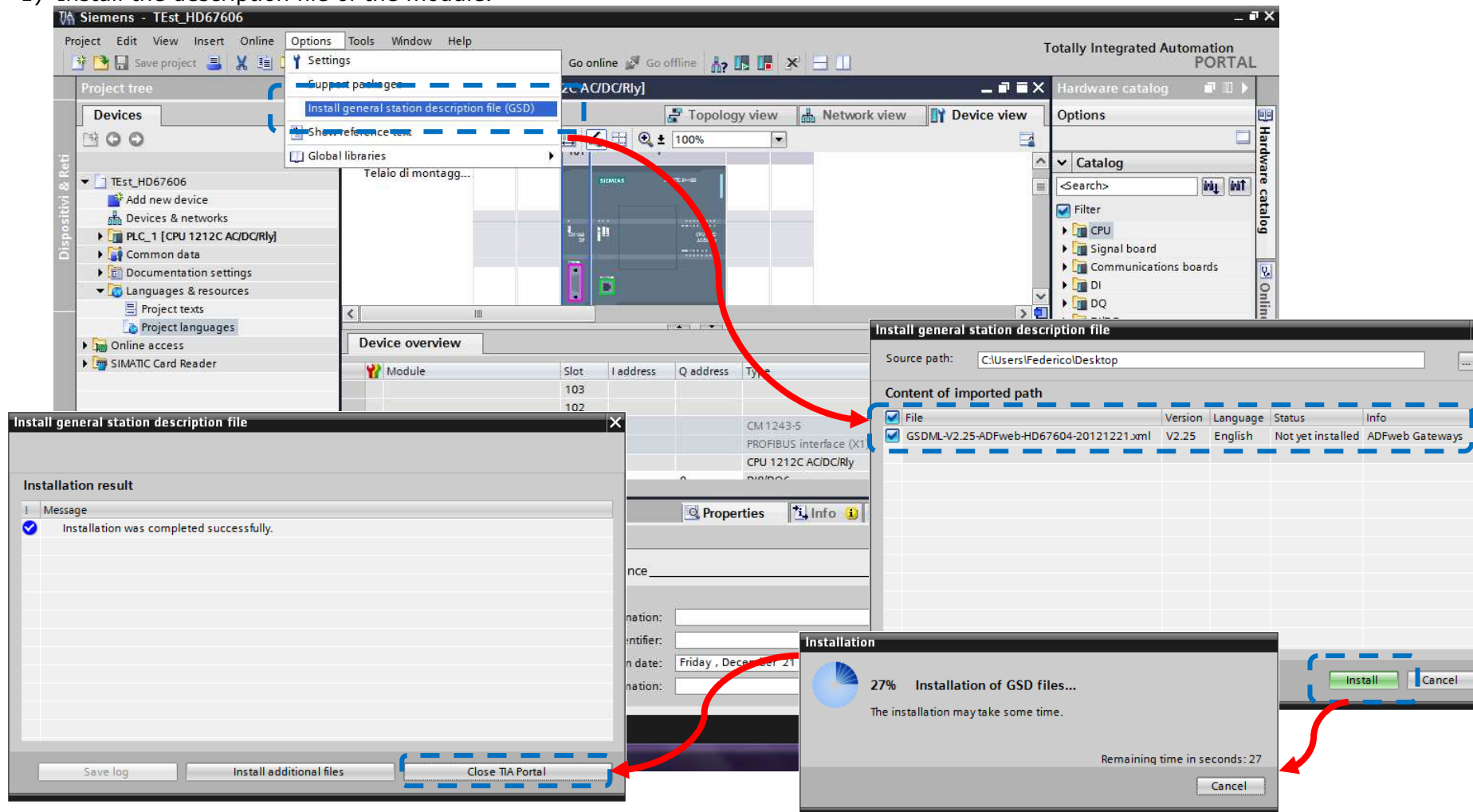

2) Import the module in the network; connect the device to the PLC network and edit the parameters of IP, station name etc.

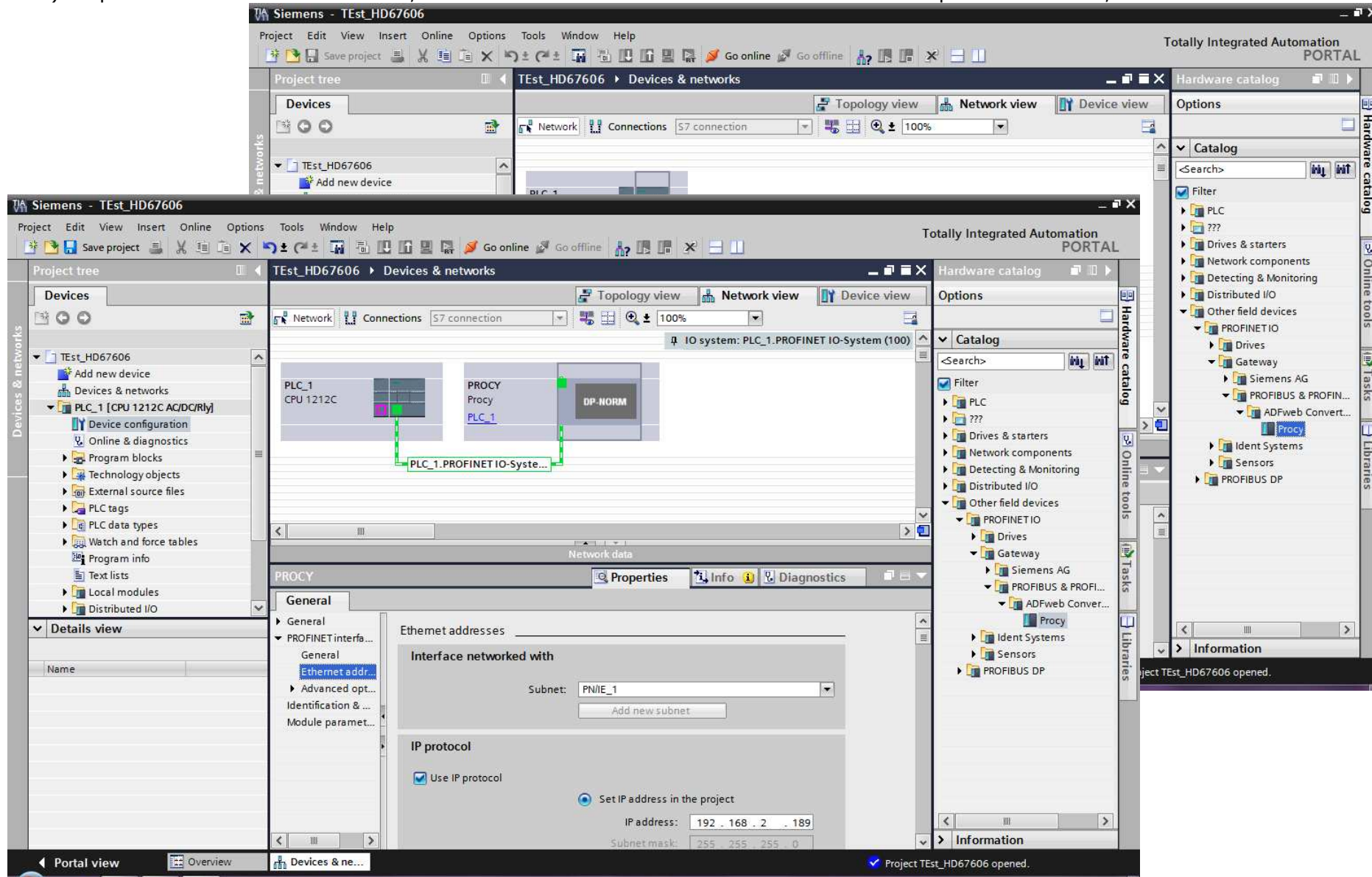

3) Load the configuration into the PLC.

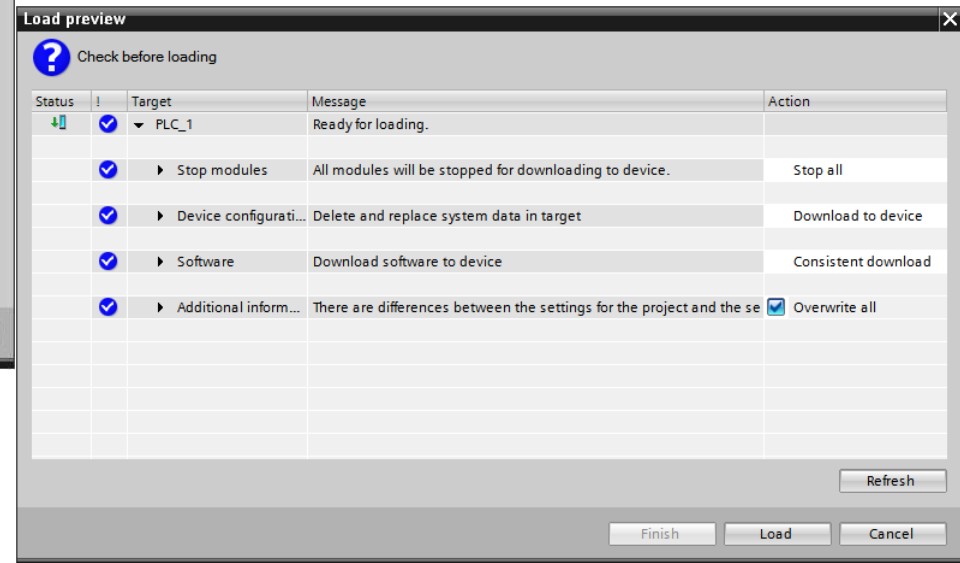
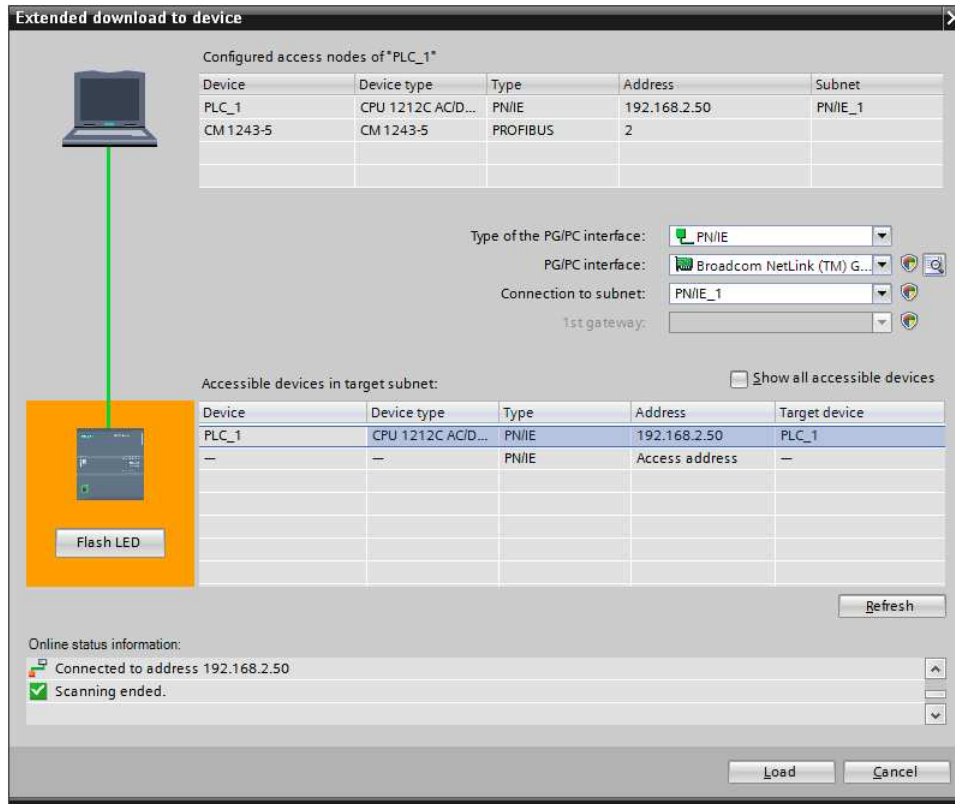

DISCLAIMER

All technical content within this document can be modified without notice. The content of the document content is a recurring audit. For losses due to fire, earthquake, third party access or other accidents, or intentional or accidental abuse, misuse, or use under abnormal conditions repairs are charged to the user. ADFweb.com S.r.l. will not be liable for accidental loss of use or inability to use this product, such as loss of business income. ADFweb.com S.r.l. shall not be liable for consequences of improper use.

OTHER REGULATIONS AND STANDARDS

WEEE INFORMATION



Disposal of old electrical and electronic equipment (as in the European Union and other European countries with separate collection systems).

— This symbol on the product or on its packaging indicates that this product may not be treated as household rubbish. Instead, it should be taken to an applicable collection point for the recycling of electrical and electronic equipment. If the product is disposed correctly, you will help prevent potential negative environmental factors and human health, which could otherwise be caused by inappropriate disposal. The recycling of materials will help to conserve natural resources. For more information about recycling this product, please contact your local city office, your household waste disposal service or the shop where you purchased the product.

RESTRICTION OF HAZARDOUS SUBSTANCES DIRECTIVE



The device respects the 2002/95/EC Directive on the restriction of the use of certain hazardous substances in electrical and electronic equipment (commonly referred to as Restriction of Hazardous Substances Directive or RoHS).

CE MARKING



The product conforms with the essential requirements of the applicable EC directives.



WARRANTIES AND TECHNICAL SUPPORT:

For fast and easy technical support for your ADFweb.com SRL products, consult our internet support at www.adfweb.com.
Otherwise contact us at the address support@adfweb.com

RETURN POLICY:

If while using your product you have any problem and you wish to exchange or repair it, please do the following:

- 1) Obtain a Product Return Number (PRN) from our internet support at www.adfweb.com. Together with the request, you need to provide detailed information about the problem.
- 2) Send the product to the address provided with the PRN, having prepaid the shipping costs (shipment costs billed to us will not be accepted).

If the product is within the warranty of twelve months, it will be repaired or exchanged and returned within three weeks. If the product is no longer under warranty, you will receive a repair estimate.