

## User Manual

Revision 1.002

English

### **PROFINET / Modbus Slave - Converter**

(Order Code: HD67603-232-A1, HD67603-485-A1)

#### **Benefits**

- ⊕ Triple electrical isolation
- ⊕ Two PROFINET ports
- ⊕ Temperature range: -40°C/+85°C (-40°F/+185°F)

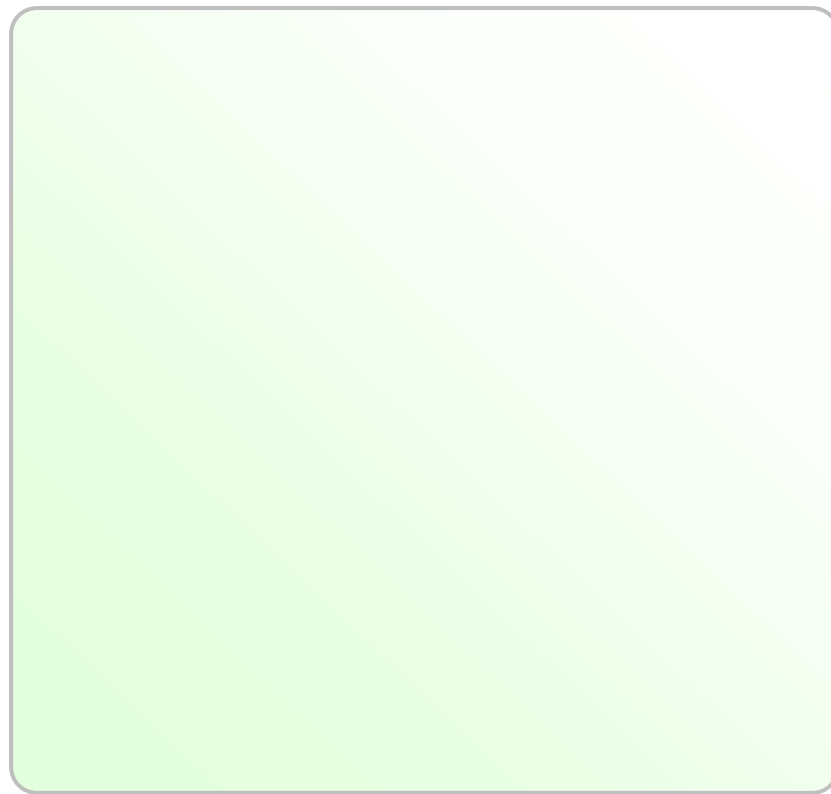

**INDEX:**

	Page
INDEX	2
UPDATED DOCUMENTATION	2
REVISION LIST	2
WARNING	2
TRADEMARKS	2
SECURITY ALERT	3
EXAMPLE OF CONNECTION	4
CONNECTION SCHEME	5
CHARACTERISTICS	7
CONFIGURATION	7
POWER SUPPLY	8
FUNCTION MODES	9
LEDS	10
PROFINET	11
RS232	11
RS485	12
USE OF COMPOSITOR SW67603	13
NEW PROJECT / OPEN PROJECT	14
SOFTWARE OPTIONS	15
SET COMMUNICATION	16
UPDATE DEVICE	17
MODBUS MAP	19
PLC CONFIGURATION	21
MECHANICAL DIMENSIONS	24
ORDERING INFORMATIONS	25
ACCESSORIES	25
DISCLAIMER	26
OTHER REGULATIONS AND STANDARDS	26
WARRANTIES AND TECHNICAL SUPPORT	27
RETURN POLICY	27

**UPDATED DOCUMENTATION:**

Dear customer, we thank you for your attention and we remind you that you need to check that the following document is:

- ✚ Updated
- ✚ Related to the product you own

To obtain the most recently updated document, note the “document code” that appears at the top right-hand corner of each page of this document.

With this “Document Code” go to web page [www.adfweb.com/download/](http://www.adfweb.com/download/) and search for the corresponding code on the page. Click on the proper “Document Code” and download the updates.

**REVISION LIST:**

Revision	Date	Author	Chapter	Description
1.000	14/09/2012	Dp	All	First Release
1.001	24/07/2013	Fl	All	Revision
1.002	11/04/2017	Ff	All	Revision

**WARNING:**

ADFweb.com reserves the right to change information in this manual about our product without warning. ADFweb.com is not responsible for any error this manual may contain.

**TRADEMARKS:**

All trademarks mentioned in this document belong to their respective owners.

**SECURITY ALERT:****GENERAL INFORMATION**

To ensure safe operation, the device must be operated according to the instructions in the manual. When using the device, legal and safety regulation are required for each individual application. The same applies also when using accessories.

**INTENDED USE**

Machines and systems must be designed so the faulty conditions do not lead to a dangerous situation for the operator (i.e. independent limit switches, mechanical interlocks, etc.).

**QUALIFIED PERSONNEL**

The device can be used only by qualified personnel, strictly in accordance with the specifications.

Qualified personnel are persons who are familiar with the installation, assembly, commissioning and operation of this equipment and who have appropriate qualifications for their job.

**RESIDUAL RISKS**

The device is state-of-the-art and is safe. The instruments can represent a potential hazard if they are inappropriately installed and operated by untrained personnel. These instructions refer to residual risks with the following symbol:



This symbol indicates that non-observance of the safety instructions is a danger for people that could lead to serious injury or death and / or the possibility of damage.

**CE CONFORMITY**

The declaration is made by our company. You can send an email to or give us a call if you need it.

**EXAMPLE OF CONNECTION:**

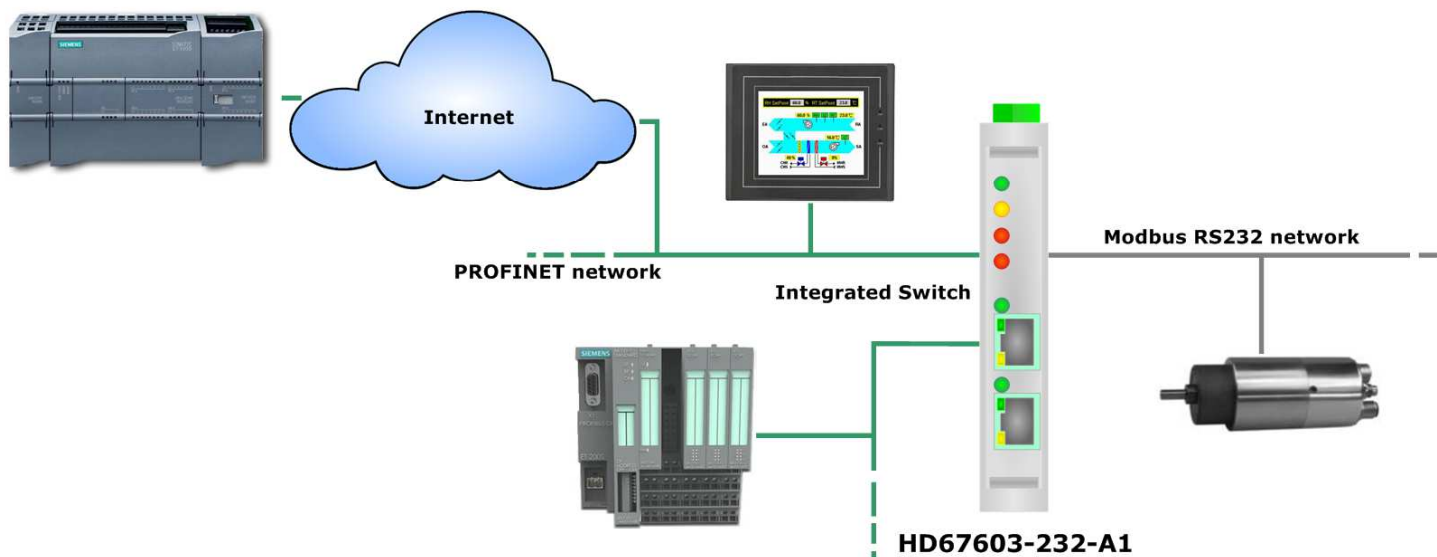
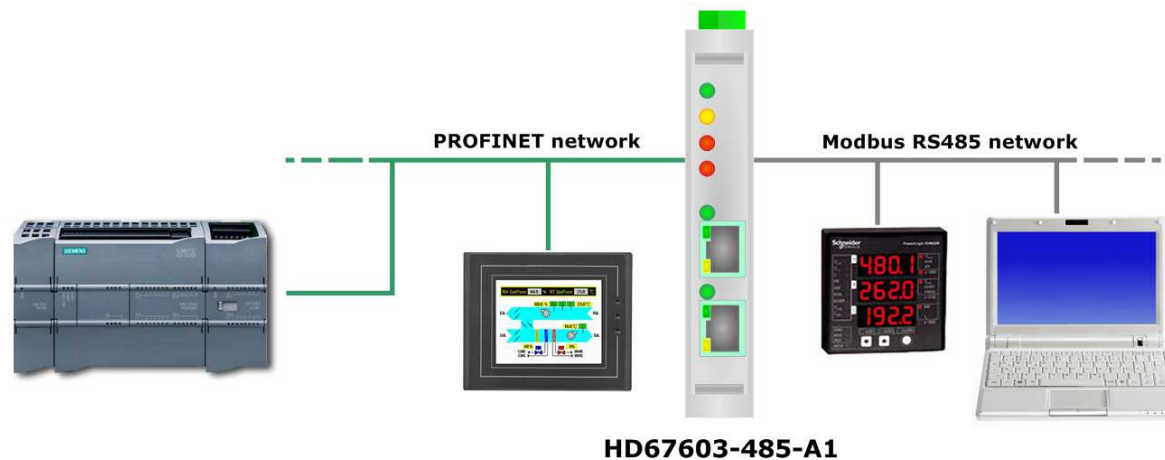

**CONNECTION SCHEME:**

**Dip-Switch A:**  
 -Dip1 – Must be at ON  
 -Dip2 – Functioning Mode

= Normal   
 = Boot

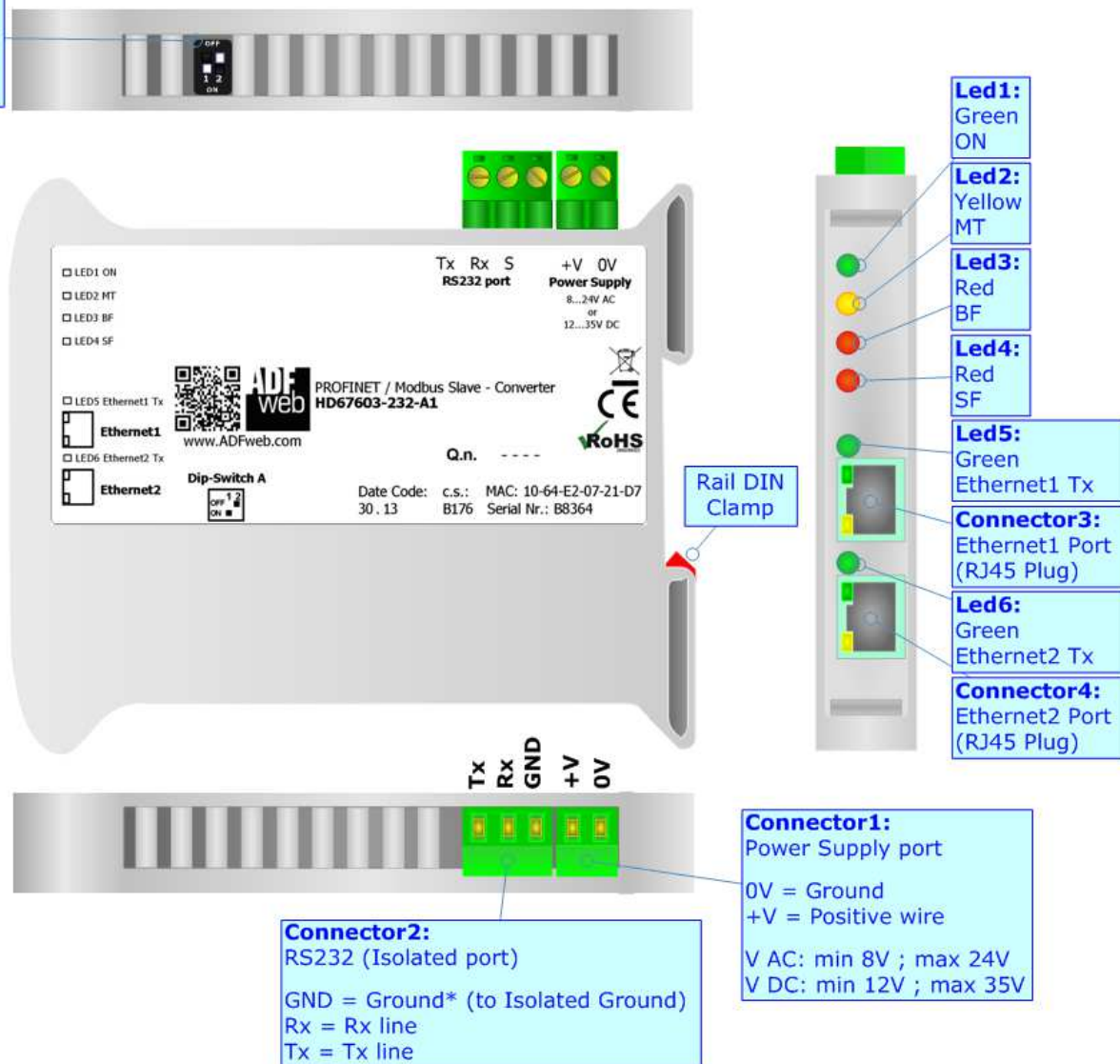

Figure 1a: Connection scheme for HD67603-232-A1

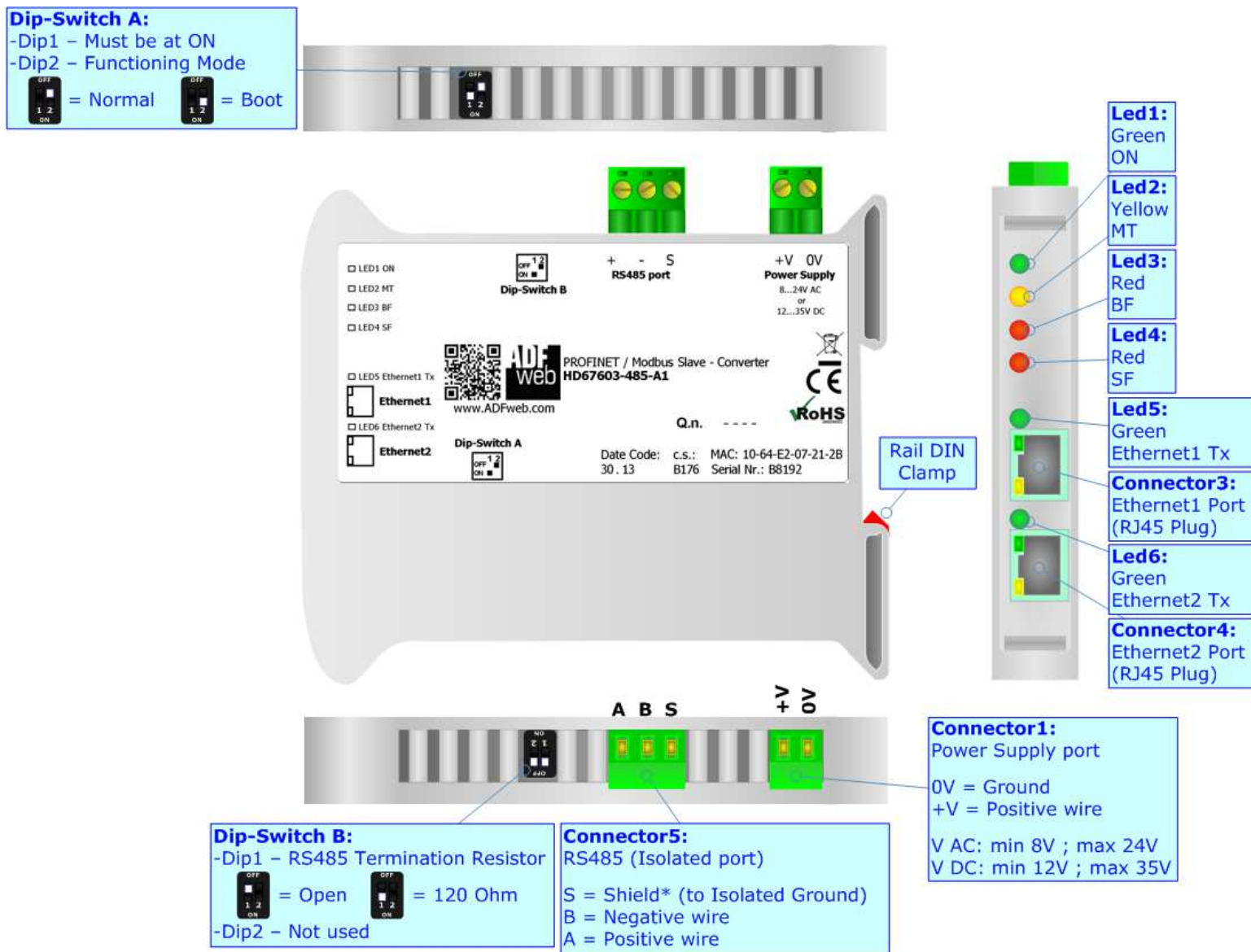

Figure 1b: Connection scheme for HD67603-485-A1

**CHARACTERISTICS:**

The HD67603 is a PROFINET / Modbus Slave - Converter.

They have the following characteristics:

- Up to 1440 bytes in reading and 1440 bytes in writing;
- Triple isolation between Modbus - Power Supply, Modbus - Ethernet, Power Supply - Ethernet.
- Two-directional information between Modbus bus and PROFINET bus;
- Mountable on 35mm Rail DIN;
- Wide power supply input range: 8...24V AC or 12...35V DC;
- Wide temperature range: -40°C / 85°C [-40°F / +185°F].

**CONFIGURATION:**

You need Compositor SW67603 software on your PC in order to perform the following:

- Define the parameter of PROFINET line;
- Define the parameter of Modbus line;
- Update the device.

**POWER SUPPLY:**

The devices can be powered at 8...24V AC and 12...35V DC. For more details see the two tables below.

VAC		VDC	
Vmin	Vmax	Vmin	Vmax
8V	24V	12V	35V

Consumption at 24V DC:

Device	Consumption [W/VA]
HD67603-232-A1	3.5
HD67603-485-A1	3.5

**Connector1:**  
Power Supply port  
0V = Ground  
+V = Positive wire  
V AC: min 8V ; max 24V  
V DC: min 12V ; max 35V

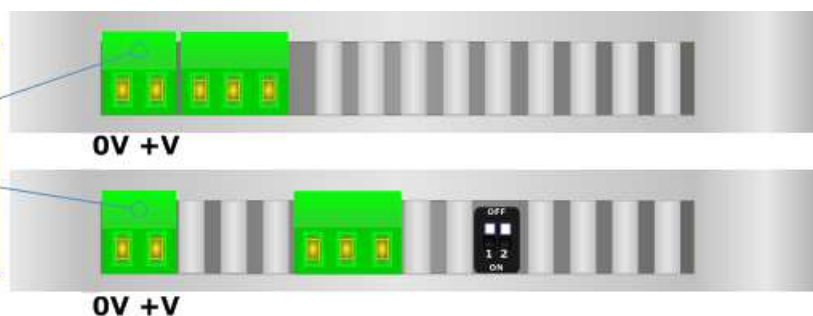

**Caution: Not reverse the polarity power**

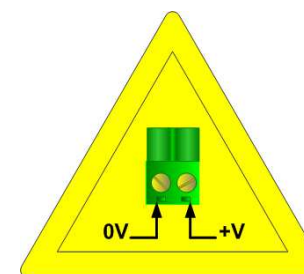

HD67603-xxx-A1



**FUNCTION MODES:**

The device has got two functions mode depending of the position of the 'Dip2 of Dip-Switch A':

- The first, with 'Dip2 of Dip-Switch A' at "OFF" position, is used for the normal working of the device.
- The second, with 'Dip2 of Dip-Switch A' at "ON" position, is used for upload the Project and/or Firmware.

For the operations to follow for the updating, see 'UPDATE DEVICE' section.

According to the functioning mode, the LEDs will have specifics functions, see 'LEDS' section.

**Warning:**

Dip1 of 'Dip-Switch A' must be at ON position for working even if the Ethernet cable isn't inserted.

**LEDS:**

The device has got six LEDs that are used to give information of the functioning status. The various meanings of the LEDs are described in the table below.

LED	Normal Mode	Boot Mode
1: ON [supply voltage ] (green)	<b>ON:</b> Device powered <b>OFF:</b> Device not powered	<b>ON:</b> Device powered <b>OFF:</b> Device not powered
2: MT [maintenance display] (yellow)	<b>ON:</b> Maintenance Problem is present <b>OFF:</b> No maintenance are present	<b>Blinks quickly:</b> Boot state <b>Blinks very slowly (~0.5Hz):</b> update in progress
3: BF [bus fault] (red)	<b>ON:</b> The Ethernet connection is defective; the IP address exists several times in the network; the own NameOfStation exists several times in the network; no IP address has been set <b>Flashing:</b> At least one configured AR is no longer in the data exchange <b>OFF:</b> No errors are present	<b>Blinks quickly:</b> Boot state <b>Blinks very slowly (~0.5Hz):</b> update in progress
4: SF [group error] (red)	<b>ON:</b> At least one AR is not in the data exchange <b>OFF:</b> No errors are present	<b>Blinks quickly:</b> Boot state <b>Blinks very slowly (~0.5Hz):</b> update in progress
5: Ethernet1 Tx (green)	Blinks when is transmitting Ethernet frames	<b>Blinks quickly:</b> Boot state <b>Blinks very slowly (~0.5Hz):</b> update in progress
6: Ethernet2 Tx (green)	Blinks when is transmitting Ethernet frames	<b>Blinks quickly:</b> Boot state <b>Blinks very slowly (~0.5Hz):</b> update in progress

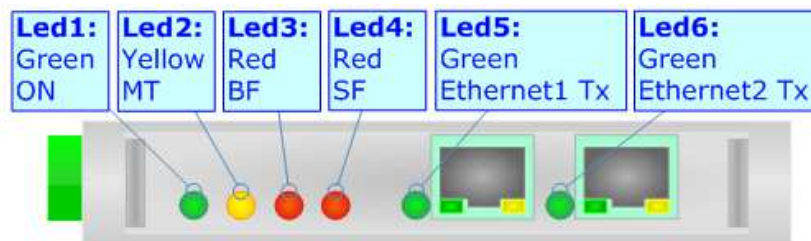

**PROFINET:**

The PROFINET connection must be made using Connector3 and/or Connector4 of HD67603-xxx-A1 with at least a Category 5E cable. The maximum length of the cable should not exceed 100m. The cable has to conform to the T568 norms relative to connections in cat.5 up to 100 Mbps. To connect the device to an Hub/Switch is recommended the use of a straight cable, to connect the device to a PC/PLC/other is recommended the use of a cross cable.

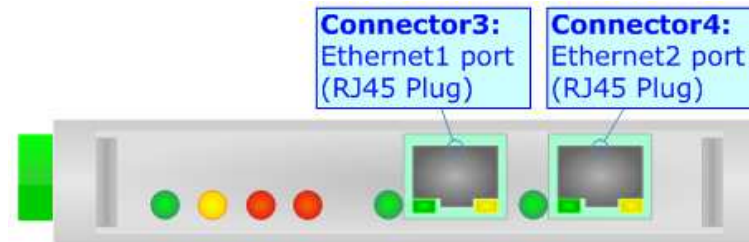

**RS232:**

The connection from RS232 socket to a serial port (example one from a personal computer) must be made with a NULL MODEM cable (a serial cable where the pins 2 and 3 are crossed). It is recommended that the RS232 cable not exceed 15 meters.

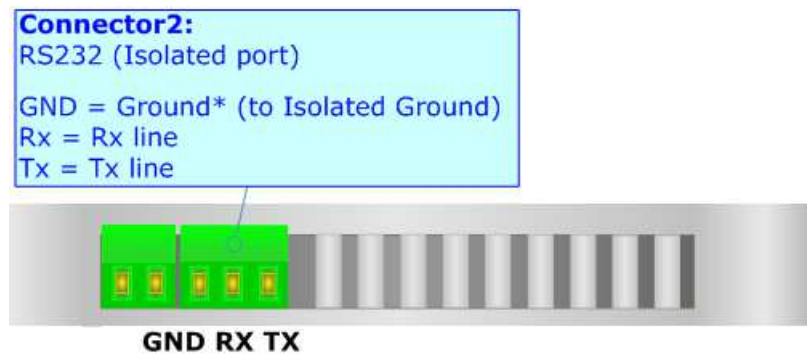

**RS485:**

For terminate the RS485 line with a 120Ω resistor it is necessary to put ON dip 1, like in figure.

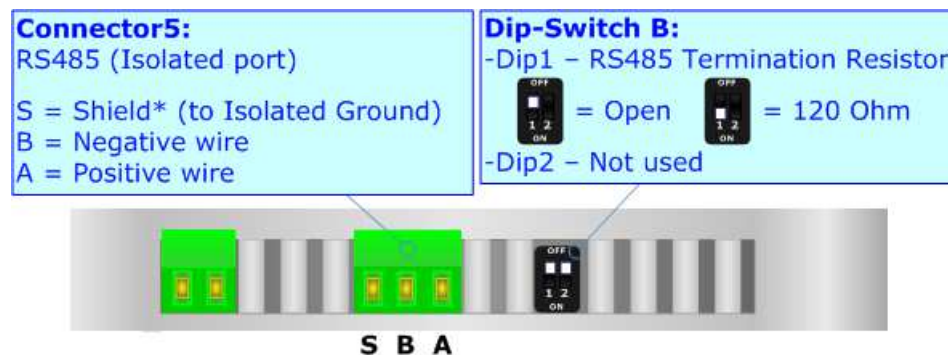

The maximum length of the cable should be 1200m (4000 feet).

Here some codes of cables:

- Belden: p/n 8132 - 2x 28AWG stranded twisted pairs conductor + foil shield + braid shield;
- Belden p/n 82842 - 2x 24AWG stranded twisted pairs conductor + foil shield + braid shield;
- Tasker: p/n C521 - 1x 24AWG twisted pair conductor + foil shield + braid shield;
- Tasker: p/n C522 - 2x 24AWG twisted pairs conductor + foil shield + braid shield.

## USE OF COMPOSITOR SW67603:

To configure the Converter, use the available software that runs with Windows called SW67603. It is downloadable on the site [www.adfweb.com](http://www.adfweb.com) and its operation is described in this document. (*This manual is referenced to the last version of the software present on our web site*). The software works with MSWindows (XP, Vista, Seven, 8, 10; 32/64bit).

When launching the SW67603, the window below appears (Fig. 2).



### Note:

It is necessary to have installed .Net Framework 4.

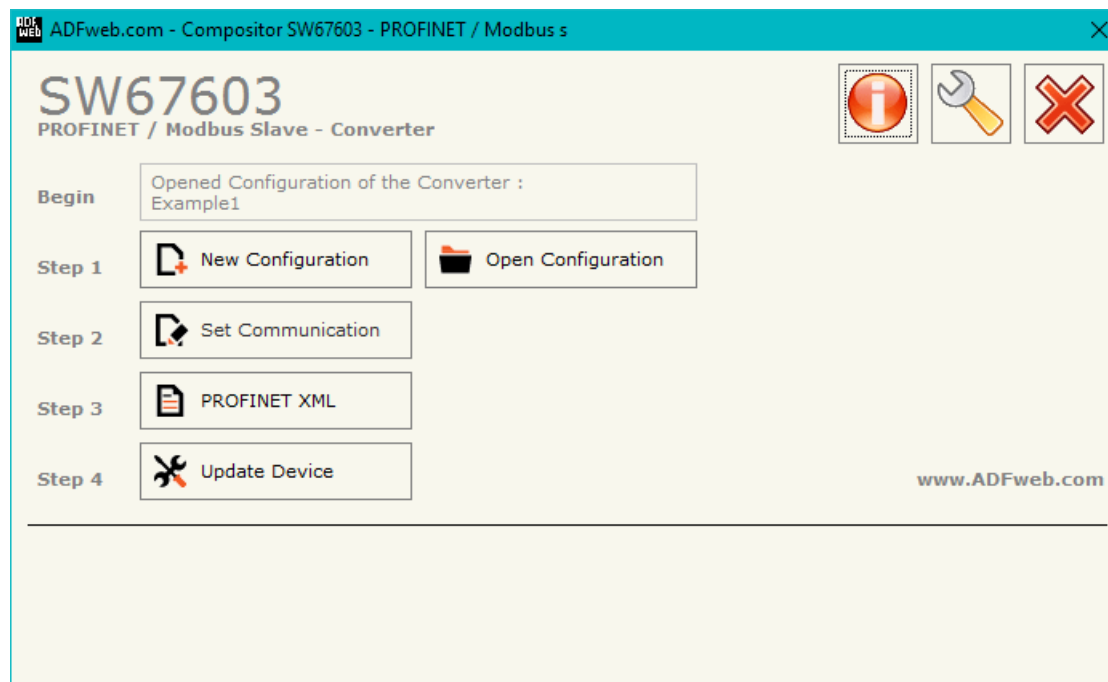
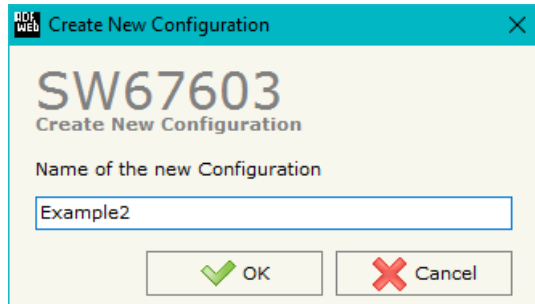

Figure 2: Main window for SW67603

**NEW CONFIGURATION / OPEN CONFIGURATION:**

The “**New Configuration**” button creates the folder which contains the entire device’s configuration.



A device’s configuration can also be imported or exported:

- To clone the configurations of a Programmable “PROFINET / Modbus Slave - Converter” in order to configure another device in the same manner, it is necessary to maintain the folder and all its contents;
- To clone a project in order to obtain a different version of the project, it is sufficient to duplicate the project folder with another name and open the new folder with the button “**Open Configuration**”.

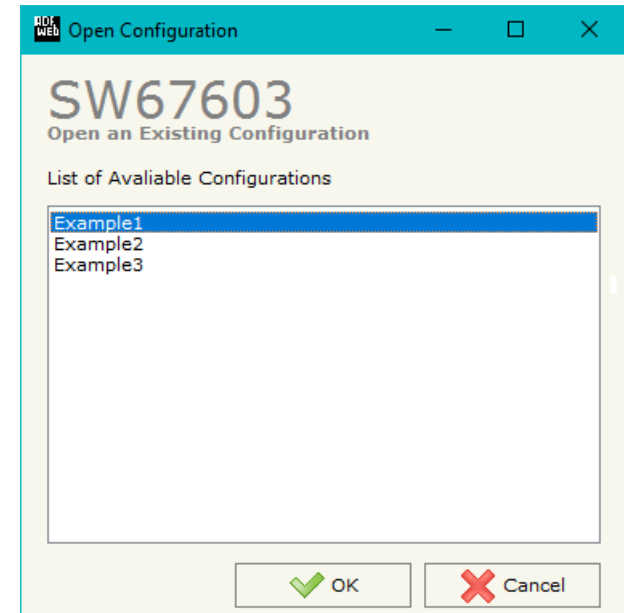

## SOFTWARE OPTIONS:

By pressing the “**Settings**” () button there is the possibility to change the language of the software and check the updatings for the compositor.

In the section “Language” it is possible to change the language of the software.

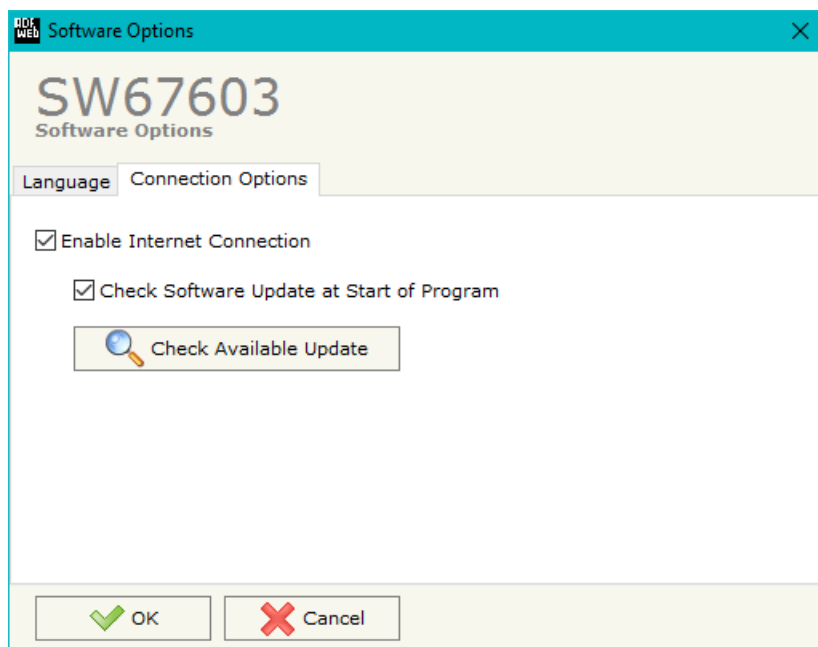

In the section “Connection Options”, it is possible to check if there are some updatings of the software compositor in ADFweb.com website. Checking the option “**Check Software Update at Start of Program**”, the SW67603 check automatically if there are updatings when it is launched.

## SET COMMUNICATION:

This section define the fundamental communication parameters of two buses, PROFINET and Modbus.

By Pressing the **"Set Communication"** button from the main window for SW67603 (Fig. 2) the window "Set Communication" appears (Fig. 3).

The window is divided in two sections, one for the PROFINET and the other for the Modbus Slave.

The means of the fields for "PROFINET" are:

- In the field **"IP ADDRESS"** the IP address of the converter is defined;
- In the field **"SUBNET Mask"** the SubNet Mask of the converter is defined;
- In the field **"GATEWAY"** the default gateway of the network is defined. This feature can be enabled or disabled pressing the Check Box field. This feature is used for going out of the net;
- In the field **"Port"** the port used for PROFINET communication is defined. The port has a fixed value of '34964';
- In the field **"PROFINET Name of Station"** the name to the PROFINET side of the converter is defined;
- In the fields **"PROFINET -> Gateway"** the number of input byte of the slave station is defined;
- In the fields **"PROFINET <- Gateway"** the number of output byte of the slave station is defined.

The means of the fields for the "Modbus Slave" section are:

- In the field **"Serial"** the serial port to use is defined (RS232 or RS485);
- In the field **"Baudrate"** the baudrate for the serial line is defined;
- In the field **"Parity"** the parity of the serial line is defined;
- In the field **"Device ID"** the ID of Modbus side is defined;
- If the field **"Read with Input Register / Status Function"** is checked, it is possible to read the Input bytes of PROFINET side with Input Registers (Function 04) and write the Output bytes of PROFINET side with Holding Registers (Function 06/16). The Output bytes are readable with Function 03. Otherwise, only Holding Registers will be used and the Output bytes of PROFINET side cannot be read back.

The screenshot shows the 'Set Communication' window for device SW67603. The window is titled 'Set Communication' and 'SW67603 Set Communication Setting'. It is divided into two main sections: 'PROFINET' and 'Modbus Slave'. The 'PROFINET' section includes fields for IP ADDRESS (192.168.0.10), SUBNET Mask (255.255.255.0), a checkbox for GATEWAY, Port (34964), PROFINET Name of Station (devicename1), PROFINET -> Gateway (512), and PROFINET <- Gateway (512). The 'Modbus Slave' section includes fields for Serial (RS485), Baudrate (115200), Parity (NONE), ID Device (10), and a checkbox for Read with Input Register / Status Function. At the bottom, there are 'OK' and 'Cancel' buttons.

Figure 3: "Set Communication" window



## UPDATE DEVICE:

By pressing the **“Update Device”** button it is possible to load the created Configuration into the device; and also the Firmware, if is necessary.

If you don't know the actual IP address of the device you have to use this procedure:

- Turn OFF the Device;
- Put Dip2 of 'Dip-Switch A' at ON position;
- Turn ON the device
- Connect the Ethernet cable;
- Insert the IP **“192.168.2.205”**;
- Press the **“Ping”** button, must appear **“Device Found!”**;
- Press the **“Next”** button;
- Select which operations you want to do;
- Press the **“Execute update firmware”** button to start the upload;
- When all the operations are **“OK”** turn OFF the Device;
- Put Dip2 of 'Dip-Switch A' at OFF position;
- Turn ON the device.

If you know the actual IP address of the device you have to use this procedure:

- Turn on the Device with the Ethernet cable inserted;
- Insert the actual IP of the Converter;
- Press the **“Ping”** button, must appear **“Device Found!”**;
- Press the **“Next”** button;
- Select which operations you want to do;
- Press the **“Execute update firmware”** button to start the upload;
- When all the operations are **“OK”** the device automatically goes at Normal Mode.

At this point the configuration/firmware on the device is correctly update.

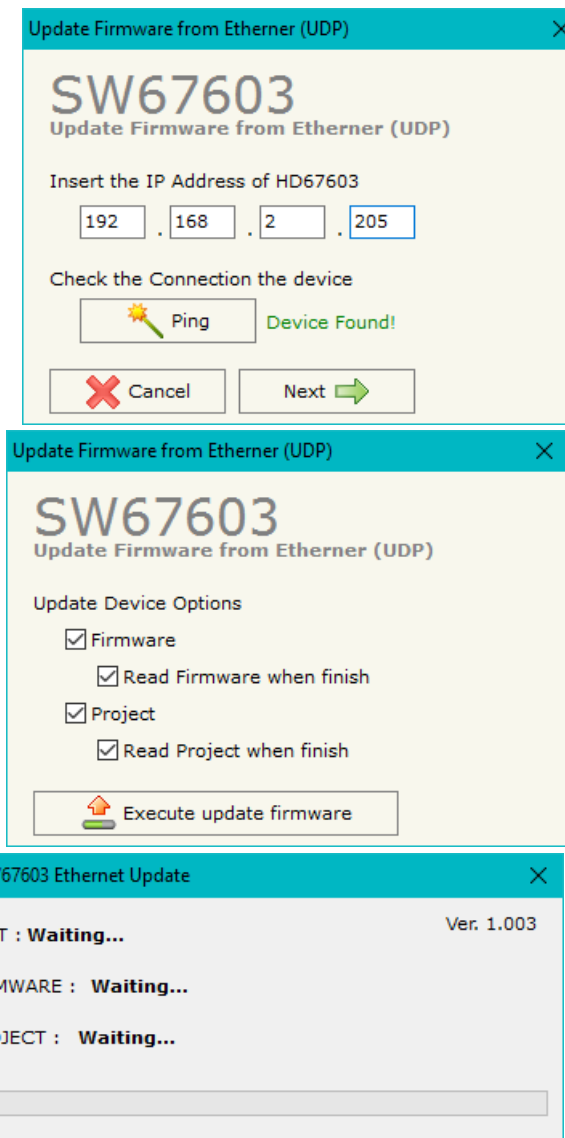





Figure 4: "Update device" windows

 **Note:**  
When you install a new version of the software it is better if the first time you do the update of the Firmware in the HD67603 device.

 **Note:**  
When you receive the device, for the first time, you have to update also the Firmware in the HD67603 device.

 **Warning:**  
If Fig. 5 appears when you try to do the Update try these points before seeking assistance:

- Try to repeat the operations for the updating;
- Try with another PC;
- Try to restart the PC;
- Check the LAN settings;
  
- Check the Wi-Fi settings;
- If you are using the program inside a Virtual Machine, try to use in the main Operating System;
- If you are using Windows Seven, Vista, 8 or 10 make sure that you have the administrator privileges;
- In case you have to program more than one device, using the "UDP Update", you have to cancel the ARP table every time you connect a new device on Ethernet. For do this you have to launch the "Command Prompt" and write the command "arp -d". Pay attention that with Windows Vista, Seven, 8, 10 you have to launch the "Command Prompt" with Administrator Rights;
- Pay attention at Firewall lock.

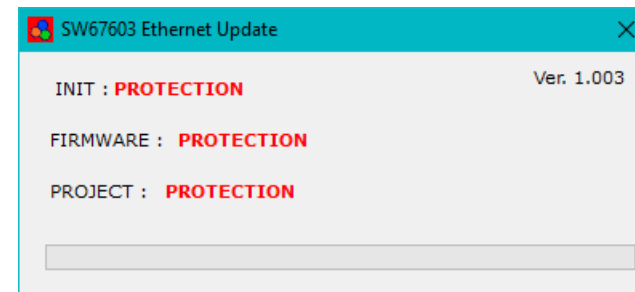



Figure 5: "Protection" window

 In the case of HD67603 you have to use the software "SW67603": [www.adfweb.com/download/filefold/SW67603.zip](http://www.adfweb.com/download/filefold/SW67603.zip).

**MODBUS MAP:**

On Modbus side, the map is created automatically. In relation to the configuration defined, it is possible to have two different maps.

Read with Input Register / Status Function not enabled

Data in reading:

Type	Address	Function	Description
Holding Register	0	03	Input Bytes 0-1 of PROFINET side
Holding Register	1	03	Input Bytes 2-3 of PROFINET side
Holding Register	2	03	Input Bytes 4-5 of PROFINET side
.			
.			
Holding Register	719	03	Input Bytes 1438-1439 of PROFINET side

Data in writing:

Type	Address	Function	Description
Holding Register	0	06/16	Output Bytes 0-1 of PROFINET side
Holding Register	1	06/16	Output Bytes 2-3 of PROFINET side
Holding Register	2	06/16	Output Bytes 4-5 of PROFINET side
.			
.			
Holding Register	719	06/16	Output Bytes 1438-1439 of PROFINET side



Note:

The data can be read/written as single bits too using Coil Status (Function 01 and Functions 05/15).

Read with Input Register / Status Function enabled

Data in reading:

Type	Address	Function	Description
Input Register	0	04	Input Bytes 0-1 of PROFINET side
Input Register	1	04	Input Bytes 2-3 of PROFINET side
Input Register	2	04	Input Bytes 4-5 of PROFINET side
.	.	.	.
Input Register	719	04	Input Bytes 1438-1439 of PROFINET side

Data in writing:

Type	Address	Function	Description
Holding Register	0	R: 03 W: 06/16	Output Bytes 0-1 of PROFINET side
Holding Register	1	R: 03 W: 06/16	Output Bytes 2-3 of PROFINET side
Holding Register	2	R: 03 W: 06/16	Output Bytes 4-5 of PROFINET side
.	.	.	.
Holding Register	719	R: 03 W: 06/16	Output Bytes 1438-1439 of PROFINET side



Note:

The data can be read/written as single bits too using Input/Coil Status (Function 02 and Functions 01/05/15).

**PLC CONFIGURATION:**

The configuration and commissioning of the PROFINET Converter as described on the following pages was accomplished with the help of the TIA Portal V11-software of Siemens. In case of using a control system from another supplier please attend to the associated documentation. These are the steps to follow:

- 1) Install the description file of the module.

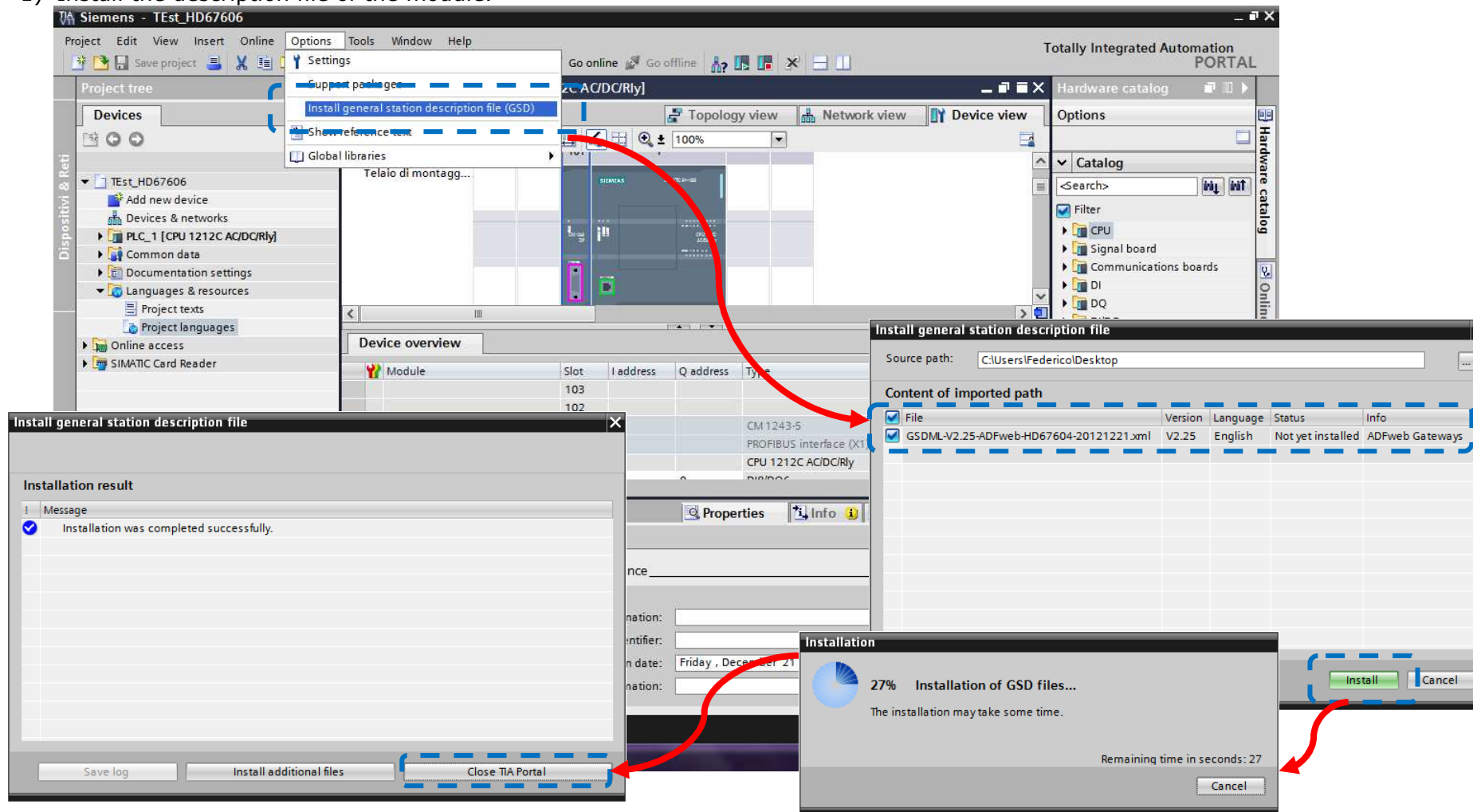

2) Import the module in the network; connect the device to the PLC network and edit the parameters of IP, station name etc.

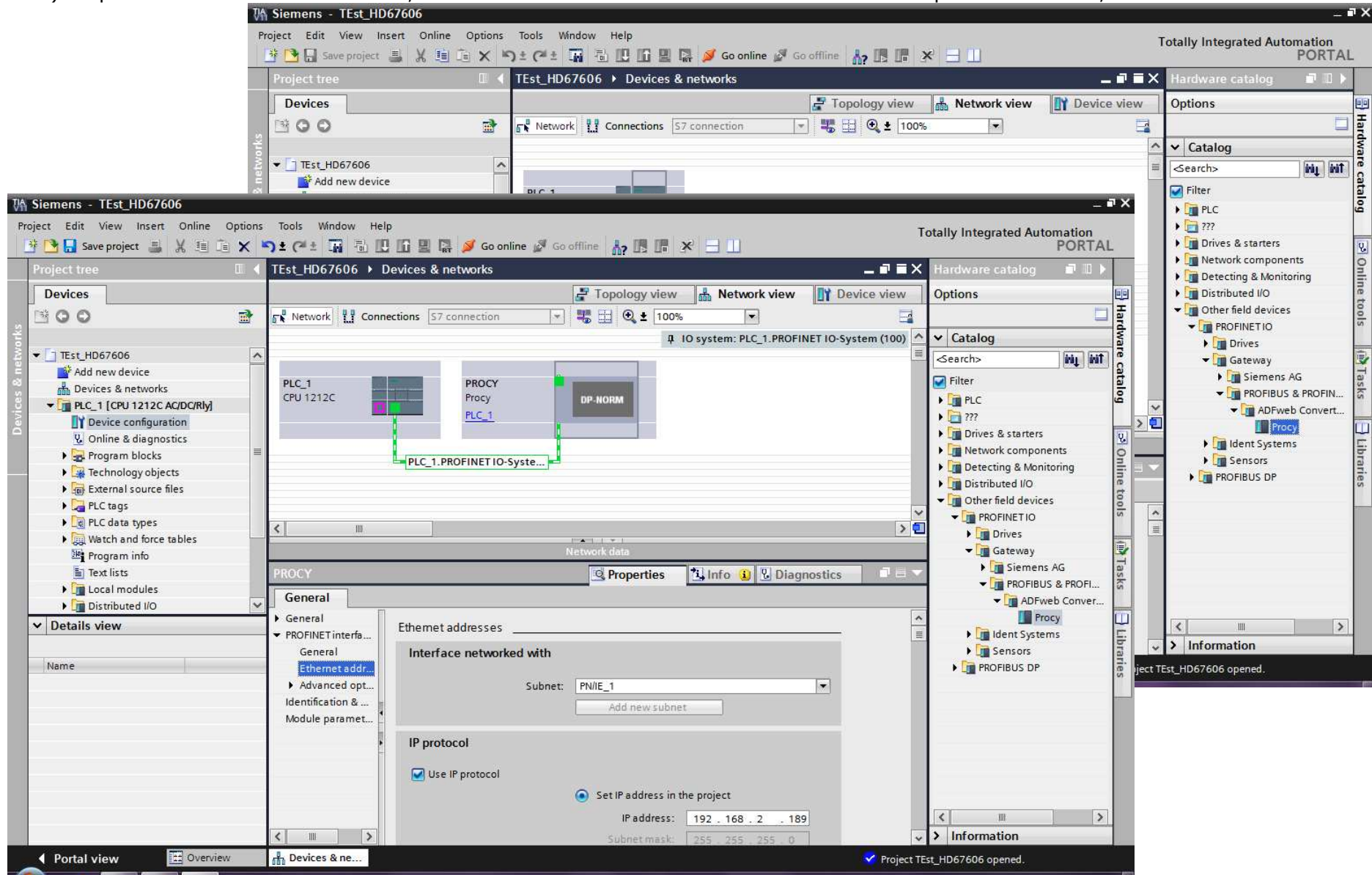

3) Load the configuration into the PLC.

Configured access nodes of "PLC\_1"

Device	Device type	Type	Address	Subnet
PLC_1	CPU 1212C AC/D...	PN/IE	192.168.2.50	PN/IE_1
CM 1243-5	CM 1243-5	PROFIBUS	2	

Type of the PG/PC interface:   
 PG/PC interface:   
 Connection to subnet:   
 1st gateway:

Accessible devices in target subnet:  Show all accessible devices

Device	Device type	Type	Address	Target device
PLC_1	CPU 1212C AC/D...	PN/IE	192.168.2.50	PLC_1
--	--	PN/IE	Access address	--

Flash LED

Online status information:  
 Connected to address 192.168.2.50  
 Scanning ended.

Buttons: Refresh, Load, Cancel

Load preview

Check before loading

Status	!	Target	Message	Action
+	✓	PLC_1	Ready for loading.	
	✓	▶ Stop modules	All modules will be stopped for downloading to device.	Stop all
	✓	▶ Device configurati...	Delete and replace system data in target	Download to device
	✓	▶ Software	Download software to device	Consistent download
	✓	▶ Additional inform...	There are differences between the settings for the project and the se	<input checked="" type="checkbox"/> Overwrite all

Buttons: Refresh, Finish, Load, Cancel

**MECHANICAL DIMENSIONS:**

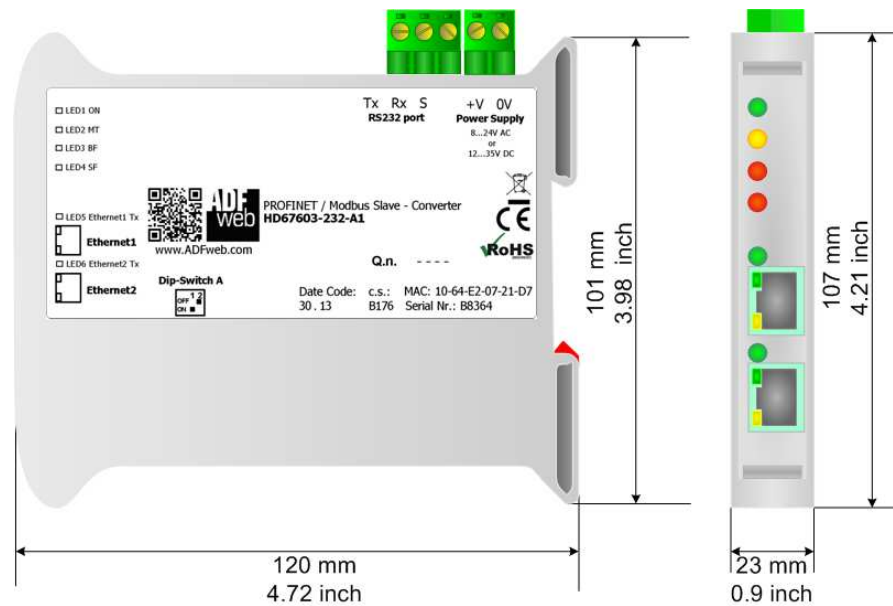

Housing: PVC  
Weight: 200g (Approx)

Figure 6a: Mechanical dimensions scheme for HD67603-232-A1

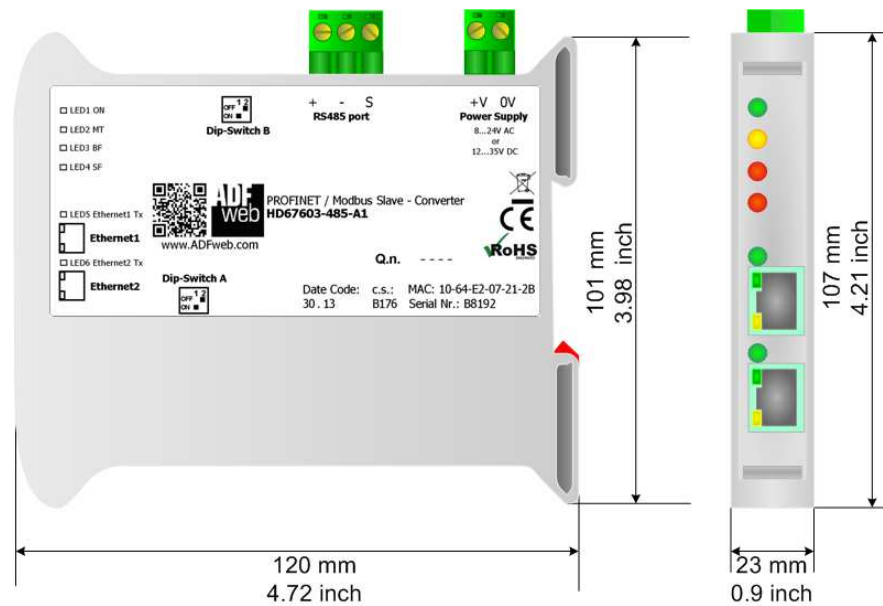

Housing: PVC  
Weight: 200g (Approx)

Figure 6b: Mechanical dimensions scheme for HD67603-485-A1



### ORDERING INFORMATION:

The ordering part number is formed by a valid combination of the following:

**HD67603 - xxx - A 1**

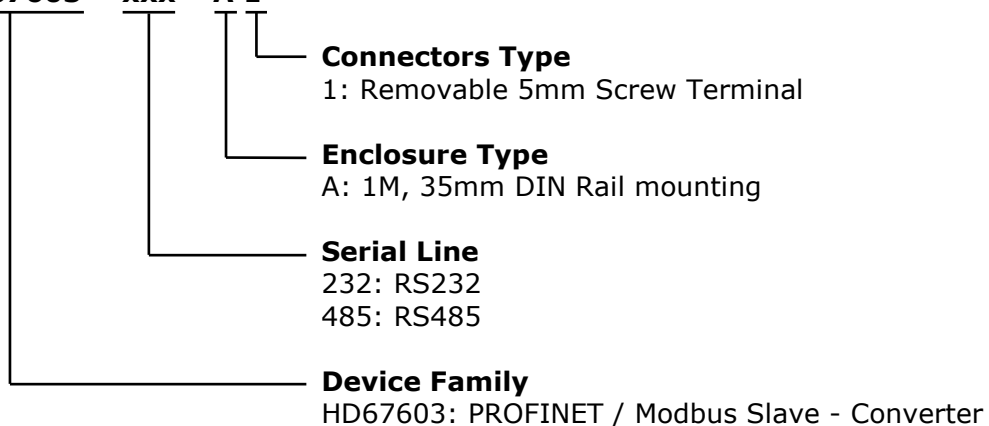

Order Code: **HD670603-232-A1-** Converter PROFINET / Modbus Slave - Converter (RS232 serial)

Order Code: **HD670603-485-A1-** Converter PROFINET / Modbus Slave - Converter (RS485 serial)

### ACCESSORIES:

Order Code: **AC34001** - 35mm Rail DIN - Power Supply 220/240V AC 50/60Hz – 12 V AC

Order Code: **AC34002** - 35mm Rail DIN - Power Supply 110V AC 50/60Hz – 12 V AC

**DISCLAIMER:**

All technical content within this document can be modified without notice. The content of the document is a under continual renewal. For losses due to fire, earthquake, third party access or other accidents, or intentional or accidental abuse, misuse, or use under abnormal conditions repairs are charged to the user. ADFweb.com S.r.l. will not be liable for accidental loss of use or inability to use this product, such as loss of business income. ADFweb.com S.r.l. shall not be liable for consequences of improper use.

**OTHER REGULATIONS AND STANDARDS:****WEEE INFORMATION**

Disposal of old electrical and electronic equipment (as in the European Union and other European countries with separate collection systems).

— This symbol on the product or on its packaging indicates that this product may not be treated as household rubbish. Instead, it should be taken to an applicable collection point for the recycling of electrical and electronic equipment. If the product is disposed correctly, you will help prevent potential negative environmental factors and impact of human health, which could otherwise be caused by inappropriate disposal. The recycling of materials will help to conserve natural resources. For more information about recycling this product, please contact your local city office, your household waste disposal service or the shop where you purchased the product.

**RESTRICTION OF HAZARDOUS SUBSTANCES DIRECTIVE**

The device respects the 2002/95/EC Directive on the restriction of the use of certain hazardous substances in electrical and electronic equipment (commonly referred to as Restriction of Hazardous Substances Directive or RoHS).

**CE MARKING**

The product conforms with the essential requirements of the applicable EC directives.

**WARRANTIES AND TECHNICAL SUPPORT:**

For fast and easy technical support for your ADFweb.com SRL products, consult our internet support at [www.adfweb.com](http://www.adfweb.com). Otherwise contact us at the address [support@adfweb.com](mailto:support@adfweb.com)

**RETURN POLICY:**

If while using your product you have any problem and you wish to exchange or repair it, please do the following:

- Obtain a Product Return Number (PRN) from our internet support at [www.adfweb.com](http://www.adfweb.com). Together with the request, you need to provide detailed information about the problem.
- Send the product to the address provided with the PRN, having prepaid the shipping costs (shipment costs billed to us will not be accepted).

If the product is within the warranty of twelve months, it will be repaired or exchanged and returned within three weeks. If the product is no longer under warranty, you will receive a repair estimate.



**ADFweb.com S.r.l.**  
Via Strada Nuova, 17  
IT-31010 Mareno di Piave  
TREVISO (Italy)  
Phone +39.0438.30.91.31  
Fax +39.0438.49.20.99  
[www.adfweb.com](http://www.adfweb.com)

