

User Manual

Revision 1.100
English

BACnet/IP Slave / Modbus Slave - Converter

(Order Code: HD67672-IP-2-A1, HD67672-IP-4-A1)

BACnet MS/TP Slave / Modbus Slave - Converter

(Order Code: HD67672-MSTP-2-A1, HD67672-MSTP-4-A1)

For Website information:

For Price information:

Benefits and Main Features:

- ⊕ Very easy to configure
- ⊕ Electrical isolation
- ⊕ Temperature range: -40°C/85°C (-40°F/185°F)



User Manual

INDEX:

	Page
INDEX	2
UPDATED DOCUMENTATION	2
REVISION LIST	2
WARNING	2
TRADEMARKS	2
SECURITY ALERT	3
EXAMPLE OF CONNECTION	4
CONNECTION SCHEME	5
CHARACTERISTICS	9
CONFIGURATION	9
POWER SUPPLY	10
FUNCTION MODES	11
LEDS (HD67672-IP-X-A1)	12
LEDS (HD67672-MSTP-X-A1)	13
RS485	14
RS232	15
ETHERNET	15
USE OF COMPOSITOR SW67672	16
NEW PROJECT / OPEN PROJECT	17
SOFTWARE OPTIONS	18
SET COMMUNICATION	20
SET BACNET ACCESS	23
SET BDT ACCESS	25
BACNET EDE FILE	25
UPDATE DEVICE	26
MODBUS MAP	28
MECHANICAL DIMENSIONS	29
ORDERING INFORMATIONS	30
ACCESSORIES	30
DISCLAIMER	31
OTHER REGULATIONS AND STANDARDS	31
WARRANTIES AND TECHNICAL SUPPORT	32
RETURN POLICY	32

UPDATED DOCUMENTATION:

Dear customer, we thank you for your attention and we remind you that you need to check that the following document is:

- Updated
- Related to the product you own

To obtain the most recently updated document, note the “document code” that appears at the top right-hand corner of each page of this document.

With this “Document Code” go to web page www.adfweb.com/download/ and search for the corresponding code on the page. Click on the proper “Document Code” and download the updates.

REVISION LIST:

Revision	Date	Author	Chapter	Description
1.000	15/02/2013	Fl	All	First Release
1.001	01/08/2013	Fl	All	Revision
1.100	21/08/2018	Ff	All	Added MSTP version

WARNING:

ADFweb.com reserves the right to change information in this manual about our product without warning. ADFweb.com is not responsible for any error this manual may contain.

TRADEMARKS:

All trademarks mentioned in this document belong to their respective owners.

SECURITY ALERT:**GENERAL INFORMATION**

To ensure safe operation, the device must be operated according to the instructions in the manual. When using the device, legal and safety regulation are required for each individual application. The same applies also when using accessories.

INTENDED USE

Machines and systems must be designed so the faulty conditions do not lead to a dangerous situation for the operator (i.e. independent limit switches, mechanical interlocks, etc.).

QUALIFIED PERSONNEL

The device can be used only by qualified personnel, strictly in accordance with the specifications.

Qualified personnel are persons who are familiar with the installation, assembly, commissioning and operation of this equipment and who have appropriate qualifications for their job.

RESIDUAL RISKS

The device is state-of-the-art and is safe. The instruments can represent a potential hazard if they are inappropriately installed and operated by untrained personnel. These instructions refer to residual risks with the following symbol:



This symbol indicates that non-observance of the safety instructions is a danger for people that could lead to serious injury or death and / or the possibility of damage.

CE CONFORMITY

The declaration is made by our company. You can send an email to or give us a call if you need it.

EXAMPLE OF CONNECTION:

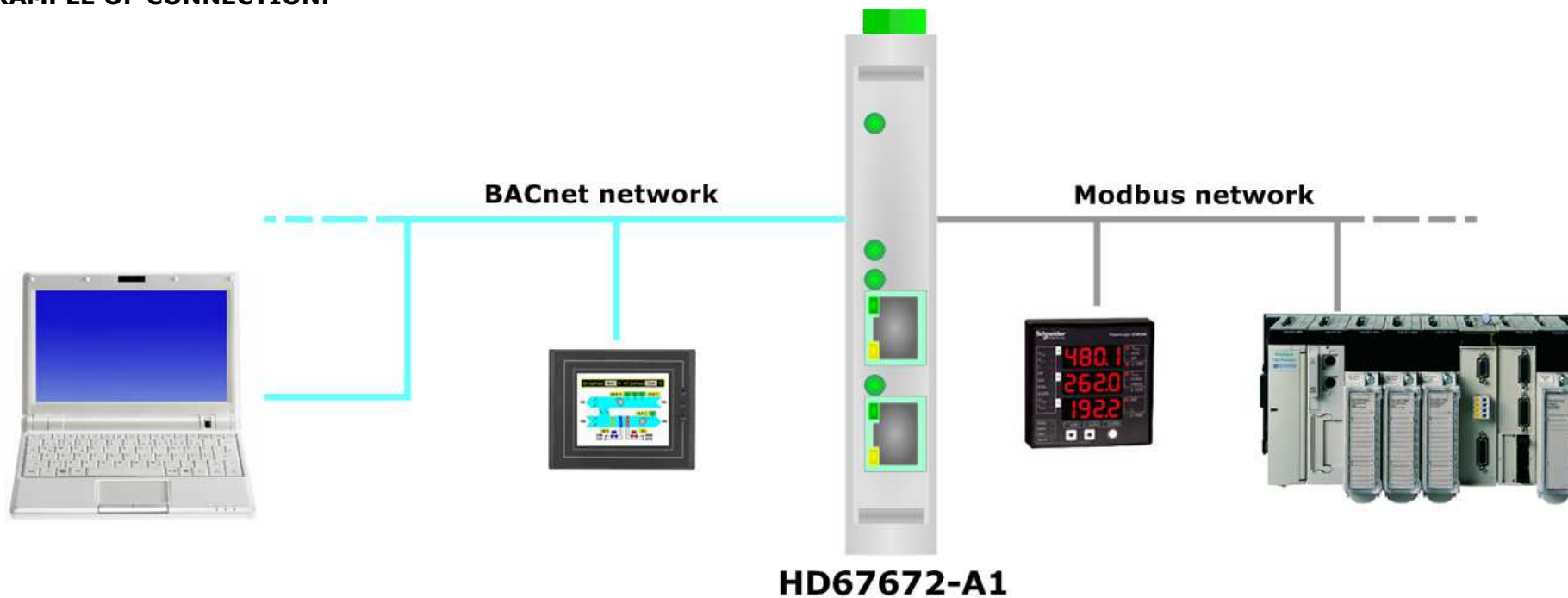

CONNECTION SCHEME:

Dip-Switch A:
 -Dip1 - Must be at ON
 -Dip2 - Functioning Mode
 = Normal = Boot

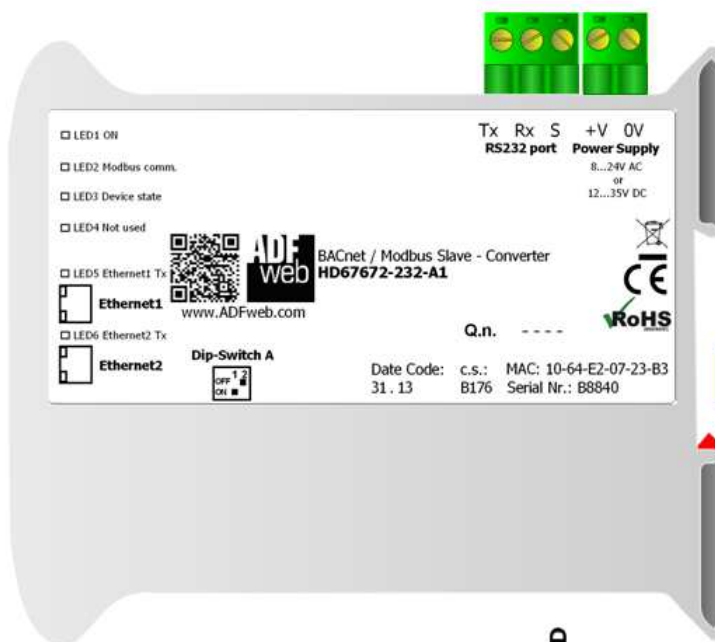

- Led1:** Green ON
- Led2:** Green Modbus comm.
- Led3:** Green Device state
- Led4:** Green Not used
- Led5:** Green Ethernet1 Tx
- Connector3:** Ethernet1 Port (RJ45 Plug)
- Led6:** Green Ethernet2 Tx
- Connector4:** Ethernet2 Port (RJ45 Plug)

Rail DIN Clamp



Connector2:
 RS232 (Isolated port)
 GND = Ground* (to Isolated Ground)
 Rx = Rx line
 Tx = Tx line

Connector1:
 Power Supply port
 0V = Ground
 +V = Positive wire
 V AC: min 8V ; max 24V
 V DC: min 12V ; max 35V

Figure 1a: Connection scheme for HD67672-IP-2-A1

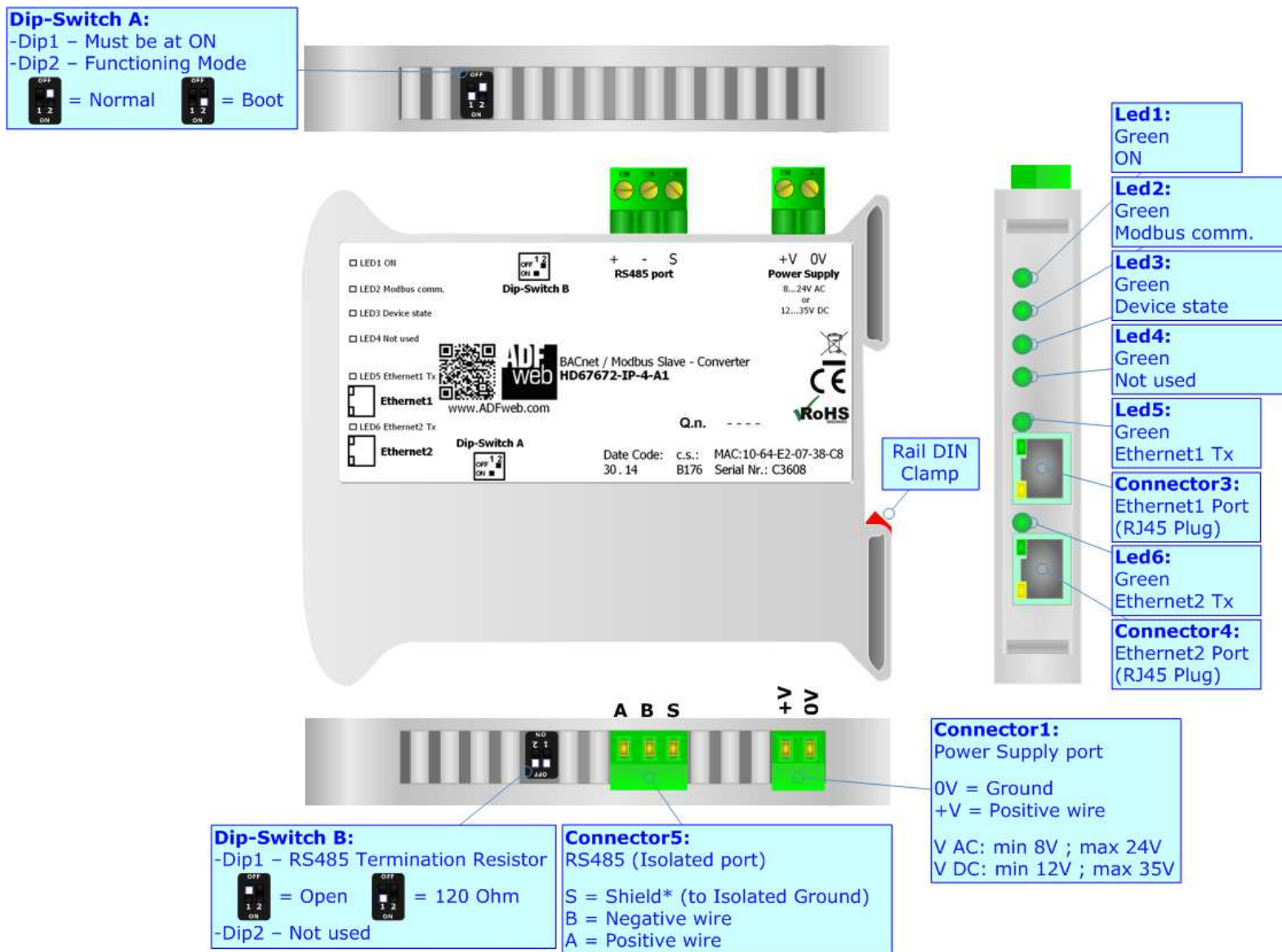

Figure 1b: Connection scheme for HD67672-IP-4-A1

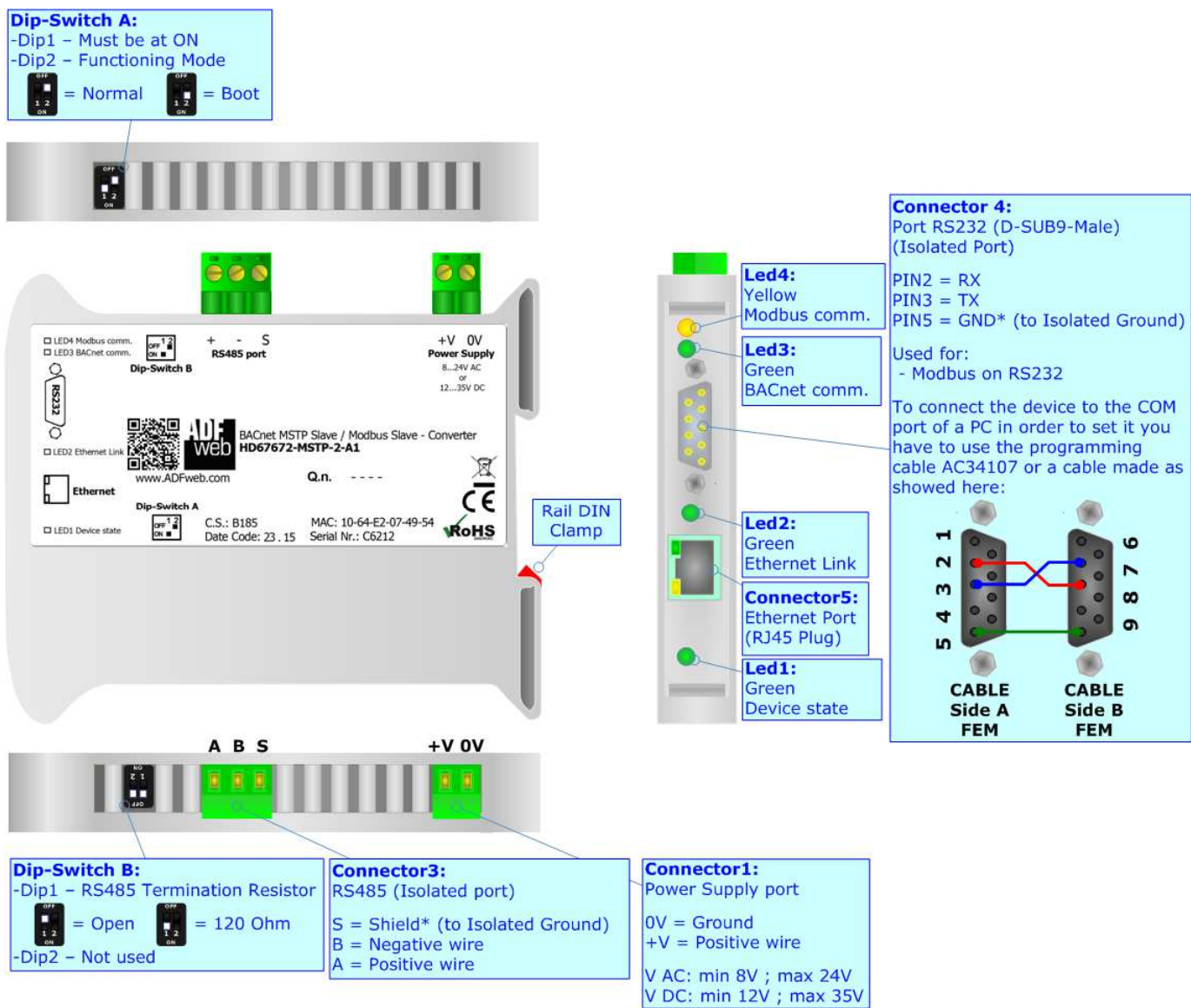

Figure 1c: Connection scheme for HD67672-MSTP-2-A1

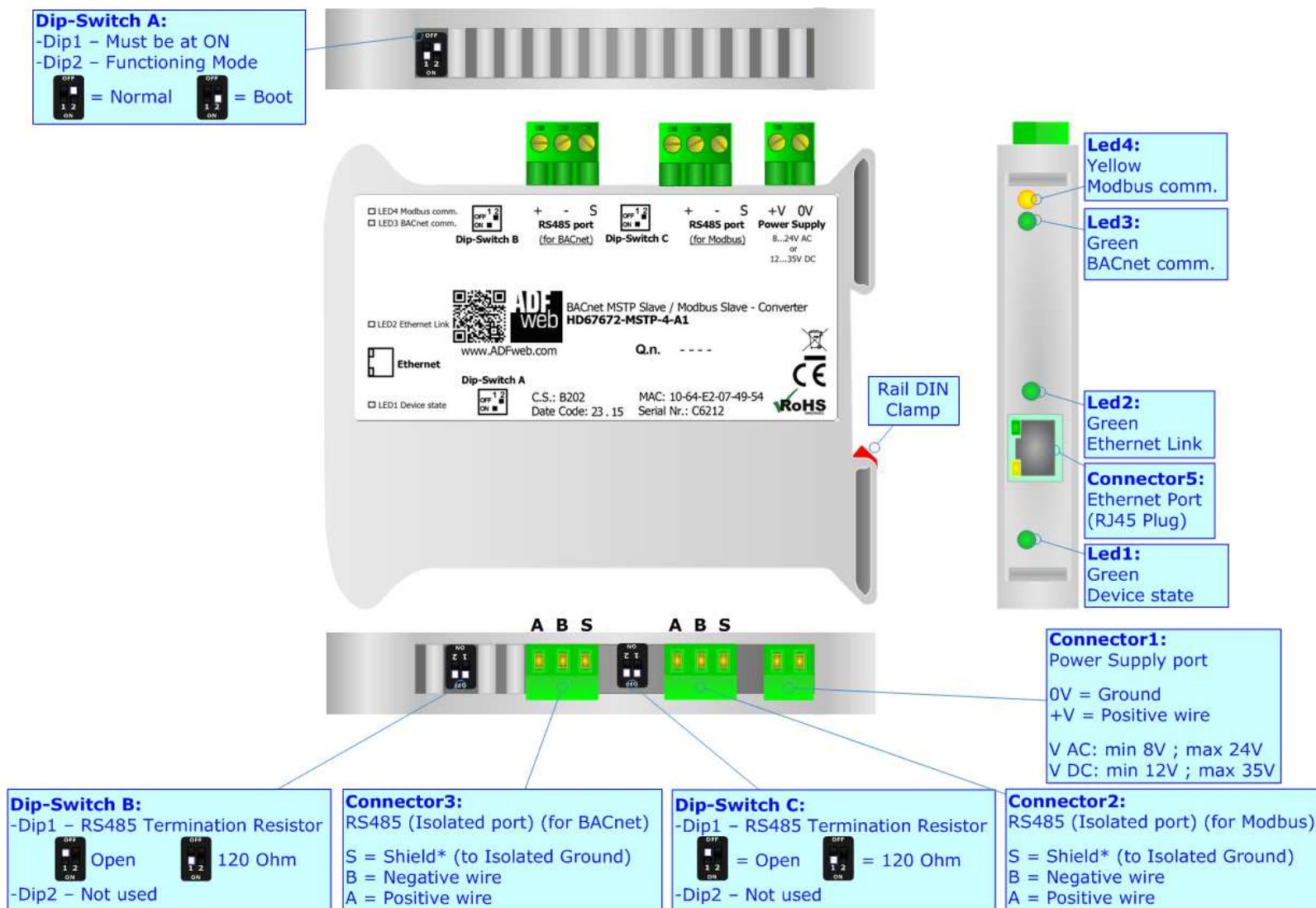

Figure 1d: Connection scheme for HD67672-MSTP-4-A1

CHARACTERISTICS:

The HD67672 is a BACnet / Modbus Slave - Converter.

It has the following characteristics:

- Up to 2000 BACnet objects;
- Triple isolation between BACnet - Power Supply, BACnet - Modbus, Power Supply - Modbus.
- Two-directional information between BACnet bus and Modbus bus;
- Mountable on 35mm Rail DIN;
- Wide power supply input range: 8...24V AC or 12...35V DC;
- Wide temperature range: -40°C / 85°C [-40°F / +185°F].

CONFIGURATION:

You need Compositor SW67672 software on your PC in order to perform the following:

- Define the parameter of BACnet line;
- Define the parameter of Modbus line;
- Define BACnet objects that contains the data sent by the Modbus Master;
- Define BACnet objects that contains the data to send to the Modbus Master;
- Update the device.

POWER SUPPLY:

The devices can be powered at 8...24V AC and 12...35V DC. For more details see the two tables below.

VAC		VDC	
Vmin	Vmax	Vmin	Vmax
8V	24V	12V	35V

Consumption at 24V DC:

Device	Consumption [W/VA]
HD67672-IP-x-A1	3.5
HD67672-MSTP-x-A1	3.5

Connector1:
Power Supply port
0V = Ground
+V = Positive wire
V AC: min 8V ; max 24V
V DC: min 12V ; max 35V

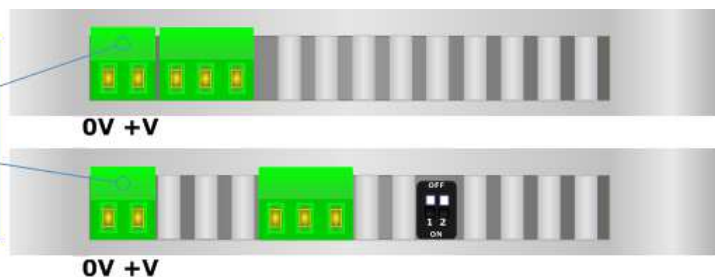

Connector1:
Power Supply port
0V = Ground
+V = Positive wire
V AC: min 8V ; max 24V
V DC: min 12V ; max 35V

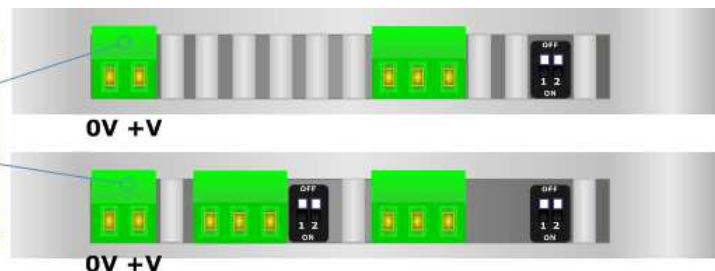

Caution: Not reverse the polarity power

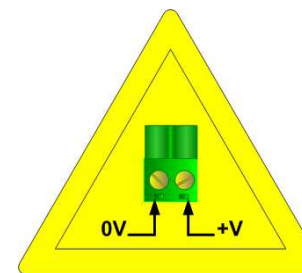

HD67672-IP-x-A1
HD67672-MSTP-x-A1

FUNCTION MODES:

The device has got two functions mode depending of the position of the 'Dip2 of Dip-Switch A':

- The first, with 'Dip2 of Dip-Switch A' at "OFF" position, is used for the normal working of the device.
- The second, with 'Dip2 of Dip-Switch A' at "ON" position, is used for upload the Project and/or Firmware.

For the operations to follow for the updating, see 'UPDATE DEVICE' section.

According to the functioning mode, the LEDs will have specifics functions, see 'LEDS' section.

**Warning:**

Dip1 of 'Dip-Switch A' must be at ON position for working even if the Ethernet cable isn't inserted.

LEDS (HD67672-IP-x-A1):

The device has got six LEDs that are used to give information of the functioning status. The various meanings of the LEDs are described in the table below.

LED	Normal Mode	Boot Mode
1: ON [supply voltage]	ON: Device powered OFF: Device not powered	ON: Device powered OFF: Device not powered
2: Modbus comm.	Blinks when a Modbus request is received	Blinks quickly: Boot state Blinks very slowly (~0.5Hz): update in progress
3: Device state	Blinks slowly (~1Hz)	Blinks quickly: Boot state Blinks very slowly (~0.5Hz): update in progress
4: Not used	OFF	Blinks quickly: Boot state Blinks very slowly (~0.5Hz): update in progress
5: Ethernet1 Tx	Blinks when is transmitting Ethernet frames	Blinks quickly: Boot state Blinks very slowly (~0.5Hz): update in progress
6: Ethernet2 Tx	Blinks when is transmitting Ethernet frames	Blinks quickly: Boot state Blinks very slowly (~0.5Hz): update in progress

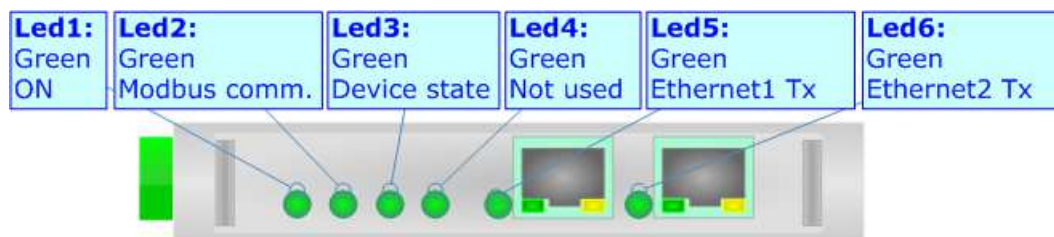

LEDS (HD67672-MSTP-x-A1):

The device has got four LEDs that are used to give information of the functioning status. The various meanings of the LEDs are described in the table below.

LED	Normal Mode	Boot Mode
1: Device state	Blinks slowly (~1Hz)	Blinks quickly: Boot state Blinks very slowly (~0.5Hz): update in progress
2: Ethernet link	ON: Ethernet cable inserted OFF: Ethernet cable not inserted	Blinks quickly: Boot state Blinks very slowly (~0.5Hz): update in progress
3: BACnet comm.	Blinks when BACnet communication is running	Blinks quickly: Boot state Blinks very slowly (~0.5Hz): update in progress
4: Modbus comm.	Blinks when a Modbus request is received	Blinks quickly: Boot state Blinks very slowly (~0.5Hz): update in progress

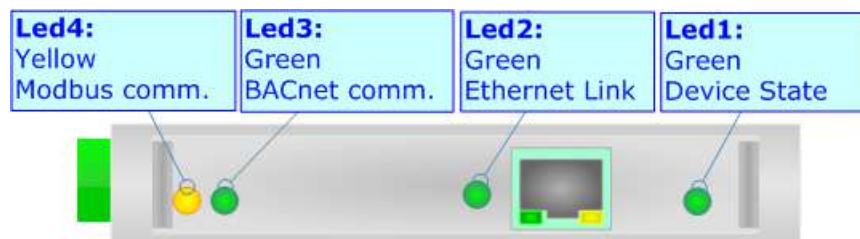

RS485:

For terminate the RS485 line with a 120Ω resistor it is necessary to put ON dip 1, like in figures.

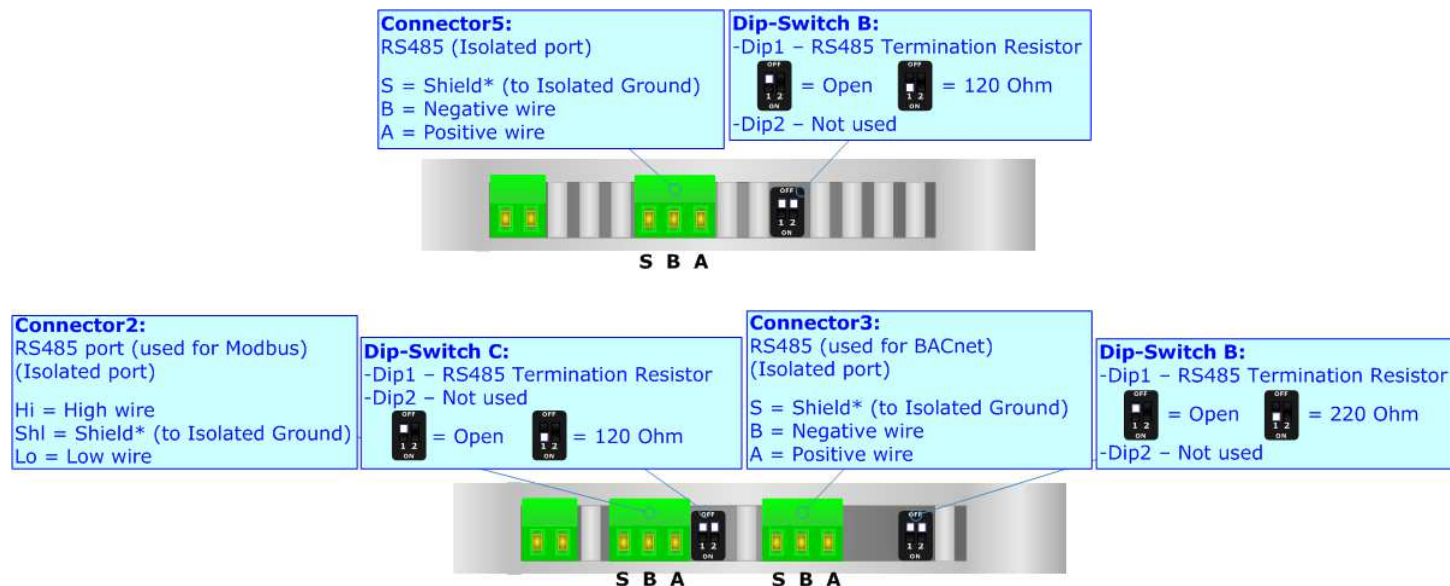

The maximum length of the cable should be 1200m (4000 feet).

Here some codes of cables:

- Belden: p/n 8132 - 2x 28AWG stranded twisted pairs conductor + foil shield + braid shield;
- Belden p/n 82842 - 2x 24AWG stranded twisted pairs conductor + foil shield + braid shield;
- Tasker: p/n C521 - 1x 24AWG twisted pair conductor + foil shield + braid shield;
- Tasker: p/n C522 - 2x 24AWG twisted pairs conductor + foil shield + braid shield.

RS232:

The connection from RS232 socket to a serial port (example one from a personal computer) must be made with a NULL MODEM cable (a serial cable where the pins 2 and 3 are crossed).

It is recommended that the RS232 cable not exceed 15 meters.

ETHERNET:

The BACnet/IP communication and the updating must be made using Connector3 and/or Connector4 and/or Connector5 of HD67672 with at least a Category 5E cable. The maximum length of the cable should not exceed 100m. The cable has to conform to the T568 norms relative to connections in cat.5 up to 100 Mbps. To connect the device to an Hub/Switch is recommended the use of a straight cable, to connect the device to a PC/PLC/other is recommended the use of a cross cable.

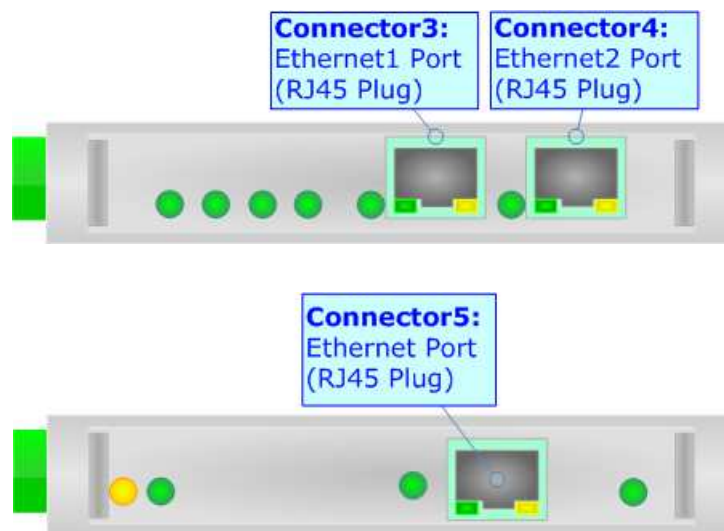

USE OF COMPOSITOR SW67672:

To configure the Converter, use the available software that runs with Windows called SW67672. It is downloadable from the site www.adfweb.com and its operation is described in this document (*this manual is referenced to the last version of the software present on our web site*). The software works with MSWindows (XP, Vista, Seven, 8, 10; 32/64bit).

When launching the SW67672, the window below appears (Fig. 2).



Note:

It is necessary to have installed .Net Framework 4.

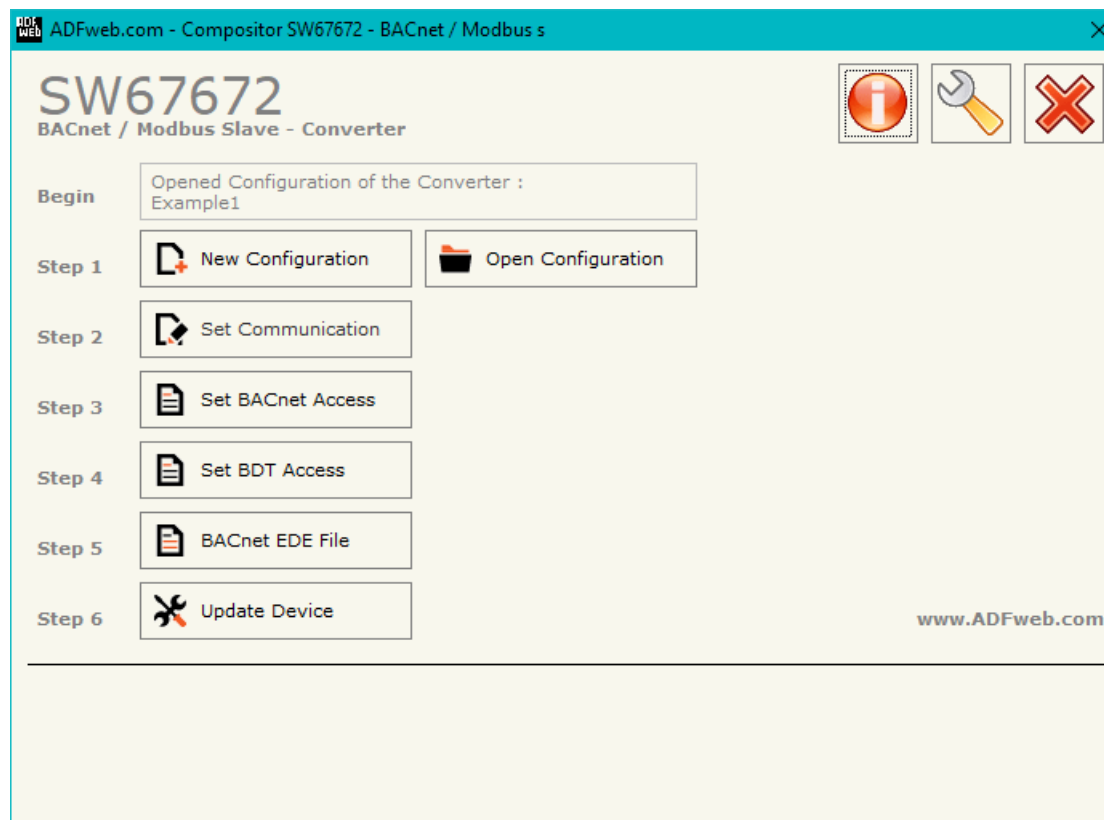
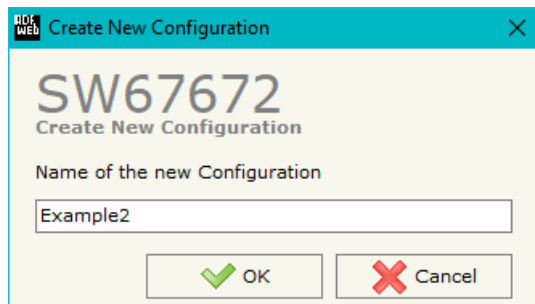

Figure 2: Main window for SW67672

NEW CONFIGURATION / OPEN CONFIGURATION:

The “**New Configuration**” button creates the folder which contains the entire device’s configuration.



A device’s configuration can also be imported or exported:

- To clone the configurations of a Programmable “BACnet Slave / Modbus Slave - Converter” in order to configure another device in the same manner, it is necessary to maintain the folder and all its contents;
- To clone a project in order to obtain a different version of the project, it is sufficient to duplicate the project folder with another name and open the new folder with the button “**Open Configuration**”.

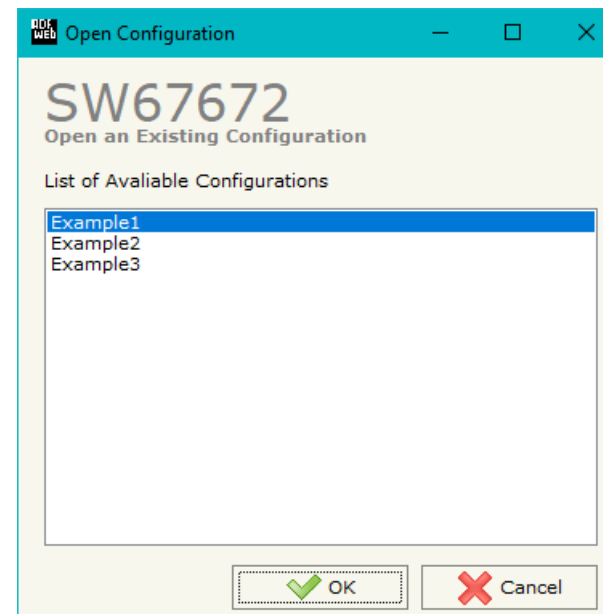

SOFTWARE OPTIONS:

By pressing the “**Settings**” () button there is the possibility to change the language of the software and check the updatings for the compositor.

In the section “Language” it is possible to change the language of the software.

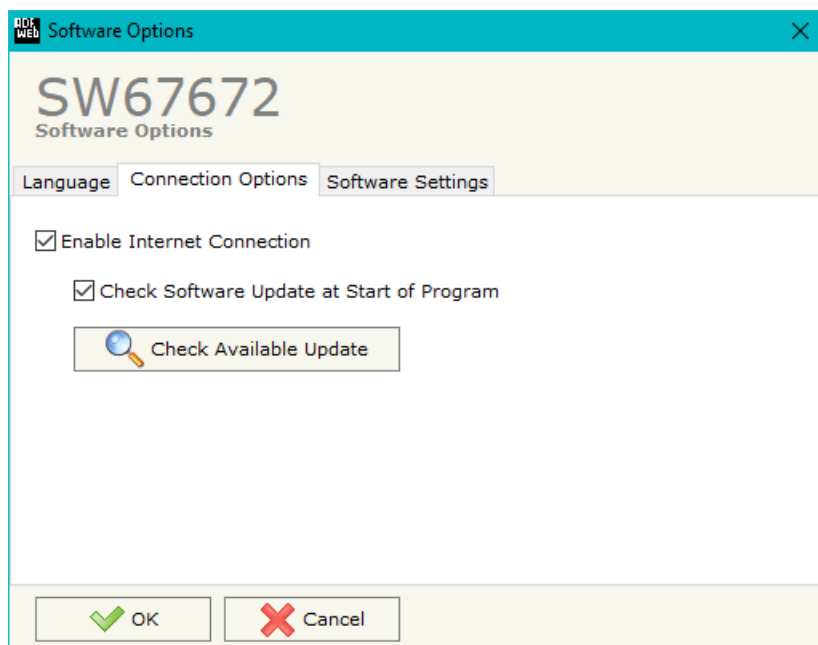

In the section “Connection Options”, it is possible to check if there are some updatings of the software compositor in ADFweb.com website. Checking the option “**Check Software Update at Start of Program**”, the SW67672 check automatically if there are updatings when it is launched.

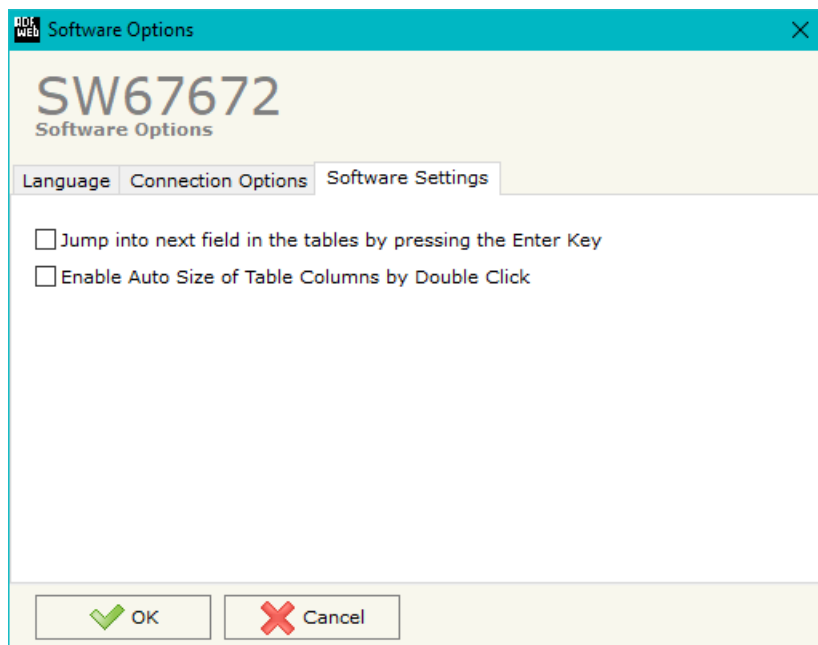

In the section "Software Settings", it is possible to enable/disable some keyboard's commands for an easier navigation inside the tables contained in the different sections of the software.

SET COMMUNICATION:

This section define the fundamental communication parameters of two buses, BACnet and Modbus.

By Pressing the **"Set Communication"** button from the main window for SW67672 (Fig. 2) the window "Set Communication" appears (Fig. 3).

The window is divided in three sections, one for selecting the type of BACnet (in relation to the device used), one for the BACnet parameters and the other for the Modbus parameters.

In the section "BACnet Type" is possible to select the type of BACnet to use from:

- BACnet/IP (uses Ethernet);
- BACnet MS/TP (uses RS485).

If selected "BACnet/IP" the means of the fields for "BACnet" are:

- In the fields **"IP ADDRESS"** the IP address of BACnet/IP side of the converter is defined;
- In the fields **"SUBNET Mask"** the SubNet Mask of BACnet/IP side of the converter is defined;
- In the fields **"GATEWAY"** the default gateway of the network is defined. This feature can be enabled or disabled pressing the Check Box field. This feature is used for going out of the net;
- In the field **"Port"** the port used for BACnet communication is defined. The default port used for BACnet communication is 47808, but is possible to insert any value (except 10000 and 10001);
- In the field **"BACnet Device Name"** the name of BACnet/IP side of the converter is defined;
- In the field **"Device Identifier"** the ID of BACnet/IP side of the converter is defined;
- If the field **"BACnet description up to 32 chars"** is checked, the description for the BACnet Objects can be up to 32 chars long;
- If the field **"Enable BBMD"** is checked, the BACnet/IP Broadcast Management Device function is enabled;
- If the field **"Accept FDR"** is checked, the converter accepts the Foreign Device Registration.

The screenshot shows the "Set Communication" window for device SW67672. The window is titled "Set Communication" and "SW67672 Set Communication Setting". It is divided into three main sections: "BACnet Type", "BACnet", and "Modbus Slave".

- BACnet Type:** A dropdown menu is set to "BACnet/IP".
- BACnet:** This section contains several fields and checkboxes:
 - IP ADDRESS:** 192, 168, 0, 10
 - SUBNET Mask:** 255, 255, 255, 0
 - GATEWAY:** A checkbox is unchecked, and the field contains 192, 168, 0, 1.
 - Port:** 47808
 - BACnet Device Name:** bacnetadfweb
 - Device Identifier:** 12345
 - Checkboxes for "BACnet description up to 32 chars", "Enable BBMD", and "Accept FDR" are all unchecked.
- Modbus Slave:** This section contains several fields and dropdown menus:
 - Serial:** RS232
 - Baudrate:** 115200
 - Parity:** NONE
 - ID Device:** 10

At the bottom of the window are two buttons: "OK" (with a green checkmark) and "Cancel" (with a red X).

Figure 3: "Set Communication" window

The means of the fields for the "Modbus Slave" section are:

- In the field "**Serial**" the serial port used for the Modbus communication is defined;
- In the field "**Baudrate**" the data rate of the Modbus line is defined;
- In the field "**Parity**" the parity of the Modbus line is defined;
- In the field "**Stop Bits**" the number of Stop-bit of the Modbus line is defined;
- In the field "**ID Device**" the ID of Modbus side of the converter is defined.

If selected "BACnet MS/TP", the means of the fields for "BACnet" are:

- In the field "**Baudrate**" the data rate of the BACnet line is defined;
- In the field "**Parity**" the parity of the line is defined;
- In the field "**BACnet Device Name**" the name to give to the BACnet node is defined;
- In the field "**MAC Address**" the MAC of BACnet node (from 0 to 254) is defined;
- The field "**Max Master**" specifies the highest allowable address for master nodes. The value shall be less than or equal to 127;
- The field "**Max Info Frames**" specifies the maximum number of information frames the node may send before it must pass the token;
- In the field "**Device Instance**" the of the BACnet MS/TP side of the converter is defined;
- In the field "**Network**" the BACnet MS/TP network number is defined;
- If the field "**BACnet description up to 32 chars**" is checked, the description for the BACnet Objects can be up to 32 chars long.

The means of the fields for the "Ethernet Update" section are:

- In the fields "**IP ADDRESS**" the IP address of the converter is defined;
- In the fields "**SUBNET Mask**" the SubNet Mask of the converter is defined;
- In the fields "**GATEWAY**" the default gateway of the network is defined. This feature can be enabled or disabled pressing the Check Box field. This feature is used for going out of the net.

These information are used for programming the converter.

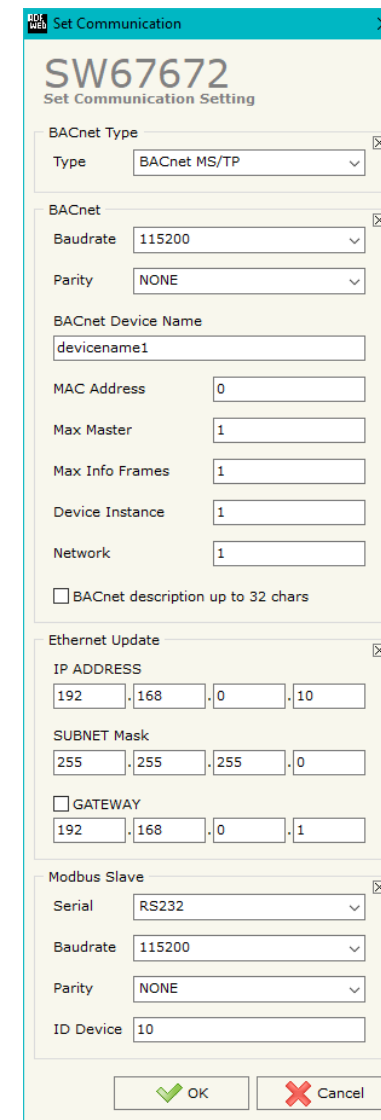

SET BACNET ACCESS:

By Pressing the “**Set BACnet Access**” button from the main window for SW67672 (Fig. 2) the window “Set Communication” appears (Fig. 4).

The window is divided in two parts, the “**BACnet in Read**” that contains the BACnet objects readable by a BACnet Master (the Modbus registers associated to these objects are writeable by a Modbus master); and “**BACnet in Write**” that contains the BACnet objects writeable by a BACnet Master (the Modbus registers associated to these objects are readable by a Modbus Master).

The meaning of the fields in the window are the follows:

- In the field “**Data Type**” it is possible to select the BACnet object data type;
- In the field “**Eng. Unit**”, with double click the window “*Select the BACnet Engineering Unit*” appears (Fig. 5);
- In the field “**Position**” it is possible to select the position where take/save the data from a 1400 bytes array;
- The field “**Start Bit**” is used for the “Binary In” and “Binary Out” BACnet objects;
- The field “**Length**” is used for all the others BACnet objects.

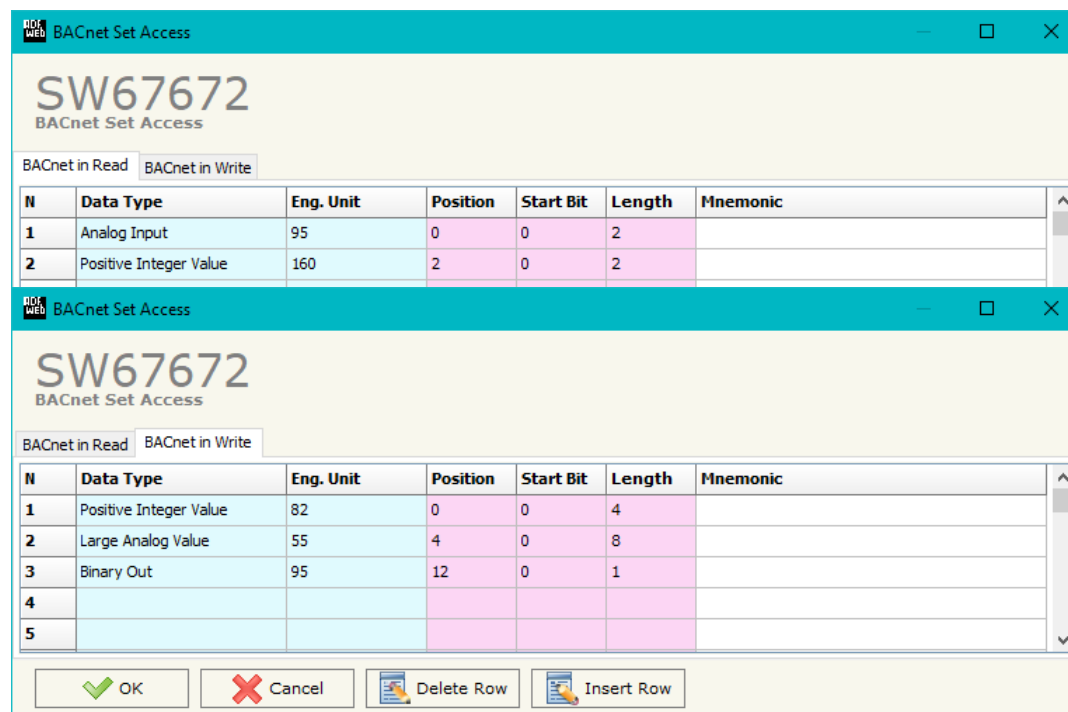

Figure 4: “BACnet Set Access” window

Is possible to insert directly the Unit (using its unique number) by compiling the **"Selected BACnet Engineering Unit"** field; or by selecting with the fields **"Select the Type"** and **"Select unit"** the Type/Unit desired. If the second way is used, is necessary to press the **"Select Engineering Unit"** button for confirm the choice.

ADFweb Select the BACnet Engineering Unit

SW67672
Select the BACnet Engineering Unit

Selected BACnet Engineering Unit -> no-units

Select a New BACnet Engineering Unit

Select the Type

Select Unit

Figure 5: "Select the BACnet Engineering Unit" window

SET BDT ACCESS:

By Pressing the **“Set BDT Access”** button from the main window for SW67672 (Fig. 2) the window **“Broadcast Distribution Table Access”** appears (Fig. 6).

This table is used to readdress the broadcast messages to specific IP Addresses in the network.

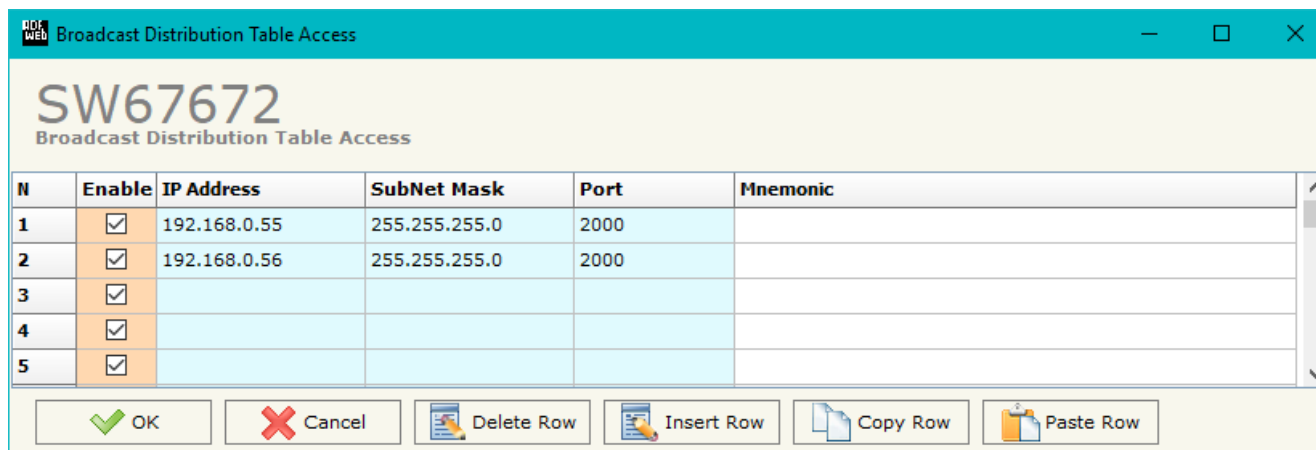

Figure 6: **“BACnet Set Access”** window

The meaning of the fields in the window are the follows:

- If the field **“Enable”** is checked, the BDT rule is enabled;
- In the field **“IP Address”** the IP Address to which address the broadcast message is defined;
- In the field **“SubNet Mask”** the SubNet Mask to use is defined;
- In the field **“Port”** the port to use is defined;
- In the field **“Mnemonic”** a brief description is define.

BACNET EDE FILE:

By pressing the **“BACnet EDE File”** button from the main window for SW67672 (Fig. 2) it is possible to create the EDE file to be imported inside the BACnet Master.

UPDATE DEVICE:

By pressing the **"Update Device"** button it is possible to load the created Configuration into the device; and also the Firmware, if is necessary.

If you don't know the actual IP address of the device you have to use this procedure:

- Turn OFF the Device;
- Put Dip2 of 'Dip-Switch A' at ON position;
- Turn ON the device
- Connect the Ethernet cable;
- Insert the IP **"192.168.2.205"**;
- Press the **"Ping"** button, must appear **"Device Found!"**;
- Press the **"Next"** button;
- Select which operations you want to do;
- Press the **"Execute update firmware"** button to start the upload;
- When all the operations are **"OK"** turn OFF the Device;
- Put Dip2 of 'Dip-Switch A' at OFF position;
- Turn ON the device.

If you know the actual IP address of the device you have to use this procedure:

- Turn ON the Device with the Ethernet cable inserted;
- Insert the actual IP of the Converter;
- Press the **"Ping"** button, must appear **"Device Found!"**;
- Press the **"Next"** button;
- Select which operations you want to do;
- Press the **"Execute update firmware"** button to start the upload;
- When all the operations are **"OK"** the device automatically goes at Normal Mode.

At this point the configuration/firmware on the device is correctly update.

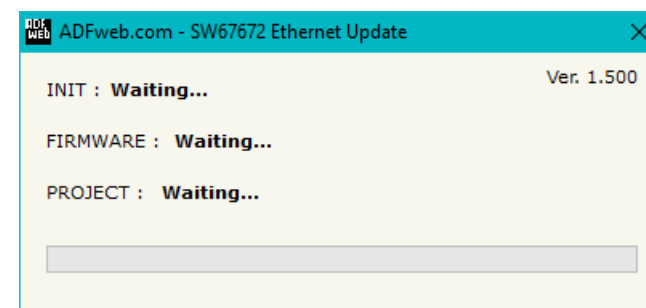
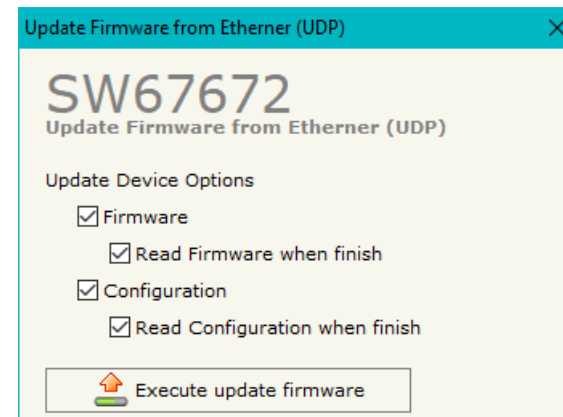
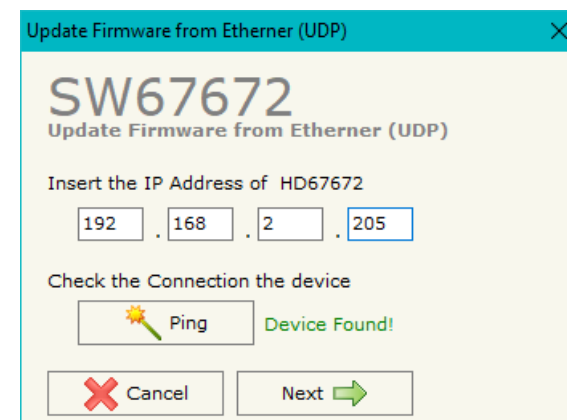





Figure 7: "Update device" windows

 **Note:**
When you install a new version of the software, if it is the first time it is better you do the update of the Firmware in the HD67672 device.

 **Note:**
When you receive the device, for the first time, you also have to update the Firmware in the HD67672 device.

 **Warning:**
If Fig. 8 appears when you try to do the Update try these points before seeking assistance:

- Try to repeat the operations for the updating;
- Try with another PC;
- Try to restart the PC;
- Check the LAN settings;
- Check the Wi-Fi settings;
- If you are using the program inside a Virtual Machine, try to use in the main Operating System;
- If you are using Windows Seven, Vista, 8 or 10 make sure that you have the administrator privileges;
- In case you have to program more than one device, using the "UDP Update", you have to cancel the ARP table every time you connect a new device on Ethernet. For do this you have to launch the "Command Prompt" and write the command "arp - d". Pay attention that with Windows Vista, Seven, 8, 10 you have to launch the "Command Prompt" with Administrator Rights;
- Pay attention at Firewall lock.

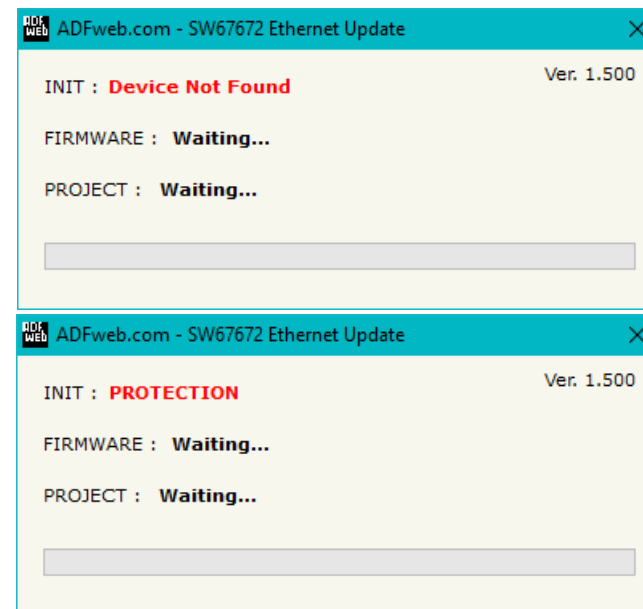



Figure 8: Error windows

 In the case of HD67672 you have to use the software "SW67672": www.adfweb.com/download/filefold/SW67672.zip.

MODBUS MAP:

On Modbus side, the map is created automatically. In relation to the configuration defined, it is possible to have two different maps.

Data in reading:

Type	Address	Function	Description
Input Register	0	03	Bytes (Positions) 0-1 of internal array
Input Register	1	03	Bytes (Positions) 2-3 of internal array
Input Register	2	03	Bytes (Positions) 4-5 of internal array
.			
.			
Input Register	719	03	Bytes (Positions) 1438-1439 of internal array

Data in writing:

Type	Address	Function	Description
Holding Register	0	06/16	Bytes (Positions) 0-1 of internal array
Holding Register	1	06/16	Bytes (Positions) 2-3 of internal array
Holding Register	2	06/16	Bytes (Positions) 4-5 of internal array
.			
.			
Holding Register	719	06/16	Bytes (Positions) 1438-1439 of internal array



Note:

The data can be read/written as single bits too using Coil Status (Function 01 and Functions 05/15).
The data written cannot be read back.

MECHANICAL DIMENSIONS:

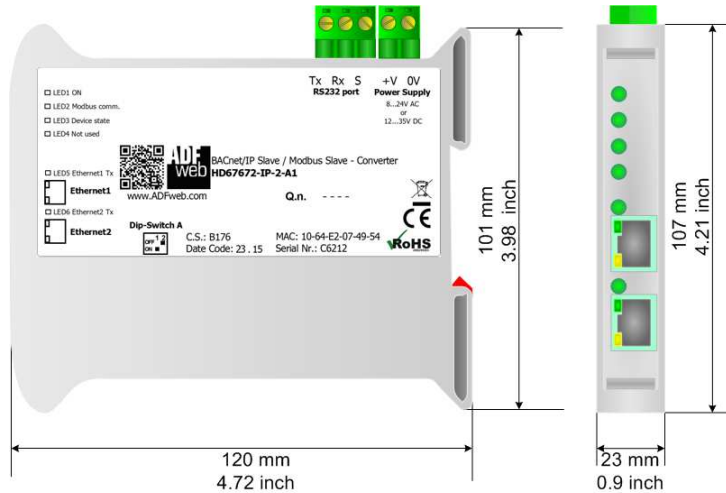

Housing: PVC
Weight: 200g (Approx)

Figure 9a: Mechanical dimensions scheme for HD67672-IP-2-A1

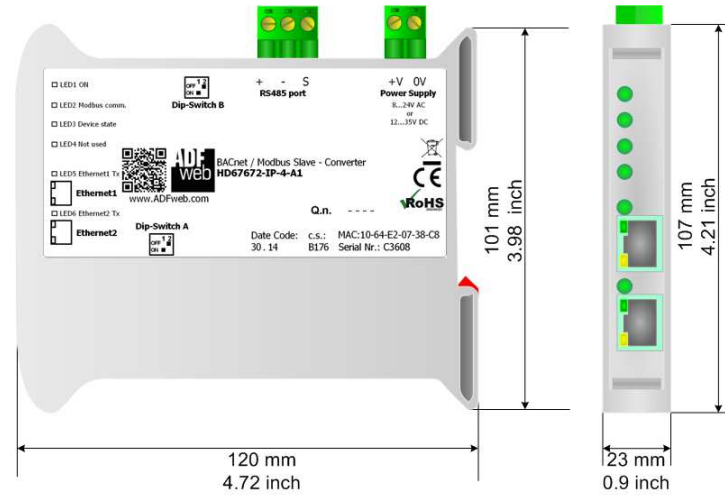

Housing: PVC
Weight: 200g (Approx)

Figure 9b: Mechanical dimensions scheme for HD67672-IP-4-A1

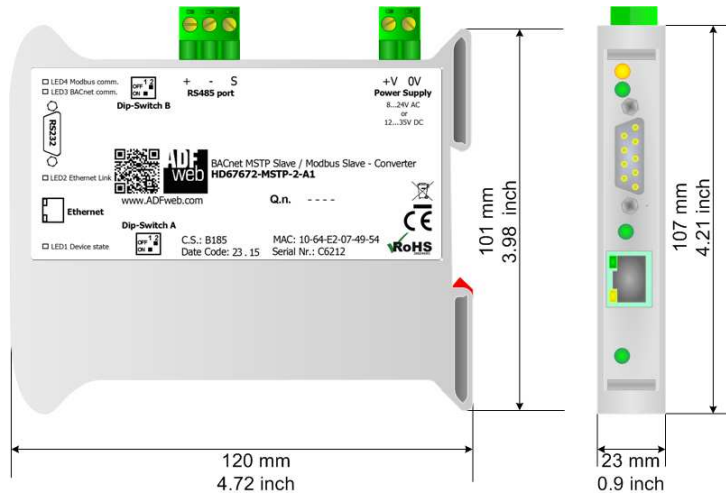

Housing: PVC
Weight: 200g (Approx)

Figure 9c: Mechanical dimensions scheme for HD67672-MSTP-2-A1

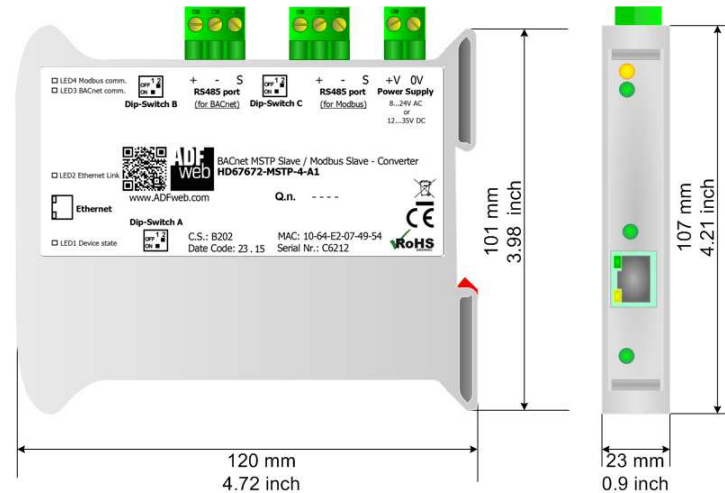

Housing: PVC
Weight: 200g (Approx)

Figure 9d: Mechanical dimensions scheme for HD67672-MSTP-4-A1

ORDERING INFORMATIONS:

The ordering part number is formed by a valid combination of the following:

HD67672 - IP - 2 - A 1

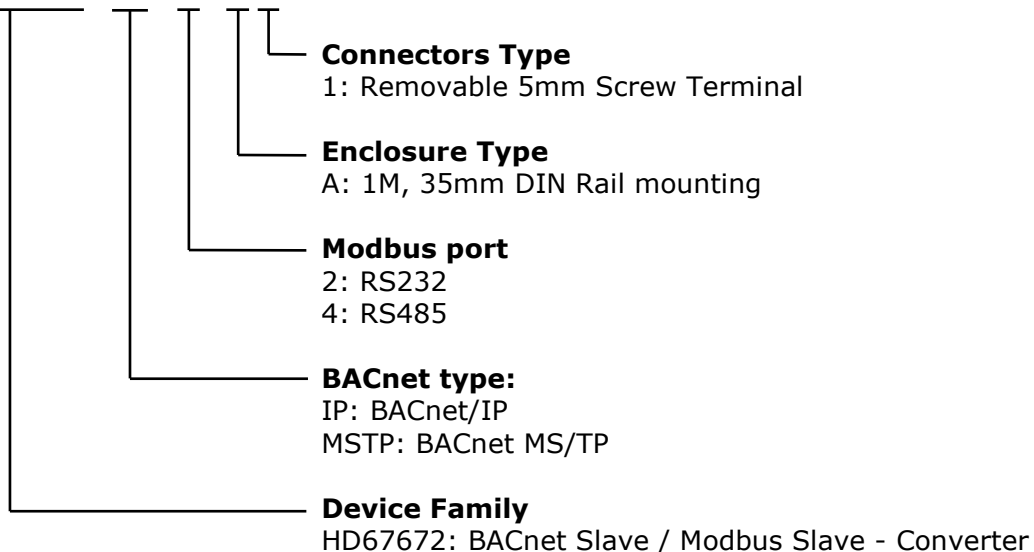

- | | | |
|--------------------------------------|---|---|
| Order Code: HD67672-IP-2-A1 | - | BACnet/IP slave/ Modbus slave – Converter (Modbus over RS232) |
| Order Code: HD67672-IP-4-A1 | - | BACnet/IP slave / Modbus slave – Converter (Modbus over RS485) |
| Order Code: HD67672-MSTP-2-A1 | - | BACnet MS/TP slave / Modbus slave – Converter (Modbus over RS232) |
| Order Code: HD67672-MSTP-4-A1 | - | BACnet MS/TP slave / Modbus slave – Converter (Modbus over RS485) |

ACCESSORIES:

- | | | |
|----------------------------|---|--|
| Order Code: AC34001 | - | 35mm Rail DIN - Power Supply 220/240V AC 50/60Hz – 12 V AC |
| Order Code: AC34002 | - | 35mm Rail DIN - Power Supply 110V AC 50/60Hz – 12 V AC |

DISCLAIMER:

All technical content within this document can be modified without notice. The content of the document is a under continual renewal. For losses due to fire, earthquake, third party access or other accidents, or intentional or accidental abuse, misuse, or use under abnormal conditions repairs are charged to the user. ADFweb.com S.r.l. will not be liable for accidental loss of use or inability to use this product, such as loss of business income. ADFweb.com S.r.l. shall not be liable for consequences of improper use.

OTHER REGULATIONS AND STANDARDS:**WEEE INFORMATION**

Disposal of old electrical and electronic equipment (as in the European Union and other European countries with separate collection systems).

— This symbol on the product or on its packaging indicates that this product may not be treated as household rubbish. Instead, it should be taken to an applicable collection point for the recycling of electrical and electronic equipment. If the product is disposed correctly, you will help prevent potential negative environmental factors and impact of human health, which could otherwise be caused by inappropriate disposal. The recycling of materials will help to conserve natural resources. For more information about recycling this product, please contact your local city office, your household waste disposal service or the shop where you purchased the product.

RESTRICTION OF HAZARDOUS SUBSTANCES DIRECTIVE

The device respects the 2002/95/EC Directive on the restriction of the use of certain hazardous substances in electrical and electronic equipment (commonly referred to as Restriction of Hazardous Substances Directive or RoHS).

CE MARKING

The product conforms with the essential requirements of the applicable EC directives.

WARRANTIES AND TECHNICAL SUPPORT:

For fast and easy technical support for your ADFweb.com SRL products, consult our internet support at www.adfweb.com.
Otherwise contact us at the address support@adfweb.com

RETURN POLICY:

If while using your product you have any problem and you wish to exchange or repair it, please do the following:

- Obtain a Product Return Number (PRN) from our internet support at www.adfweb.com. Together with the request, you need to provide detailed information about the problem.
- Send the product to the address provided with the PRN, having prepaid the shipping costs (shipment costs billed to us will not be accepted).

If the product is within the warranty of twelve months, it will be repaired or exchanged and returned within three weeks. If the product is no longer under warranty, you will receive a repair estimate.



ADFweb.com S.r.l.
Via Strada Nuova, 17
IT-31010 Mareno di Piave
TREVISO (Italy)
Phone +39.0438.30.91.31
Fax +39.0438.49.20.99
www.adfweb.com

