

# User Manual

Revision 3.103  
English

## **CANopen / Modbus Master - Converter**

(Order Code: HD67001)

### **Benefits and Main Features:**

- ▶ Very easy to configure
- ▶ Low cost
- ▶ Master/Slave CANopen
- ▶ Master Modbus
- ▶ Galvanic isolation
- ▶ Industrial temperature range:  
-40°C / 85°C (-40°F / 185°F)



HD67001

Similar  
Products  
→

←  
Benefit

**INDEX:**

	Page
INDEX	2
UPDATED DOCUMENTATION	2
REVISION LIST	2
WARNING	2
TRADEMARKS	2
SECURITY ALERT	3
CONNECTION SCHEME	4
CHARACTERISTICS	7
CONFIGURATION	7
USE OF COMPOSITOR SW67001	7
NEW PROJECT / OPEN PROJECT	8
GENERAL PARAMETER	9
SDO SETTING	10
SDO SETTING BIT	11
PDO SETTING	13
PDO SETTING BIT	15
CREATE EDS FILE	15
UPDATE DEVICE	16
CHARACTERISTICS OF THE CABLES	17
CAN BUS CABLE CHARACTERISTICS	17
MECHANICAL DIMENSIONS	18
ORDER CODE	18
ACCESSORIES	18
DISCLAIMER	19
OTHER REGULATIONS AND STANDARDS	19
WARRANTIES AND TECHNICAL SUPPORT	20
RETURN POLICY	20
PRODUCTS AND RELATED DOCUMENTS	20

**UPDATED DOCUMENTATION:**

Dear customer, we thank you for your attention and we remind you that you need to check that the following document is:

- Updated
- Related to the product you own

To obtain the most recently updated document, note the “document code” that appears at the top right-hand corner of each page of this document.

With this “Document Code” go to web page [www.adfweb.com/download/](http://www.adfweb.com/download/) and search for the corresponding code on the page. Click on the proper “Document Code” and download the updates.

To obtain the updated documentation for the product that you own, note the “Document Code” (Abbreviated written "Doc. Code" on the label on the product) and download the updated from our web site [www.adfweb.com/download/](http://www.adfweb.com/download/)

**REVISION LIST:**

Revision	Date	Author	Chapter	Description
2.000	28/06/2007	Av	All	New document format
3.000	28/08/2007	Av	All	New version of software
3.001	19/06/2008	Av	All	Change figure 2
3.002	13/10/2008	Fl	All	Change figure 2
3.100	19/11/2008	Fl	All	Type M12
3.101	19/01/2009	Fl	All	Revision
3.102	20/06/2009	Ml	All	Revision
3.103	04/04/2013	Nt	All	Added new chapters

**WARNING:**

ADFweb.com reserves the right to change information in this manual about our product without warning.  
ADFweb.com is not responsible for any error this manual may contain.

**TRADEMARKS:**

All trademarks mentioned in this document belong to their respective owners.

**SECURITY ALERT:****GENERAL INFORMATION**

To ensure safe operation, the device must be operated according to the instructions in the manual. When using the device are required for each individual application, legal and safety regulation. The same applies also when using accessories.

**INTENDED USE**

Machines and systems must be designed so the faulty conditions do not lead to a dangerous situation for the operator (i.e. independent limit switches, mechanical interlocks, etc.).

**QUALIFIED PERSONNEL**

The device can be used only by qualified personnel, strictly in accordance with the specifications. Qualified personnel are persons who are familiar with the installation, assembly, commissioning and operation of this equipment and who have appropriate qualifications for their job.

**RESIDUAL RISKS**

The device is state of the art and is safe. The instrument can represent a potential hazard if they are inappropriately installed and operated by personnel untrained. These instructions refer to residual risks with the following symbol:

 This symbol indicates that non-observance of the safety instructions is danger for people to serious injury or death and / or the possibility of damage.

**CE CONFORMITY**

The declaration is made by us. You can send an email to or give us a call if you need it.

**CONNECTION SCHEME:**

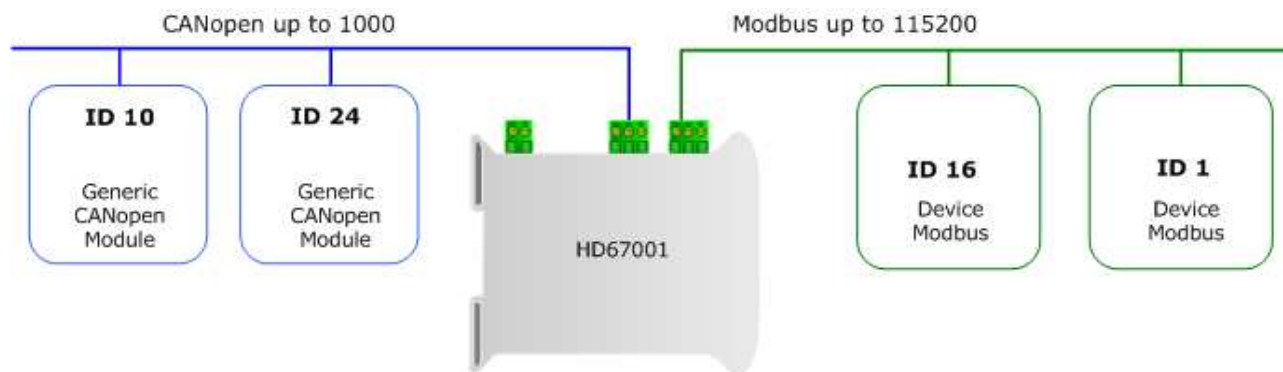

Figure 1: Connection scheme of HD67001 between a CANopen and Modbus RTU

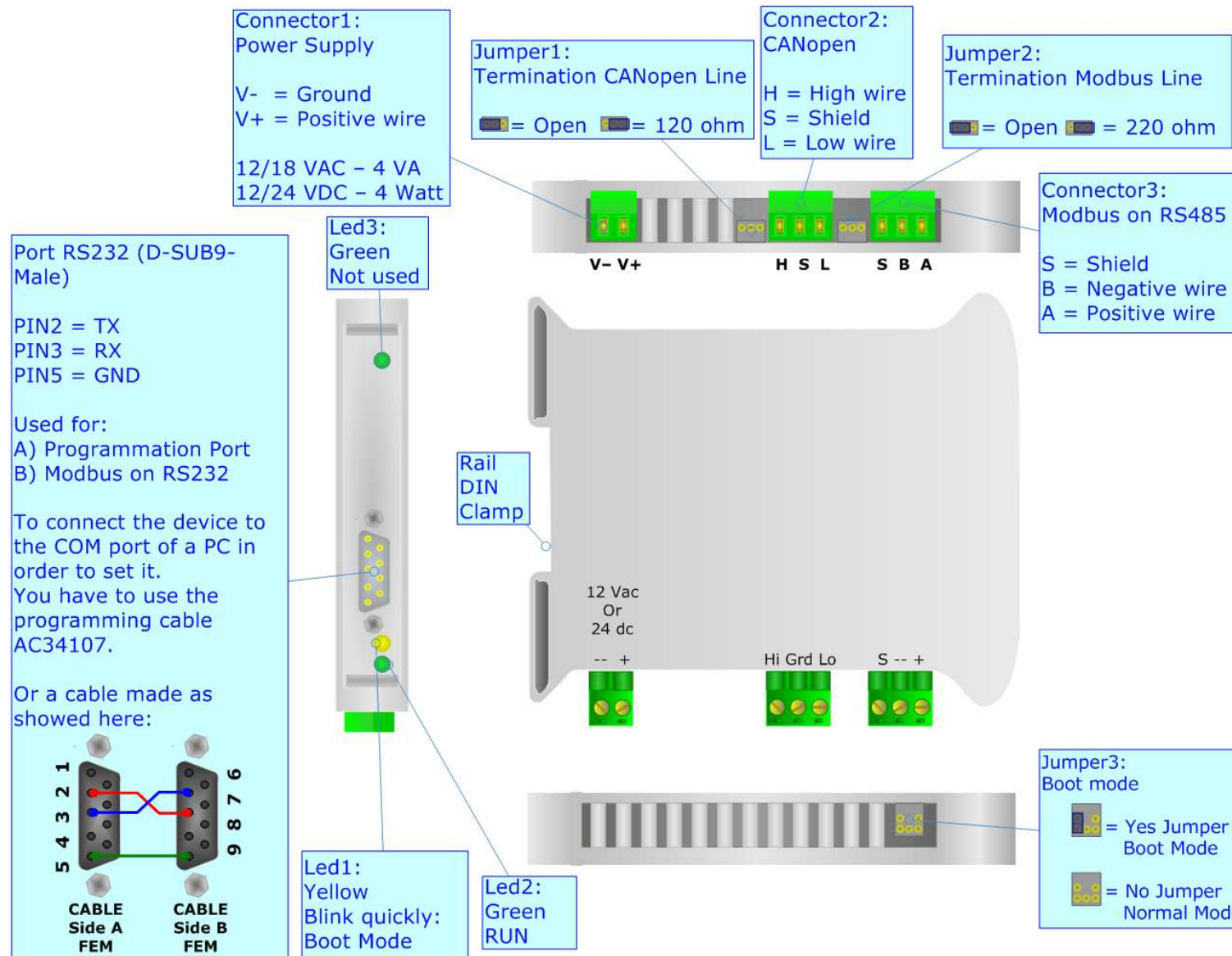

Figure 2: Connection scheme for HD67001

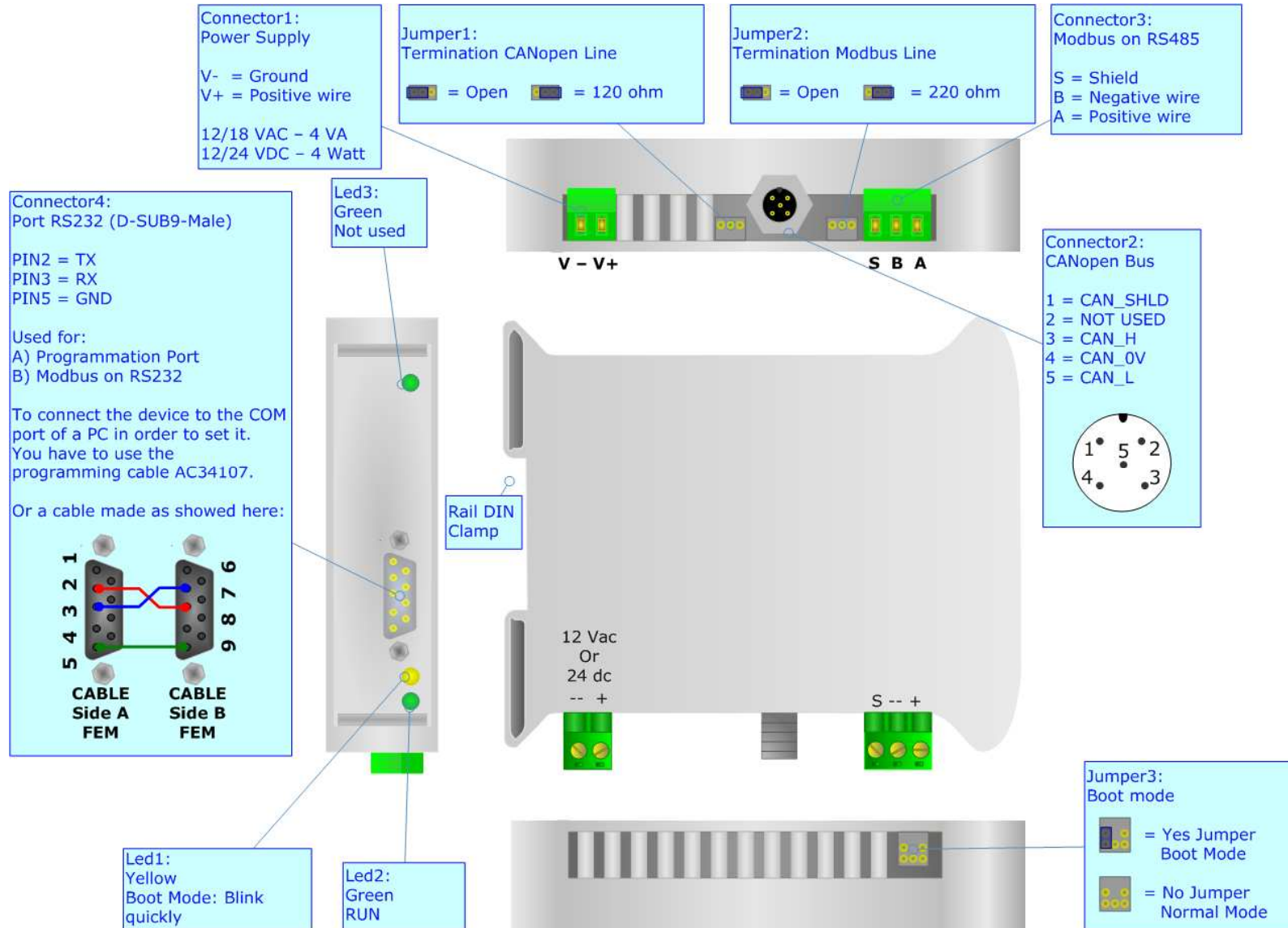

Figure 3: Connection scheme for HD67001-M12

## CHARACTERISTICS:

The CANopen Modbus Master Converter the following characteristics:

- Two-directional information between networks CANopen and ModBUS;
- Galvanic isolation between two BUSES;
- Management of SDO , PDO , Nodeguarding;
- Communication Serial RS485 and or RS232;
- Temperature range -40°C to 85°.

## CONFIGURATION:

The “CANopen / Modbus Master - Converter”, allows a CANopen network to communicate with a Modbus network.

You need Compositor SW67001 software on your PC in order to perform the following:

- Define that the CANopen frame of the CANopen are reading from Modbus;
- Define that the CANopen frame of the CANopen are writing from Modbus.

## USE OF COMPOSITOR SW67001:

To configure the Gateway, use the available software that runs with Windows, called SW67001. It is downloadable on the site [www.adfweb.com](http://www.adfweb.com) and its operation is described in this document.

When launching the SW67001 the right window appears (Fig. 4):



Figure 4: Main window for SW67001

**NEW PROJECT / OPEN PROJECT:**

The "New Project" button creates the folder which contains the entire device configuration.  
A device configuration can also be imported and exported:

- To clone the configurations of a Programmable CANopen to Modbus Gateway in order to configure another device in the same manner, it is necessary to maintain the folder and all its contents;
- To clone a project in order to obtain a different version of the project, it is sufficient to duplicate the project folder with another name and open the new folder with the button "Open Project";
- When a new project is created or an existent project is open, it will be possible to access the various configuration section of the software:
  - **Set Communication;**
  - **SDO Setting;**
  - **PDO Setting.**



**GENERAL PARAMETER:**

This section defines the fundamental communication parameters of two Buses, CANopen and Modbus.

By pressing the "General parameter" button from the main window for SW67001 (Fig. 4) the window "General Parameter" appears (Fig. 5).

- In the field "Device ID", the CANopen address is defined;
- In the fields "Baud Rate", the velocity of the two buses is defined;
- "Send TPDOs on SYNC", if you select this choice when a SYNC command is on the network the device send PDOs;
- The field "Transmission type" define the type of transmission of PDO;
- "Send TPDOs on change" of status. To allow TPDOs automatic transmission when there is a change of the TPDO's variable;
- In the field "Parity", the serial parity is defined;
- "Timeout" is the maximum time that the device attends for the answer from the Slave interrogated;
- Data bits and Stop bits, are a serial parameter and they are fixed in order at 8 and 1 for default;
- The Gateway has two alternative outlets from the Modbus side: RS485 or RS232. Select the desired choice.

Figure 5: "General parameter" window

**SDO SETTING:**

The following objects can be defined in the section "SDO Setting":

- the SDO of the CANopen give access to a word ModBUS.

By pressing the "SDO Setting" button from the main window for SW67001 (Fig. 4) the window "SDO Setting" appears (Fig. 6).

In the right scenario:

- In the field "CANOpen Index", insert the index of the CANopen SDO;
- In the field "Address Device", insert the address of Modbus device that contains the Modbus data;
- In the field "Address word", insert the Register address that contains the Modbus data;
- In the field "Quantity", insert the number of consecutive words you configured;
- In the field "Read/Write", the SDO in reading or in writing is defined;
- In the field "Mnemonic" a description is defined.

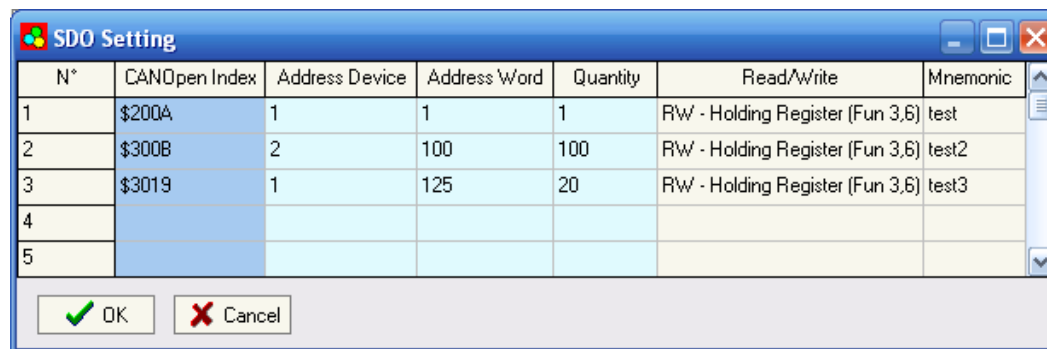

Figure 6: "SDO Setting" window

Example 1:

If I want to read data from the ModBUS network but I'm in a CANopen network :

I'll define an SDO index ( \$300B ) and this will be associated to an area inside Modbus network ( address 100 inside device 2 ).

For reading word 100 on device at address 2 you have to read SDO index \$30B0 subindex 1.

For reading word 101 on device at address 2 you have to read SDO index \$30B0 subindex 2.

Etc.

Field "Quantity" means the number of consecutive location that can be read.

The object \$2100 to 2119 and \$2200 to 2217 are reserved and cannot be used.

All data will be retrived on event read of specific SDO. The master CANopen need to have a timeout higher than 500 ms. The reply time is the time for a serial inquiry plus the serial response.

### SDO SETTING BIT

The following objects can be defined in the section "SDO Setting bit":

- the SDO of the CANopen give access to a ModBUS bits (status).

By pressing the "SDO Setting bit" button from the main window for SW67001 (Fig. 4) the window "SDO Setting bit" appears (Fig. 7).

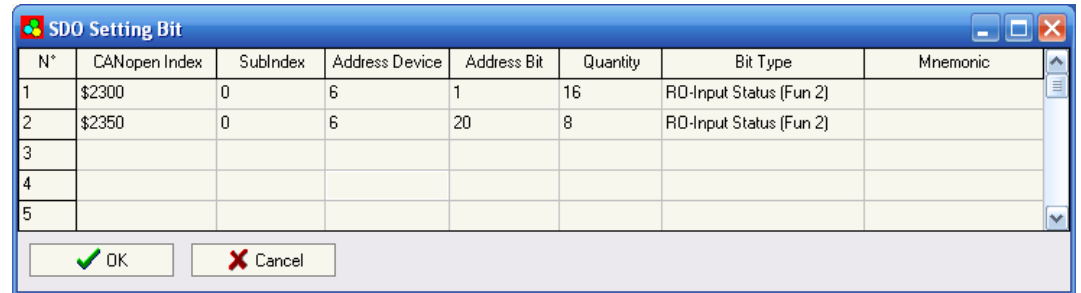

Figure 7: "SDO setting bit" window

In the above scenario:

- In the field "CANOpen Index", insert the index of the CANopen SDO;
- In the field "Subindex", insert the subindex (is suggested to always be 0);
- In the field "Address Device", insert the address of the device that contains the Modbus bits;
- In the field "Address Bit", insert the address of bit that you would like to read or write;
- In the field "Quantity", insert the number of consecutive bits you configured;
- In the field "Bit type", the type of bit is defined;
- In the field "Mnemonic" it is possible to insert a brief description.

For each SDO can be read 16 bits max. (4 bytes: the last 2 bytes are always set to 0).

For each SDO can be written 16 bits max. (4 bytes: 2 data bytes + 2 mask bytes).

```
Data      0001 0001 0011 1111
Mask      0011 0110 1111 1111
Written bits  xx01 x00x 0011 1111 (bits indicated by x are not written).
```

**Example 1:**

If I want to read data from the ModBUS network but I'm in a CANopen network :

I'll define a SDO index ( \$2300 ) and this will be associated to a digital area inside Modbus network ( device 6, starting Modbus address 0, number of reading bits 16).

For reading all 16 bits on device at address 6 you have to read SDO index \$2300 subindex 0.

For reading all 8 bits on device at address 6 you have to read SDO index \$2350 subindex 0.

Etc.

The object \$2100 to 2119 and \$2200 to 2217 are reserved and cannot be used.

All data will be retrived on event read of specific SDO. The master CANopen need to have a timeout higher than 500 ms. The reply time is the time for a serial inquiry plus the serial response.

**PDO SETTING:**

The gateway permit to use 4 Receive PDO and 4 Trasmit PDO. All PDO are mapped to specific object for TPDO1 (\$2100,\$2101,\$2102,\$2103). A PDO has 8 bytes lenght and these are divided in 4 words. Each word is linked to a word in serial bus. Writing an RPDO of gateway, the data will be written into serial device to the specific address. Requesting a TPDO this PDO will contain the data read from serial bus , from a specific device and address.

By pressing the "PDO Setting" button from the main window for SW67001 (Fig. 4) the window "PDO Setting" appears (Fig. 8).

In the right scenario:

- The field "Index" is already compiled and it is not possible to modify it;
- The field "Description" is already compiled and it is not possible to modify it;
- In the field "Add Dev" insert the address of Modbus device;
- In the field "Add Data" insert the address of Modbus Register;
- In the field "Delta Send" insert the delta send range (when at least one Modbus word exceeds ±Delta Send range, the corripodent transmit TPDO will be automatically transmitted);
- In the field "Mnemonc" it is possible to insert a brief description;
- In the field second device ID insert the device ID for PDO5. If the Device ID of your device is 8 (see the section general parameter) the COB ID are:  
 TPDO1=180+Device ID=188  
 TPDO2=280+Device ID=288  
 TPDO4=480+Device ID=488  
 TPDO5=180+second Device ID=184.

For the same reason there is the second device ID on the recive PDO. When you insert the second device ID you do not insert a device ID already present on the network.

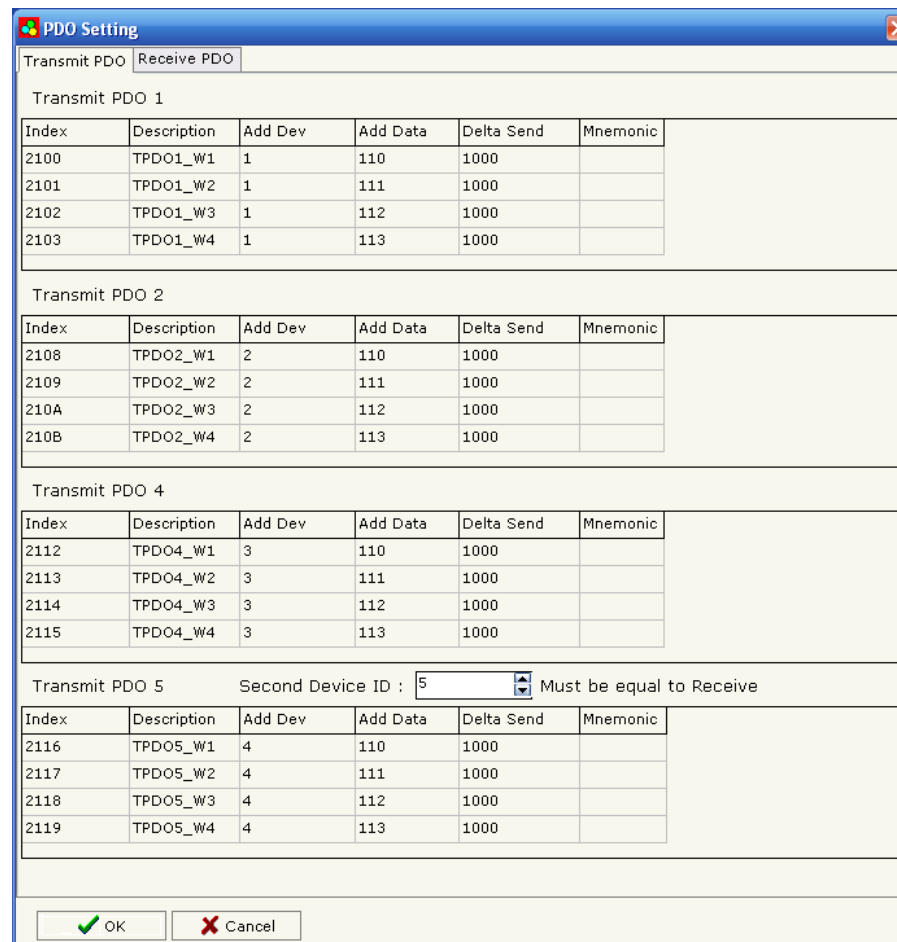

Figure 8: "PDO Setting" window

**Example 1:**

If the initial value is 100 and my delta send is 1000 and the value change to 2000 the device transmit a TPDO because  $2000-100=1900$  and  $1900>1000$ .

If in a second moment the value change to 2100 the device don't send a TPDO, because  $2100-2000=100$  and  $100<1000$ .

### PDO SETTING BIT

The gateway permits to use 1 digital Receive PDO and 1 digital Transmit PDO. TPDO3 is mapped at \$2110. RPDO3 is mapped at \$2111. A PDO has 8 bytes length.

Writing a RPDO of gateway, the data will be written into serial device to the specific address.

Requesting a TPDO this PDO will contain the data read from serial bus, from a specific device and address.

By pressing the "PDO Setting bit" button from the main window for SW67001 (Fig. 4) the window "PDO Setting bit" appears (Fig. 9).

In the right scenario:

- The field "Address device" insert the address of device that contain the bits;
- The field "Address bit" insert the address of bit that you would like to read;
- In the field "Quantity" insert the number of consecutive bits you configured;
- In the field "Bit Type" the type of bit is defined;
- In the field "Mnemonic" you can insert a brief description;
- In the field "Mask for automatic SEND of PDO" insert a mask.

```
Data      0001 0001 0011 1111 0001 0001 0011 1111
Mask      0011 0110 1111 1111 0011 1110 1110 1111
Written bits  xx01 x00x 0011 1111 xx01 000x 001x 1111
(bits indicated by x are not written)
```

For the TPDO can be read from the protocol converter 64 bits max. (8data bytes).

For the RPDO can be written to protocol converter 32 bits max. (8 bytes: 4 data bytes + 4 mask bytes).

### CREATE EDS FILE

By clicking on this button the user can create a valid EDS file.

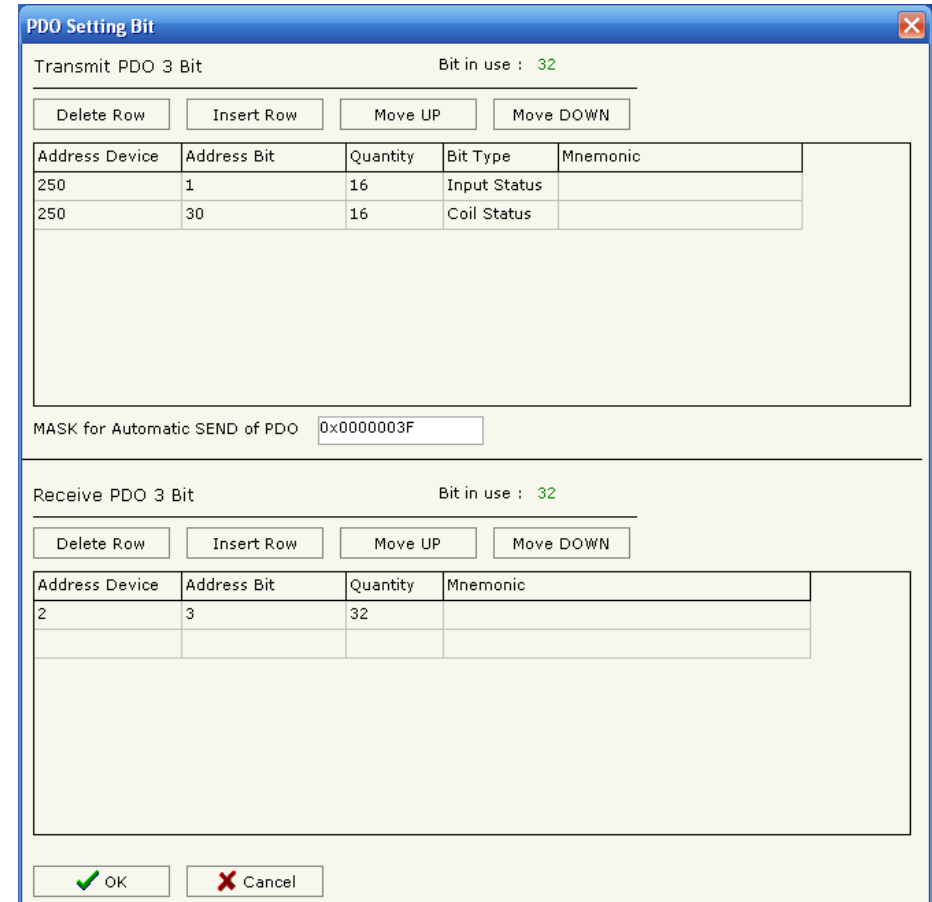

Figure 9: "PDO Setting bit" window

**UPDATE DEVICE:**

Section "Update Device":

Insert the boot jumper (see Figure 2).

In order to load the parameters after they are set, set the Com port you used for update, you must click the button "Execute update firmware" on the principal window.

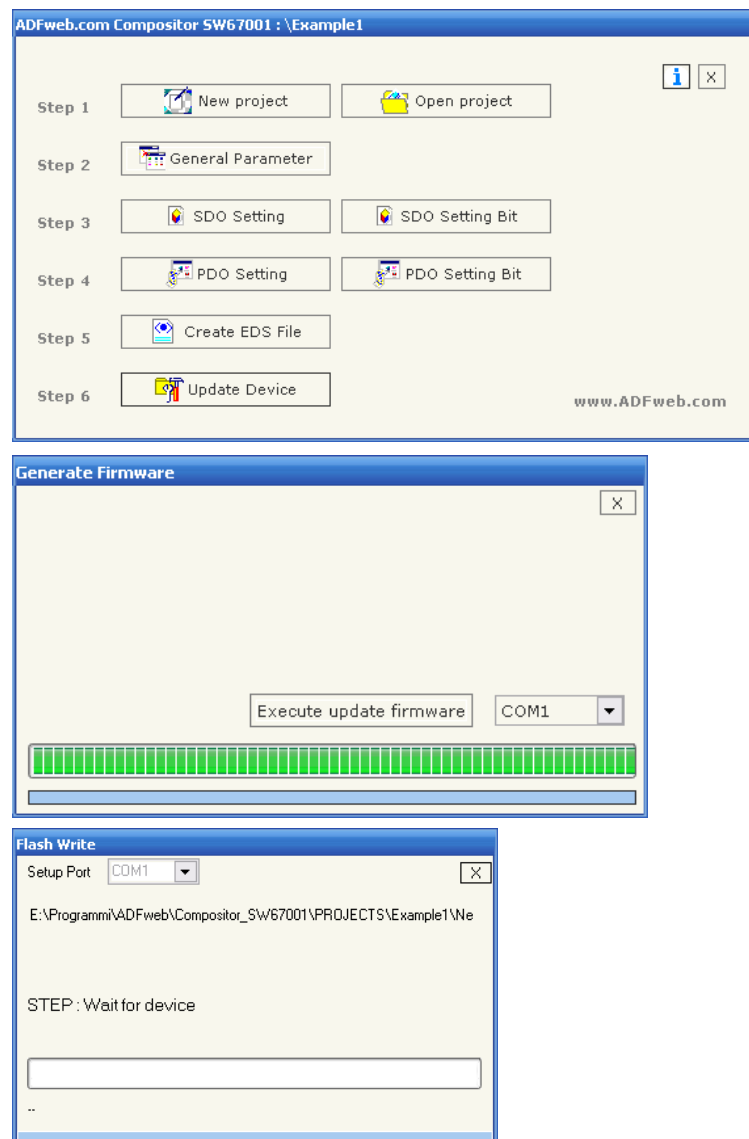

Figure 10: Update device procedure



**CHARACTERISTICS OF THE CABLES:**

The connection from RS232 socket to a serial port (example one from a personal computer), must be made with a Null Modem cable (a serial cable where the pins 2 and 3 are crossed).  
It is recommended that the RS232C Cable not exceed 15 meters.

**CAN BUS CABLE CHARACTERISTICS:**

DC parameter:	Impedance	70 Ohm/m
AC parameters:	Impedance	120 Ohm/m
	delay	5 ns/m
Length	Baud Rate [bps]	Length MAX [m]
	10 K	5000
	20 K	2500
	50 K	1000
	100 K	650
	125 K	500
	250 K	250
	500 K	100
	800 K	50
	1000 K	25

**MECHANICAL DIMENSIONS:**

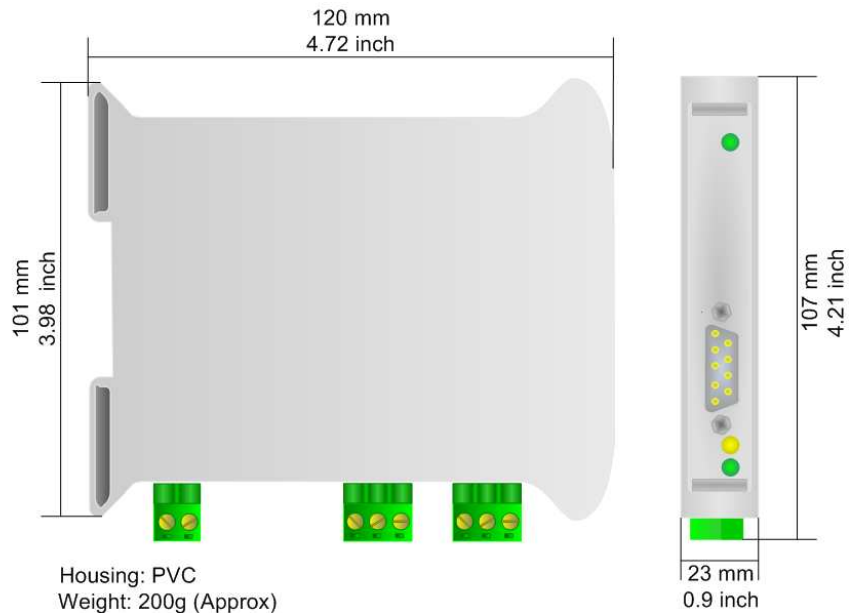

Figure 11: Mechanical dimensions scheme for HD67001

**ORDER CODE:**

Order Code: **HD67001** - CANopen / Modbus Master - Converter (CAN connector: Terminal block)

**ACCESSORIES:**

Order Code: **AC34107** - Null Modem Cable Fem/Fem DSub 9 Pin 1,5 m

Order Code: **AC34114** - Null Modem Cable Fem/Fem DSub 9 Pin 5 m

Order Code: **AC34001** - Rail DIN - Power Supply 220/240V AC 50/60Hz – 12 V AC

Order Code: **AC34002** - Rail DIN - Power Supply 110V AC 50/60Hz – 12 V AC

## DISCLAIMER

All technical content within this document can be modified without notice. The content of the document content is a recurring audit. For losses due to fire, earthquake, third party access or other accidents, or intentional or accidental abuse, misuse, or use under abnormal conditions repairs are charged to the user. ADFweb.com S.r.l. will not be liable for accidental loss of use or inability to use this product, such as loss of business income. ADFweb.com S.r.l. shall not be liable for consequences of improper use.

## OTHER REGULATIONS AND STANDARDS

### WEEE INFORMATION



Disposal of old electrical and electronic equipment (as in the European Union and other European countries with separate collection systems).

This symbol on the product or on its packaging indicates that this product may not be treated as household rubbish. Instead, it should be taken to an applicable collection point for the recycling of electrical and electronic equipment. If the product is disposed correctly, you will help prevent potential negative environmental factors and human health, which could otherwise be caused by inappropriate disposal. The recycling of materials will help to conserve natural resources. For more information about recycling this product, please contact your local city office, your household waste disposal service or the shop where you purchased the product.

### RESTRICTION OF HAZARDOUS SUBSTANCES DIRECTIVE



The device respects the 2002/95/EC Directive on the restriction of the use of certain hazardous substances in electrical and electronic equipment (commonly referred to as Restriction of Hazardous Substances Directive or RoHS).

### CE MARKING



The product conforms with the essential requirements of the applicable EC directives.

### WARRANTIES AND TECHNICAL SUPPORT:

For fast and easy technical support for your ADFweb.com SRL products, consult our internet support at [www.adfweb.com](http://www.adfweb.com).

Otherwise contact us at the address [support@adfweb.com](mailto:support@adfweb.com)

### RETURN POLICY:

If while using your product you have any problem and you wish to exchange or repair it, please do the following:

- 1) Obtain a Product Return Number (PRN) from our internet support at [www.adfweb.com](http://www.adfweb.com). Together with the request, you need to provide detailed information about the problem.
- 2) Send the product to the address provided with the PRN, having prepaid the shipping costs (shipment costs billed to us will not be accepted).

If the product is within the warranty of twelve months, it will be repaired or exchanged and returned within three weeks.

If the product is no longer under warranty, you will receive a repair estimate.

### PRODUCTS AND RELATED DOCUMENTS:

Part	Description	URL
HD67121	Gateway CANopen / Canopen	<a href="http://www.adfweb.com?product=HD67121">www.adfweb.com?product=HD67121</a>
HD67502	Gateway CANopen / Modbus - RTU	<a href="http://www.adfweb.com?product=HD67502">www.adfweb.com?product=HD67502</a>
HD67505	Gateway CANopen / Modbus - Ethernet TCP	<a href="http://www.adfweb.com?product=HD67505">www.adfweb.com?product=HD67505</a>
HD67134	Gateway CANopen / DeviceNet	<a href="http://www.adfweb.com?product=HD67134">www.adfweb.com?product=HD67134</a>
HD67117	CAN bus Repeater	<a href="http://www.adfweb.com?product=HD67117">www.adfweb.com?product=HD67117</a>
HD67216	CAN bus Analyzer	<a href="http://www.adfweb.com?product=HD67216">www.adfweb.com?product=HD67216</a>