

# User Manual

Revision 3.103  
English

## CANopen / Modbus Slave - Converter

(Order Code: HD67002 – HD67002-M12)

### Benefits and Main Features:

- ▶ Very easy to configure
- ▶ Low Cost
- ▶ Master/Slave CANopen
- ▶ Slave Modbus
- ▶ Galvanic isolation
- ▶ Industrial temperature range:  
-40°C / 85°C (-40°F / 185°F)



HD67002

Similar Products  
→

←  
Benefit

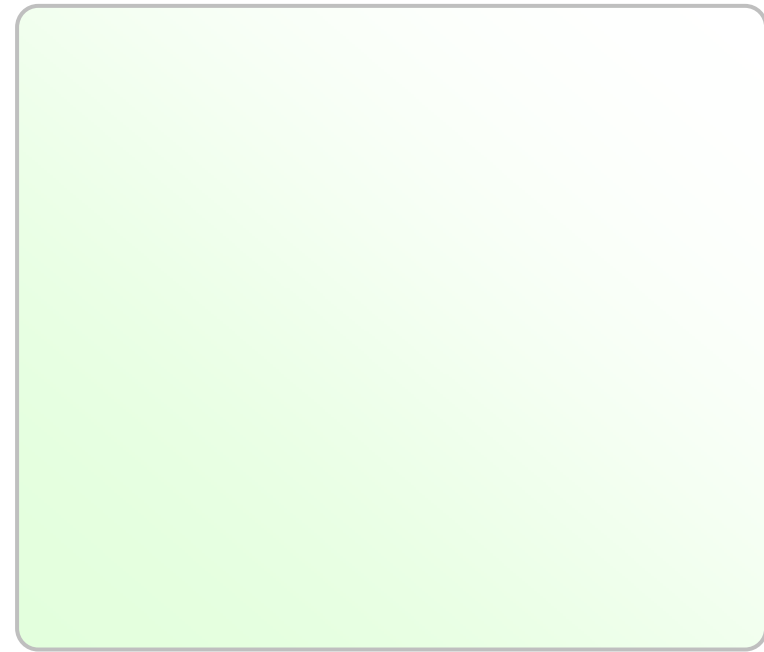

**INDEX:**

	Page
INDEX	2
UPDATED DOCUMENTATION	2
REVISION LIST	2
WARNING	2
TRADEMARKS	2
SECURITY ALERT	3
CHARACTERISTICS	4
CONNECTION SCHEME	5
CONFIGURATION	8
USE OF COMPOSITOR SW67002	8
NEW PROJECT / OPEN PROJECT	9
SET COMMUNICATION	10
SET SDO ACCESS	11
SET TRANSLATE EMCY	14
DEFINE EMCY WORD	15
SET TRANSLATE PDO	16
DEFINE STORE PDO	16
SET TRANSMIT PDO	17
SET NODE GUARDING	18
UPDATE DEVICE	19
CHARACTERISTICS OF THE CABLES	20
MECHANICAL DIMENSIONS	21
ORDER CODE	21
ACCESSORIES	21
DISCLAIMER	22
OTHER REGULATIONS AND STANDARDS	22
WARRANTIES AND TECHNICAL SUPPORT	23
RETURN POLICY	23
PRODUCTS AND RELATED DOCUMENTS	23

**UPDATED DOCUMENTATION:**

Dear customer, we thank you for your attention and we remind you that you need to check that the following document is:

- Updated
- Related to the product you own

To obtain the most recently updated document, note the “document code” that appears at the top right-hand corner of each page of this document.

With this “Document Code” go to web page [www.adfweb.com/download/](http://www.adfweb.com/download/) and search for the corresponding code on the page. Click on the proper “Document Code” and download the updates.

To obtain the updated documentation for the product that you own, note the “Document Code” (Abbreviated written “Doc. Code” on the label on the product) and download the updated from our web site [www.adfweb.com/download/](http://www.adfweb.com/download/)

**REVISION LIST:**

Revision	Date	Author	Chapter	Description
1.100	26/06/2007	Av	All	Software changed
2.000	05/06/2007	Av	All	New document format
3.000	09/11/2007	Av	All	New software version
3.001	19/06/2008	Av	All	Change figure 2
3.002	13/10/2008	Fl	All	New software version
3.100	19/11/2008	Fl	All	Type M12
3.101	19/01/2009	Fl	All	Revision
3.102	18/06/2009	MI	All	Revision
3.103	04/04/2013	Nt	All	Added new chapters

**WARNING:**

ADFweb.com reserves the right to change information in this manual about our product without warning.  
ADFweb.com is not responsible for any error this manual may contain.

**TRADEMARKS:**

All trademarks mentioned in this document belong to their respective owners.

**SECURITY ALERT:****GENERAL INFORMATION**

To ensure safe operation, the device must be operated according to the instructions in the manual. When using the device are required for each individual application, legal and safety regulation. The same applies also when using accessories.

**INTENDED USE**

Machines and systems must be designed so the faulty conditions do not lead to a dangerous situation for the operator (i.e. independent limit switches, mechanical interlocks, etc.).

**QUALIFIED PERSONNEL**

The device can be used only by qualified personnel, strictly in accordance with the specifications.

Qualified personnel are persons who are familiar with the installation, assembly, commissioning and operation of this equipment and who have appropriate qualifications for their job.

**RESIDUAL RISKS**

The device is state of the art and is safe. The instrument can represent a potential hazard if they are inappropriately installed and operated by personnel untrained. These instructions refer to residual risks with the following symbol:

 This symbol indicates that non-observance of the safety instructions is danger for people to serious injury or death and / or the possibility of damage.

**CE CONFORMITY**

The declaration is made by us. You can send an email to or give us a call if you need it.

**CHARACTERISTICS:**

The Configurable CANopen Modbus RTU Slave Converter allows the following characteristics:

- two-directional information between networks CANopen and ModBUS;
- electrical isolation between two BUSES;
- to write SDO from ModBUS Word;
- to read SDO from ModBUS Word;
- to read EMCY from ModBUS Word;
- to read PDO from ModBUS Word;
- Communication Serial RS232/485 ;
- Temperature range -40°C to 85°C.

The Gateway can be configured up to a maximum 1600 SDO.

While the maximum number of the following:

- EMCY
- EMCY Word
- PDO
- Store PDO

depends on the available memory of the Gateway and the number defined SDO.

**CONNECTION SCHEME:**

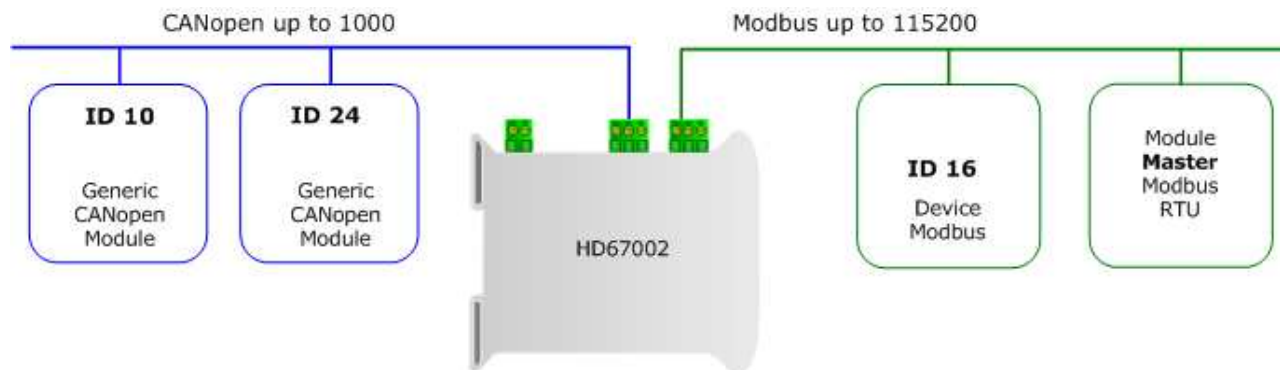

Figure 1: Connection scheme of HD67002 between a CANopen and Modbus TCP

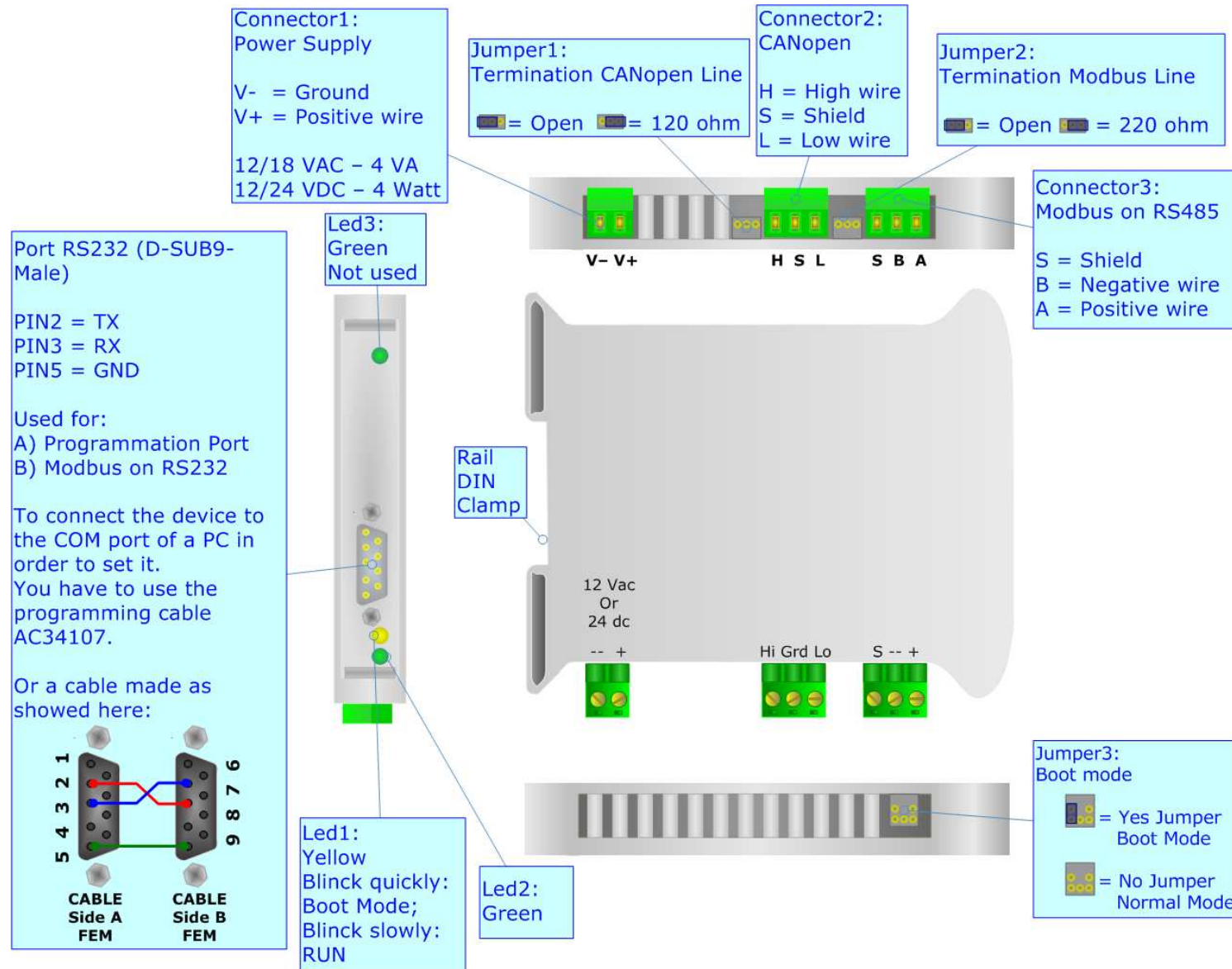

Figure 2: Connection Scheme for HD67002

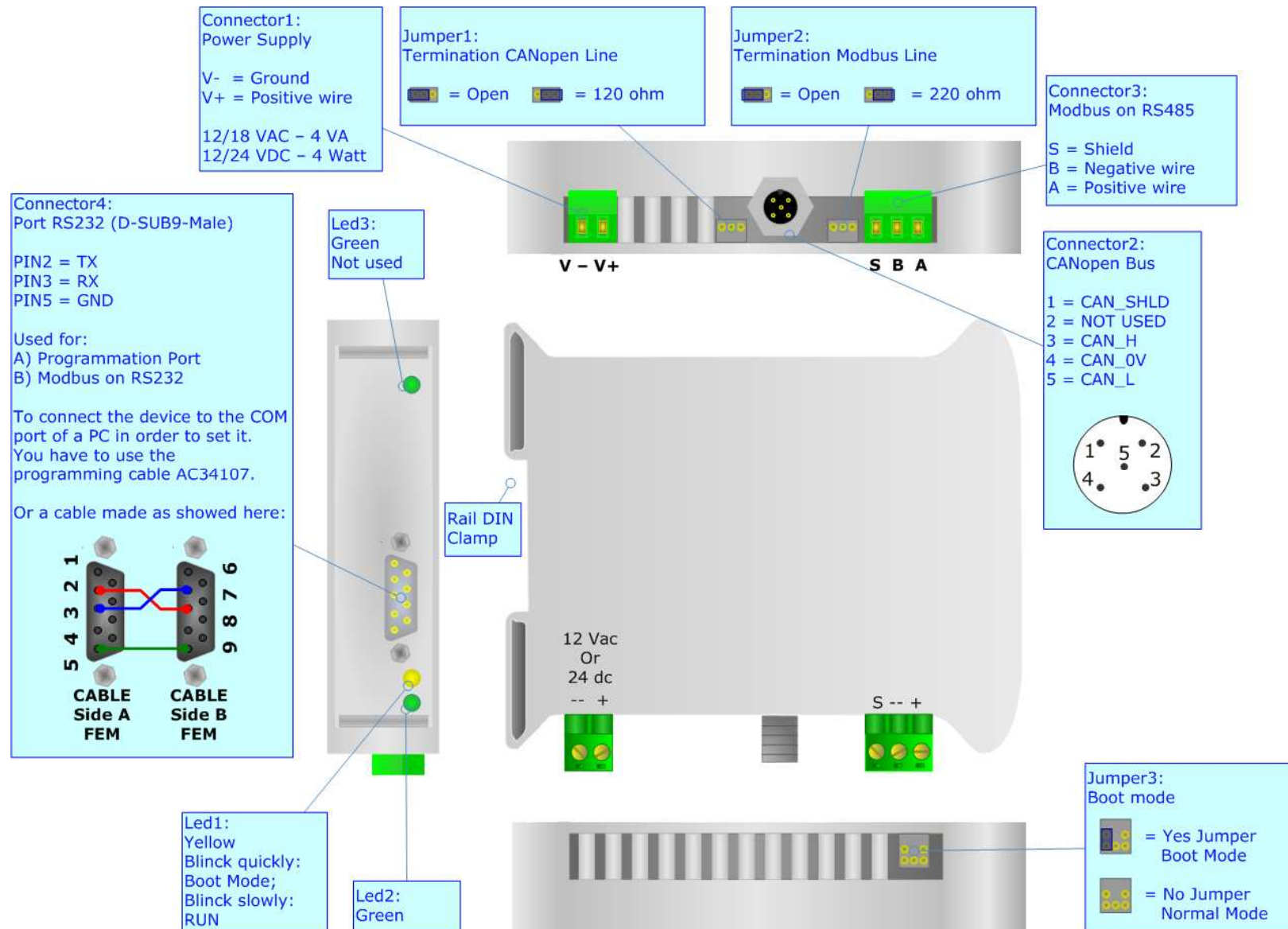

Figure 3: Connection Scheme for HD67002-M12

## CONFIGURATION:

The "Gateway CANopen to Modbus", allows a CANopen network to communicate with a Modbus network.

You need Compositor SW67002 software on your PC in order to perform the following:

- Define that the SDO of the CANopen are accessible from Modbus;
- Define how to update SDO in CANopen from Modbus;
- Define that the EMCY of the CANopen are accessible from Modbus;
- Define how and which EMCY generated in CANopen can be filtered;
- Define which and how the PDO of CANopen are accessible from Modbus;
- Update the new configurations of the device;
- Save, duplicate, modify, export the configurations.

## USE OF COMPOSITOR SW67002:

To configure the Gateway, use the available software that runs with Windows, called SW67002

(The SW67002 is downloadable on the site <http://www.adfweb.com/home/download/download.asp>).

When launching the SW67002 the right window appears:

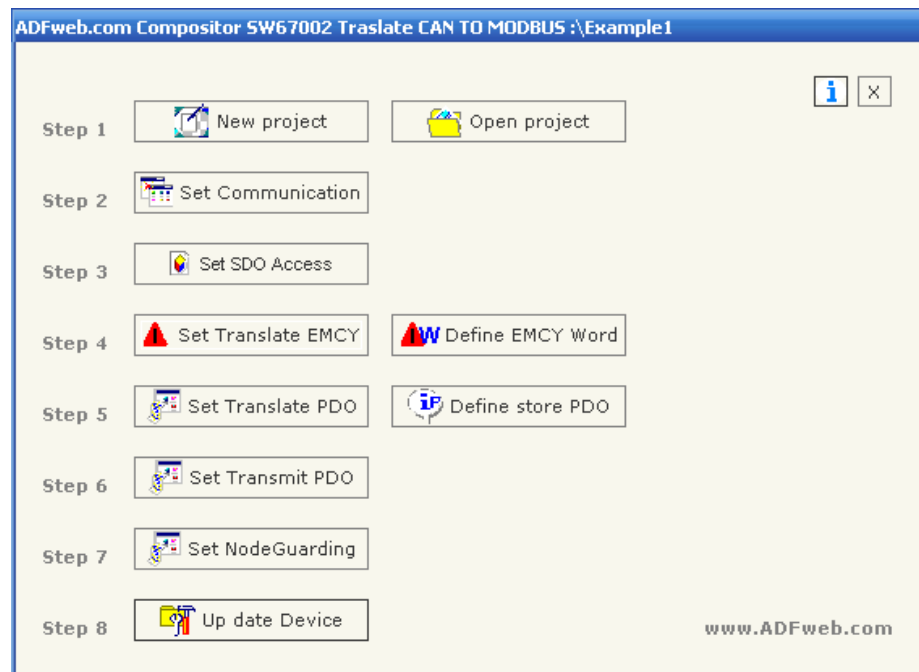

Figure 4: Main window for SW67002



**NEW PROJECT / OPEN PROJECT:**

The “New Project” button creates the folder which contains the entire device configuration.  
A device configuration can also be imported and exported:

- To clone the configurations of a Programmable CANopen to Modbus Gateway in order to configure another device in the same manner, it is necessary to maintain the folder and all its contents;
- To clone a project in order to obtain a different version of the project, it is sufficient to duplicate the project folder with another name and open the new folder with the button “Open Project”.

When a new project is created or an existent project is open, it will be possible to access the various configuration sections of the software:

- **“Set Communication”** ;
- **“Set SDO Access”** ;
- **“Set Translate EMCY”**:
  - Otherwise the **Define EMCY Word**;
- **“Set Translate PDO”**:
  - Otherwise the **Define Store PDO**.

## SET COMMUNICATION:

This section defines the fundamental communication parameters of two Buses, CANopen and Modbus.

By pressing the "Set Communication" button from the main window for SW67002 (Fig. 4) the window "Set communication" appears (Fig. 5):

- In the fields "DevID", the Gateway address is defined in the respective CANopen and Modbus;
- In the fields "Baud Rate", the velocity of the two Buses is defined;
- The check box "Set Operational State at Start-Up" is used to set the operational state of the device at start-up;
- The check box "Network Start at Start-Up" is used to send the command of the operational to the CANopen Network (i.e. when the device start up sen at Modbus Network a command and all device is in operational);
- In the field "Delay" the delay before send the network command for the CANopen is defined;
- The check box "Can Start on Modbus Command" is used to send the Modbus command (sender word) of Operational/Pre-Operational State to one or all devices in CAN network.
  - The sender word must have:
    - The high byte with the value of 1 for Operational or 2 for Pre-Operational.
    - The low byte must have the address of the device that is commanded to do the action (Operational/PreOperational)
      - Example if you want to set the state of Operational to the device CANopen with address 3, You must write the word "259" in the field "Add. Word Modbus".  
Note: 257=0x01.11.
    - If in the field "Add. Word Modbus" you set 0, then this action commands all the devices.
- The Gateway has two alternative for PDO: 15RPDO and 3RPDO or 8 RPDO and 8 TPDO. Select the desired choice;
- The Gateway has two alternative outlets from the Modbus side: RS485 or RS232. Select the desired choice;
- In the field "Parity", the serial parity is defined;
- "SDO Timeout" is the maximum time that the device attends for the answer from the Slave interrogated;
- Data bits and Stop bits, are a serial parameter and they are fixed in order at 8 and 1 for default.

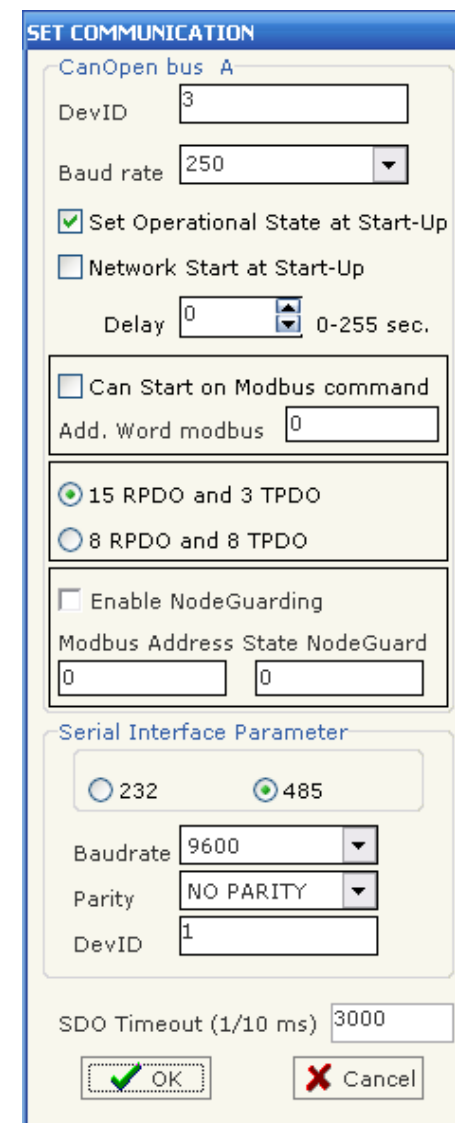

Figure 5: "Set communication" window

## SET SDO ACCESS:

### Section "Set SDO Access"

The following objects can be defined within the section "Set SDO Access":

- the SDO of the CANopen are accessible from a word ModBUS;
- Which word of the ModBUS are accessible from a SDO of the CANopen.

By pressing the "Set SDO Access" button from the Main Window for SW67002 (Fig. 4) the window "SDO" appears (Fig. 6).

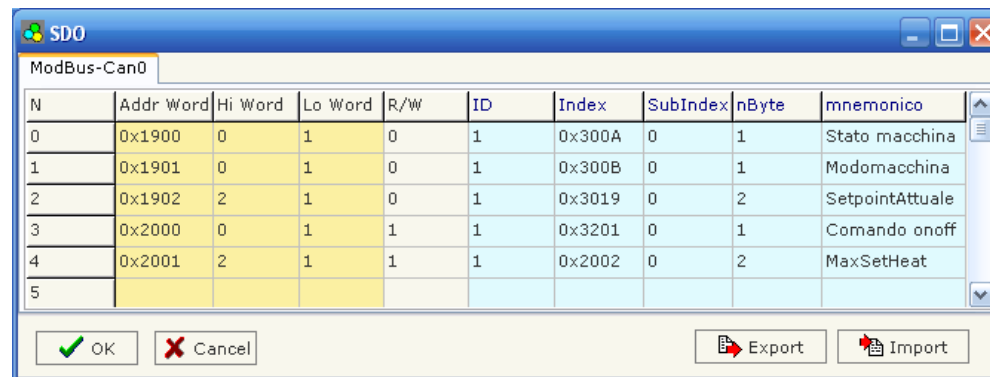

N	Addr Word	Hi Word	Lo Word	R/W	ID	Index	SubIndex	nByte	mnemonic
0	0x1900	0	1	0	1	0x300A	0	1	Stato macchina
1	0x1901	0	1	0	1	0x300B	0	1	Modomacchina
2	0x1902	2	1	0	1	0x3019	0	2	SetpointAttuale
3	0x2000	0	1	1	1	0x3201	0	1	Comando onoff
4	0x2001	2	1	1	1	0x2002	0	2	MaxSetHeat
5									

Figure 6: "SDO" window

The data of the columns have the following meanings:

- In the field "Addr Word" insert the address of the SDO that supports the ModBUS word;
- In the field "Hi Word" insert the correspondence between the high byte of the ModBUS word and a SDO byte (note: its number can be 0, 1, 2, 3, 4)
  - 1 = First byte of the SDO;
  - 2 = Second byte of the SDO;
  - 3 = Third byte of the SDO;
  - 4 = Fourth byte of the SDO;
  - 0 = No byte.
- In the field "Lo word" insert the correspondence between the low byte of the ModBUS word and a SDO byte (note: its number can be 0, 1, 2, 3, 4)
  - 1 = First byte of the SDO;
  - 2 = Second byte of the SDO;
  - 3 = Third byte of the SDO;
  - 4 = Fourth byte of the SDO;
  - 0 = No byte.
- In the field "R/W" insert number "0" if the SDO is only in reading or insert number "1" if the SDO is also in writing;
- In the field "ID" insert the address of the CANopen device;
- In the fields "index", "SubIndex" there are the coordinates of the SDO in the CANopen;
- In the field "nbyte" indicates the length of the SDO;
- In the field "Mnemonic" it is possible to insert a brief description.

Example 1:

If you want to write data in the form of SDO in the CANopen from the ModBUS network on the device at the address:

- Address 16;
- Index 0x2003;
- Subindex 0;
- By dimensions 2 bytes;
- By the following word ModBUS;
- Addr Word 3000.

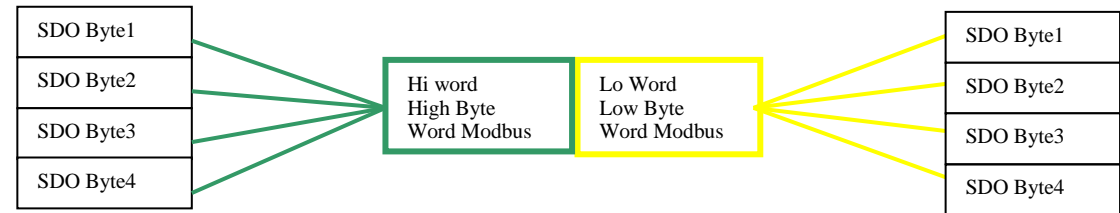

Figure 7: Scheme of the word configuration

In the above scenario (Fig. 7):

The Modbus master can read or write (note RW=1):

- to the address of the ModBUS side Gateway slave (note the one specified in the "Set communication");
- to the word ModBUS 3000 (note: Addr word 3000);
- the first byte of the SDO found in the low byte of the ModBUS word (note: Lo Word=1);
- the second byte of the SDO found in high byte of the ModBUS word (note: Hi Word=2).

The SDO:

- two byte dimension (note: nByte=2);
- belonging to a CANopen device ID 16 (note: ID=16);
- of the following coordinates: Index 2003 and Subindex 0.

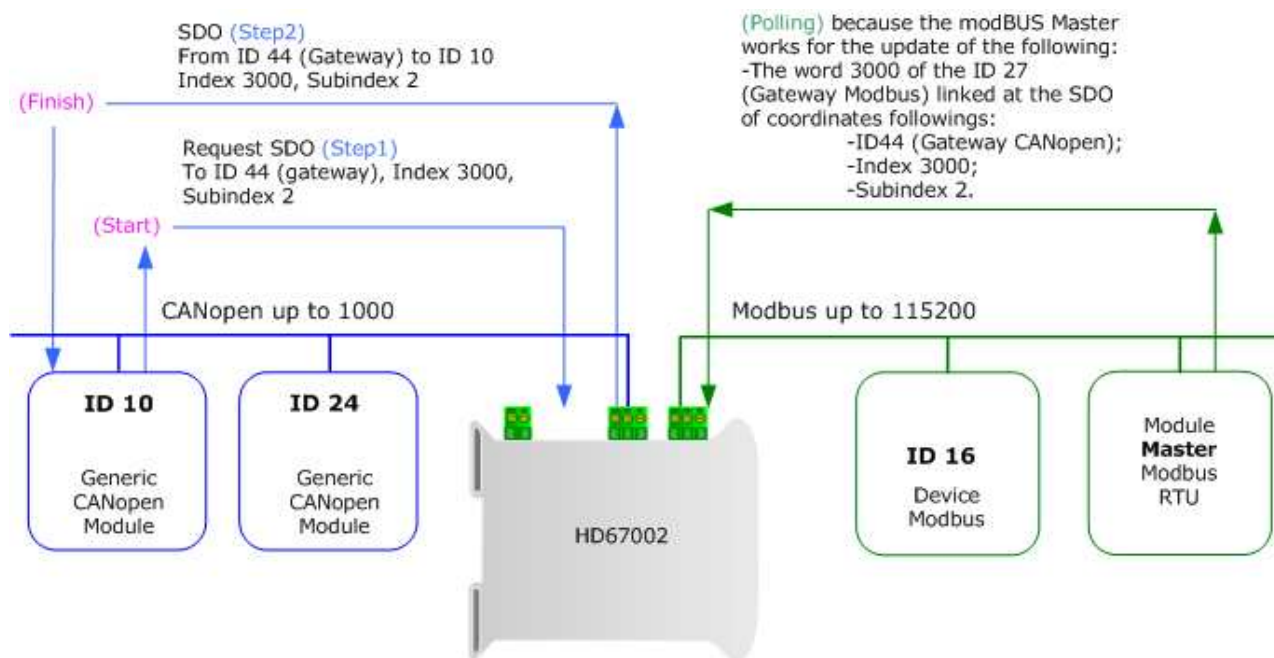

Figure 8: Chart of SDO request from Modbus side

**SET TRANSLATE EMCY:**

By pressing the "Set Translate EMCY" button from the Main Window for SW67005 (Fig. 4) the window "Set Translate EMCY" appears (Fig. 9):

A user who has to pass a EMCY from CAN open to Modbus needs to insert the coordinates of the EMCY to be transmitted in the field "Set Translate EMCY" of the window.

- In the field "**ID EMCY**" insert the Node ID of your CANopen device who transmit the EMCY;
- In the field "**EMCY Error Code**" insert the value of your error code (the maximum value is 0xFFFF);
- In the field "**Error Register**" insert the value of your error register (the maximum value is 0xFF).

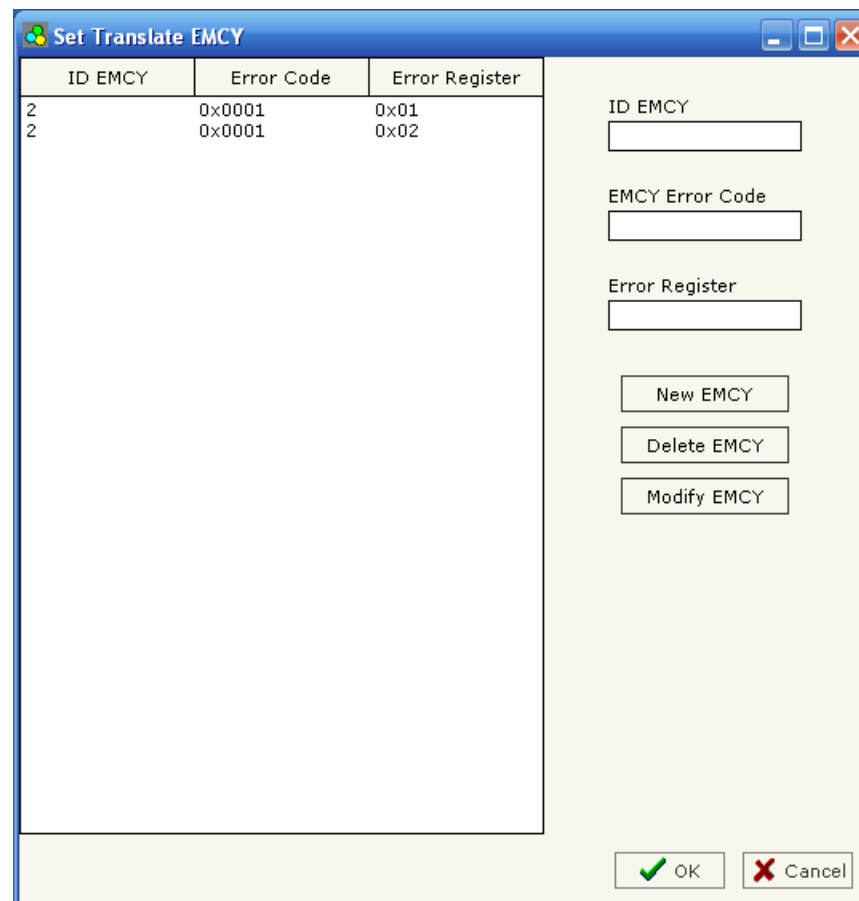

Figure 9: "Set Translate EMCY" window

**DEFINE EMCY WORD:**

By pressing the "Define EMCY word" button from the Main Window for SW67002 (Fig. 4) the window "Word EMCY" appears (Fig. 10):

- In the field "**List of EMCY**" there are the EMCY that you insert in the list of window "Set translate EMCY";
- In the field "**List of Modbus Register**" there are the Modbus register that you insert;
- In the field "**Number of Modbus register**" insert the number of register that contain the Modbus word;
- In the field "**Hi byte of Modbus register**" select which byte you would locate in the Hi position;
- In the field "**Lo byte of Modbus register**" select which byte you would locate in the Lo position.

For example:

Click on the List of EMCY, insert the valid address in the field "Number of Modbus register", select the byte position (First byte in "Hi byte of Modbus register" and Second Byte in "Lo byte of Modbus register"), click the "New" button, then in the field "List of Modbus Register" the number of Modbus register appears.

The maximum number of setting byte are 500.

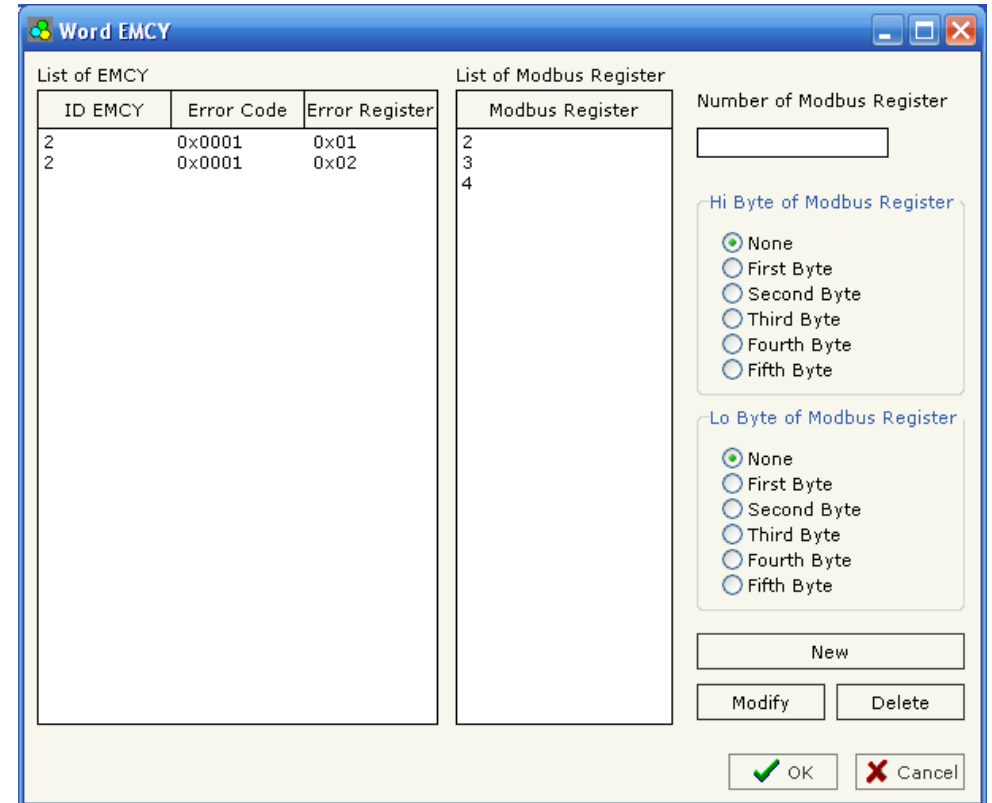

Figure 10: "Word EMCY" window

**SET TRANSLATE PDO:**

By pressing the "Set Translate PDO" button from the Main Window for SW67002 (Fig. 4) the window "RPDO" appears (Fig. 11):

The user who has to memorize a PDO from CAN open to Modbus needs to insert the coordinates of the PDO to be transmitted in the field "SET Translate PDO" of the window.

- In the field "**cobid**" insert the Cob\_ID of the original PDO;
- In the field "**id\_dev\_ori**" insert the address of the original device of **BUS A** (note: an alias can be inserted in the field instead of the actual address of the PDO generator);
- In the field "**dimension**" insert the number of byte of PDO.

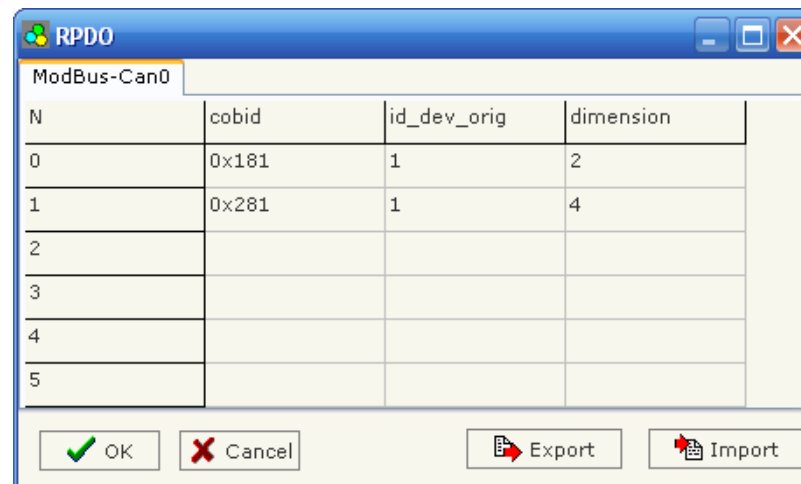

Figure 11: "RPDO" window

**DEFINE STORE PDO:**

By pressing the "Define store PDO" button from the Main Window for SW67002 (Fig. 4) the window "INFOPDO" appears (Fig. 12):

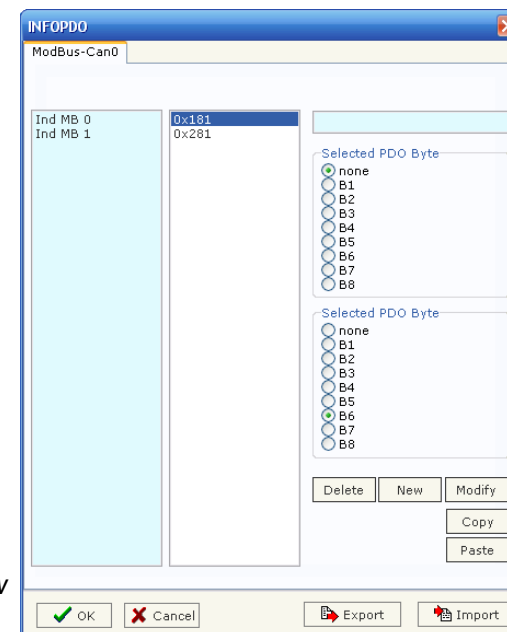

Figure 12: "INFOPDO" window



**SET TRANSMIT PDO:**

It is possible to write the PDOs using the Preset Multiple Registers Function (Modbus function 16). You have to write all the Modbus register (that represent the PDO Data) with one Modbus command.

By pressing "Set Transmit PDO" button the window "Transmit PDO" appears.

The User who has to write a PDO from Modbus to CANopen needs to insert the coordinates of the PDO to be transmitted in the field "SET Transmit PDO" of the window.

- In the field "**COB-ID**" insert the COB-ID of the PDO;
- In the field "**Dimension**" insert the number of byte of PDO;
- In the field "**Start Modbus Address**" insert the number of Modbus register that you would like to start for writing the PDO.

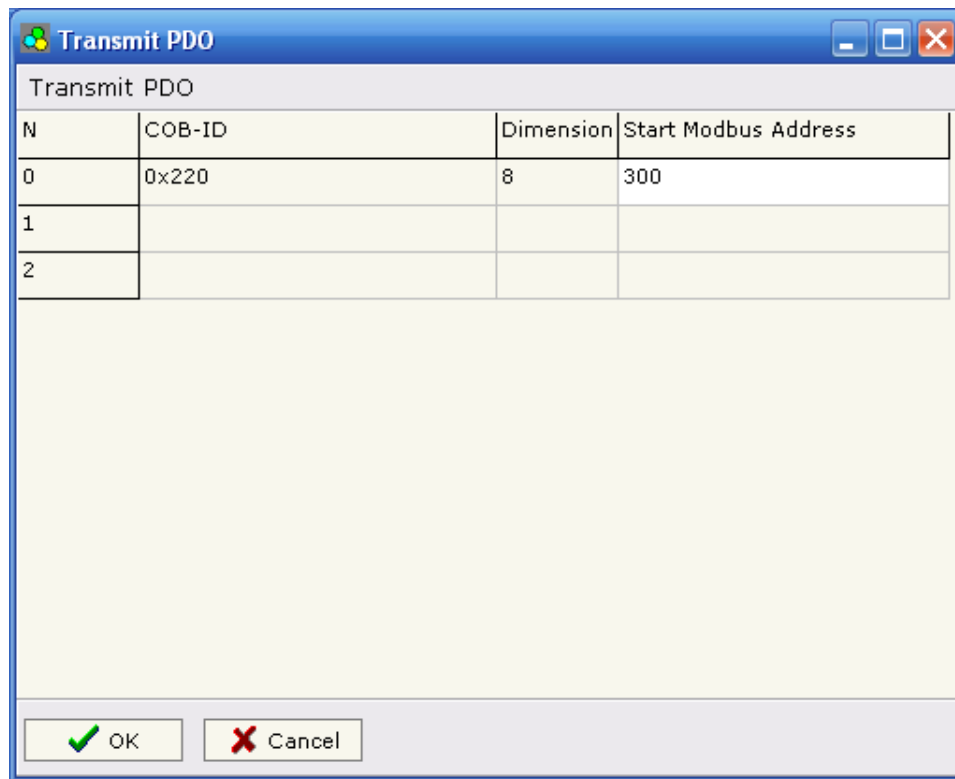

Figure 13: "Transmit PDO" window

### SET NODE GUARDING

By pressing the "Set Node Guarding" button from the Main Window for SW67002 (Fig. 4) the right window appears (Fig. 14).

- In the field "**Node ID**" insert the address of the device that you want to control. It is possible to insert up to 32 address;
- In the field "**Guard Time**" insert a time. This value indicates the delay between two interrogation;
- In the field "**Life Time Factor**" insert the number of attempts before considering the device absent;
- In the field "**Mnemonic**" a description is defined.

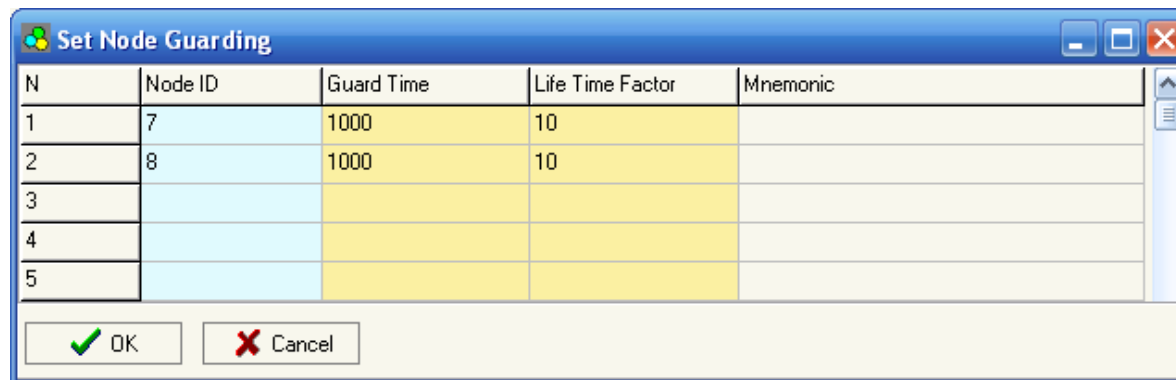

Figure 14: "Set Node Guarding" window

**UPDATE DEVICE:**

Section "Update Device":

Insert the boot jumper (see figure 2).

In order to load the parameters after they are set, set the Com port you used for update, then you must click the button "Execute update firmware" on the principal window.

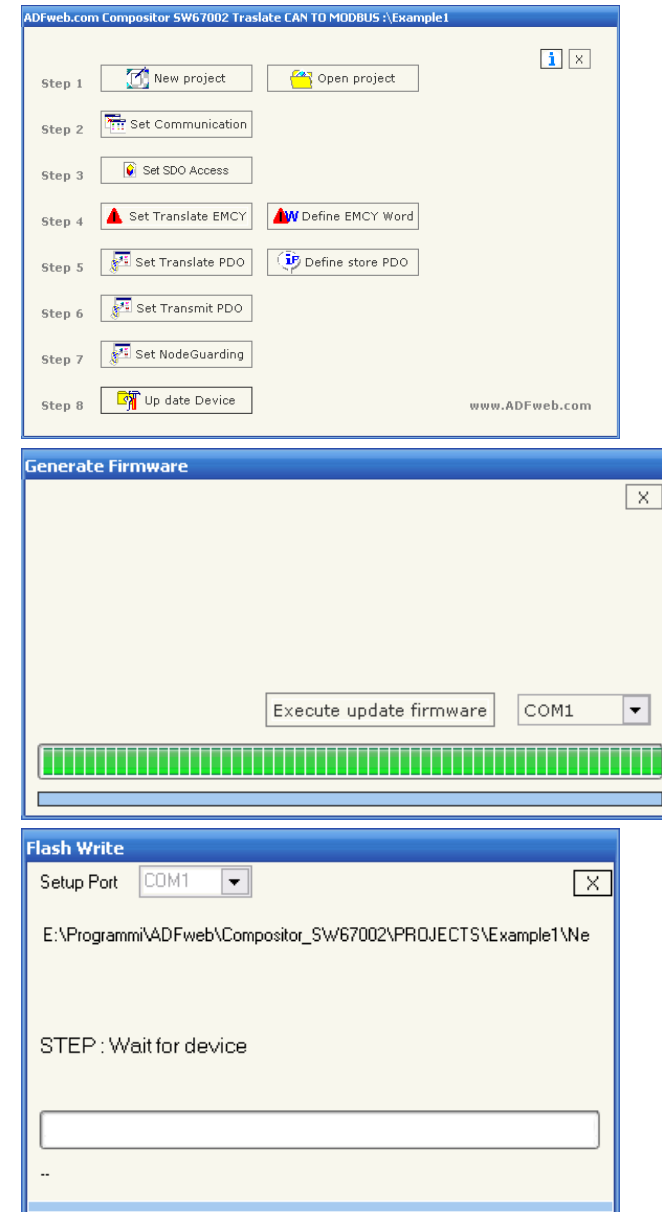

Figure 15: Update device procedure

**CHARACTERISTICS OF THE CABLES:**

The connection from RS232 socket to a serial port (example one from a personal computer) must be made with a Null Modem cable (a serial cable where the pins 2 and 3 are crossed).

It is recommended that the RS232 Cable not exceed 15 meters.

The connection at RS485 socket must be done with twisted and shielded cable.

The terminal resistor must be inserted when the HD67102 is at the end of the line, using the Terminator jumper.

Can bus cable characteristics:

<b>DC parameter:</b>	Impedance	70 Ohm/m
<b>AC parameters:</b>	Impedance	120 Ohm/m
	delay	5 ns/m
<b>Length</b>	<b>Baud Rate [bps]</b>	<b>Length MAX [m]</b>
	10 K	5000
	20 K	2500
	50 K	1000
	100 K	650
	125 K	500
	250 K	250
	500 K	100
	800 K	50
	1000 K	25

**MECHANICAL DIMENSIONS:**

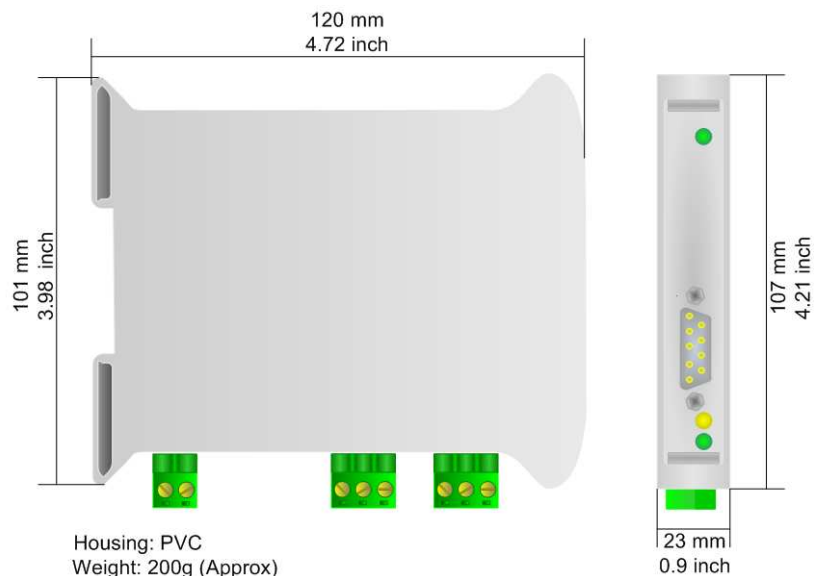

Figure 16: Mechanical dimensions scheme for HD67002

**ORDER CODES:**

Order Code: **HD67002** - CANopen / Modbus Slave – Converter (CAN connector: Terminal block)

**ACCESSORIES:**

Order Code: **AC34107** - Null Modem Cable Fem/Fem DSub 9 Pin 1,5 m

Order Code: **AC34114** - Null Modem Cable Fem/Fem DSub 9 Pin 5 m

Order Code: **AC34001** - Rail DIN - Power Supply 220/240V AC 50/60Hz – 12 V AC

Order Code: **AC34002** - Rail DIN - Power Supply 110V AC 50/60Hz – 12 V AC

## DISCLAIMER

All technical content within this document can be modified without notice. The content of the document content is a recurring audit. For losses due to fire, earthquake, third party access or other accidents, or intentional or accidental abuse, misuse, or use under abnormal conditions repairs are charged to the user. ADFweb.com S.r.l. will not be liable for accidental loss of use or inability to use this product, such as loss of business income. ADFweb.com S.r.l. shall not be liable for consequences of improper use.

## OTHER REGULATIONS AND STANDARDS

### WEEE INFORMATION



Disposal of old electrical and electronic equipment (as in the European Union and other European countries with separate collection systems).

This symbol on the product or on its packaging indicates that this product may not be treated as household rubbish. Instead, it should be taken to an applicable collection point for the recycling of electrical and electronic equipment. If the product is disposed correctly, you will help prevent potential negative environmental factors and human health, which could otherwise be caused by inappropriate disposal. The recycling of materials will help to conserve natural resources. For more information about recycling this product, please contact your local city office, your household waste disposal service or the shop where you purchased the product.

### RESTRICTION OF HAZARDOUS SUBSTANCES DIRECTIVE



The device respects the 2002/95/EC Directive on the restriction of the use of certain hazardous substances in electrical and electronic equipment (commonly referred to as Restriction of Hazardous Substances Directive or RoHS).

### CE MARKING



The product conforms with the essential requirements of the applicable EC directives.

**WARRANTIES AND TECHNICAL SUPPORT:**

For fast and easy technical support for your ADFweb.com SRL products, consult our internet support at [www.adfweb.com](http://www.adfweb.com). Otherwise contact us at the address support@adfweb.com

**RETURN POLICY:**

If while using your product you have any problem and you wish to exchange or repair it, please do the following:

- 1) Obtain a Product Return Number (PRN) from our internet support at [www.adfweb.com](http://www.adfweb.com). Together with the request, you need to provide detailed information about the problem.
- 2) Send the product to the address provided with the PRN, having prepaid the shipping costs (shipment costs billed to us will not be accepted).

If the product is within the warranty of twelve months, it will be repaired or exchanged and returned within three weeks. If the product is no longer under warranty, you will receive a repair estimate.

**PRODUCTS AND RELATED DOCUMENTS:**

Part	Description	URL
HD67121	Gateway CANopen / Canopen	<a href="http://www.adfweb.com?product=HD67121">www.adfweb.com?product=HD67121</a>
HD67001	Gateway CANopen / Modbus – RTU Master	<a href="http://www.adfweb.com?product=HD67001">www.adfweb.com?product=HD67001</a>
HD67505	Gateway CANopen / Modbus – Ethernet TCP	<a href="http://www.adfweb.com?product=HD67505">www.adfweb.com?product=HD67505</a>
HD67134	Gateway CANopen / DeviceNet	<a href="http://www.adfweb.com?product=HD67134">www.adfweb.com?product=HD67134</a>
HD67117	CAN bus Repeater	<a href="http://www.adfweb.com?product=HD67117">www.adfweb.com?product=HD67117</a>
HD67216	CAN bus Analyzer	<a href="http://www.adfweb.com?product=HD67216">www.adfweb.com?product=HD67216</a>