

User Manual

Revision 1.000
English

DALI / Modbus TCP Master - Converter

(Order Code: HD67844-B2-Y, HD67844-B2-N)

Benefits and Main Features:

Very

- ✚
- ✚ Electrical isolation
- ✚ Temperature range: -40°C/85°C (-40°F/185°F)

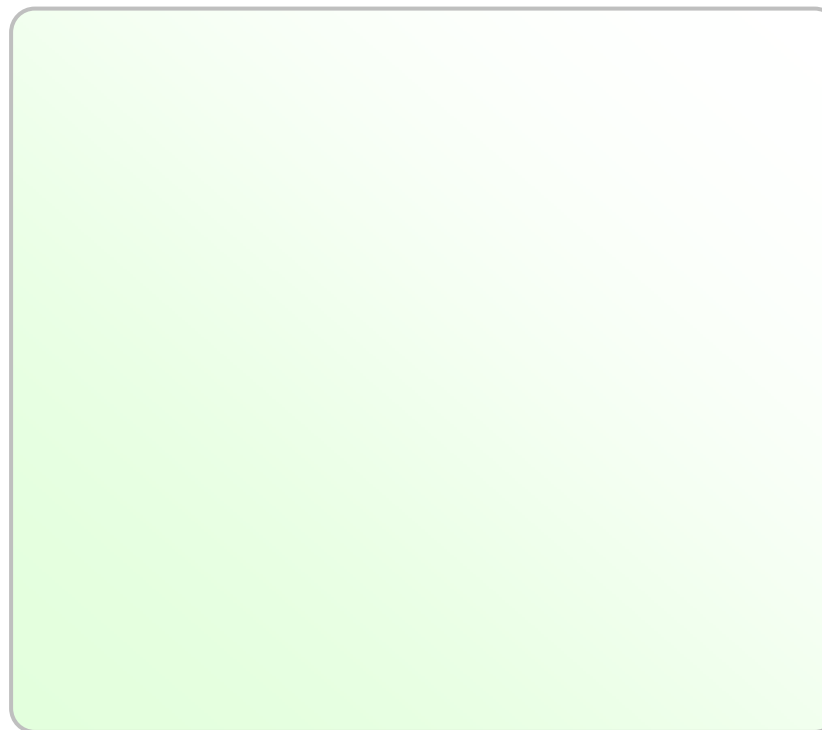

INDEX:

	Page
INDEX	2
UPDATED DOCUMENTATION	2
REVISION LIST	2
WARNING	2
TRADEMARKS	2
SECURITY ALERT	3
EXAMPLE OF CONNECTION	4
CONNECTION SCHEME	5
CHARACTERISTICS	6
CONFIGURATION	6
POWER SUPPLY	7
FUNCTION MODES	8
LEDS	9
DALI	10
ETHERNET	11
USE OF COMPOSITOR SW67844	12
NEW PROJECT / OPEN PROJECT	13
SOFTWARE OPTIONS	14
SET COMMUNICATION	16
DALI ACCESS	17
SET ACCESS	18
UPDATE DEVICE	20
USE OF DALI CONSOLE SOFTWARE	22
STRUCTURE OF THE SOFTWARE	23
SETUP	24
NETWORK SETTING	25
DATA MAPPING	30
MECHANICAL DIMENSIONS	40
ORDERING INFORMATIONS	41
ACCESSORIES	41
DISCLAIMER	42
OTHER REGULATIONS AND STANDARDS	42
WARRANTIES AND TECHNICAL SUPPORT	43
RETURN POLICY	43

UPDATED DOCUMENTATION:

Dear customer, we thank you for your attention and we remind you that you need to check that the following document is:

- ✚ Updated
- ✚ Related to the product you own

To obtain the most recently updated document, note the “document code” that appears at the top right-hand corner of each page of this document.

With this “Document Code” go to web page www.adfweb.com/download/ and search for the corresponding code on the page. Click on the proper “Document Code” and download the updates.

REVISION LIST:

Revision	Date	Author	Chapter	Description
1.000	05/04/2017	Ff	All	First Release

WARNING:

ADFweb.com reserves the right to change information in this manual about our product without warning.
ADFweb.com is not responsible for any error this manual may contain.

TRADEMARKS:

All trademarks mentioned in this document belong to their respective owners.

SECURITY ALERT:**GENERAL INFORMATION**

To ensure safe operation, the device must be operated according to the instructions in the manual. When using the device, legal and safety regulation are required for each individual application. The same applies also when using accessories.

INTENDED USE

Machines and systems must be designed so the faulty conditions do not lead to a dangerous situation for the operator (i.e. independent limit switches, mechanical interlocks, etc.).

QUALIFIED PERSONNEL

The device can be used only by qualified personnel, strictly in accordance with the specifications.

Qualified personnel are persons who are familiar with the installation, assembly, commissioning and operation of this equipment and who have appropriate qualifications for their job.

RESIDUAL RISKS

The device is state-of-the-art and is safe. The instruments can represent a potential hazard if they are inappropriately installed and operated by untrained personnel. These instructions refer to residual risks with the following symbol:



This symbol indicates that non-observance of the safety instructions is a danger for people that could lead to serious injury or death and / or the possibility of damage.

CE CONFORMITY

The declaration is made by our company. You can send an email to or give us a call if you need it.

EXAMPLE OF CONNECTION:

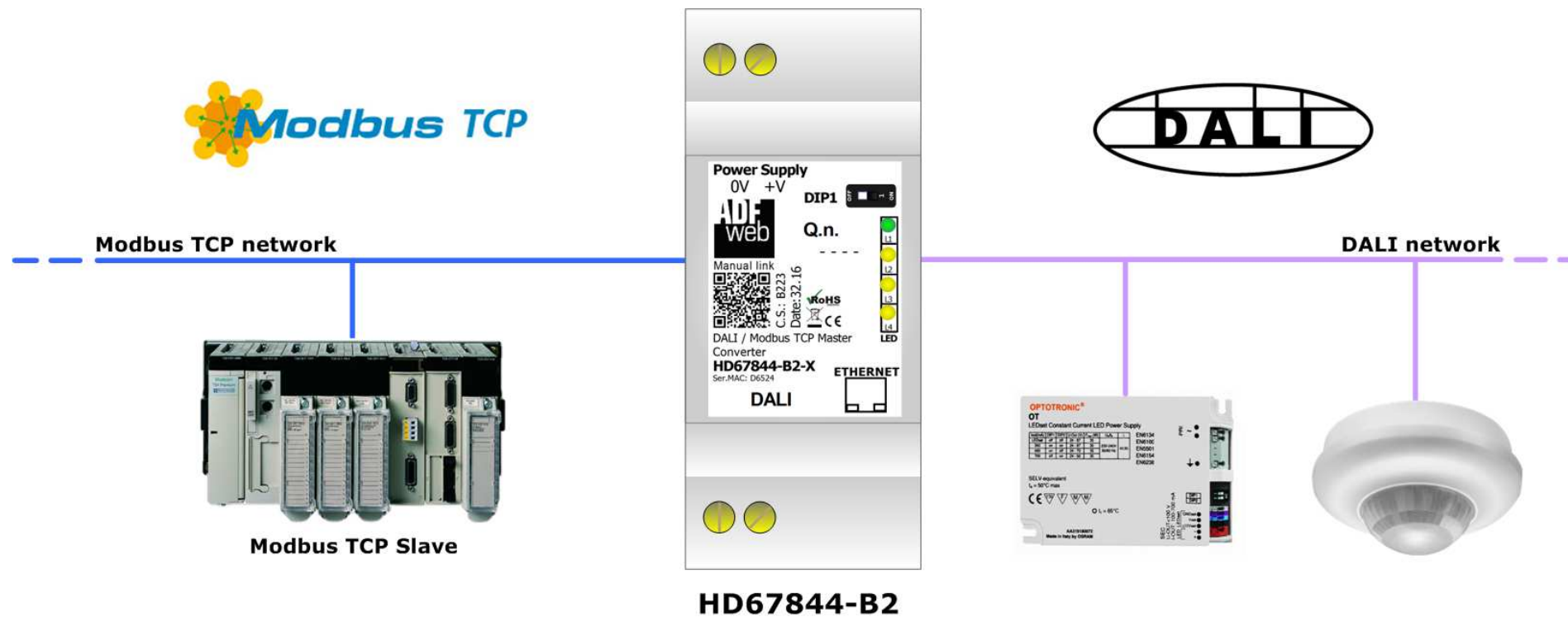

CONNECTION SCHEME:

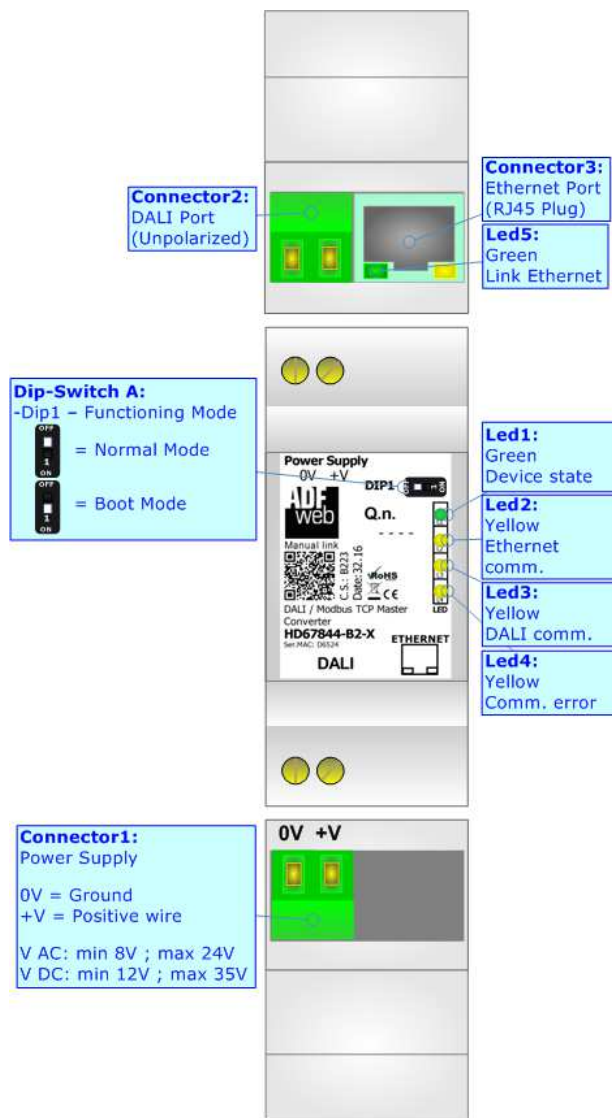

Figure 1: Connection scheme for HD67844-B2

CHARACTERISTICS:

The HD67844 is a DALI / Modbus TCP Master - Converter.

It has the following characteristics:

- Up to 64 devices on DALI bus;
- Configurator for DALI network/devices;
- Isolation between DALI – Ethernet, Power Supply - Ethernet. Additional isolation Power Supply – DALI for HD67844-B2-N version;
- Two-directional information between DALI bus and Modbus TCP bus;
- Mountable on 35mm Rail DIN;
- Wide power supply input range: 8...24V AC or 12...35V DC;
- Wide temperature range: -40°C / 85°C [-40°F / +185°F].

CONFIGURATION:

You need “DALI Console” software on your PC in order to perform the following:



- Configure the DALI network;
- Setup the DALI devices (groups, scenes, IDs, ...);
- Test DALI communication.

You need Compositor SW67844 software on your PC in order to perform the following:

- Define the parameter of Modbus TCP line;
- Define the parameter of DALI line;
- Update the device.

POWER SUPPLY:

The devices can be powered at 8...24V AC and 12...35V DC. For more details see the two tables below.

VAC 		VDC 	
Vmin	Vmax	Vmin	Vmax
8V	24V	12V	35V

Consumption at 24V DC:

Device	Consumption [W/VA]
HD67844-B2	3.5

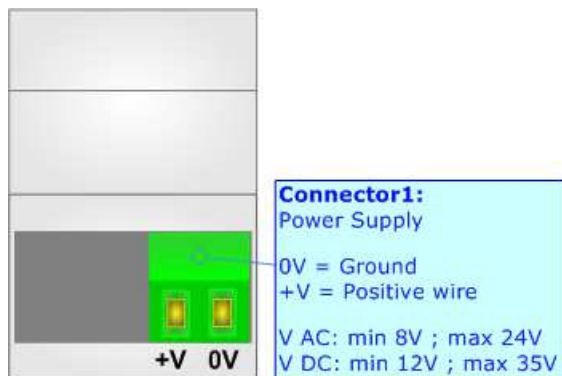

Caution: Not reverse the polarity power

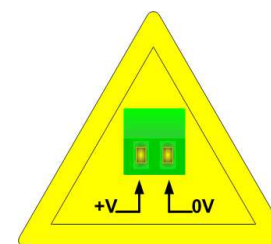

HD67844-B2

FUNCTION MODES:

The device has got two functions mode depending of the position of the 'Dip1 of Dip-Switch A':

- The first, with 'Dip1 of Dip-Switch A' at "OFF" position, is used for the normal working of the device.
- The second, with 'Dip1 of Dip-Switch A' at "ON" position, is used for upload the Project and/or Firmware.

For the operations to follow for the updating, see 'UPDATE DEVICE' section.

According to the functioning mode, the LEDs will have specifics functions, see 'LEDS' section.

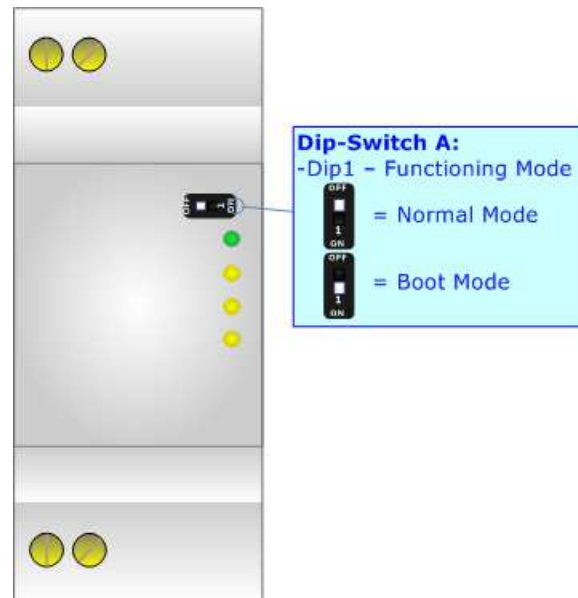

LEDS:

The device has got five LEDs that are used to give information of the functioning status. The various meanings of the LEDs are described in the table below.

LED	Normal Mode	Boot Mode
1: Device State (green)	Blinks slowly (~1Hz)	Blinks quickly: Boot state Blinks very slowly (~0.5Hz): update in progress
2: Ethernet communication (yellow)	Blinks when Ethernet communication is running	Blinks quickly: Boot state Blinks very slowly (~0.5Hz): update in progress
3: DALI communication (yellow)	Blinks when DALI communication is running	Blinks quickly: Boot state Blinks very slowly (~0.5Hz): update in progress
4: Comm. error (yellow)	Turns ON when DALI or Modbus TCP is in error	Blinks quickly: Boot state Blinks very slowly (~0.5Hz): update in progress
5: Ethernet Link (green)	ON: Ethernet cable connected OFF: Ethernet cable disconnected	ON: Ethernet cable connected OFF: Ethernet cable disconnected

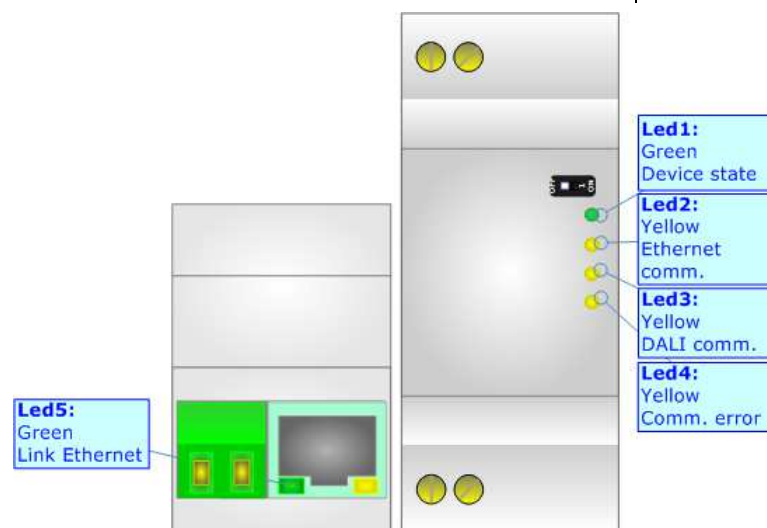

DALI:

DALI stands for “Digital Addressable Lighting Interface” and it is an interface protocol for digital communication between electronic lighting equipment (electronic ballasts, transformers, etc.). With the right choice of individual DALI components an extremely wide range of requirements can be met, from operating the lighting system from a simple light switch to lighting management systems for entire office complexes with thousands of light sources. Using ADFweb.com’s DALI converters, any light source, including incandescent lamps, fluorescent lamps, high-intensity discharge lamps and even LEDs, can be controlled irrespective of whether they are installed in an office, a restaurant or a street light.

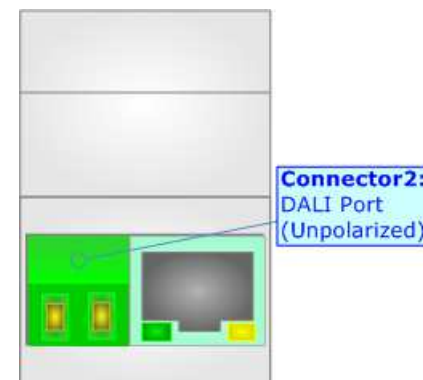

Characteristics	Description
Medium	Shielded Twisted Pair
Topology	Linear, Star or mixed
Device power consumption	Max 250 mA
DALI voltage	9.5 V – 22.5 V (typical 16 V)
Maximum cable length	300 m (1.5 mm ² wire)
Maximum number of DALI devices	64
Baud rate	1200 bps
Maximum number of DALI groups	16
Maximum number of DALI scenes	16

ETHERNET:

The Ethernet port is used for the Modbus TCP communication, for programming DALI network and for programming the device.

The Ethernet connection must be made using Connector2 of HD67844-B2 with at least a Category 5E cable. The maximum length of the cable should not exceed 100m. The cable has to conform to the T568 norms relative to connections in cat.5 up to 100 Mbps. To connect the device to an Hub/Switch is recommended the use of a straight cable, to connect the device to a PC is recommended the use of a cross cable.

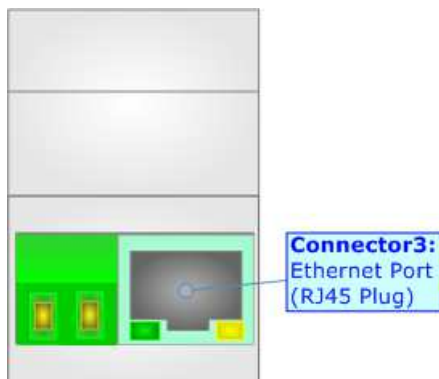

USE OF COMPOSITOR SW67844:

To configure the Converter, use the available software that runs with Windows called SW67844. It is downloadable on the site www.adfweb.com and its operation is described in this document. *(This manual is referenced to the last version of the software present on our web site).* The software works with MSWindows (XP, Vista, Seven, 8, 10; 32/64bit).

When launching the SW67844, the window below appears (Fig. 2).

**Note:**

It is necessary to have installed .Net Framework 4.

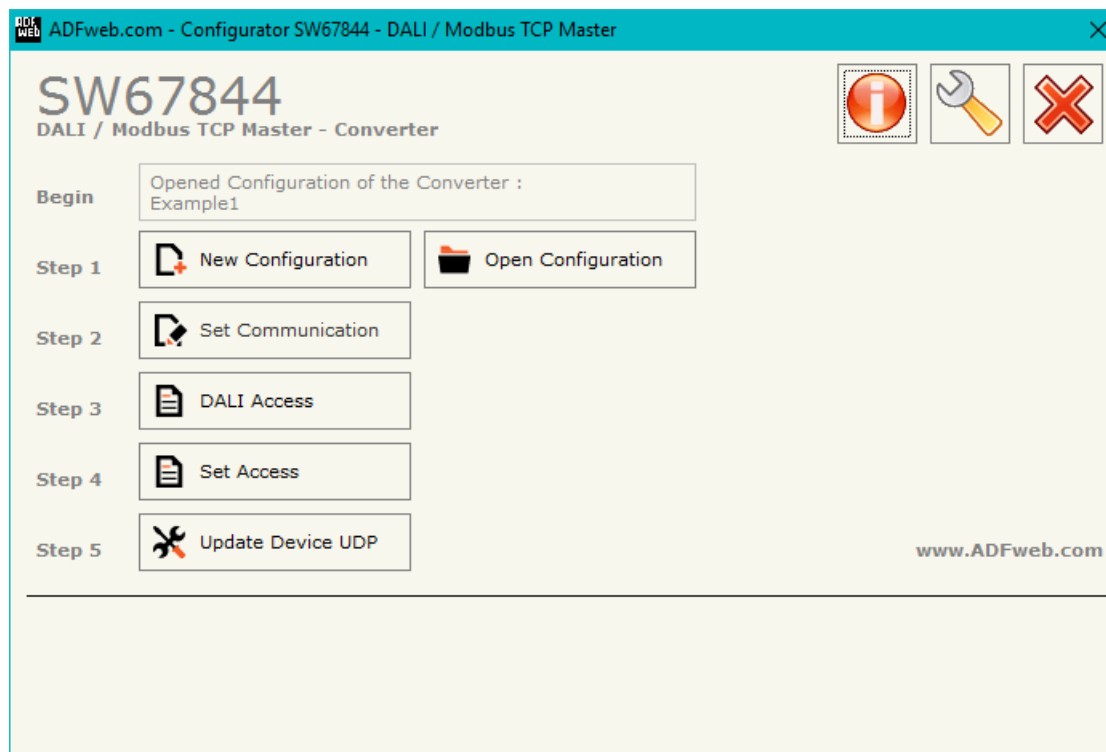
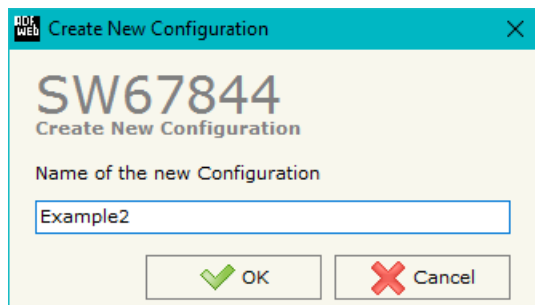

Figure 2: Main window for SW67844

NEW CONFIGURATION / OPEN CONFIGURATION:

The “**New Configuration**” button creates the folder which contains the entire device’s configuration.



A device’s configuration can also be imported or exported:

- To clone the configurations of a Programmable “DALI / Modbus TCP Master - Converter” in order to configure another device in the same manner, it is necessary to maintain the folder and all its contents;
- To clone a project in order to obtain a different version of the project, it is sufficient to duplicate the project folder with another name and open the new folder with the button “**Open Configuration**”.

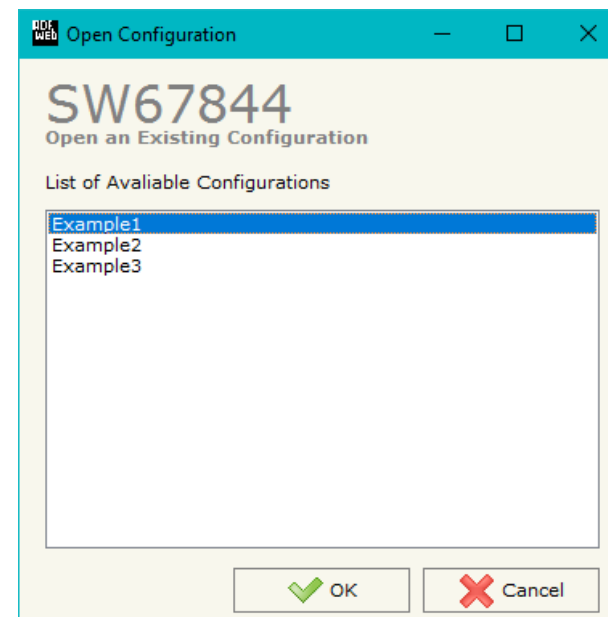

SOFTWARE OPTIONS:

By pressing the “**Settings**” () button there is the possibility to change the language of the software and check the updatings for the compositor.

In the section “Language” it is possible to change the language of the software.

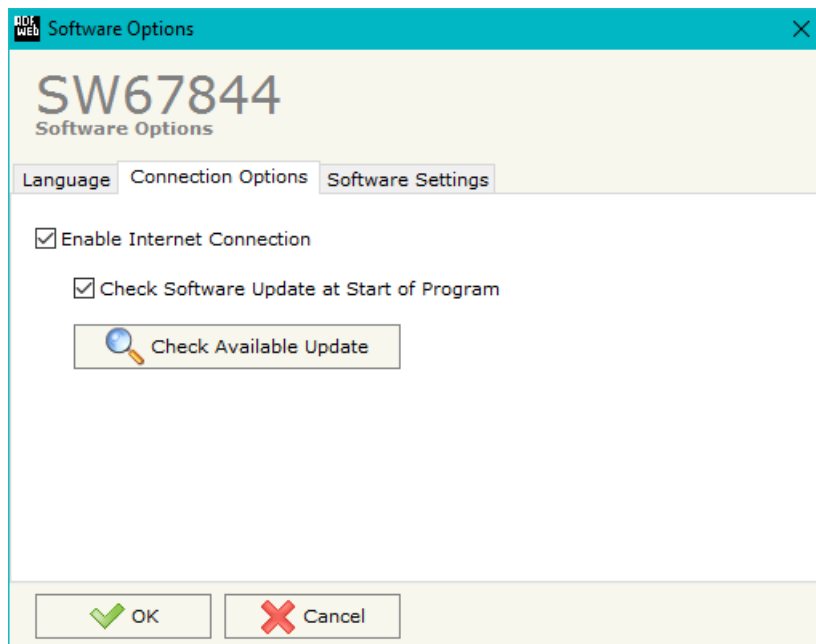

In the section “Connection Options”, it is possible to check if there are some updatings of the software compositor in ADFweb.com website. Checking the option “**Check Software Update at Start of Program**”, the SW67844 check automatically if there are updatings when it is launched.

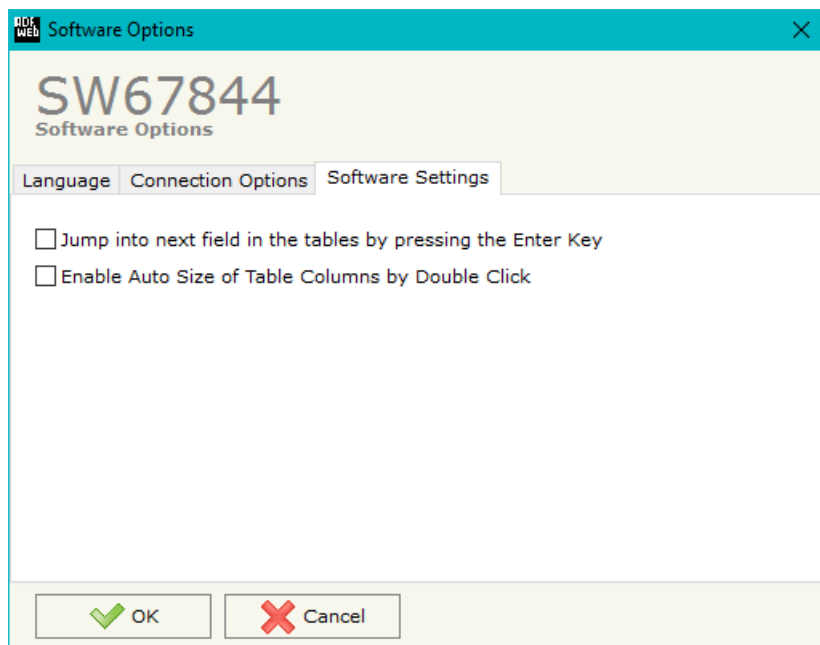

In the section "Software Settings", it is possible to enable/disable some keyboard's commands for an easier navigation inside the tables contained in the different sections of the software.

SET COMMUNICATION:

This section define the fundamental communication parameters of Modbus TCP and DALI bus.

By Pressing the "**Set Communication**" button from the main window for SW67844 (Fig. 2) the window "Set Communication" appears (Fig. 3).

The means of the fields for the "Modbus TCP Master" section are:

- In the field "**IP ADDRESS**" the IP address of the converter is defined;
- In the field "**SUBNET Mask**" the SubNet Mask is defined;
- In the field "**GATEWAY**" the default gateway of the Ethernet network is defined. This feature can be enabled or disabled pressing the Check Box field. This feature is used for going out of the net;
- In the field "**TimeOut (ms)**" the maximum time that the device attends for the answer from the Slave interrogated is defined;
- In the field "**Communication Idle Time (ms)**" the minimum delay between two polls is defined.

The means of the fields for the "DALI" section are:

- In the field "**DALI Console Port**" the UDP port used for the communication with 'DALI Console' software is defined;
- If the field "**Switch off DALI on Timeout**" is checked, the DALI line is switched OFF if there is no communication with a Modbus TCP slave for the "**TimeOut (ms)**" defined below.

The screenshot shows a software window titled "Set Communication" for device "SW67844". It is divided into two sections: "Modbus TCP Master" and "DALI".

Modbus TCP Master section:

- IP ADDRESS: 192.168.0.5
- SUBNET Mask: 255.255.255.0
- GATEWAY: 192.168.0.1 (checkbox is unchecked)
- TimeOut (ms): 1000
- Cyclic Delay (ms): 100

DALI section:

- DALI Console Port: 10001
- Switch Off DALI on TimeOut: (checkbox is unchecked)
- TimeOut (ms): 0

At the bottom, there are "OK" and "Cancel" buttons.

Figure 3: "Set Communication" window

DALI ACCESS:

By pressing the “**DALI Access**” button from the main window for SW67844 (Fig. 2) the window “Select the DALI Device Present in the Network” appears (Fig. 4).

This section is used to define the DALI devices connected to the converter. It is enough to check/uncheck the connected/unconnected DALI devices.

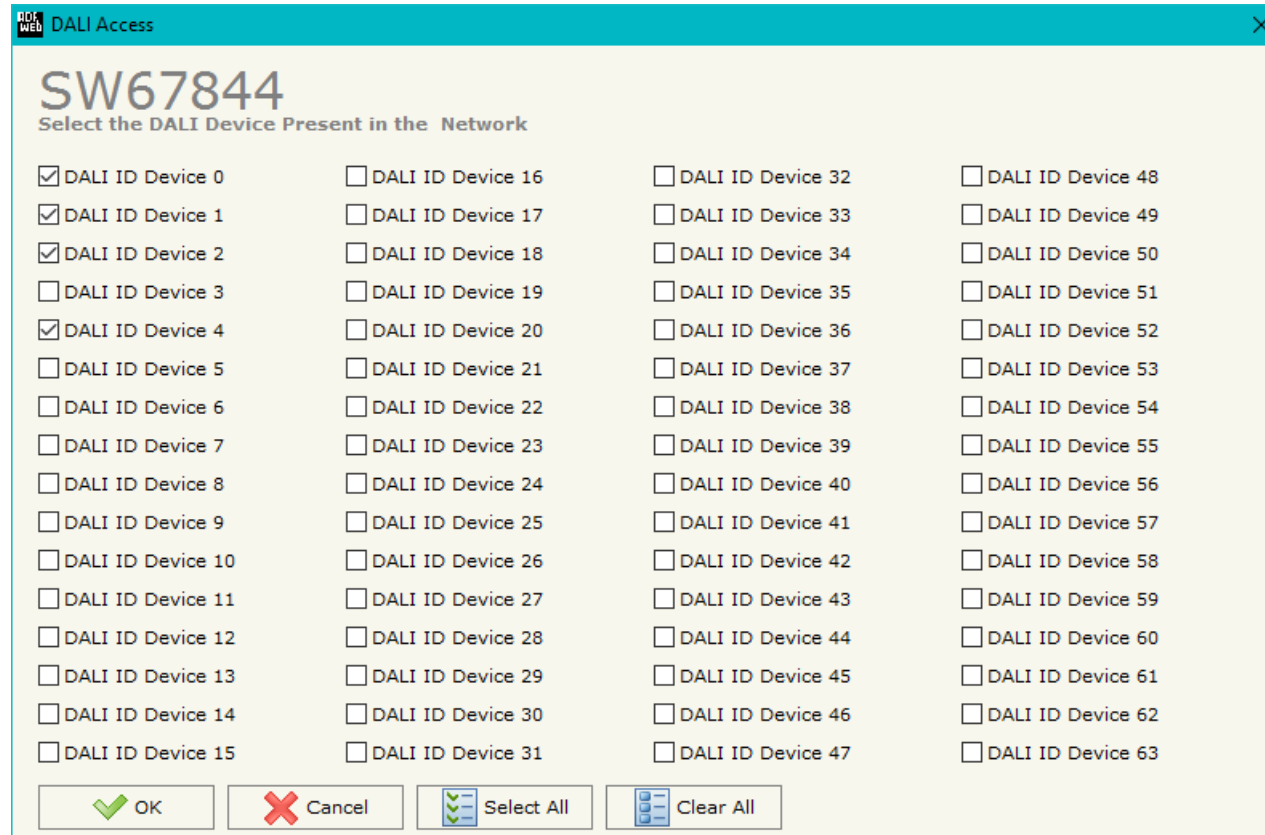

Figure 4: "DALI Access" window

SET ACCESS:

By pressing the "Set Access" button from the main window for SW67844 (Fig. 2) the window "Set Access" appears.

This window is divided in two parts, the "Modbus Read" and the "Modbus Write".

The first part "Modbus Read" is used to read the data from the Modbus TCP slaves and make them available on DALI network.

The second part "Modbus Write" is used to write the data that arrives from the DALI system into the Modbus TCP slaves.

The means of the fields are:

- If the field "Enable" is checked, the Modbus Request is enabled;
- In the field "Slave IP Address" the IP Address of the Modbus TCP device to read/write is defined;
- In the field "Port" the TCP port of the Modbus TCP device to read/write is defined;
- In the field "Slave ID" the address of the Modbus device to read/write is defined;
- In the field "Type" the data type of the register to read is defined. It is possible to choose between the following:
 - Coil Status;
 - Input Status;
 - Holding Register;
 - Input Register.
- In the field "Address" the starting address of the register to be read/written is defined;
- In the field "NPoint" the number of consecutive registers to be read/written is defined;
- In the field "Poll Time" the delay time to make this request is defined;
- In the field "Max Error" the number of consecutive errors that the converter waits before suspending the poll until the next reboot is defined. If it is set to '0', this function is disabled;
- In the field "Position" the address of the internal array where placing/taking the informations is defined;

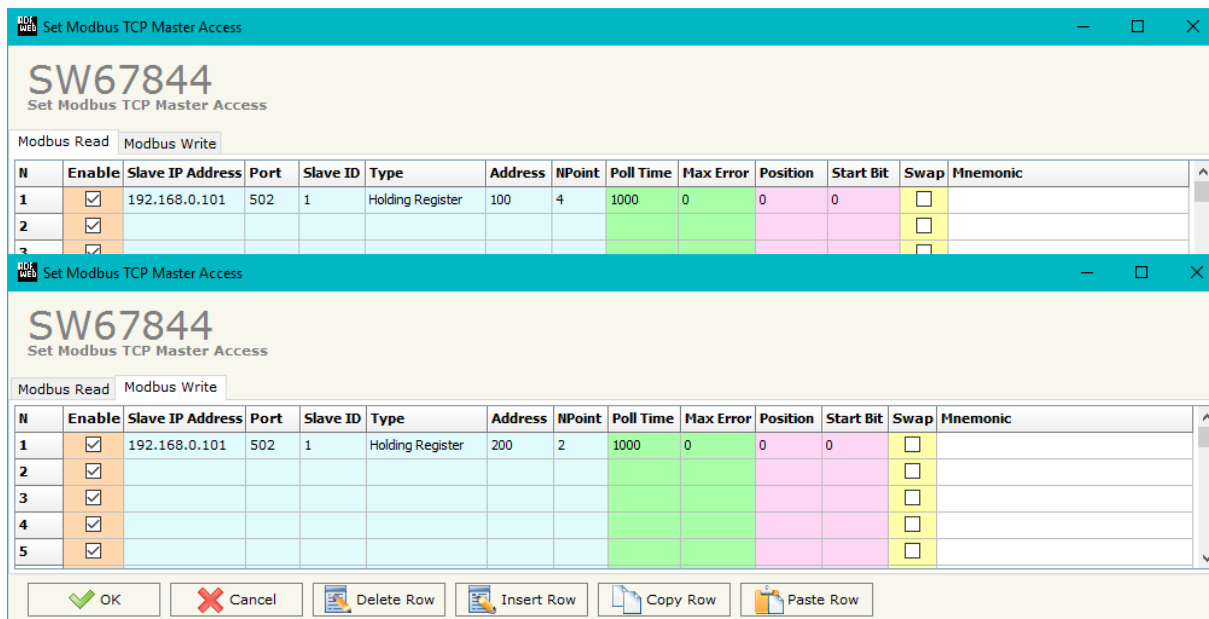

Figure 5: "Set Modbus TCP Master Access" window

- ✦ In the field "**Start Bit**" the starting bit of the first "Position" selected where mapping/taking the data read is defined. Valid only for the "Coil Status" and "Input Status";
- ✦ If the field "**Swap**" is checked, the bytes of the Modbus registers are swapped;
- ✦ In the field "**Mnemonic**" the description for the request is defined.

UPDATE DEVICE:

By pressing the **"Update Device"** button, it is possible to load the created Configuration into the device; and also the Firmware, if necessary.

If you don't know the actual IP address of the device you have to use this procedure:

- Turn OFF the Device;
- Put Dip1 of 'Dip-Switch A' in ON position;
- Turn ON the device
- Connect the Ethernet cable;
- Insert the IP **"192.168.2.205"**;
- Select which operations you want to do;
- Press the **"Execute update firmware"** button to start the upload;
- When all the operations are "OK", close the windows;
- Put Dip1 of 'Dip-Switch A' at OFF position.

If you know the actual IP address of the device, you have to use this procedure:

- Turn ON the Device with the Ethernet cable inserted;
- Insert the actual IP of the Converter;
- Select which operations you want to do;
- Press the **"Execute update firmware"** button to start the upload;
- When all the operations are "OK", the device automatically goes at Normal Mode.

At this point the configuration/firmware on the device is correctly update.

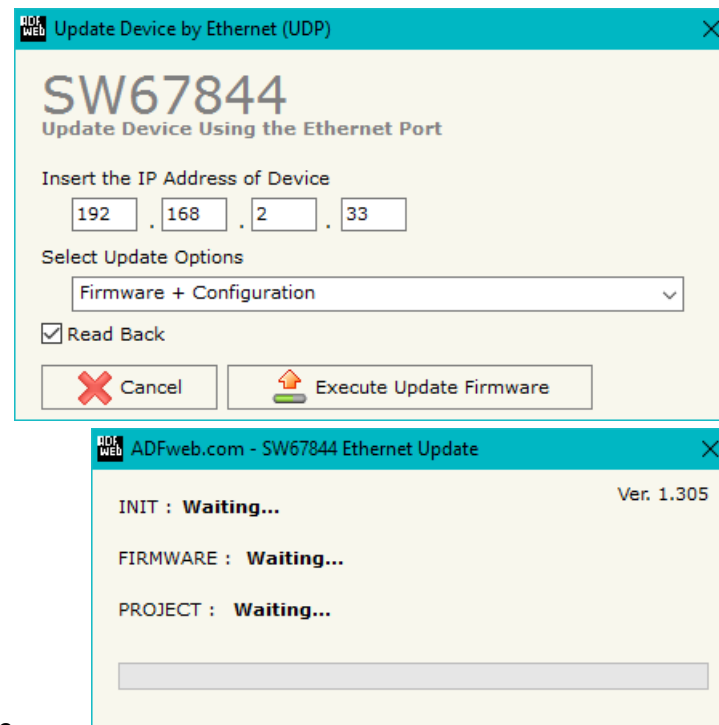

Figure 6: "Update device" windows

**Note:**

When you install a new version of the software, if it is the first time it is better you do the update of the Firmware in the HD67844 device.

**Note:**

When you receive the device, for the first time, you also have to update the Firmware in the HD67844 device.

**Warning:**

If Fig. 7 appears when you try to do the Update try these points before seeking assistance:

- Try to repeat the operations for the updating;
- Try with another PC;
- Try to restart the PC;
- Check the LAN settings;
- Check the Wi-Fi settings;
- If you are using the program inside a Virtual Machine, try to use in the main Operating System;
- If you are using Windows Seven, Vista, 8 or 10 make sure that you have the administrator privileges;
- In case you have to program more than one device, using the "UDP Update", you have to cancel the ARP table every time you connect a new device on Ethernet. For do this you have to launch the "Command Prompt" and write the command "arp -d". Pay attention that with Windows Vista, Seven, 8, 10 you have to launch the "Command Prompt" with Administrator Rights;
- Pay attention at Firewall lock.

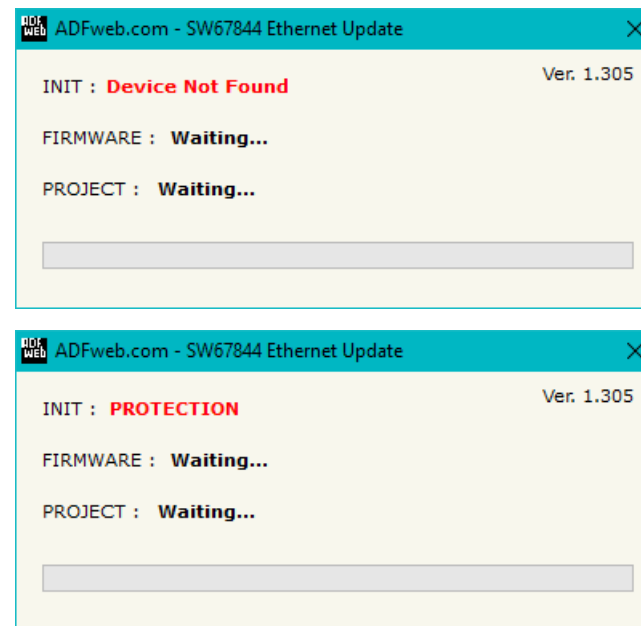

Figure 7: "Protection" window



In the case of HD67844 you have to use the software "SW67844": www.adfweb.com/download/filefold/SW67844.zip.

USE OF DALI CONSOLE SOFTWARE:

To configure DALI network and test the communication, it is possible to use the available software that runs with Windows called "DALI Console". It is downloadable on the site www.adfweb.com and its operation is described in this document. *(This manual is referenced to the last version of the software present on our web site).* The software works with MSWindows (XP, Vista, Seven, 8, 10; 32/64bit).

When launching the DALI Console, the window below appears (Fig. 8).

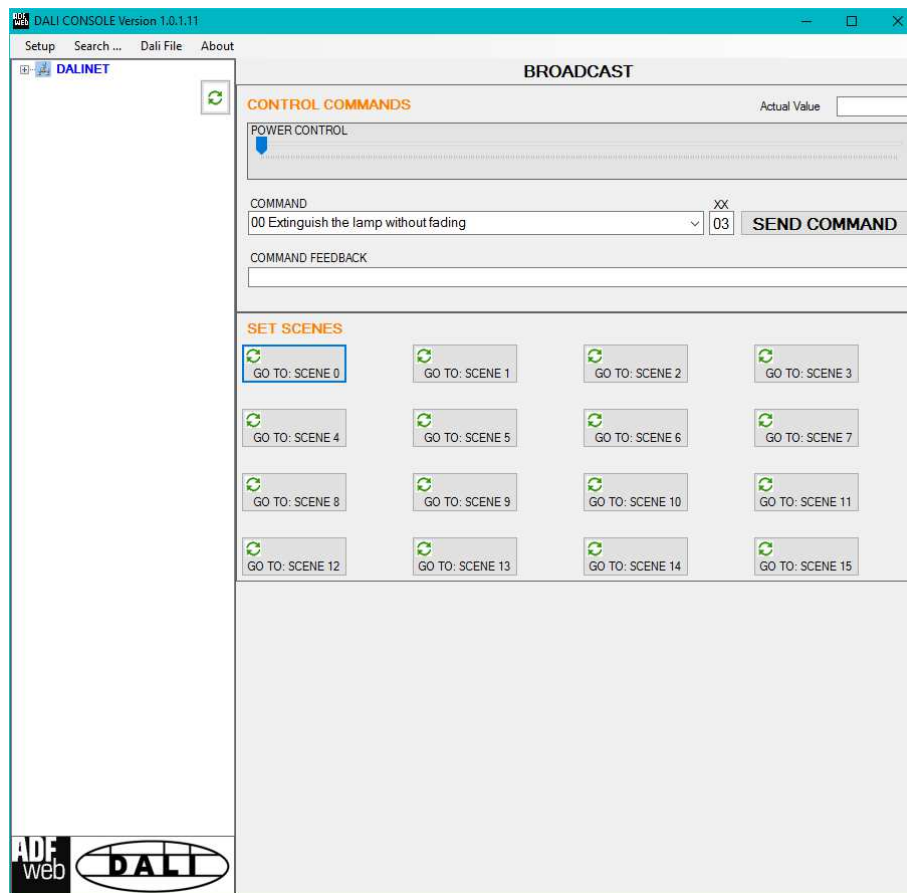
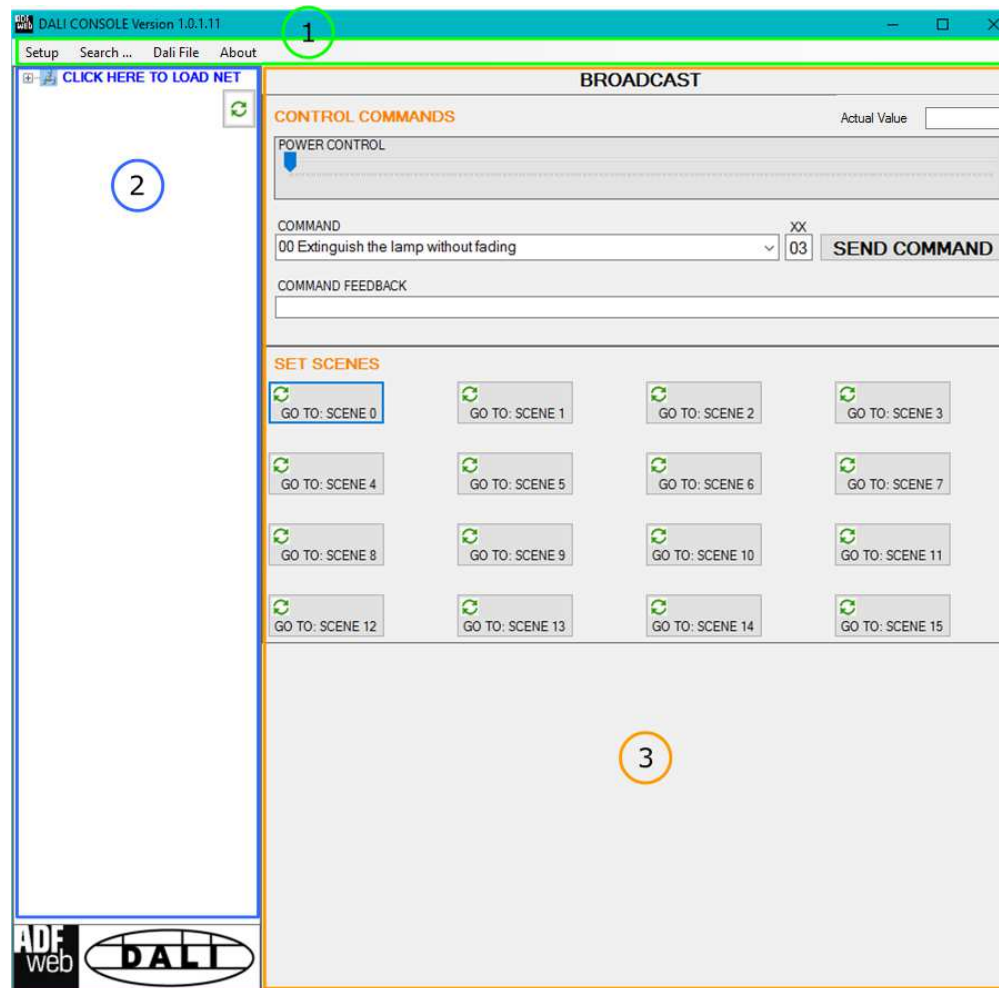

Figure 8: Main window for DALI Console

STRUCTURE OF THE SOFTWARE:

The software layout is very simple and it is structured in this way:

- **"Menu bar"** (Fig. 9, Point 1): it is possible to open the setup window ("Setup" menu), scan the DALI network and program automatically the IDs ("Search..." menu), export/import the results of the communication ("Dali File" menu) and see the informations about the DALI Console software ("About" menu).
- **"Network view"** (Fig. 9, Point 2): it is possible to see all the DALI devices connected to the HD67844 converter, the groups and the scenes set;
- **"Settings / commands view"** (Fig. 9, Point 3): it is possible to set and manage the parameters to the single DALI device, to the groups or for the full network.



(1) Menu bar

(2) Network view

(3) Settings / commands view

Figure 9: Structure of DALI Console software

SETUP:

This section defines the connection's parameters to the Ethernet side of the HD67844 converter.

By Pressing the "Setup" button from the menu bar of the DALI Console software, the "SETUP" window appears (Fig. x).

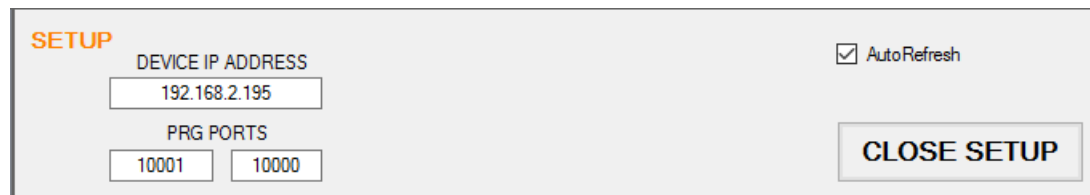

Figure 10: "Setup" window

The means of the fields for the "SETUP" window are:

- In the field "**DEVICE IP ADDRESS**" the IP address set inside the converter is defined;
- In the field "**PRG PORT**" the communication ports used for the Ethernet communication with the converter is defined: the one on the left must be equal to the DALI Port programmed with SW67844, the one on the right must be fixed to '10000'.

NETWORK SETTING:

By pressing the button in the Network view, it is possible to scan the full DALI network and find all the DALI devices, the groups set and the scenes configured.

By selecting the single DALI devices found, the single groups, the single scene or the entire DALI network, it is possible to manage and test the functioning of the network.

DEVICES:

The means of the fields for "DEVICE INFO" are:

- In the field "**Device Type**" the type of DALI device is printed;
- In the field "**Software version**" the software version of the DALI device is printed;
- In the fields "**Power Range**" Min value, Actual value, Max value, System Fail value, Power On value, Fade Time and Fade Rate of the DALI device is defined. It is possible to read the actual value and set a new value;
- In the fields "**DEVICE STATUS**" the actual status of the DALI device is printed;
- In the field "**SET NEW ADDRESS**" it is possible to program a new ID to the DALI node;
- In the field "**REMOVE ADDRESS**" it is possible to delete the ID from the DALI node.

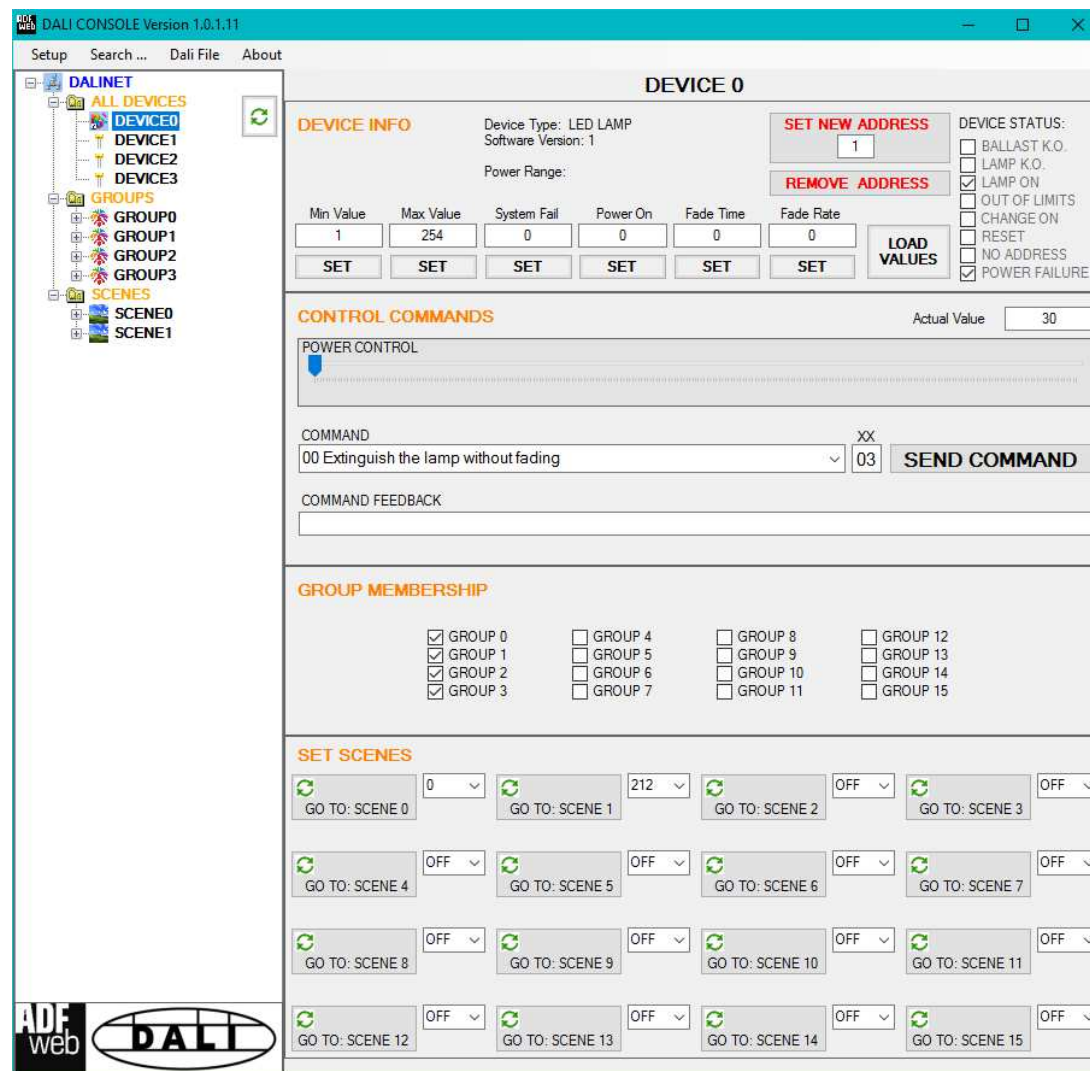

Figure 11: "Device settings" window

The means of the fields for the "CONTROL COMMANDS" section are:

- In the "**POWER CONTROL**" bar it is possible to change the actual ADV of the selected DALI device;
- In the field "**COMMAND**" it is possible to select a DALI command to send to the selected DALI device. For set commands, it is possible to insert the value to set in the field "**xx**". As soon as the command to send is selected, the command is sent: in order to send the same command more times, it is possible to press the "**SEND COMMAND**" button;
- In the field "**COMMAND FEEDBACK**" the response from the DALI device is printed.



Note:

This section is used to test the functioning of the DALI device in the network and to set specific parameters if needed (like new Minimum or Maximum ADV value).

In the "GROUP MEMBERSHIP" section it is possible to see the Groups which the selected DALI device is in. The checked checkboxes mean that the device is in the correspondent groups, the unchecked checkboxes mean that the device is not included in the correspondent groups. It is possible to change the group settings for the selected DALI device by checking/unchecking the correspondent checkboxes.

In the "SET SCENES" section it is possible to see the programmed scenes of the selected DALI device, program new ones and activate them:

- By pressing the buttons "**GO TO: SCENE X**" it is possible to activate the correspondent scene inside the selected DALI device; the programmed ADV for the selected scene is defined in the drop-down list on the right;
- By selecting a value into the drop-down lists next to the "GO TO: SCENE x" buttons, it is possible to set the ADV associated to the correspondent scene. It is possible to select:
 - Value between 0 and 255: the scene will have the defined value of ADV;
 - ACT: the scene will take the programmed ADV value into the "POWER CONTROL" bar;
 - OFF: the scene is disabled.

GROUPS:

The means of the fields for the "CONTROL COMMANDS" section are:

- In the "POWER CONTROL" bar it is possible to change the actual ADV of the selected DALI group;
- In the field "COMMAND" it is possible to select a DALI command to send to the selected DALI group. For set commands, it is possible to insert the value to set in the field "xx". As soon as the command to send is selected, the command is sent: in order to send the same command more times, it is possible to press the "SEND COMMAND" button;
- In the field "COMMAND FEEDBACK" the response from the DALI group is printed.

 **Note:** This section is used to test the functioning of the DALI groups in the network.

In the "SET SCENES" section it is possible to activate the programmed scenes to the selected group:

- By pressing the buttons "GO TO: SCENE X" it is possible to activate the correspondent scene inside the selected DALI group.

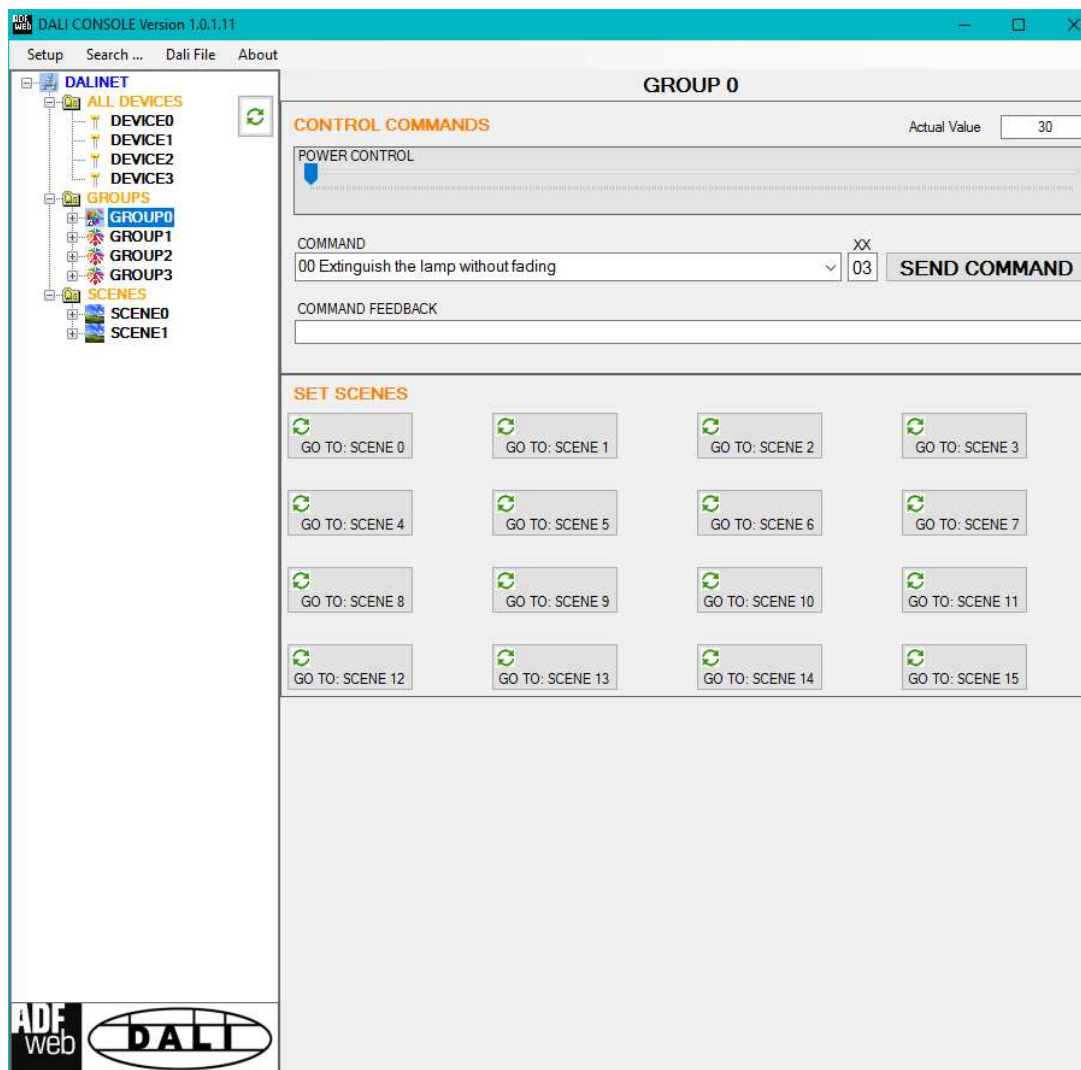

Figure 12: "Groups settings" window

ALL DEVICES (BROADCAST):

The means of the fields for the “CONTROL COMMANDS” section are:

- In the “**POWER CONTROL**” bar it is possible to change the actual ADV of the entire DALI network;
- In the field “**COMMAND**” it is possible to select a DALI command to send to the entire DALI network. For set commands, it is possible to insert the value to set in the field “**xx**”. As soon as the command to send is selected, the command is sent: in order to send the same command more times, it is possible to press the “**SEND COMMAND**” button;
- In the field “**COMMAND FEEDBACK**” the response from the DALI network is printed.



Note:

This section is used to test the functioning of the DALI network.

In the “SET SCENES” section it is possible to activate the programmed scenes into all the DALI devices that have them:

- By pressing the buttons “**GO TO: SCENE X**” it is possible to activate the correspondent scene in the DALI network. Only the devices that have it will accept the command.

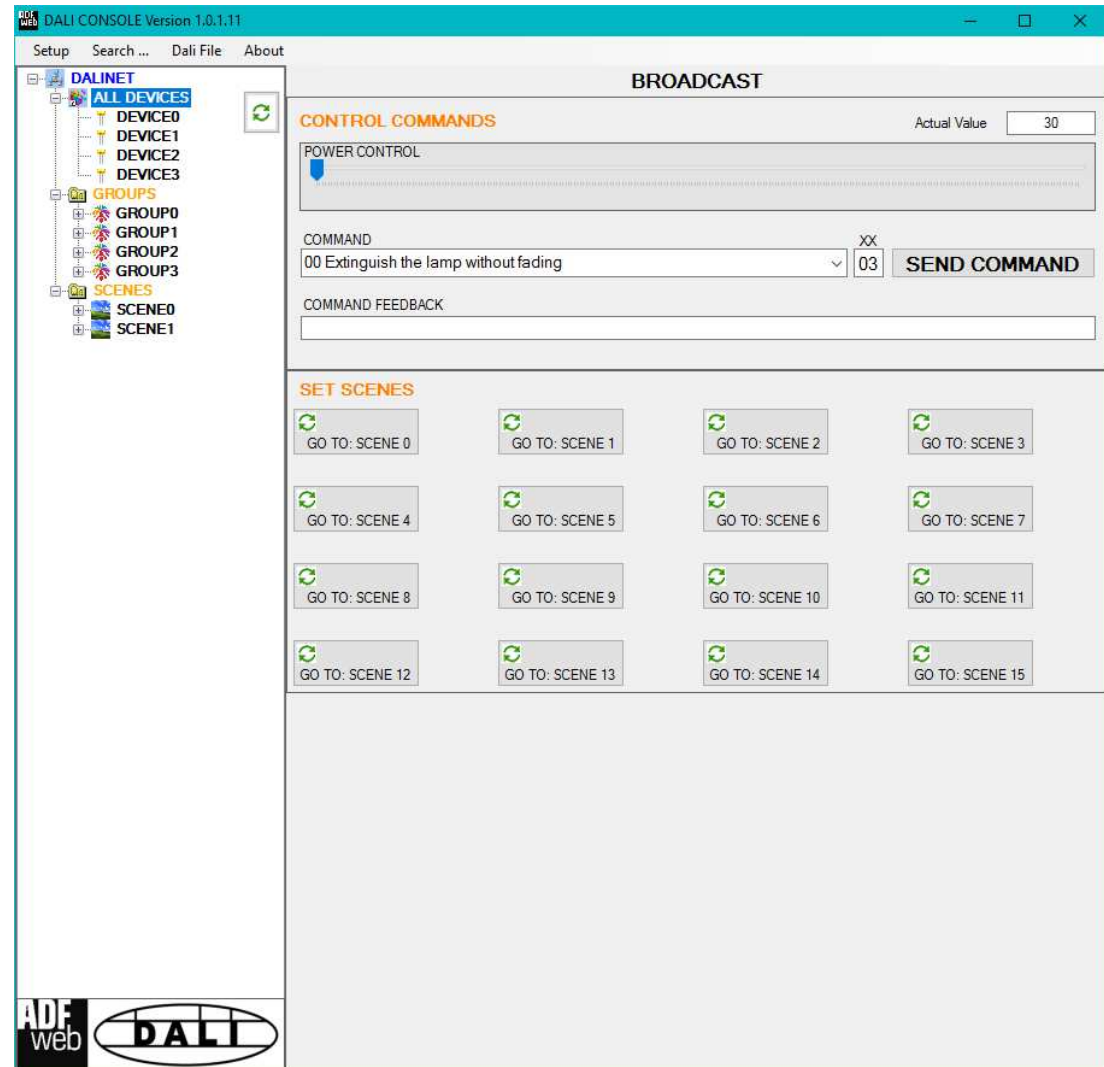

Figure 14: “Broadcast settings” window

DATA MAPPING:

Internally to the converter, there are two different arrays of bytes. The data inside them are different:

- Array in IN: data read from DALI network;
- Array in OUT: data written to DALI network.

Structure of the array in OUT (data read from DALI devices and mapped into the converter)

Position/Byte	Meaning
0-7	Informations about DALI node 0
8-15	Informations about DALI node 1
16-23	Informations about DALI node 2
24-31	Informations about DALI node 3
32-39	Informations about DALI node 4
40-47	Informations about DALI node 5
48-55	Informations about DALI node 6
56-63	Informations about DALI node 7
64-71	Informations about DALI node 8
72-79	Informations about DALI node 9
80-87	Informations about DALI node 10
88-95	Informations about DALI node 11
96-103	Informations about DALI node 12
104-111	Informations about DALI node 13
112-119	Informations about DALI node 14
120-127	Informations about DALI node 15
128-135	Informations about DALI node 16
136-143	Informations about DALI node 17
144-151	Informations about DALI node 18
152-159	Informations about DALI node 19
160-167	Informations about DALI node 20
168-175	Informations about DALI node 21
176-183	Informations about DALI node 22
184-191	Informations about DALI node 23
192-199	Informations about DALI node 24
200-207	Informations about DALI node 25
208-215	Informations about DALI node 26
216-223	Informations about DALI node 27
224-231	Informations about DALI node 28
232-239	Informations about DALI node 29
240-247	Informations about DALI node 30
248-255	Informations about DALI node 31

Modbus Register	Meaning
256-263	Informations about DALI node 32
264-271	Informations about DALI node 33
272-279	Informations about DALI node 34
280-287	Informations about DALI node 35
288-295	Informations about DALI node 36
296-303	Informations about DALI node 37
304-311	Informations about DALI node 38
312-319	Informations about DALI node 39
320-327	Informations about DALI node 40
328-335	Informations about DALI node 41
336-343	Informations about DALI node 42
344-351	Informations about DALI node 43
352-369	Informations about DALI node 44
360-377	Informations about DALI node 45
368-375	Informations about DALI node 46
376-383	Informations about DALI node 47
384-391	Informations about DALI node 48
392-399	Informations about DALI node 49
400-407	Informations about DALI node 50
408-415	Informations about DALI node 51
416-423	Informations about DALI node 52
424-431	Informations about DALI node 53
432-439	Informations about DALI node 54
440-447	Informations about DALI node 55
448-455	Informations about DALI node 56
456-463	Informations about DALI node 57
464-471	Informations about DALI node 58
472-479	Informations about DALI node 59
480-487	Informations about DALI node 60
488-495	Informations about DALI node 61
496-503	Informations about DALI node 62
504-511	Informations about DALI node 63

The generic structure of 8 bytes reserved for each DALI node is described below:

Offset	Description
0	Status of DALI node
1	ADV of DALI node
2	Response received after command from DALI node
3	<ul style="list-style-type: none"> ➤ Bit 0, 1, 2, 3 (least significant) = Type of DALI node ➤ Bit 4, 5, 6, 7 (most significant) = Version of DALI node
4	Min. settable value of DALI node

5	Max. settable value of DALI node
6	<p>Each bit has a different meaning. '0' means 'Group not configured', '1' means 'Group configured'.</p> <ul style="list-style-type: none"> ↕ Bit 0 (less significant) = Group 0 ↕ Bit 1 = Group 1 ↕ Bit 2 = Group 2 ↕ Bit 3 = Group 3 ↕ Bit 4 = Group 4 ↕ Bit 5 = Group 5 ↕ Bit 6 = Group 6 ↕ Bit 7 (most significant) = Group 7
7	<ul style="list-style-type: none"> ↕ Bit 0 (least significant) = Group 8 ↕ Bit 1 = Group 9 ↕ Bit 2 = Group 10 ↕ Bit 3 = Group 11 ↕ Bit 4 = Group 12 ↕ Bit 5 = Group 13 ↕ Bit 6 = Group 14 ↕ Bit 7 (most significant) = Group 15

Structure of the array in IN (data taken from the converter and written to DALI devices)

ADV SETTING FOR SINGLE DALI NODES	
Position/Byte	Description
0	ADV to set on DALI node 0
1	ADV to set on DALI node 1
2	ADV to set on DALI node 2
3	ADV to set on DALI node 3
4	ADV to set on DALI node 4
5	ADV to set on DALI node 5
6	ADV to set on DALI node 6
7	ADV to set on DALI node 7
8	ADV to set on DALI node 8
9	ADV to set on DALI node 9
10	ADV to set on DALI node 10
11	ADV to set on DALI node 11
12	ADV to set on DALI node 12
13	ADV to set on DALI node 13
14	ADV to set on DALI node 14
15	ADV to set on DALI node 15
16	ADV to set on DALI node 16
17	ADV to set on DALI node 17
18	ADV to set on DALI node 18
19	ADV to set on DALI node 19
20	ADV to set on DALI node 20

21	ADV to set on DALI node 21
22	ADV to set on DALI node 22
23	ADV to set on DALI node 23
24	ADV to set on DALI node 24
25	ADV to set on DALI node 25
26	ADV to set on DALI node 26
27	ADV to set on DALI node 27
28	ADV to set on DALI node 28
29	ADV to set on DALI node 29
30	ADV to set on DALI node 30
31	ADV to set on DALI node 31
32	ADV to set on DALI node 32
33	ADV to set on DALI node 33
34	ADV to set on DALI node 34
35	ADV to set on DALI node 35
36	ADV to set on DALI node 36
37	ADV to set on DALI node 37
38	ADV to set on DALI node 38
39	ADV to set on DALI node 39
40	ADV to set on DALI node 40
41	ADV to set on DALI node 41
42	ADV to set on DALI node 42
43	ADV to set on DALI node 43
44	ADV to set on DALI node 44

45	ADV to set on DALI node 45
46	ADV to set on DALI node 46
47	ADV to set on DALI node 47
48	ADV to set on DALI node 48
49	ADV to set on DALI node 49
50	ADV to set on DALI node 50
51	ADV to set on DALI node 51
52	ADV to set on DALI node 52
53	ADV to set on DALI node 53
54	ADV to set on DALI node 54
55	ADV to set on DALI node 55
56	ADV to set on DALI node 56
57	ADV to set on DALI node 57
58	ADV to set on DALI node 58
59	ADV to set on DALI node 59
60	ADV to set on DALI node 60
61	ADV to set on DALI node 61
62	ADV to set on DALI node 62
63	ADV to set on DALI node 63

ADV SETTING FOR GROUPS	
Position/Byte	Description
64	ADV to set on Group 0
65	ADV to set on Group 1
66	ADV to set on Group 2
67	ADV to set on Group 3
68	ADV to set on Group 4
69	ADV to set on Group 5
70	ADV to set on Group 6
71	ADV to set on Group 7
72	ADV to set on Group 8
73	ADV to set on Group 9
74	ADV to set on Group 10
75	ADV to set on Group 11
76	ADV to set on Group 12
77	ADV to set on Group 13
78	ADV to set on Group 14
79	ADV to set on Group 15

ADV SETTING (BROADCAST)	
Position/Byte	Description
80	ADV to set

**Note:**

The range of ADV can be from 0 to 255. The minimum and the maximum value of the ADV for each DALI node depends on the setting of the DALI node. These values can be programmed using "DALI Console" software.

SCENE CONTROL	
Position/Byte	Description
128	Control byte: it must be increased of +1 every times that the command must be sent on DALI.
129	ID of DALI device to command (for commands, most significant bit must be set to '1' as DALI specifications): <ul style="list-style-type: none"> ↘ 0-63 = Single DALI device ↘ 64-79 = Groups ↘ 127 = Broadcast
130	Scene to control: <ul style="list-style-type: none"> ↘ 0x10 = Scene 0 ↘ 0x11 = Scene 1 ↘ 0x12 = Scene 2 ↘ 0x13 = Scene 3 ↘ 0x14 = Scene 4 ↘ 0x15 = Scene 5 ↘ 0x16 = Scene 6 ↘ 0x17 = Scene 7 ↘ 0x18 = Scene 8 ↘ 0x19 = Scene 9 ↘ 0x1A = Scene 10 ↘ 0x1B = Scene 11 ↘ 0x1C = Scene 12 ↘ 0x1D = Scene 13 ↘ 0x1E = Scene 14 ↘ 0x1F = Scene 15

MECHANICAL DIMENSIONS:

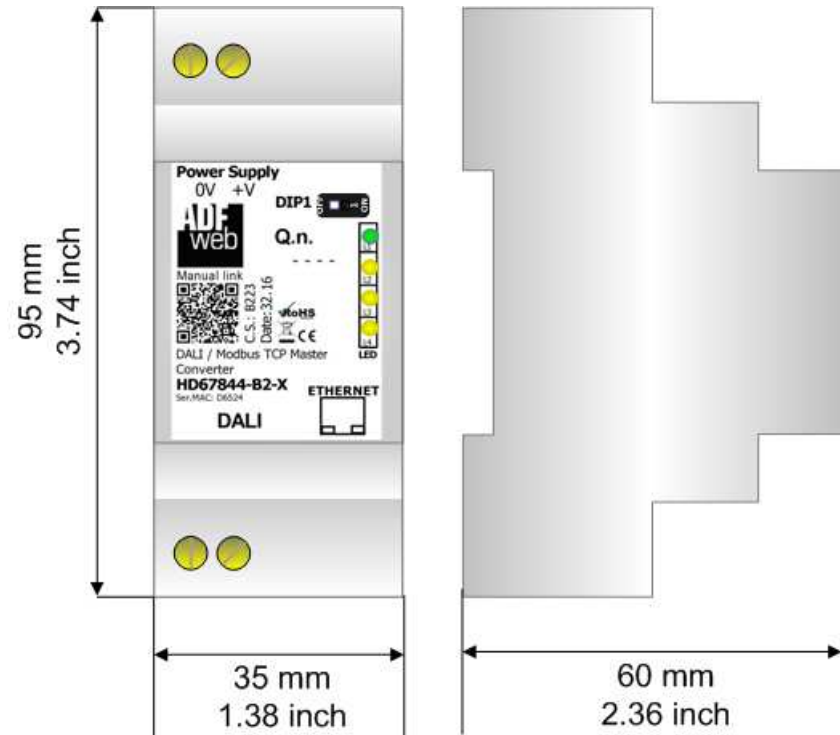

Housing: PVC
 Weight: 200g
 (Approx)

Figure 15: Mechanical dimensions scheme for HD67844-B2-x

ORDERING INFORMATIONS:

The ordering part number is formed by a valid combination of the following:

HD67844 - B 2 - x

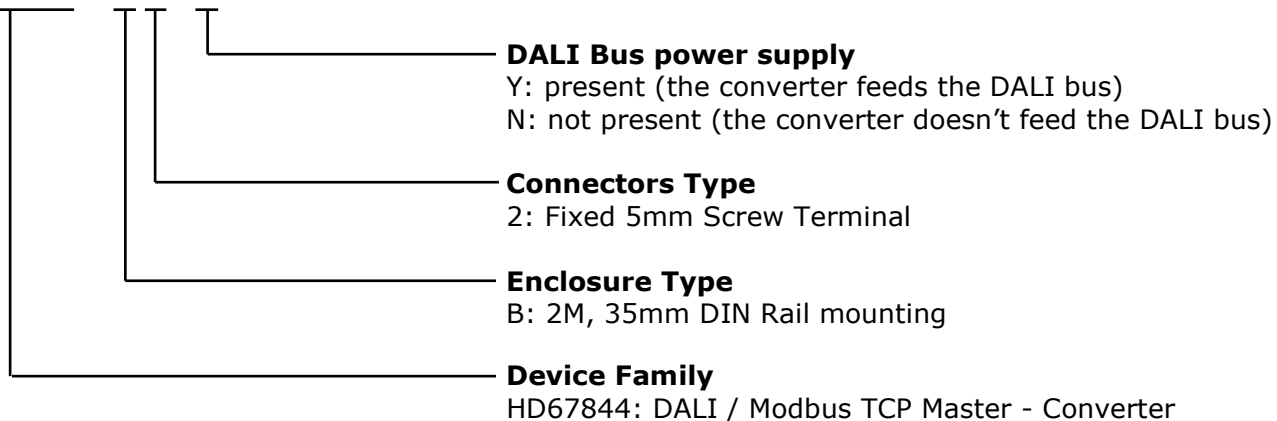

- Order Code: **HD67844-B2-Y** - DALI / Modbus TCP Master – Converter (DALI bus power supply present)
 Order Code: **HD67844-B2-N** - DALI / Modbus TCP Master – Converter (DALI bus power supply not present)

ACCESSORIES:

- Order Code: **AC34001** - 35mm Rail DIN - Power Supply 220/240V AC 50/60Hz – 12 V AC
 Order Code: **AC34002** - 35mm Rail DIN - Power Supply 110V AC 50/60Hz – 12 V AC

DISCLAIMER:

All technical content within this document can be modified without notice. The content of the document is a under continual renewal. For losses due to fire, earthquake, third party access or other accidents, or intentional or accidental abuse, misuse, or use under abnormal conditions repairs are charged to the user. ADFweb.com S.r.l. will not be liable for accidental loss of use or inability to use this product, such as loss of business income. ADFweb.com S.r.l. shall not be liable for consequences of improper use.

OTHER REGULATIONS AND STANDARDS:**WEEE INFORMATION**

Disposal of old electrical and electronic equipment (as in the European Union and other European countries with separate collection systems).

— This symbol on the product or on its packaging indicates that this product may not be treated as household rubbish. Instead, it should be taken to an applicable collection point for the recycling of electrical and electronic equipment. If the product is disposed correctly, you will help prevent potential negative environmental factors and impact of human health, which could otherwise be caused by inappropriate disposal. The recycling of materials will help to conserve natural resources. For more information about recycling this product, please contact your local city office, your household waste disposal service or the shop where you purchased the product.

RESTRICTION OF HAZARDOUS SUBSTANCES DIRECTIVE

The device respects the 2002/95/EC Directive on the restriction of the use of certain hazardous substances in electrical and electronic equipment (commonly referred to as Restriction of Hazardous Substances Directive or RoHS).

CE MARKING

The product conforms with the essential requirements of the applicable EC directives.

WARRANTIES AND TECHNICAL SUPPORT:

For fast and easy technical support for your ADFweb.com SRL products, consult our internet support at www.adfweb.com.
Otherwise contact us at the address support@adfweb.com

RETURN POLICY:

If while using your product you have any problem and you wish to exchange or repair it, please do the following:

- Obtain a Product Return Number (PRN) from our internet support at www.adfweb.com. Together with the request, you need to provide detailed information about the problem.
- Send the product to the address provided with the PRN, having prepaid the shipping costs (shipment costs billed to us will not be accepted).

If the product is within the warranty of twelve months, it will be repaired or exchanged and returned within three weeks. If the product is no longer under warranty, you will receive a repair estimate.

**ADFweb.com S.r.l.**

Via Strada Nuova, 17
IT-31010 Mareno di Piave
TREVISO (Italy)
Phone +39.0438.30.91.31
Fax +39.0438.49.20.99
www.adfweb.com

