

User Manual

Revision 1.100
English

Modbus Master / Ethernet - Converter

(Order Code: HD67506-A1, HD67506-B2)

Benefits and Main Features:

Very easy to configure

Low cost

32mm Rail DIN mount

⊕ Wide supply input range

⊕ Galvanic Isolation of RS485

⊕ Temperature range: -40°C/+85°C (-40°F/+185°F)

⊕

⊕

⊕



HD67506-A1



HD67506-B2



INDEX:

	Page
INDEX	2
UPDATED DOCUMENTATION	2
REVISION LIST	2
WARNING	2
TRADEMARKS	2
SECURITY ALERT	3
EXAMPLES OF CONNECTION	4
CONNECTION SCHEME	5
CHARACTERISTICS	7
CONFIGURATION	7
POWER SUPPLY	8
FUNCTION MODES	9
LEDS	10
ETHERNET	11
RS232	11
RS485	12
USE OF COMPOSITOR SW67507	13
NEW PROJECT / OPEN PROJECT	14
SOFTWARE OPTIONS	15
SET COMMUNICATION	16
SET MODBUS ACCESS	17
UPDATE VIA SERIAL	19
UPDATE VIA UDP	20
ETHERNET PROTOCOL	22
MECHANICAL DIMENSIONS	27
ORDERING INFORMATIONS	28
ACCESSORIES	28
DISCLAIMER	29
OTHER REGULATIONS AND STANDARDS	29
WARRANTIES AND TECHNICAL SUPPORT	30
RETURN POLICY	30

UPDATED DOCUMENTATION:

Dear customer, we thank you for your attention and we remind you that you need to check that the following document is:

- Updated
- Related to the product you own

To obtain the most recently updated document, note the “document code” that appears at the top right-hand corner of each page of this document.

With this “Document Code” go to web page www.adfweb.com/download/ and search for the corresponding code on the page. Click on the proper “Document Code” and download the updates.

To obtain the updated documentation for the product that you own, note the “Document Code” (Abbreviated written "Doc. Code" on the label on the product) and download the updated from our web site www.adfweb.com/download/

REVISION LIST:

Revision	Date	Author	Chapter	Description
1.010	10/11/2010	Fl	All	Software changed (v1.000)
1.011	07/02/2013	Nt	All	Added new chapters
1.012	28/02/2014	Fl	All	Revision
1.100	18/06/2014	Ff	All	New Hardware Version

WARNING:

ADFweb.com reserves the right to change information in this manual about our product without warning. ADFweb.com is not responsible for any error this manual may contain.

TRADEMARKS:

All trademarks mentioned in this document belong to their respective owners.

SECURITY ALERT:**GENERAL INFORMATION**

To ensure safe operation, the device must be operated according to the instructions in the manual. When using the device, legal and safety regulation are required for each individual application. The same applies also when using accessories.

INTENDED USE

Machines and systems must be designed so the faulty conditions do not lead to a dangerous situation for the operator (i.e. independent limit switches, mechanical interlocks, etc.).

QUALIFIED PERSONNEL

The device can be used only by qualified personnel, strictly in accordance with the specifications. Qualified personnel are persons who are familiar with the installation, assembly, commissioning and operation of this equipment and who have appropriate qualifications for their job.

RESIDUAL RISKS

The device is state-of-the-art and is safe. The instruments can represent a potential hazard if they are inappropriately installed and operated by untrained personnel. These instructions refer to residual risks with the following symbol:



This symbol indicates that non-observance of the safety instructions is a danger for people that could lead to serious injury or death and / or the possibility of damage.

CE CONFORMITY

The declaration is made by our company. You can send an email to [or](#) give us a call if you need it.

EXAMPLES OF CONNECTION:

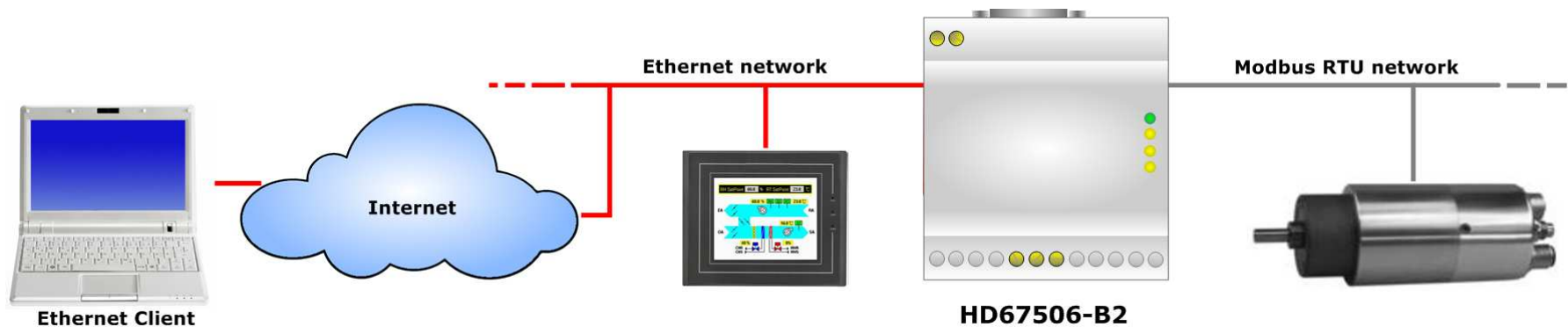
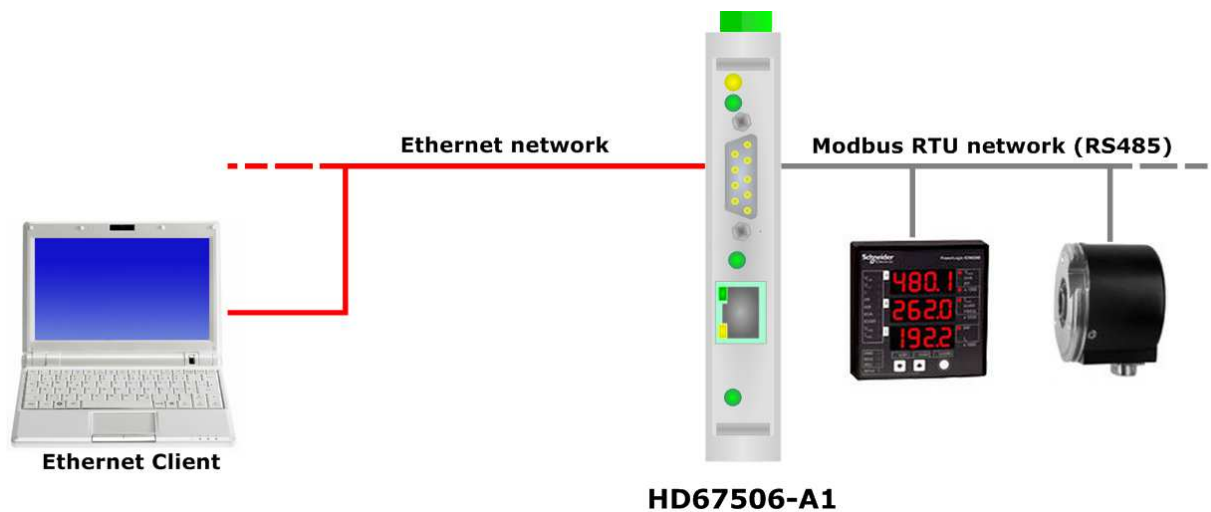

CONNECTION SCHEME:

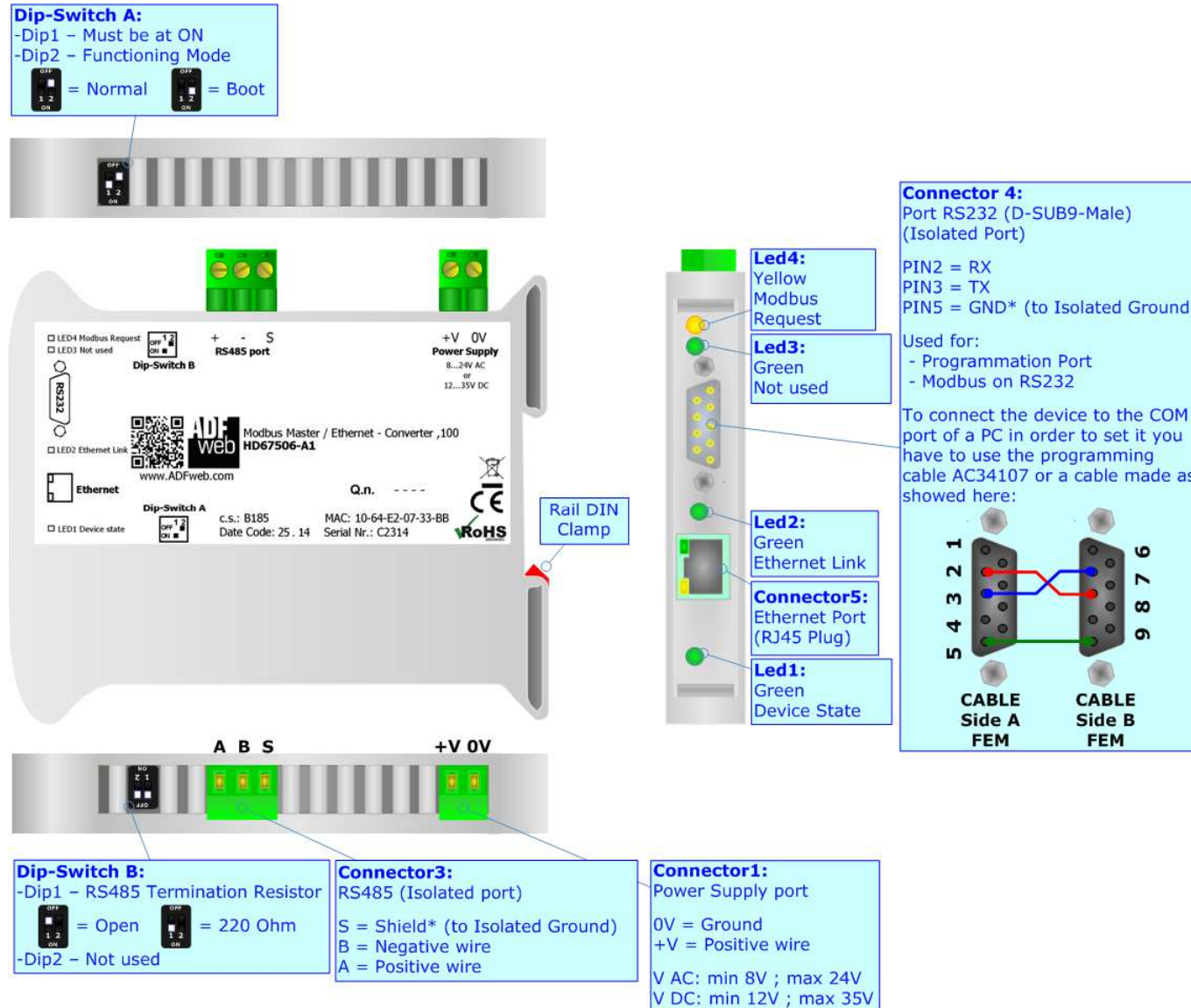

Figure 1a: Connection scheme for HD67506-A1

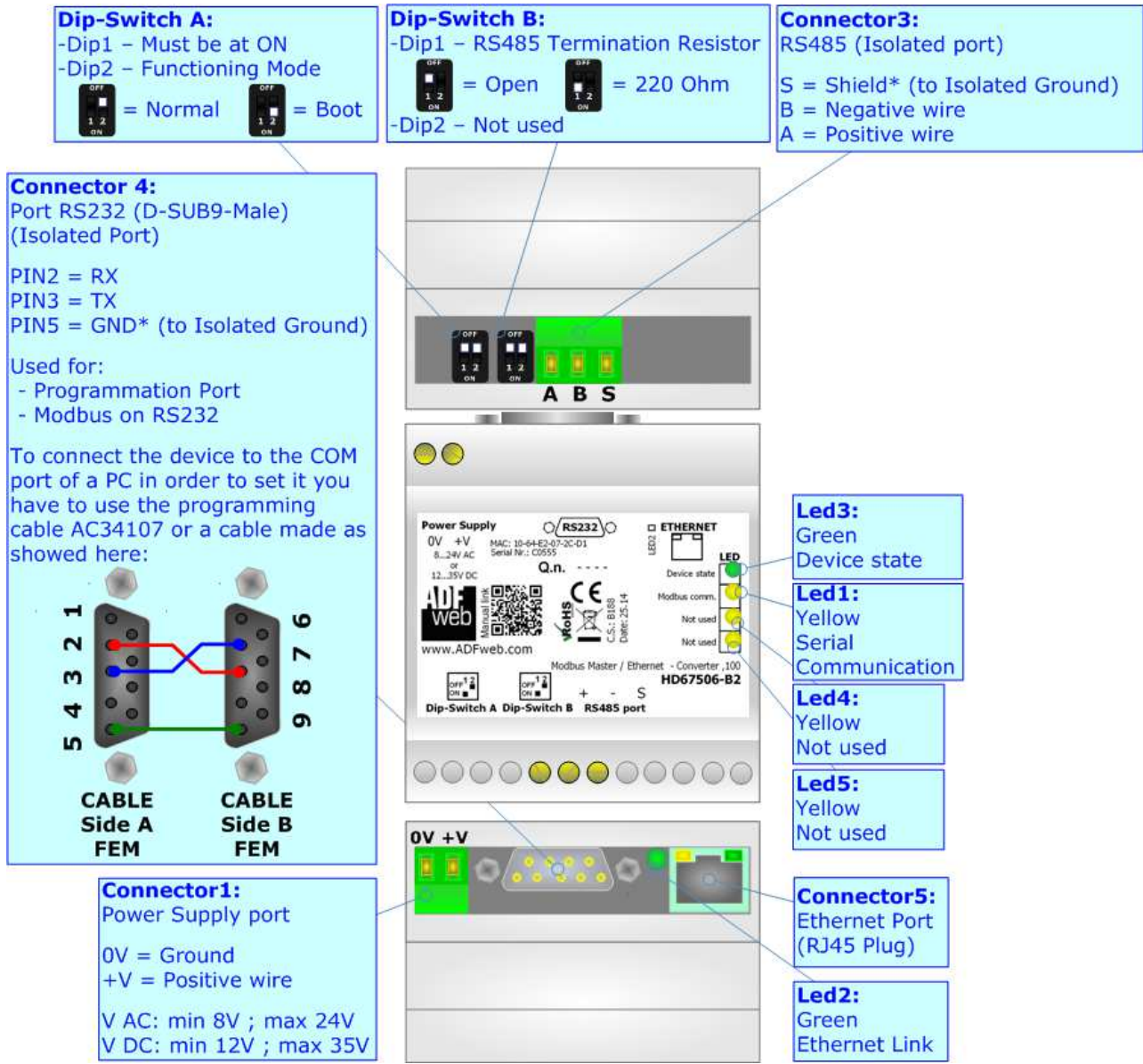

Figure 1b: Connection scheme for HD67506-B2

CHARACTERISTICS:

The HD67506-A1 and HD67506-B2 are a Modbus Master / Ethernet – Converter.

It allows for the following characteristics:

- Triple isolation between Serial - Power Supply, Serial - Ethernet, Power Supply - Ethernet.
- Ethernet 10Base-T / 100Base-T, autosensing;
- Mountable on 35mm Rail DIN;
- Wide power supply input range: 8...24V AC or 12...35V DC;
- Wide temperature range: -40°C / 85°C [-40°F / +185°F].

This device is able to manage a maximum of ten simultaneous connections from Ethernet side.

CONFIGURATION:

You need Compositor SW67506 software on your PC in order to perform the following:

- Define the parameters of Ethernet line;
- Define the parameters of Modbus line;
- Update the device.

POWER SUPPLY:

The devices can be powered at 8...24V AC and 12...35V DC. For more details see the two tables below.

VAC		VDC	
Vmin	Vmax	Vmin	Vmax
8V	24V	12V	35V

Consumption at 24V DC:

Device	Consumption [W/VA]
HD67506-A1	3.5
HD67506-B2	3.5

Caution: Not reverse the polarity power

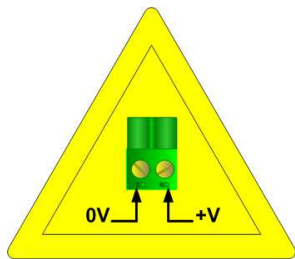

HD67506-A1

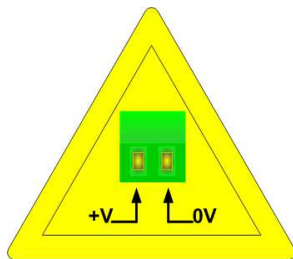

HD67506-B2

Connector1:
Power Supply port
0V = Ground
+V = Positive wire
V AC: min 8V ; max 24V
V DC: min 12V ; max 35V

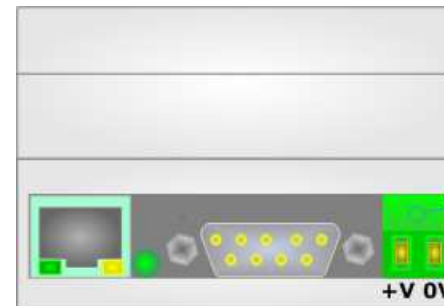
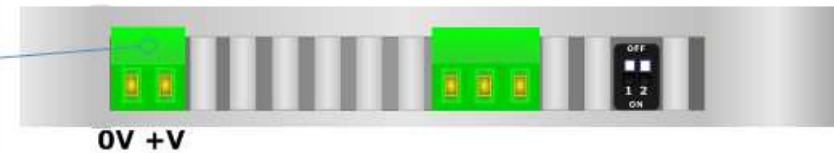

Connector1:
Power Supply port
0V = Ground
+V = Positive wire
V AC: min 8V ; max 24V
V DC: min 12V ; max 35V

FUNCTION MODES:

The device has got two function modes depending on the position of the 'Dip2 of Dip-Switch A':

- The first, with 'Dip2 of Dip-Switch A' at "OFF" position, is used for the normal working of the device.
- The second, with 'Dip2 of Dip-Switch A' at "ON" position, is used for uploading the Project and/or Firmware.

For the operations to follow for the updating, see 'UPDATE DEVICE' section.

According to the functioning mode, the LEDs will have specific functions, see 'LEDS' section.

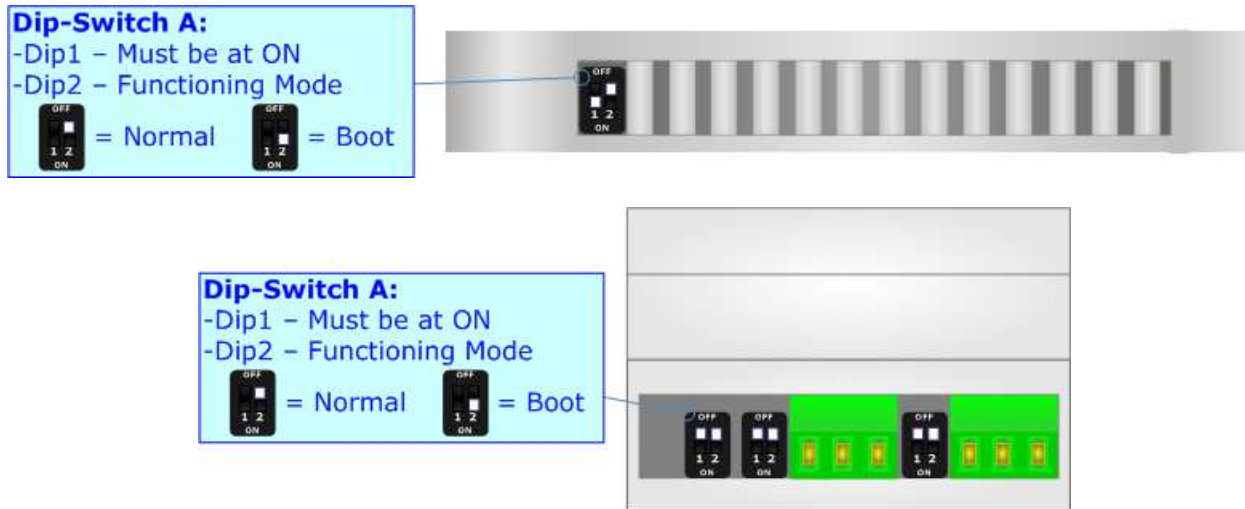

Warning:

Dip1 of 'Dip-Switch A' must be at ON position to work even if the Ethernet cable is not inserted.

LEDS:

The devices has got four (five for HD67506-B2) LEDs that are used to give information of the functioning status. The various meanings of the LEDs are described in the table below.

LED	Normal Mode	Boot Mode
1: Device state (green)	Blinks slowly (~1Hz)	Blinks quickly: Boot state Blinks very slowly (~0.5Hz): update in progress
2: Ethernet Link (green)	ON: Ethernet cable connected OFF: Ethernet cable disconnected	ON: Ethernet cable connected OFF: Ethernet cable disconnected
3: Not used (green)	OFF	Blinks quickly: Boot state Blinks very slowly (~0.5Hz): update in progress
4: Serial Communication (yellow)	Blinks when Modbus request (RS232/RS485) is sent	Blinks quickly: Boot state Blinks very slowly (~0.5Hz): update in progress
5: Not used (yellow) (Present only on HD67507-B2)	OFF	Blinks quickly: Boot state Blinks very slowly (~0.5Hz): update in progress

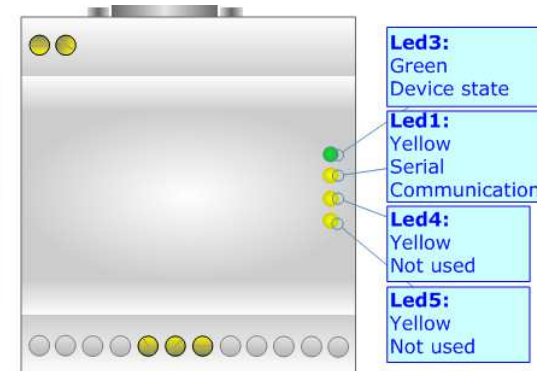
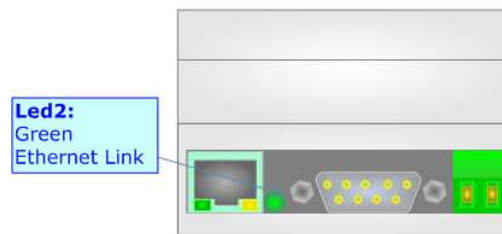
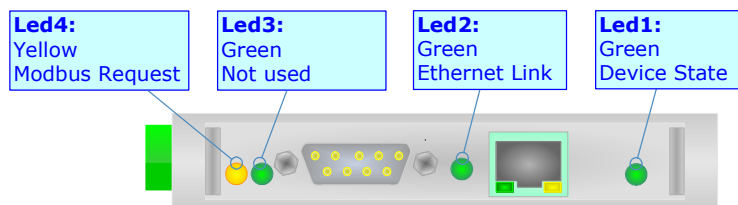

ETHERNET:

The Ethernet connection must be made using Connector5 of HD67506-A1/HD67506-B2 with at least a Category 5E cable. The maximum length of the cable should not exceed 100m. The cable has to conform to the T568 norms relative to connections in cat.5 up to 100 Mbps. To connect the device to a Hub/Switch the use of a straight cable is recommended. To connect the device to a PC/PLC/other the use of a cross cable is recommended.

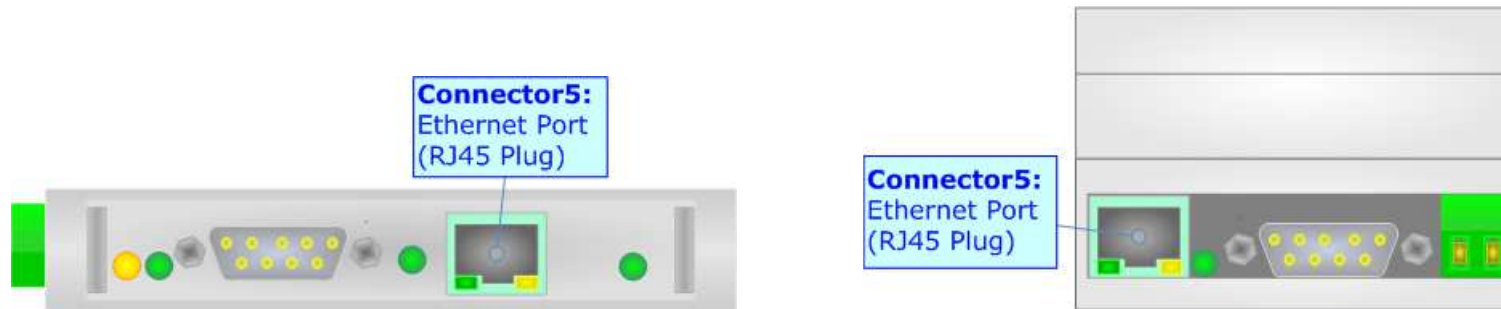

RS232:

The connection from RS232 socket to a serial port (example one from a personal computer) must be made with a Null Modem cable (a serial cable where the pins 2 and 3 are crossed).

It is recommended that the RS232 cable not exceed 15 meters.

The device is provided with a D-sub connector type DE-9 Male (also called DB-9). The cable must use a DE-9 Female connector.

The serial port is used for programming the device and for Modbus communication.

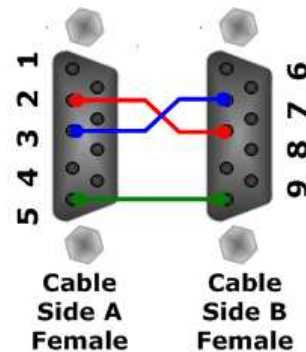

RS485:

To terminate the RS485 line with a 220Ω resistor, it is necessary to put dip 1 ON, like in figure.

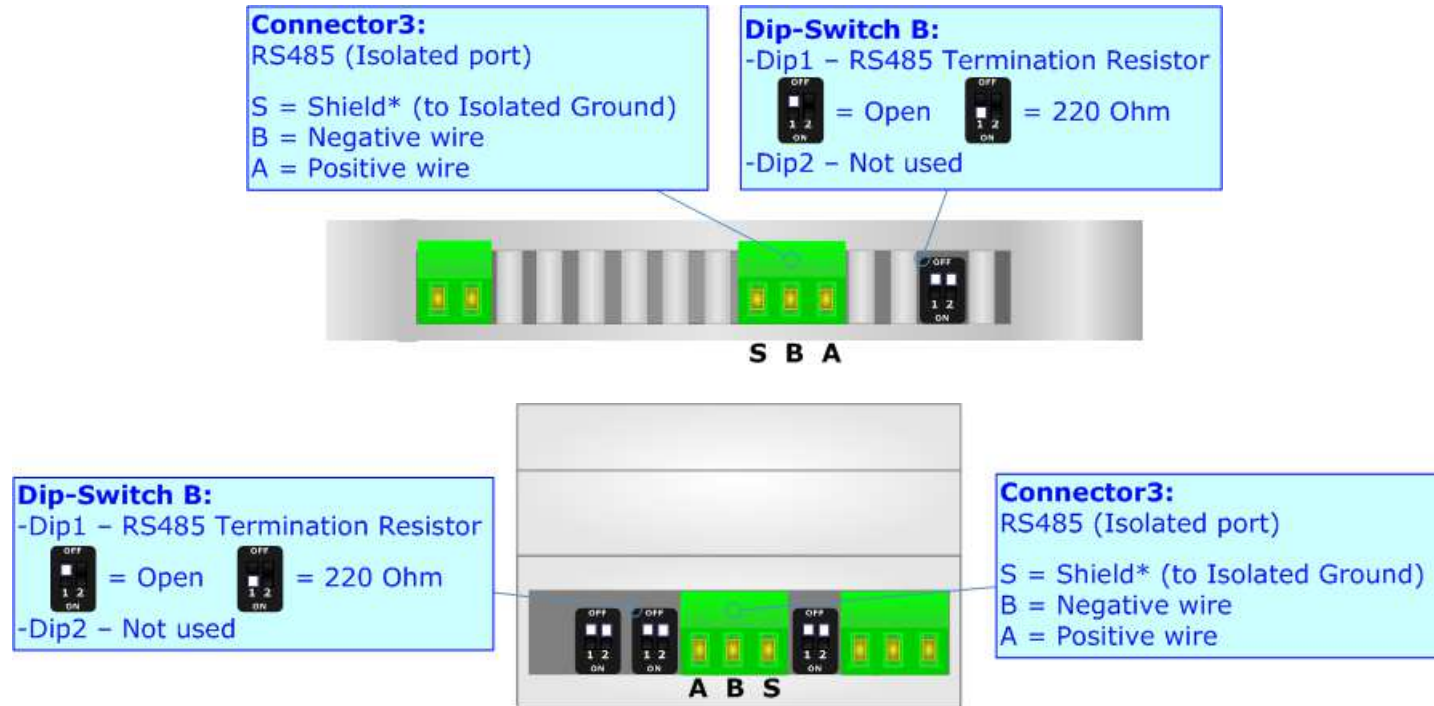

The maximum length of the cable should be 1200m (4000 feet).

Here some codes of cables:

- Belden: p/n 8132 - 2x 28AWG stranded twisted pairs conductor + foil shield + braid shield;
- Belden p/n 82842 - 2x 24AWG stranded twisted pairs conductor + foil shield + braid shield;
- Tasker: p/n C521 - 1x 24AWG twisted pair conductor + foil shield + braid shield;
- Tasker: p/n C522 - 2x 24AWG twisted pairs conductor + foil shield + braid shield.

USE OF COMPOSITOR SW67506:

To configure the Converter, use the available software that runs with Windows called SW67506. It is downloadable on the site www.adfweb.com and its operation is described in this document. (*This manual is referenced to the last version of the software present on our web site*). The software works with MSWindows (XP, Vista, Seven, 8; 32/64bit).

When launching the SW67506, the window below appears (Fig. 2).

**Note:**

It is necessary to have installed .Net Framework 4.



Figure 2: Main window for SW67506

NEW CONFIGURATION / OPEN CONFIGURATION:

The “**New Configuration**” button creates the folder which contains the entire device’s configuration.



A device’s configuration can also be imported or exported:

- To clone the configurations of a programmable “Modbus Master / Ethernet - Converter” in order to configure another device in the same manner, it is necessary to maintain the folder and all its contents;
- To clone a project in order to obtain a different version of the project, it is sufficient to duplicate the project folder with another name and open the new folder with the button “**Open Configuration**”.



SOFTWARE OPTIONS:

By pressing the “**Settings**” () button there is the possibility to change the language of the software and check the updatings for the compositor.

In the section “Language” it is possible to change the language of the software.

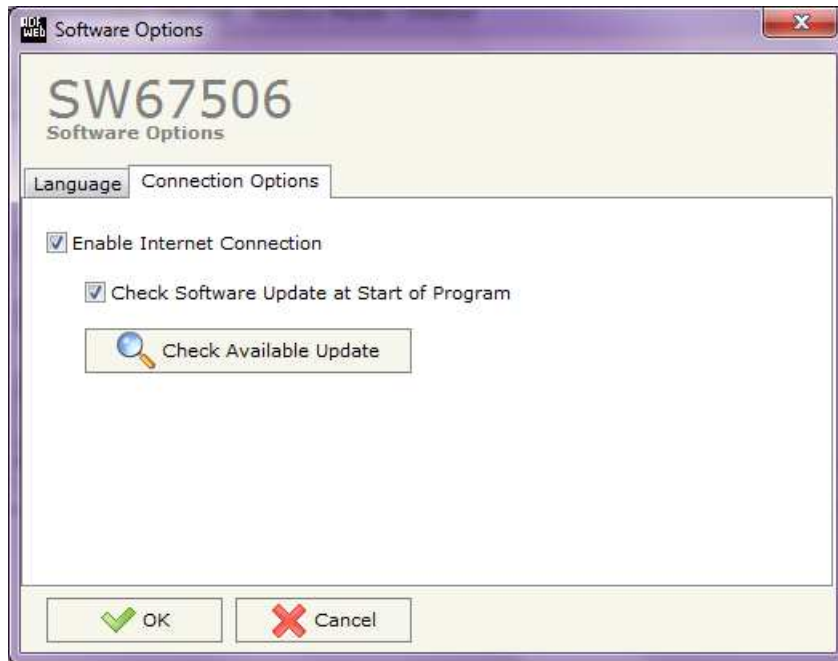

In the section “Connection Options”, it is possible to check if there are some updatings of the software compositor in ADFweb.com website. Checking the option “**Check Software Update at Start of Program**”, the SW67506 check automatically if there are updatings when it is launched.

SET COMMUNICATION:

This section define the fundamental communication parameters of two buses, Modbus and Ethernet.

By Pressing the **"Set Communication"** button from the main window for SW67506 (Fig. 2) the window "Set Communication" appears (Fig. 3).

In the section "Select Device" is possible to select the type of converter used:

- Device till April 2014 (with Jumper);
- Device from May 2014 (with Dip-Switch).

The means of the fields for "Ethernet" section are:

- In the field **"IP ADDRESS"** insert the IP address that you want to give to the Converter;
- In the field **"SUBNET Mask"** insert the SubNet Mask;
- In the field **"GATEWAY"** insert the default gateway that you want to use. This feature can be enabled or disabled pressing the Check Box field. This feature is used for going out of the net;
- In the field **"Port"** the port number used for Ethernet communication is defined;
- In the field **"Protocol"** is possible to set the Ethernet protocol used (TCP or UDP).

The means of the fields for the "Modbus Master" section are:

- In the field **"Serial"** the serial to use is defined (RS232 or RS485);
- In the field **"Baudrate"** the baudrate for the serial line is defined;
- In the field **"Parity"** the parity of the serial line is defined;
- In the field **"TimeOut (ms)"** there is the maximum time that the device attends for the answer from the Slave interrogated;
- In the field **"Communication Idle Time (ms)"** the minimum delay between two polls is defined (only for "Device from May 2014 (with Dip-Switch)");
- In the field **"Protocol"** is possible to set the Serial protocol used (Modbus RTU or Modbus ASCII).

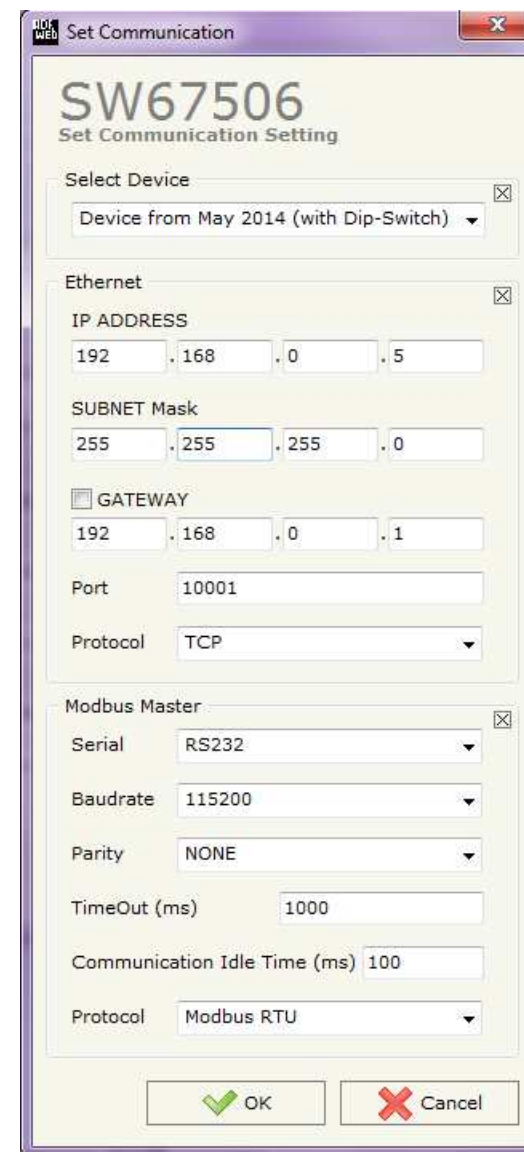

Figure 3: "Set Communication" window

SET MODBUS ACCESS:

By Pressing the "Set Modbus Access" button from the main window of SW67506 (Fig. 2), the window "Set Modbus Access" appears (Fig. 4) (only if "Device from May 2014 (with Dip-Switch)" is used).

This window is divided in two parts, the "Modbus Read" (Fig. 4a) and the "Modbus Write" (Fig. 4b). The first part "Modbus Read" is used to read the data from the Modbus slaves, and make them available to read from the Ethernet. The second part "Modbus Write" is used to write the data that arrives from Ethernet into the Modbus slaves.

The means of the fields in the window (Read) are the follows:

- In the field "Slave ID" the address of the Modbus device you have to read is defined;
- In the field "Type" insert the data type of the register you would like to read. You can choose between the following:
 - Coil Status;
 - Input Status
 - Holding Register;
 - Input Register.
- In the field "Address" the start address of the register to be read is defined;
- In the field "NPoint" insert the number of consecutive registers to be read;
- In the field "Poll Time" insert the time to make this request;
- In the field "Max Error" is the number of errors continues that the gateway waits before suspending the poll until the next reboot. If is set to zero this function is disabled;
- In the field "Position" insert the address of the Ethernet array where place the information;
- In the field "Start Bit" insert the start bit of the first byte of the field "Position" where start to insert the data read. Valid only for the "Coil Status" and "Input Status".
- In the field "Mnemonic" the description for the request is defined.

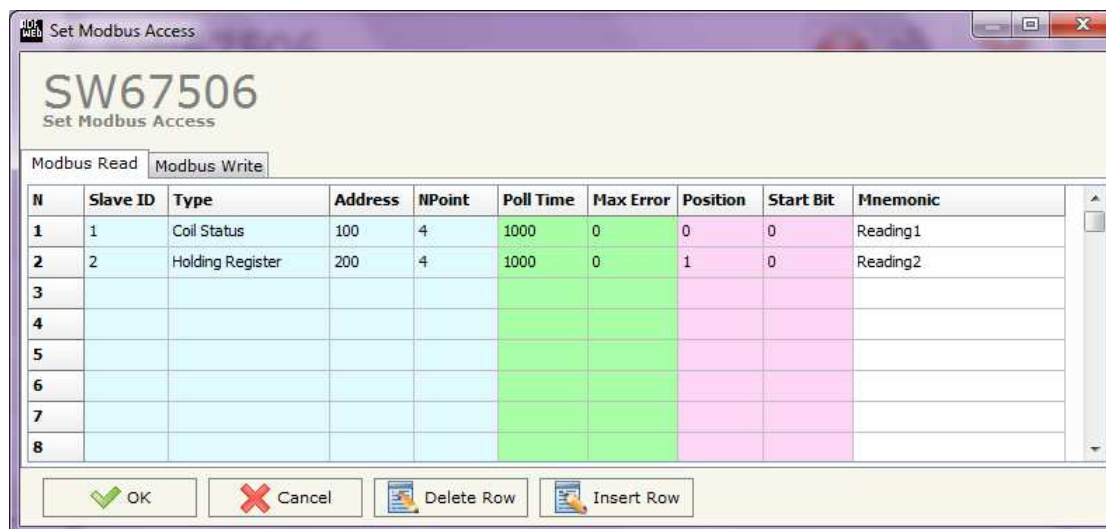

Figure 4a: "Set Modbus Access → Modbus Read" window

The means of the fields in the window (Write) are the follows:

- ✚ In the field "**Slave ID**" the address of the Modbus device that you have to write is defined;
- ✚ In the field "**Type**" insert the data type of the register you would like to read. You can choose between the following:
 - Coil Status;
 - Holding Register;
- ✚ In the field "**Address**" the start address of the register to be written is defined;
- ✚ In the field "**NPoint**" insert the number of consecutive registers to be written;
- ✚ In the field "**Poll Time**" insert the time to make this request;
- ✚ If the field "**On Change**" is checked, the gateway send the Write request in Modbus when the data change the value.
- ✚ In the field "**Max Error**" is the number of errors continues that the gateway waits before suspending the poll until the next reboot. If is set to zero this function is disabled;
- ✚ In the field "**Position**" insert the address of the Ethernet array where read the information;
- ✚ In the field "**Start Bit**" insert the start bit of the first byte of the field "Position" where start to read the data to write. Valid only for the "Coil Status";
- ✚ In the field "**Mnemonic**" the description for the request is defined.

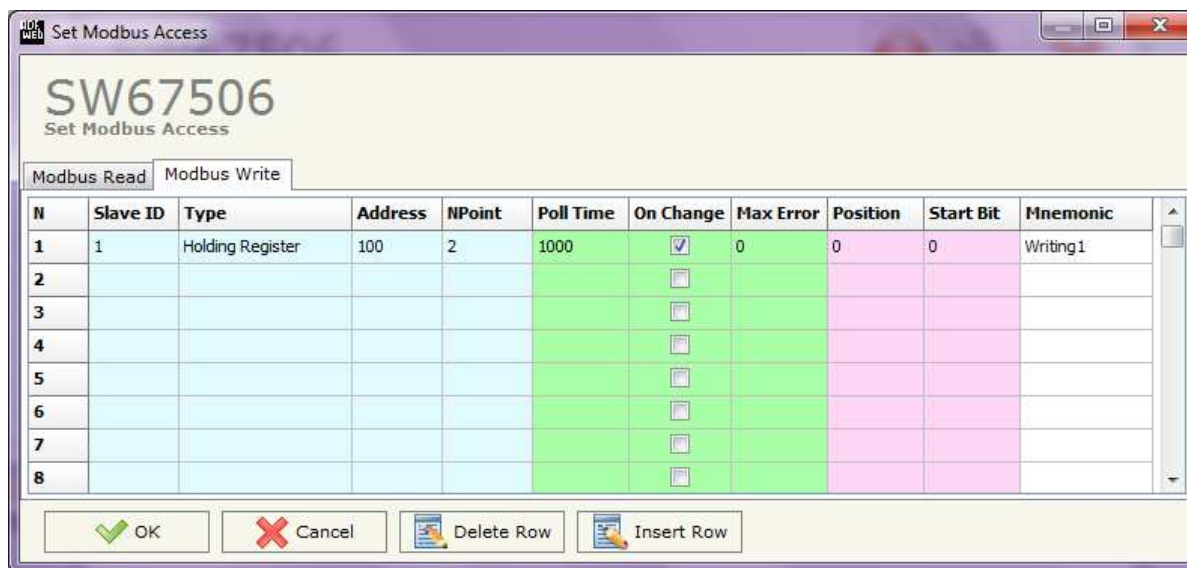

Figure 4b: "Set Modbus Access → Modbus Write" window

UPDATE DEVICE (VIA SERIAL):

By pressing the **"Update Device"** button (if "Device till April 2014 (with Jumper)" is used) it is possible to load the created Configuration into the device, and also the Firmware if is necessary, using the RS232 port.

In order to load the parameters or update the firmware in the device, follow these instructions:

- Turn off the Device;
- Connect the RS232 Null Modem cable form your PC to the Converter;
- Put Dip2 of 'Dip-Switch A' in ON position;
- Select the **"COM port"** and press the **"Connect"** button;
- Turn on the device;
- Check the "Device state" Led. It must blink quickly (see "LEDS" section);
- Press the **"Next"** button;
- Select which operations you want to do.
- Press the **"Execute update firmware"** button to start the upload;
- When all the operations are "OK" turn off the device;
- Put Dip2 of 'Dip-Switch A' in OFF position;
- Disconnect the RS232 cable;
- Turn on the device.

At this point the configuration/firmware on the device is correctly updated.

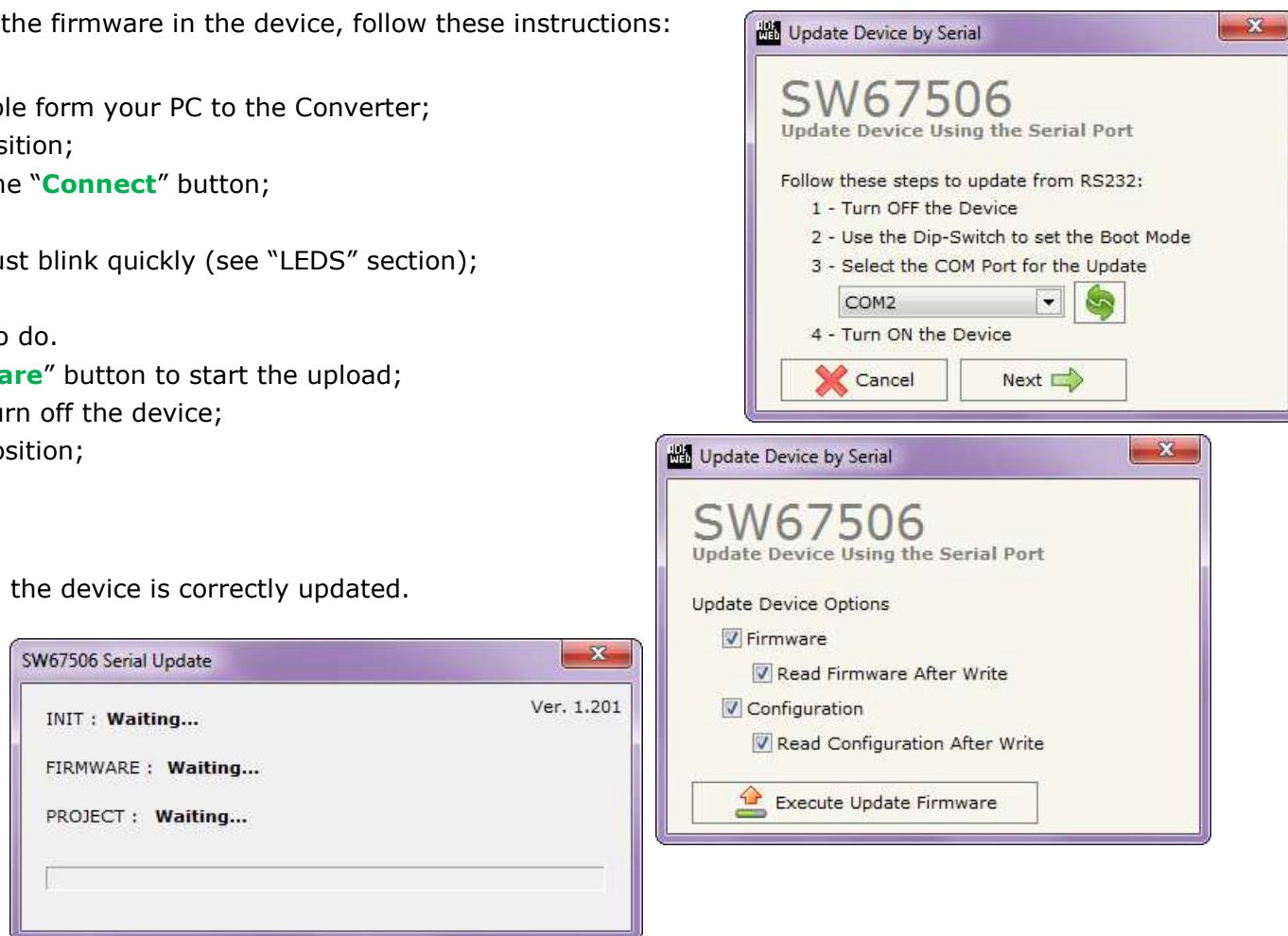

Figure 5: "Update device (via Serial)" windows

UPDATE DEVICE (VIA ETHERNET):

By pressing the **"Update Device"** button (if "Device from May 2014 (with Dip-Switch)" is used), it is possible to load the created Configuration into the device; and also the Firmware, if necessary.

If you don't know the actual IP address of the device you have to use this procedure:

- Turn off the Device;
- Put Dip2 of 'Dip-Switch A' in ON position;
- Turn on the device
- Connect the Ethernet cable;
- Insert the IP **"192.168.2.205"**;
- Press the **"Ping"** button, "Device Found! must appear";
- Press the **"Next"** button;
- Select which operations you want to do;
- Press the **"Execute update firmware"** button to start the upload;
- When all the operations are "OK" turn off the Device;
- Put Dip2 of 'Dip-Switch A' in OFF position;
- Turn on the device.

At this point the configuration/firmware on the device is correctly updated.

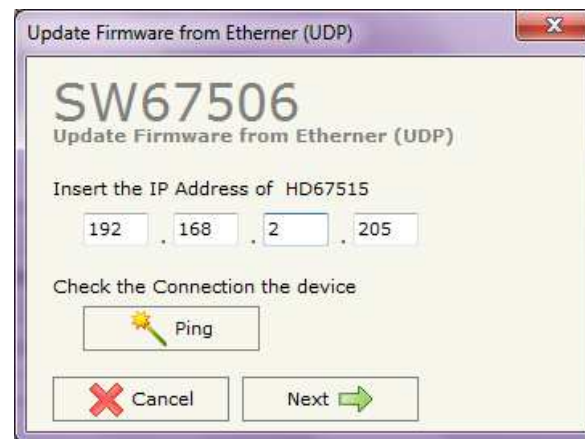
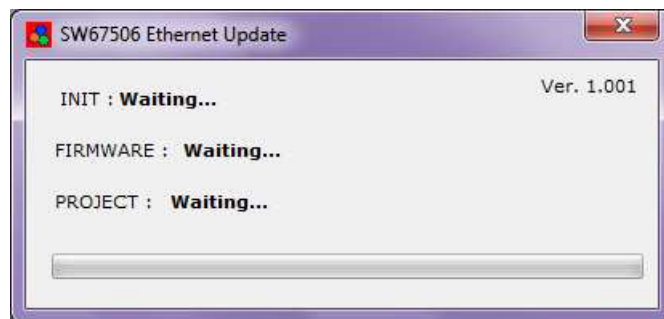

Figure 6: "Update device (via Ethernet)" windows

If you know the actual IP address of the device, you have to use this procedure:

- Turn on the Device with the Ethernet cable inserted;
- Insert the actual IP of the Converter;
- Press the "**Ping**" button, must appear "Device Found!";
- Press the "**Next**" button;
- Select which operations you want to do;
- Press the "**Execute update firmware**" button to start the upload;
- When all the operations are "OK" the device automatically goes at Normal Mode.

At this point the configuration/firmware on the device is correctly update.



Note:

When you install a new version of the software, if it is the first time it is better you do the update of the Firmware in the HD67506 device.



Note:

When you receive the device, for the first time, you also have to update the Firmware in the HD67506 device.



Warning:

If Fig. 6 appears when you try to do the Update try these points before seeking assistance:

- Try to repeat the operations for the update;
- Try with another PC;
- Try to restart the PC;
- If you are using the program inside a Virtual Machine, try to use it in the main Operating System;
- If you are using Windows Seven or Vista or 8, make sure that you have the administrator privileges;
- Pay attention to the Firewall lock;
- Check the LAN settings.



Figure 7: "Protection" window



In the case of HD67506 you have to use the software "SW67506": www.adfweb.com/download/filefold/SW67506.zip.

ETHERNET PROTOCOL:

This protocol is able to read and write frames in the Modbus net. This protocol is very simple; you must know only the "Type of Data", the "Device Address" and the "Number of Point". When the device responds the answer is transferred into the Ethernet.

WRITE FRAMES:

The transmission has a fixed structure that consist of seven bytes plus the data.

Byte Number	Description
1	Write Identifier (Write=0x02)
2	Type of Data
3	Device Address
4	Start Address Hi
5	Start Address Lo
6	Number of Point Hi
7	Number of Point Lo
8÷n+1	Data

n="Number of Point *2" if Type of Data is 0x10 or n="(Number of Point+7)/8" if Type of Data is 0x0F

The "Type of Data" (Byte Number 2) can have four values:

- 0x05: Write single Coil Status
- 0x06: Write single Holding Register
- 0x0F: Write multiple Coil Register
- 0x10: Write multiple Holding Register

The Bytes that composed the respons are these:

Byte Number	Description
1	Status of operation

The "Status of operation" (Byte Number 1) can have these values:

- 0xFF: Ok;
- 0xFE: Different from Write;
- 0xFC: Writing but function different from 5,6,15,16;
- 0xFB: The slave interrogated hasn't replied in the TimeOut time;
- 0xFA: The reply CRC is wrong;
- 0xF9: Returned function is different from the one requested;
- 0xF7: Number of byte less than 9;
- 0xF6: Number of data to wrote is different from 1 or the frame length is wrong if the function is 5,6;
- 0xF5: Number of data to wrote is less than 1 or the frame length is wrong if the function is 15,16;
- 0x03: Illegal data value, the value referenced in the data field is not allowable in the addressed slave location;
- 0x02: Illegal data address, the address referenced in the data field is not an allowable address for the addressed slave device;
- 0x01: Illegal function, the message function received is not an allowable action for the addressed slave.

Examples:

1) We want to write two points with the following features:

➤ Type of Data: Holding Register; Device Address: 5; Start Address: 0x0115; Number of Point: 2; Data 1: 0x1122; Data 2: 0x3344.

So the string of hexadecimal numbers is:

REQ:[02][10][05][01][15][00][02][11][22][33][44]

RES:[FF]

2) We want to set to 1 the Coil Status at address 0x115:

➤ Type of Data: Coil Status; Device Address: 5; Start Address: 0x0115; Number of Point: 1; Data 1: 0xFF00.

So the string of hexadecimal numbers is:

REQ:[02][05][05][01][15][00][01][FF][00]

RES:[FF]

READ FRAMES:

The transmission has a fixed structure that consist of seven byte.

Byte Number	Description
1	Read Identifier (Read=0x01)
2	Type of Data
3	Device Address
4	Start Address Hi
5	Start Address Lo
6	Number of Point Hi
7	Number of Point Lo

The "Type of Data" (Byte Number 2) can have four values:

- ➔ 0x01: Coil Status
- ➔ 0x02: Input Status
- ➔ 0x03: Holding Register
- ➔ 0x04: Input Register

READ/WRITE ETHERNET ARRAY (“SET MODBUS ACCESS” TABLE, ONLY FOR HARDWARE VERSION WITH DIP-SWITCHES):

The transmission has a fixed structure that consist of seven bytes plus the data.

Byte Number	Description
1	Command Identifier (0x03)
2	Start Position Read Hi
3	Start Position Read Lo
4	Number of Positions to Read Hi
5	Number of Positions to Read Lo
6	Start Position Write Hi
7	Start Position Write Lo
8	Number of Positions to Write Hi
9	Number of Positions to Write Lo
10÷n+1	Data

n=Number of positions to write

If you don't want to read any data, you have to put the "Read" fields to '0'.

If you don't want to write any data, you have to put the "Write" fields to '0' and the Ethernet frame will have only 9 bytes.



Note:

The Ethernet arrays in writing and in reading have a maximum dimension of 1000 bytes (positions).

The response includes the following byte:

Byte Number	Description
1	Write Error Byte
2	Read Error Byte
3÷n+2	Data Read

n=Number of Byte to Read

The Error bytes (Byte 1/Byte 2) can have three values:

- 0xFF: No error (Read/Write);
- 0x01: Starting Position doesn't exist (Read/Write);
- 0x02: Number of Positions too much higher (higher than 1000) (Read/Write);
- 0x03: Too many Data to Read/Write (Read/Write);
- 0x04: Too few data to write (only Write).

Examples:

- 1) We want to read the byte (position) 7 of the Ethernet array in reading for 10 consecutive bytes (positions) and to write 8 bytes (positions) starting from byte (position) 1 of the Ethernet array in writing. The data to write is 0x11 22 33 44 55 66 77 88.

So the string of hexadecimal numbers to send is:

REQ:[03][00][07][00][0A][00][01][00][08][11][22][33][44][55][66][77][88]
 RES:[FF][FF][xx][xx][xx][xx][xx][xx][xx][xx][xx][xx]

where 'xx' is the data read.

MECHANICAL DIMENSIONS:

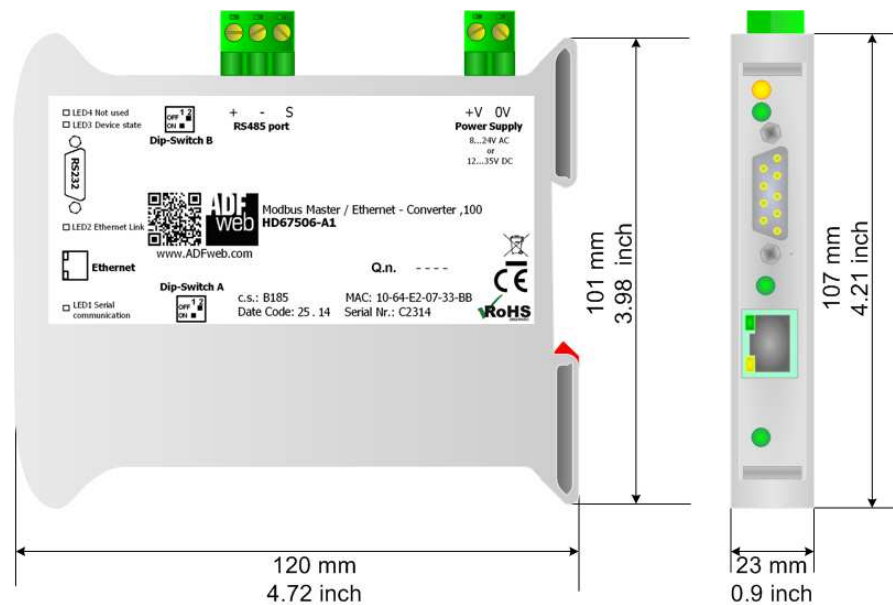

Housing: PVC
Weight: 200g (Approx)

Figure 8: Mechanical dimensions scheme for HD67506-A1

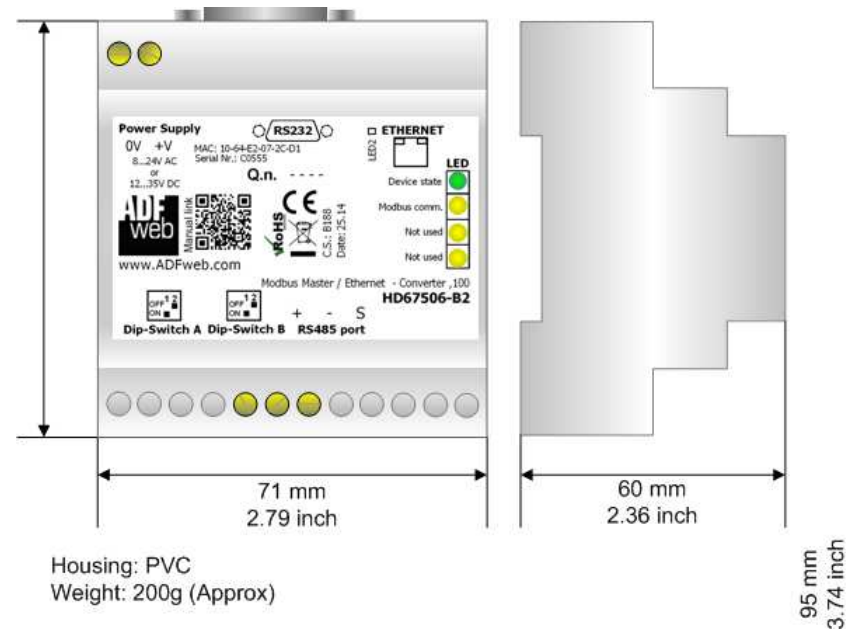

Housing: PVC
Weight: 200g (Approx)

Figure 9: Mechanical dimensions scheme for HD67506-B2

ORDERING INFORMATIONS:

The ordering part number is formed by a valid combination of the following:

HD67506 - A 1

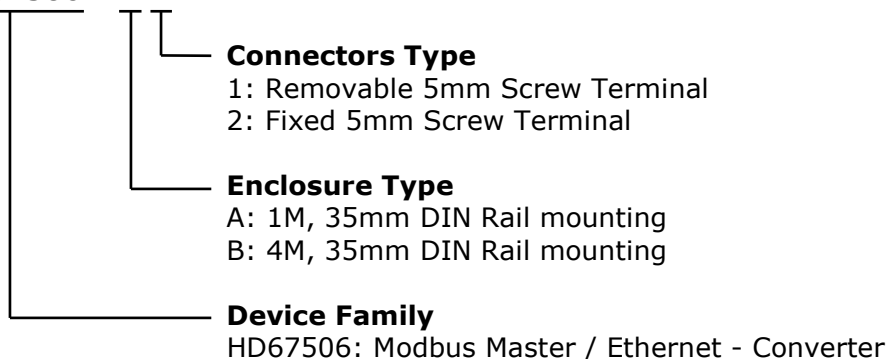

Order Code: **HD67506-A1** - Modbus Master / Ethernet - Converter (Housing type: A, Terminal Blocks Connectors)

Order Code: **HD67506-B2** - Modbus Master / Ethernet - Converter (Housing type: B, Terminal Blocks Connectors)

ACCESSORIES:

Order Code: **AC34107** - Null Modem Cable Fem/Fem D-sub 9 Pin 1,5 m

Order Code: **AC34114** - Null Modem Cable Fem/Fem D-sub 9 Pin 5 m

Order Code: **AC34001** - Rail DIN - Power Supply 220/240V AC 50/60Hz – 12 V AC

Order Code: **AC34002** - Rail DIN - Power Supply 110V AC 50/60Hz – 12 V AC

DISCLAIMER:

All technical content within this document can be modified without notice. The content of the document is a under continual renewal. For losses due to fire, earthquake, third party access or other accidents, or intentional or accidental abuse, misuse, or use under abnormal conditions repairs are charged to the user. ADFweb.com S.r.l. will not be liable for accidental loss of use or inability to use this product, such as loss of business income. ADFweb.com S.r.l. shall not be liable for consequences of improper use.

OTHER REGULATIONS AND STANDARDS:**WEEE INFORMATION**

Disposal of old electrical and electronic equipment (as in the European Union and other European countries with separate collection systems).

— This symbol on the product or on its packaging indicates that this product may not be treated as household rubbish. Instead, it should be taken to an applicable collection point for the recycling of electrical and electronic equipment. If the product is disposed correctly, you will help prevent potential negative environmental factors and impact of human health, which could otherwise be caused by inappropriate disposal. The recycling of materials will help to conserve natural resources. For more information about recycling this product, please contact your local city office, your household waste disposal service or the shop where you purchased the product.

RESTRICTION OF HAZARDOUS SUBSTANCES DIRECTIVE

The device respects the 2002/95/EC Directive on the restriction of the use of certain hazardous substances in electrical and electronic equipment (commonly referred to as Restriction of Hazardous Substances Directive or RoHS).

CE MARKING

The product conforms with the essential requirements of the applicable EC directives.

WARRANTIES AND TECHNICAL SUPPORT:

For fast and easy technical support for your ADFweb.com SRL products, consult our internet support at www.adfweb.com. Otherwise contact us at the address support@adfweb.com

RETURN POLICY:

If while using your product you have any problem and you wish to exchange or repair it, please do the following:

- ➔ Obtain a Product Return Number (PRN) from our internet support at www.adfweb.com. Together with the request, you need to provide detailed information about the problem.
- ➔ Send the product to the address provided with the PRN, having prepaid the shipping costs (shipment costs billed to us will not be accepted).

If the product is within the warranty of twelve months, it will be repaired or exchanged and returned within three weeks. If the product is no longer under warranty, you will receive a repair estimate.



ADFweb.com S.r.l.
Via Strada Nuova, 17
IT-31010 Mareno di Piave
TREVISO (Italy)
Phone +39.0438.30.91.31
Fax +39.0438.49.20.99
www.adfweb.com

