

User Manual

Revision 1.001
English

Ethernet/IP / Modbus Master - Converter

(Order Code: HD67591-232-A1, HD67591-485-A1)

Benefits and Main Features:

- ▶ Very easy to configure
- ▶ Electrical isolation
- ▶ Two Ethernet/IP ports
- ▶ Temperature range: -40°C/85°C (-40°F/185°F)
- ▶
- ▶



Other
Products

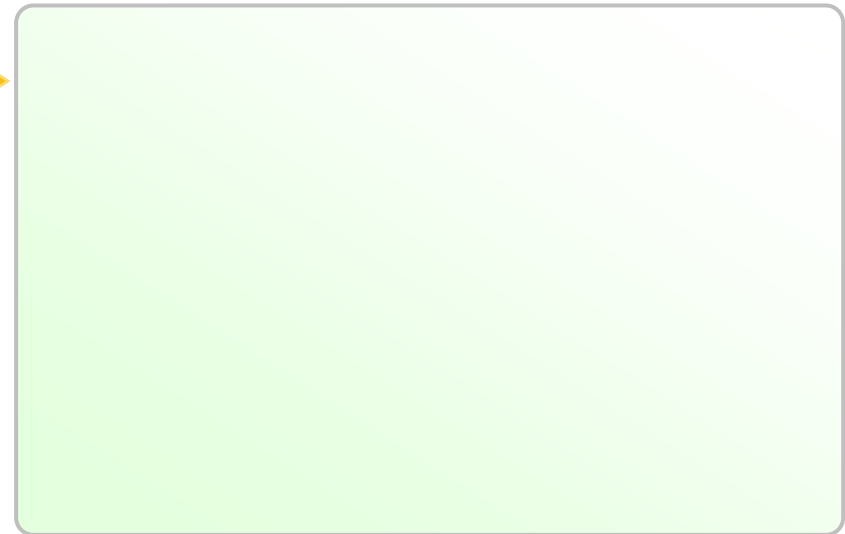

INDEX:

	Page
INDEX	2
UPDATED DOCUMENTATION	2
REVISION LIST	2
WARNING	2
TRADEMARKS	2
SECURITY ALERT	3
EXAMPLE OF CONNECTION	4
CONNECTION SCHEME	5
CHARACTERISTICS	7
CONFIGURATION	7
POWER SUPPLY	8
FUNCTION MODES	9
LEDS	10
ETHERNET/IP	11
RS485	12
RS232	12
USE OF COMPOSITOR SW67591	13
NEW PROJECT / OPEN PROJECT	13
SET COMMUNICATION	14
SET ACCESS	15
UPDATE DEVICE VIA UDP	17
MECHANICAL DIMENSIONS	19
ORDERING INFORMATIONS	20
ACCESSORIES	20
DISCLAIMER	21
OTHER REGULATIONS AND STANDARDS	21
WARRANTIES AND TECHNICAL SUPPORT	22
RETURN POLICY	22
PRODUCTS AND RELATED DOCUMENTS	22

UPDATED DOCUMENTATION:

Dear customer, we thank you for your attention and we remind you that you need to check that the following document is:

- Updated
- Related to the product you own

To obtain the most recently updated document, note the "document code" that appears at the top right-hand corner of each page of this document.

With this "Document Code" go to web page www.adfweb.com/download/ and search for the corresponding code on the page. Click on the proper "Document Code" and download the updates.

To obtain the updated documentation for the product that you own, note the "Document Code" (Abbreviated written "Doc. Code" on the label on the product) and download the updated from our web site www.adfweb.com/download/

REVISION LIST:

Revision	Date	Author	Chapter	Description
1.000	21/06/2012	Fl	All	First release version
1.001	05/03/2013	Dp	All	Add New Chapters

WARNING:

ADFweb.com reserves the right to change information in this manual about our product without warning.
ADFweb.com is not responsible for any error this manual may contain.

TRADEMARKS:

All trademarks mentioned in this document belong to their respective owners.

SECURITY ALERT:**GENERAL INFORMATION**

To ensure safe operation, the device must be operated according to the instructions in the manual. When using the device are required for each individual application, legal and safety regulation. The same applies also when using accessories.

INTENDED USE

Machines and systems must be designed so the faulty conditions do not lead to a dangerous situation for the operator (i.e. independent limit switches, mechanical interlocks, etc.).

QUALIFIED PERSONNEL

The device can be used only by qualified personnel, strictly in accordance with the specifications.

Qualified personnel are persons who are familiar with the installation, assembly, commissioning and operation of this equipment and who have appropriate qualifications for their job.

RESIDUAL RISKS

The device is state of the art and is safe. The instrument can represent a potential hazard if they are inappropriately installed and operated by personnel untrained. These instructions refer to residual risks with the following symbol:

 This symbol indicates that non-observance of the safety instructions is danger for people to serious injury or death and / or the possibility of damage.

CE CONFORMITY

The declaration is made by us. You can send an email to or give us a call if you need it.

EXAMPLE OF CONNECTION:

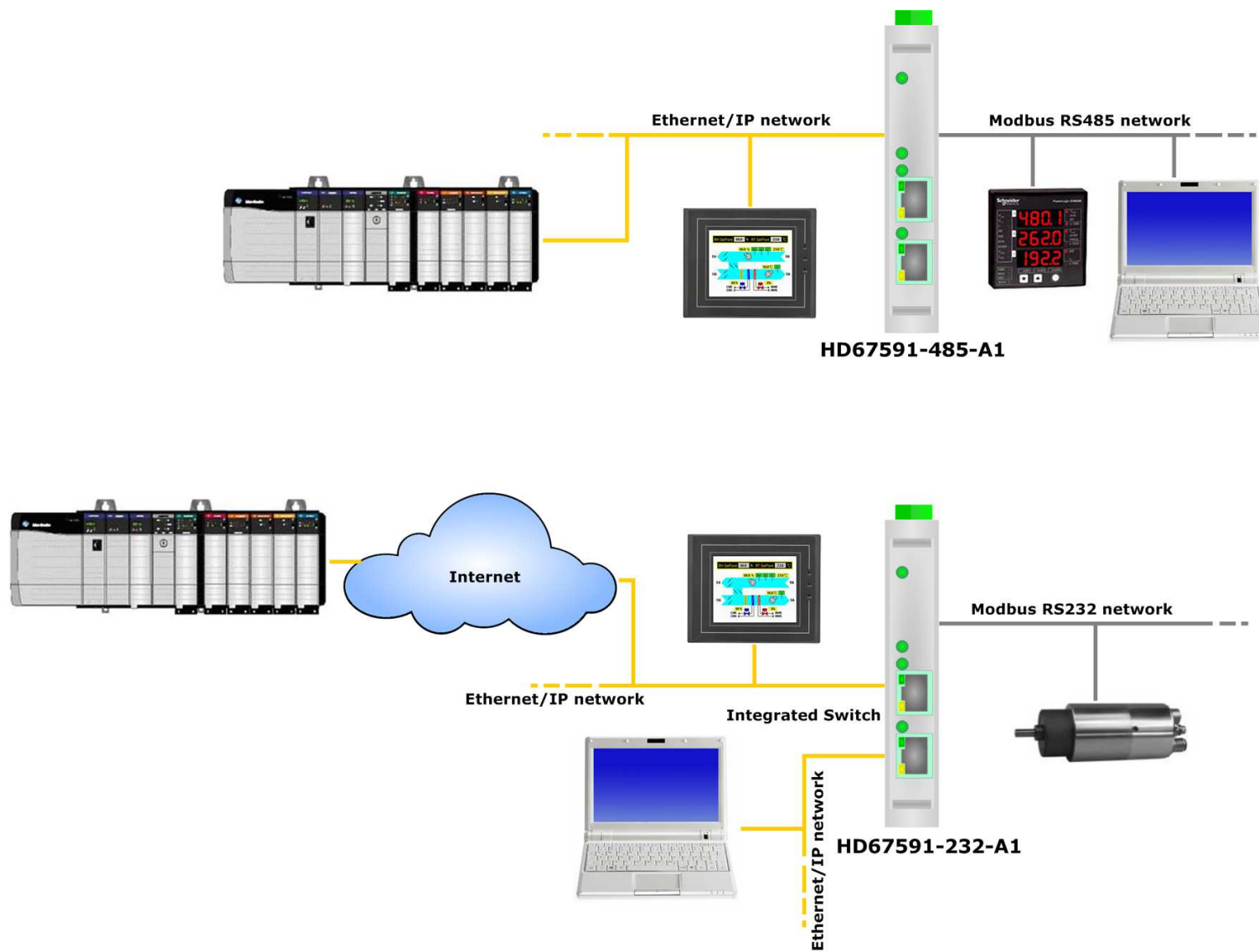

CONNECTION SCHEME:

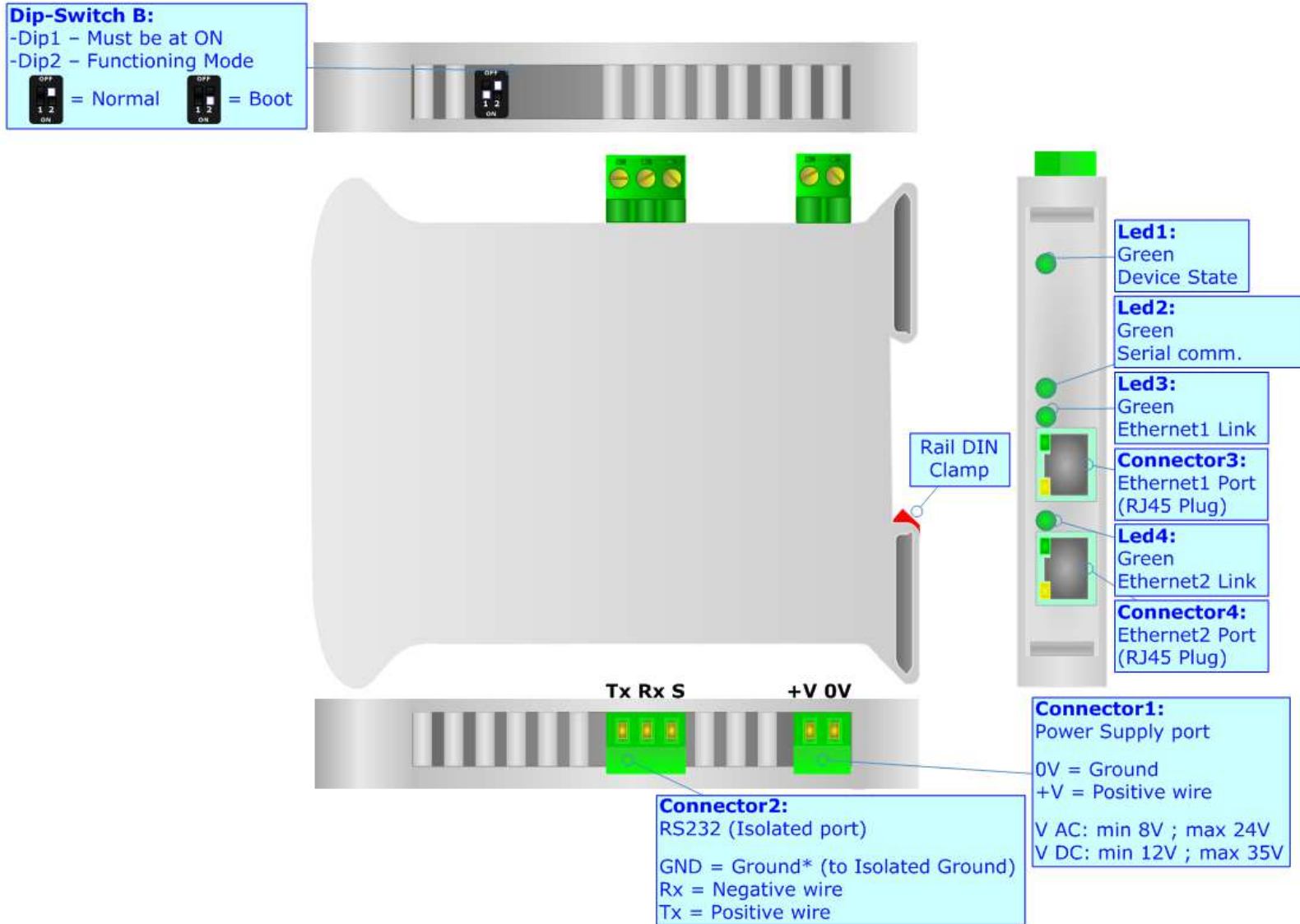

Figure 1a: Connection scheme for HD67591-232-A1

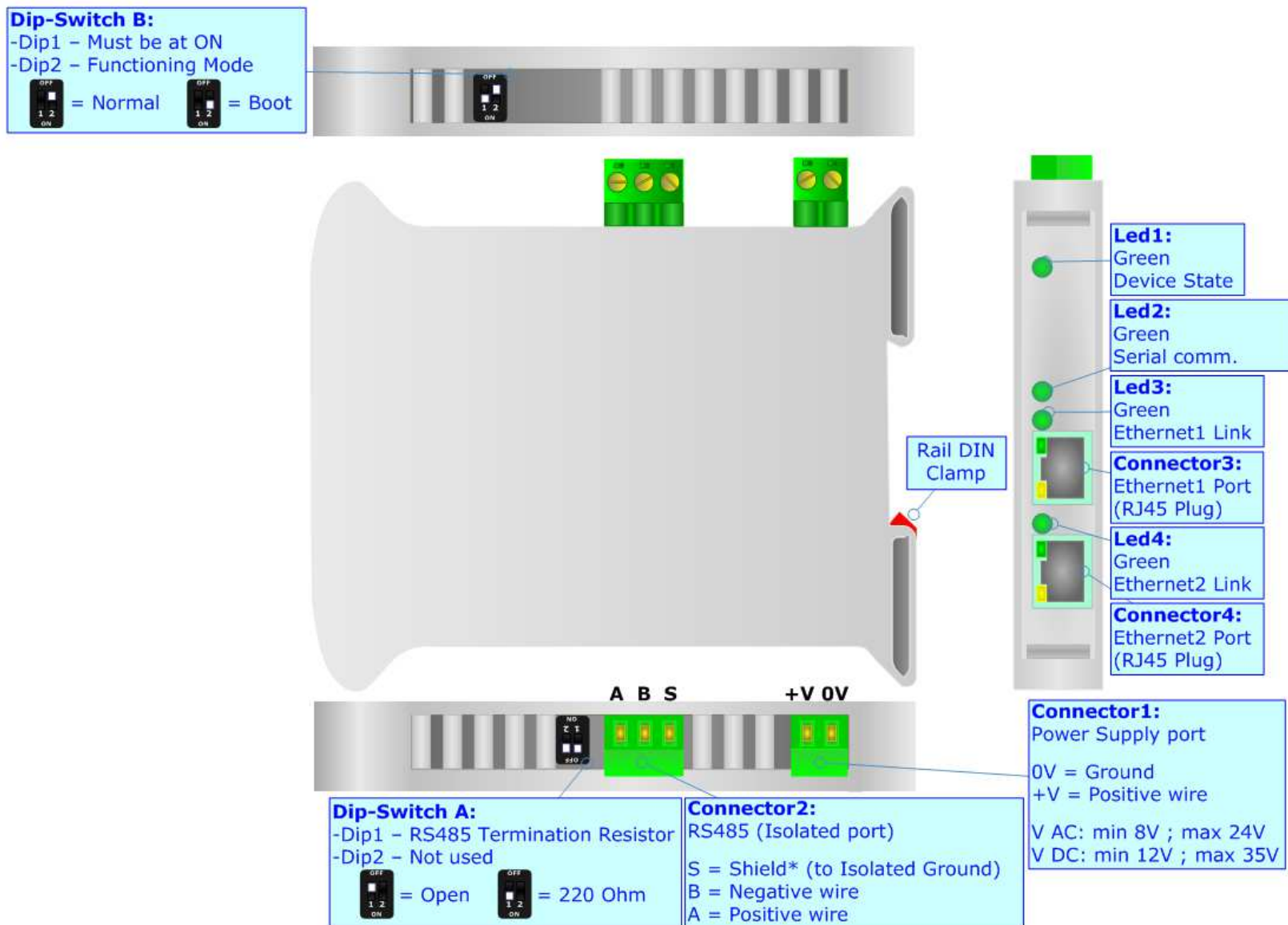

Figure 1b: Connection scheme for HD67591-485-A1

CHARACTERISTICS:

The HD67591-232-A1 and HD67591-485-A1 are a Ethernet/IP / Modbus Master Converter.

It allows the following characteristics:

- Up to 500 bytes in reading and 500 bytes in writing;
- Two-directional information between Modbus bus and Ethernet/IP bus;
- Mountable on 35mm Rail DIN;
- Power Supply 8...24V AC or 12...35V DC;
- Temperature range -40°C to 85°C.

CONFIGURATION:

You need Compositor SW67591 software on your PC in order to perform the following:

- Define the parameter of Ethernet/IP line;
- Define the parameter of Modbus line;
- Define the data to Read in Modbus and where to map these information in the EtherNet/IP
- Define the data to Write in Modbus and where to take the information in the EtherNet/IP
- Update the device.

POWER SUPPLY:

The devices can be powered at 8...24V AC and 12...35V DC. For more details see the two tables below.

VAC		VDC	
Vmin	Vmax	Vmin	Vmax
8V	24V	12V	35V

Consumption at 24V DC:

Device	Consumption [W/VA]
HD67591-232-A1	3.5
HD67591-485-A1	3.5

Caution: Not reverse the polarity power

Connector1:
 Power Supply port
 0V = Ground
 +V = Positive wire
 V AC: min 8V ; max 24V
 V DC: min 12V ; max 35V

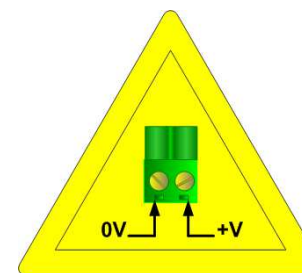

HD67591-xxx-A1

FUNCTION MODES:

The device has got two functions mode depending of the position of the 'Dip2 of Dip-Switch B':

- The first, with 'Dip2 of Dip-Switch B' at "OFF" position, is used for the normal working of the device.
- The second, with 'Dip2 of Dip-Switch B' at "ON" position, is used for upload the Project and/or Firmware.

For the operations to follow for the updating, see 'UPDATE DEVICE' section.

According to the functioning mode, the LEDs will have specifics functions, see 'LEDS' section.

**Warning:**

Dip1 of 'Dip-Switch B' must be at ON position for working even if the Ethernet cable isn't inserted.

LEDS:

The device has got four LEDs that are used to give information of the functioning status.
The various meanings of the LEDs are described in the table below.

LED	Normal Mode	Boot Mode
1: Device State (green)	Blinks slowly (~1Hz)	Blinks quickly: Boot state Blinks very slowly (~0.5Hz): update in progress
2: Serial comm. (green)	Change state when receive a Modbus reply	Blinks quickly: Boot state Blinks very slowly (~0.5Hz): update in progress
3: Ethernet1 Link (green)	ON: Ethernet cable connected OFF: Ethernet cable disconnected	ON: Ethernet cable connected OFF: Ethernet cable disconnected
4: Ethernet2 Link (green)	ON: Ethernet cable connected OFF: Ethernet cable disconnected	ON: Ethernet cable connected OFF: Ethernet cable disconnected

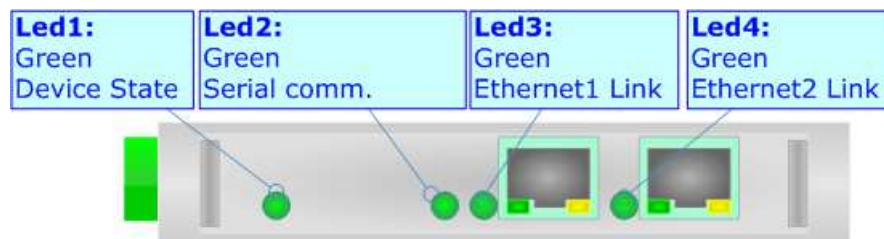

ETHERNET/IP:

The Ethernet/IP connection must be made using Connector3 and/or Connector4 of HD67591-A1 with at least a Category 5E cable. The maximum length of the cable should not exceed 100m. The cable has to conform to the T568 norms relative to connections in cat.5 up to 100 Mbps. To connect the device to an Hub/Switch is recommended the use of a straight cable, to connect the device to a PC/PLC/other is recommended the use of a cross cable.

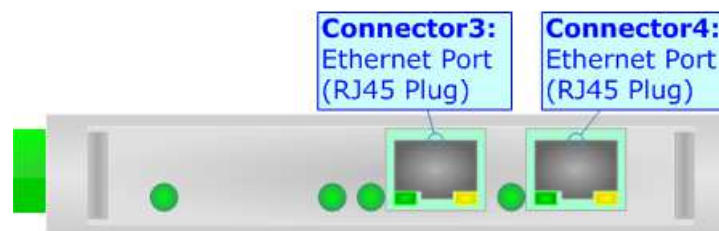

RS485:

For terminate the RS485 line with a 220Ω resistor it is necessary to put ON dip 1, like in figure.

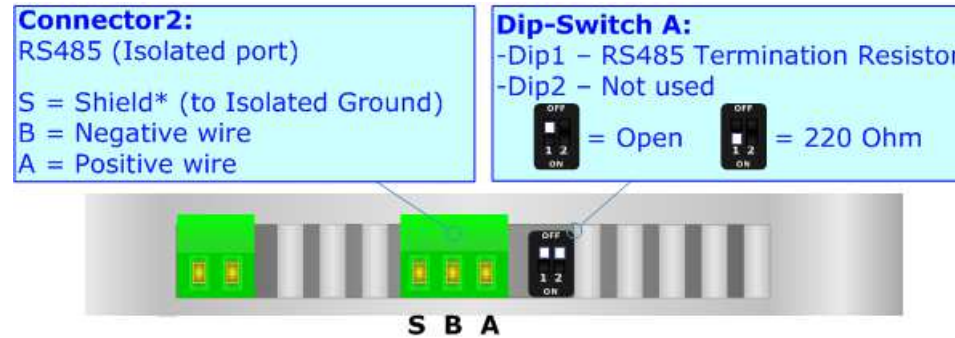

The maximum length of the cable should be 1200m (4000 feet).

Here some codes of cables:

- Belden: p/n 8132 - 2x 28AWG stranded twisted pairs conductor + foil shield + braid shield;
- Belden p/n 82842 - 2x 24AWG stranded twisted pairs conductor + foil shield + braid shield;
- Tasker: p/n C521 - 1x 24AWG twisted pair conductor + foil shield + braid shield;
- Tasker: p/n C522 - 2x 24AWG twisted pairs conductor + foil shield + braid shield.

RS232:

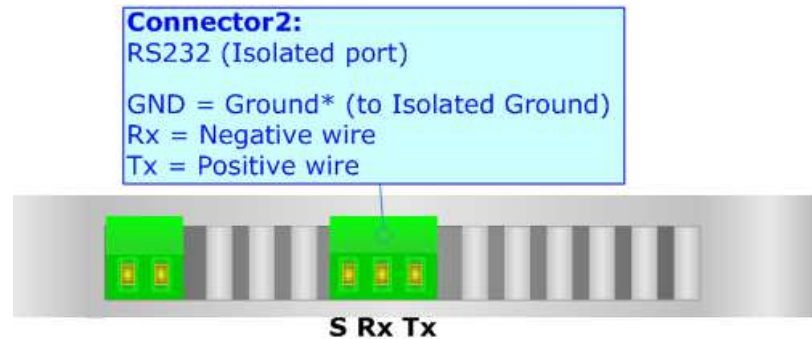

USE OF COMPOSITOR SW67591:

To configure the Converter, use the available software that runs with Windows, called SW67591. It is downloadable on the site www.adfweb.com and its operation is described in this document. *(This manual is referenced to the last version of the software present on our web site).* The software works with MSWindows (MS 2000, XP, Vista, Seven, 8; 32/64bit).

When launching the SW67591 the right window appears (Fig. 2).

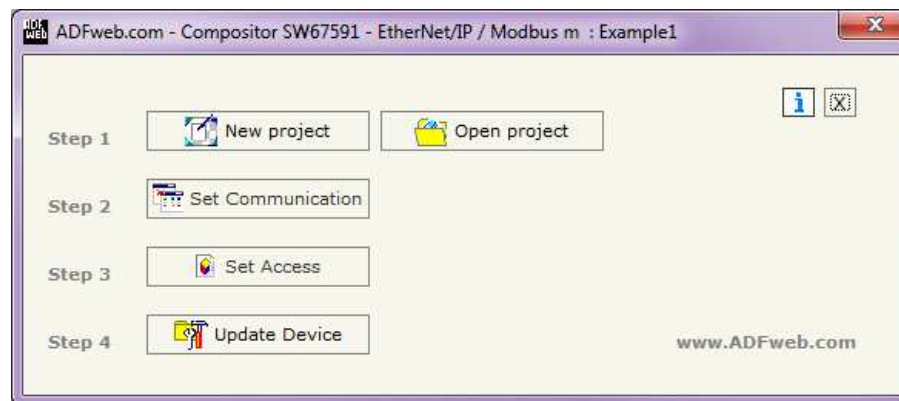

NEW PROJECT / OPEN PROJECT:

The **“New Project”** button creates the folder which contains the entire device configuration.

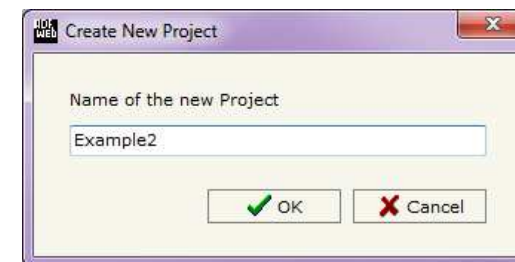
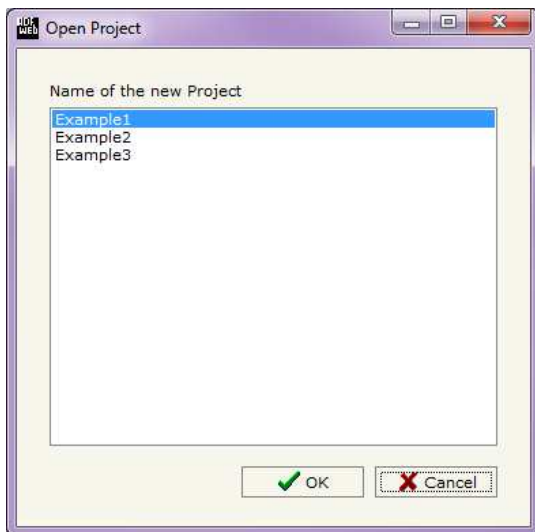

A device configuration can also be imported or exported:

- To clone the configurations of a Programmable “Ethernet/IP / Modbus Master – Converter” in order to configure another device in the same manner, it is necessary to maintain the folder and all its contents;
- To clone a project in order to obtain a different version of the project, it is sufficient to duplicate the project folder with another name and open the new folder with the button **“Open Project”**.

SET COMMUNICATION:

This section define the fundamental communication parameters of two buses, Ethernet/IP and Serial.

By Pressing the "**Set Communication**" button from the main window for SW67591 (Fig. 2) the window "Set Communication" appears (Fig. 3).

The window is divided in two sections, one for the Ethernet/IP and the other for the Serial.

The means of the fields for "Ethernet/IP" are:

- In the fields "**IP**" insert the IP address that you want to give to the Converter;
- In the fields "**SubNet Mask**" insert the SubNet Mask;
- In the fields "**Default Gateway**" insert the default gateway that you want to use. This feature can be enabled or disabled pressing the Check Box field;
- In the field "**Port**" insert the number of port;
- In the field "**Number Byte Input**" the number of byte from the Ethernet/IP to the Converter is defined (at maximum it is possible to use 50 byte);
- In the field "**Number Byte Output**" the number of byte from the Converter to the Ethernet/IP is defined (at maximum it is possible to use 500 byte).

The means of the fields for "Serial" are:

- In the field "**Serial**" the serial to use is defined (RS232 or RS485);
- In the field "**Baud Rate**" the baudrate for the serial line is defined;
- In the field "**Parity**" the parity of the serial line is defined;
- In the field "**TimeOut**" there is the maximum time that the device attends for the answer from the Slave interrogated;
- In the field "**Cyclic Delay**" the delay between two requests is defined;

The screenshot shows a window titled "Set Communication" with a close button (X) in the top right corner. The window is divided into two main sections: "EtherNet/IP" and "Modbus Master".

EtherNet/IP section:

- IP ADDRESS:** Four input fields containing "192", ".168", ".0", and ".10".
- SUBNET Mask:** Four input fields containing "255", ".255", ".255", and ".0".
- GATEWAY:** A checked checkbox followed by four input fields containing "192", ".168", ".0", and ".1".
- Port:** An input field containing "44818".
- Number Byte Input:** An input field containing "500".
- Number Byte Output:** An input field containing "500".

Modbus Master section:

- Serial:** A dropdown menu showing "RS485".
- Baudrate:** A dropdown menu showing "9600".
- Parity:** A dropdown menu showing "NONE".
- TimeOut (ms):** An input field containing "1000".
- Cyclic Delay (ms):** An input field containing "100".

At the bottom of the window, there are two buttons: "OK" (with a green checkmark icon) and "Cancel" (with a red X icon).

Figure 3: "Set Communication" window

SET ACCESS:

By pressing the **"Set Access"** button from the main window for SW67591 (Fig. 2) the window "Set SDO Access" appears.

This window is divided in two parts, the "Modbus Read" (Fig. 4) and the "Modbus Write" (Fig. 5).

The first part ("Modbus Read") is used to read the data that arrived from the Ethernet/IP.

The second part ("Modbus Write") is used to write the data that will be sent to the Slave Ethernet/IP.

Modbus Read

The means of the fields are:

- In the field **"Slave ID"** the address of the Modbus device you have to read is defined;
- In the field **"Type"** insert the data type of the register you would like to read. You can choose between the following:
 - Coil Status;
 - Input Status
 - Holding Register;
 - Input Register.
- In the field **"Address"** the start address of the register to be read is defined;
- In the field **"NPoint"** insert the number of consecutive registers to be read;
- In the field **"Poll Time"** insert the time to make this request;
- In the field **"Max Error"** is the number of errors continues that the gateway waits before suspending the poll until the next reboot. If is set to zero this function is disabled;
- In the field **"Position"** insert the address of the EtherNet/IP array where place the information;
- In the field **"Start Bit"** insert the start bit of the first byte of the field "Position" where start to insert the data read. Valid only for the "Coil Status" and "Input Status".
- In the field **"Mnemonic"** the description for the request is defined.

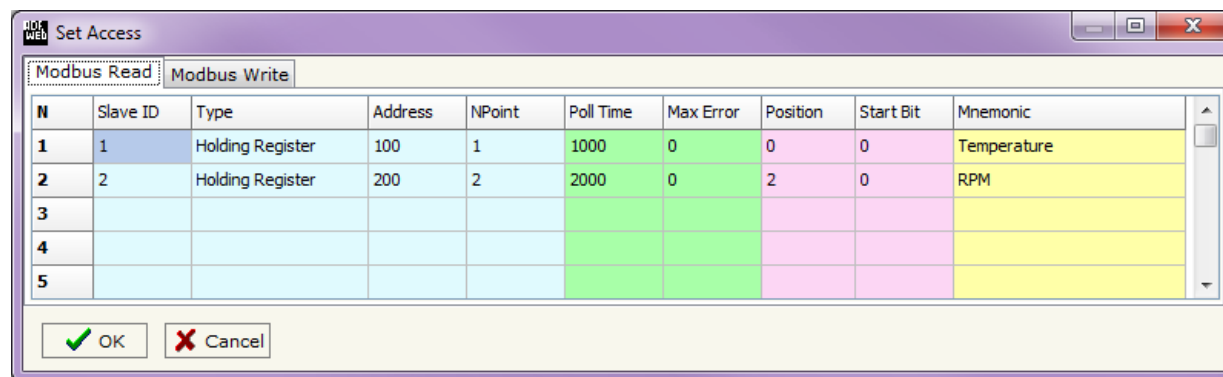

Figure 4: "Set SDO Access / IN --> Serial Read" window

Modbus Write

The means of the fields are:

- In the field "**Slave ID**" the address of the Modbus device that you must write is defined;
- In the field "**Type**" insert the data type of the register you would like to read. You can choose between the following:
 - Coil Status;
 - Holding Register;
- In the field "**Address**" the start address of the register to be written is defined;
- In the field "**NPoint**" insert the number of consecutive registers to be written;
- In the field "**Poll Time**" insert the time to make this request;
- If the field "**On Change**" is checked, the gateway send the Write request in Modbus when the data change the value.
- In the field "**Max Error**" is the number of errors continues that the gateway waits before suspending the poll until the next reboot. If is set to zero this function is disabled;
- In the field "**Position**" insert the address of the EtherNet/IP array where read the information;
- In the field "**Start Bit**" insert the start bit of the first byte of the field "Position" where start to read the data to write. Valid only for the "Coil Status".
- In the field "**Mnemonic**" the description for the request is defined.

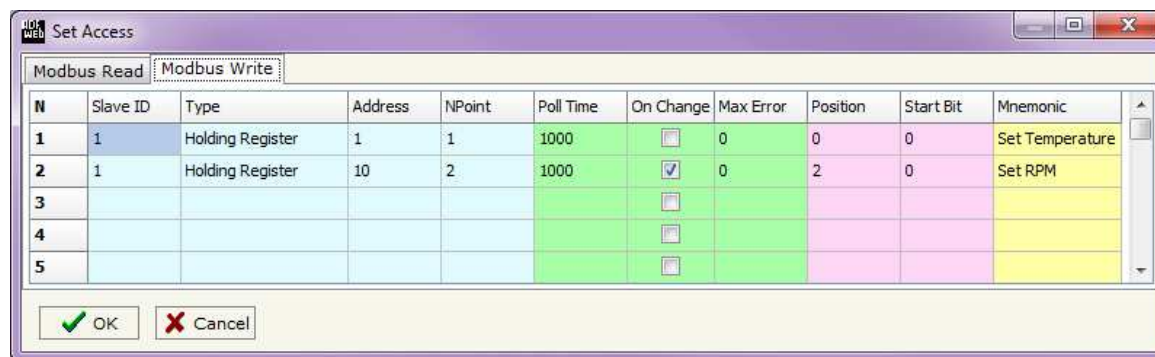

Figure 5: "Set SDO Access / Serial Write --> OUT" window

UPDATE DEVICE VIA UDP:

By pressing the **“Update Device via UDP”** button it is possible to load the created Configuration into the device; and also the Firmware, if is necessary.

If you don't know the actual IP address of the device you have to use this procedure:

- Turn off the Device;
- Put Dip2 of 'Dip-Switch B' at ON position;
- Turn on the device
- Connect the Ethernet cable;
- Insert the IP **“192.168.2.205”**;
- Press the **“Ping”** button, must appear **“Device Found!”**;
- Press the **“Next”** button;
- Select which operations you want to do;
- Press the **“Execute update firmware”** button to start the upload;
- When all the operations are **“OK”** turn off the Device;
- Put Dip2 of 'Dip-Switch B' at OFF position;
- Turn on the device.

At this point the configuration/firmware on the device is correctly updated.

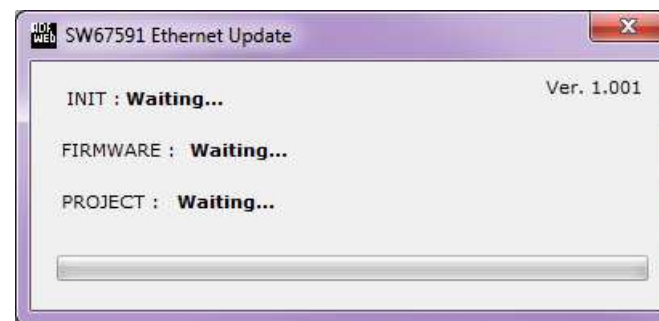
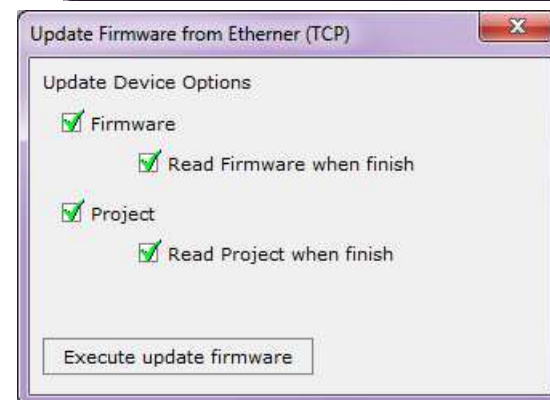
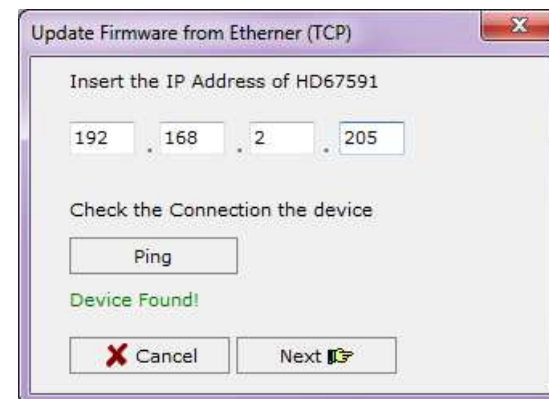



Figure 6: "Update device" windows

If you know the actual IP address of the device you have to use this procedure:

- Turn on the Device with the Ethernet cable inserted;
- Insert the actual IP of the Converter;
- Press the "**Ping**" button, must appear "Device Found!";
- Press the "**Next**" button;
- Select which operations you want to do;
- Press the "**Execute update firmware**" button to start the upload;
- When all the operations are "OK" the device automatically goes at Normal Mode.

At this point the configuration/firmware on the device is correctly update.

 Note:
When you install a new version of the software it is better if the first time you do the update of the Firmware in the HD67591-232-A1 or HD67591-485-A1 device.

 Note:
When you receive the device, for the first time, you have to update also the Firmware in the HD67591-232-A1 or HD67591-485-A1 device.

 Warning:
If the Fig. 7 appears when you try to do the Update before require assistance try these points:

- Try to repeat the operations for the updating;
- Try with another PC;
- Try to restart the PC;
- If you are using the program inside a Virtual Machine, try to use in the main Operating System;
- If you are using Windows Seven or Vista or 8, make sure that you have the administrator privileges;
- Take attention at Firewall lock;
- Check the LAN settings.



Figure 7: "Protection" window

 In the case of HD67591-232-A1 or HD67591-485-A1 you have to use the software "SW67591":
www.adfweb.com/download/filefold/SW67591.zip.

MECHANICAL DIMENSIONS:

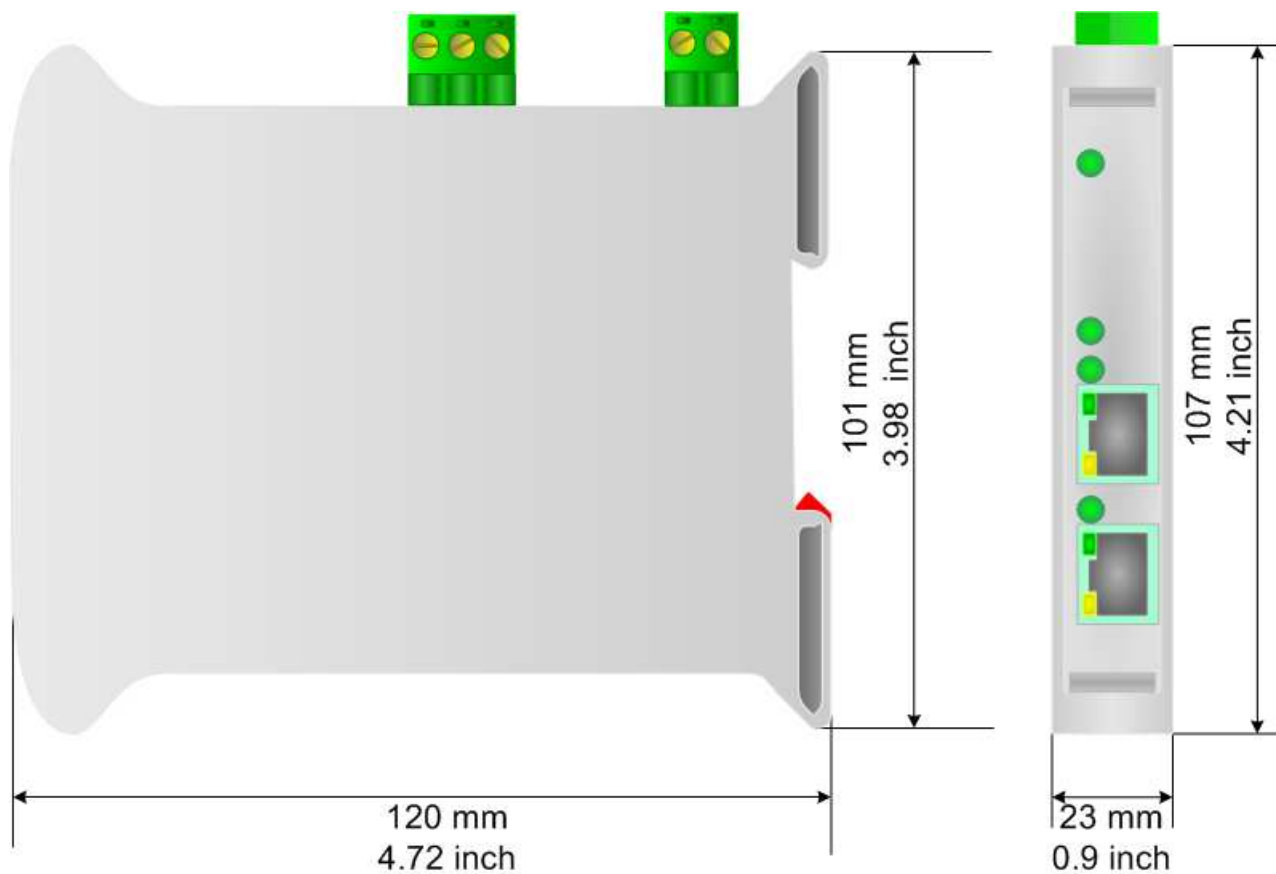

Housing: PVC
Weight: 200g (Approx)

Figure 10: Mechanical dimensions scheme for HD67591-232-A1 and HD67591-485-A1

ORDERING INFORMATIONS:

The ordering part number is formed by a valid combination of the following:

HD67591 - 232 - A 1

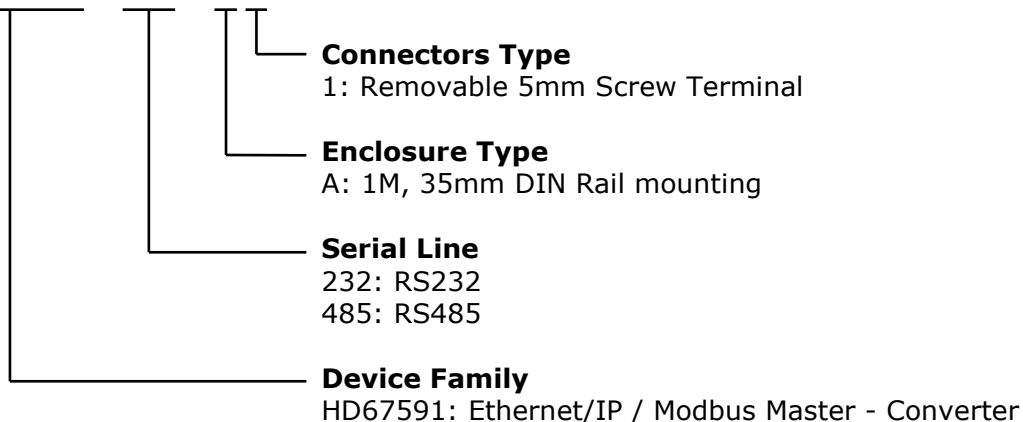

Order Code: **HD670591-232-A1-** Converter Ethernet/IP / Modbus Master Converter (RS232 serial)

Order Code: **HD670591-485-A1-** Converter Ethernet/IP / Modbus Master Converter (RS485 serial)

ACCESSORIES:

Order Code: **AC34001** - 35mm Rail DIN - Power Supply 220/240V AC 50/60Hz - 12 V AC

Order Code: **AC34002** - 35mm Rail DIN - Power Supply 110V AC 50/60Hz - 12 V AC

DISCLAIMER

All technical content within this document can be modified without notice. The content of the document content is a recurring audit. For losses due to fire, earthquake, third party access or other accidents, or intentional or accidental abuse, misuse, or use under abnormal conditions repairs are charged to the user. ADFweb.com S.r.l. will not be liable for accidental loss of use or inability to use this product, such as loss of business income. ADFweb.com S.r.l. shall not be liable for consequences of improper use.

OTHER REGULATIONS AND STANDARDS

WEEE INFORMATION



Disposal of old electrical and electronic equipment (as in the European Union and other European countries with separate collection systems).

— This symbol on the product or on its packaging indicates that this product may not be treated as household rubbish. Instead, it should be taken to an applicable collection point for the recycling of electrical and electronic equipment. If the product is disposed correctly, you will help prevent potential negative environmental factors and human health, which could otherwise be caused by inappropriate disposal. The recycling of materials will help to conserve natural resources. For more information about recycling this product, please contact your local city office, your household waste disposal service or the shop where you purchased the product.

RESTRICTION OF HAZARDOUS SUBSTANCES DIRECTIVE



The device respects the 2002/95/EC Directive on the restriction of the use of certain hazardous substances in electrical and electronic equipment (commonly referred to as Restriction of Hazardous Substances Directive or RoHS).

CE MARKING



The product conforms with the essential requirements of the applicable EC directives.

WARRANTIES AND TECHNICAL SUPPORT:

For fast and easy technical support for your ADFweb.com SRL products, consult our internet support at www.adfweb.com. Otherwise contact us at the address support@adfweb.com

RETURN POLICY:

If while using your product you have any problem and you wish to exchange or repair it, please do the following:

- 1) Obtain a Product Return Number (PRN) from our internet support at www.adfweb.com. Together with the request, you need to provide detailed information about the problem.
- 2) Send the product to the address provided with the PRN, having prepaid the shipping costs (shipment costs billed to us will not be accepted).

If the product is within the warranty of twelve months, it will be repaired or exchanged and returned within three weeks. If the product is no longer under warranty, you will receive a repair estimate.

PRODUCTS AND RELATED DOCUMENTS:

Part	Description	URL
HD67120	Converter Ethernet to RS232/RS485	www.adfweb.com?product=HD67120
HD67119	Converter USB 2.0 to RS485 Isolated	www.adfweb.com?product=HD67119
HD67507	Gateway Modbus TCP Server to RTU Master	www.adfweb.com?product=HD67507
HD67510	Gateway Modbus TCP Client to RTU Slave	www.adfweb.com?product=HD67510