

User Manual

Revision 1.011
English

Modbus Slave / M-Bus Master – Converter (M-Bus Master port: RS232 or RS485, Modbus Slave port: RS232 or RS485)

Benefits and Main Features:

- ▶ Very easy to configure
- ▶ Electrical isolation
- ▶ Industrial temperature range:
-40°C / 85°C (-40°F / 185°F)



HD67055

Similar
Products

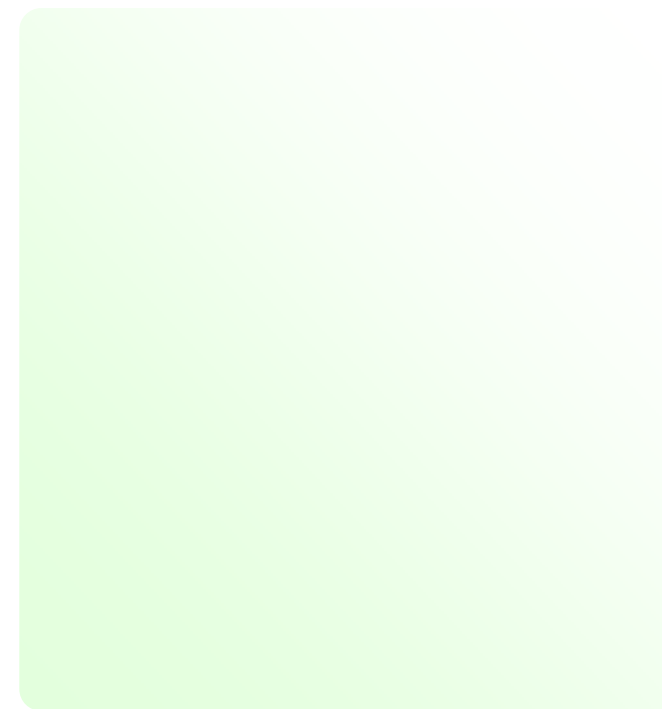
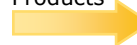

INDEX:

	Page
INDEX	2
UPDATED DOCUMENTATION	2
REVISION LIST	2
WARNING	2
TRADEMARKS	2
SECURITY ALERT	3
EXAMPLE OF CONNECTION	4
CONNECTION SCHEME	5
CHARACTERISTICS	6
CONFIGURATION	6
POWER SUPPLY	7
FUNCTION MODES	8
LEDS	9
RS485 PORT (MODBUS)	10
RS485 PORT (M-BUS)	10
RS232 PORT	11
USE OF COMPOSITOR SW67055	12
NEW PROJECT / OPEN PROJECT	12
SET COMMUNICATION	13
M-BUS	14
UPDATE DEVICE	26
MECHANICAL DIMENSIONS	28
ORDER CODES	28
ACCESSORIES	28
DISCLAIMER	29
OTHER REGULATIONS AND STANDARDS	29
WARRANTIES AND TECHNICAL SUPPORT	30
RETURN POLICY	30
PRODUCTS AND RELATED DOCUMENTS	30

UPDATED DOCUMENTATION:

Dear customer, we thank you for your attention and we remind you that you need to check that the following document is:

- Updated
- Related to the product you own

To obtain the most recently updated document, note the "document code" that appears at the top right-hand corner of each page of this document.

With this "Document Code" go to web page www.adfweb.com/download/ and search for the corresponding code on the page. Click on the proper "Document Code" and download the updates.

To obtain the updated documentation for the product that you own, note the "Document Code" (Abbreviated written "Doc. Code" on the label on the product) and download the updated from our web site www.adfweb.com/download/

REVISION LIST:

Revision	Date	Author	Chapter	Description
1.000	30/10/2009	Fl	All	First release version
1.001	06/07/2010	Ft	All	Revision
1.010	19/06/2012	Fl	All	Software changed (v1.100)
1.011	18/02/2013	Nt	All	Added new chapters

WARNING:

ADFweb.com reserves the right to change information in this manual about our product without warning.
ADFweb.com is not responsible for any error this manual may contain.

TRADEMARKS:

All trademarks mentioned in this document belong to their respective owners.

SECURITY ALERT:**GENERAL INFORMATION**

To ensure safe operation, the device must be operated according to the instructions in the manual. When using the device are required for each individual application, legal and safety regulation. The same applies also when using accessories.

INTENDED USE

Machines and systems must be designed so the faulty conditions do not lead to a dangerous situation for the operator (i.e. independent limit switches, mechanical interlocks, etc.).

QUALIFIED PERSONNEL

The device can be used only by qualified personnel, strictly in accordance with the specifications. Qualified personnel are persons who are familiar with the installation, assembly, commissioning and operation of this equipment and who have appropriate qualifications for their job.

RESIDUAL RISKS

The device is state of the art and is safe. The instrument can represent a potential hazard if they are inappropriately installed and operated by personnel untrained. These instructions refer to residual risks with the following symbol:

 This symbol indicates that non-observance of the safety instructions is danger for people to serious injury or death and / or the possibility of damage.

CE CONFORMITY

The declaration is made by us. You can send an email to or give us a call if you need it.

EXAMPLE OF CONNECTION:

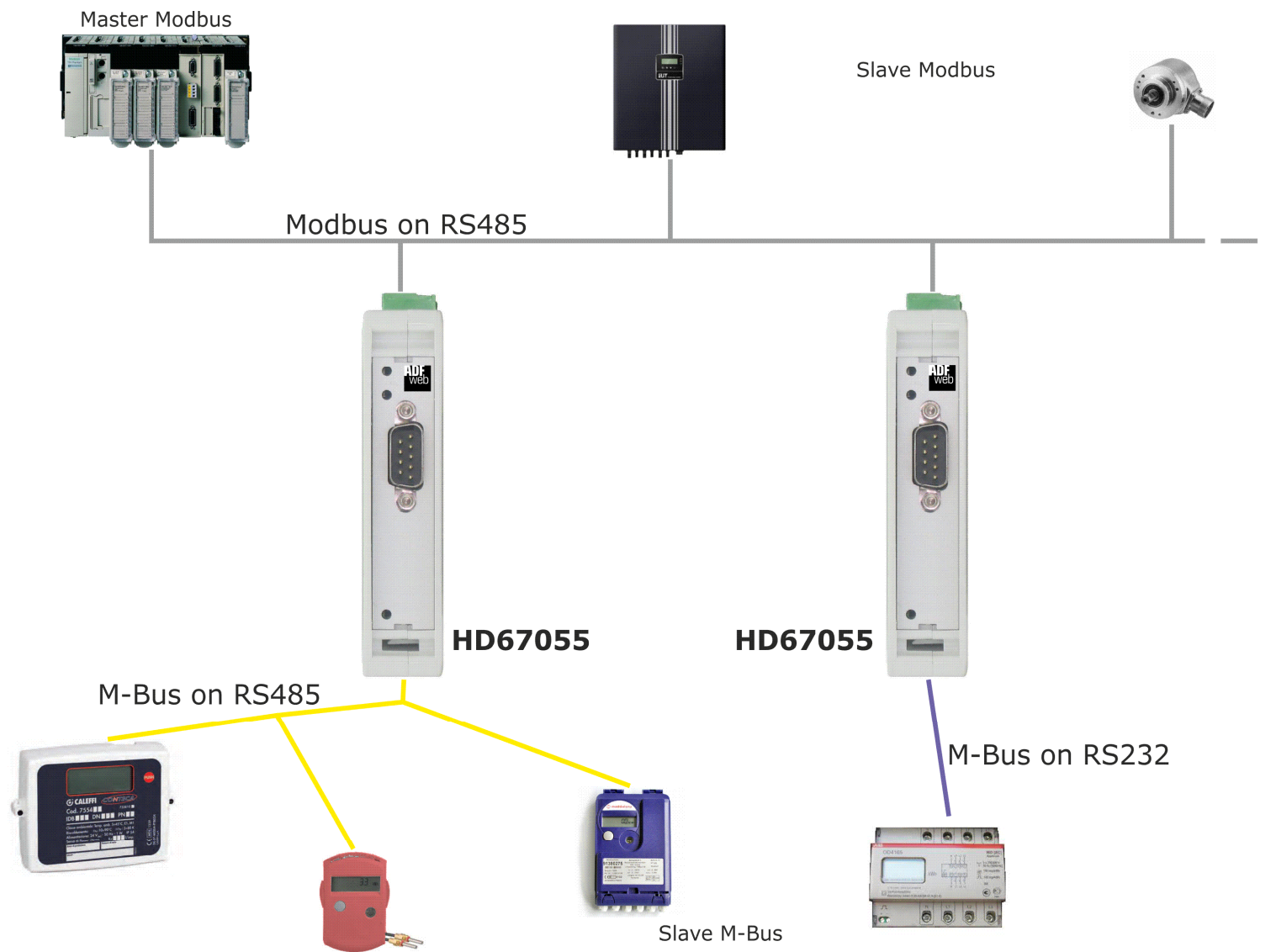

CONNECTION SCHEME:

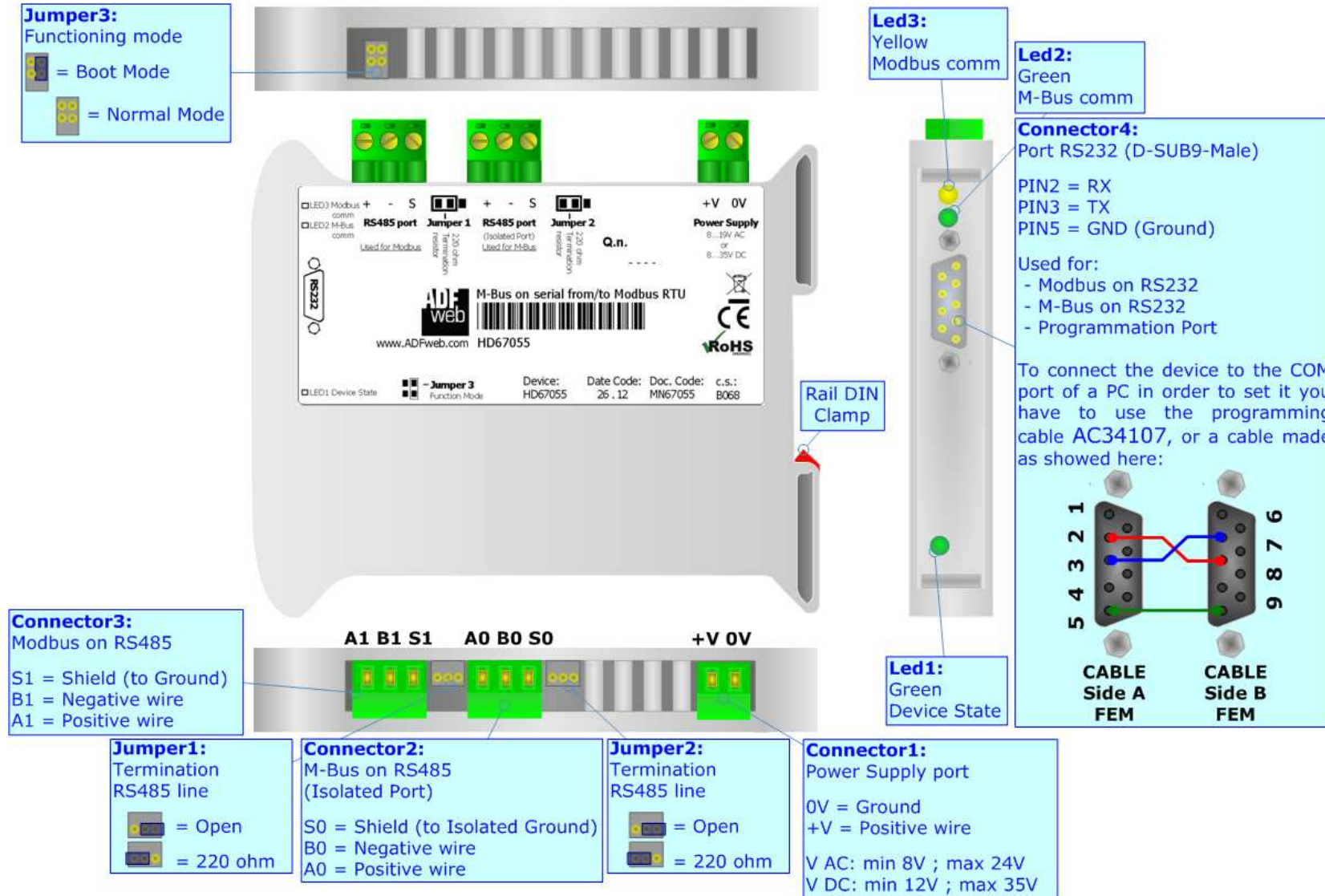

Figure 1: Connection scheme for HD67055

CHARACTERISTICS:

The HD67055 is Gateway that use M-Bus protocol over RS232/RS485 and Modbus RTU/ASCII over RS232/RS485. It allows the following characteristics:

- Electrical isolation between RS232/RS485 and M-Bus on RS485;
- Mountable on Rail DIN;
- Temperature range -40°C to 85°C.



CONFIGURATION:

You need Compositor SW67055 software on your PC in order to perform the following:

- Define the parameter of Modbus line;
- Define the parameter of M-Bus line;
- Define which Modbus register contain the M-Bus information;
- Update the device.

POWER SUPPLY:

The device can be powered between a wide range of tensions. For more details see the two tables below.

VAC 		VDC 	
Vmin	Vmax	Vmin	Vmax
8V	19V	8V	35V

Consumption at 24V DC:

Device	W/VA
HD67055	4



Caution: Not reverse the polarity power

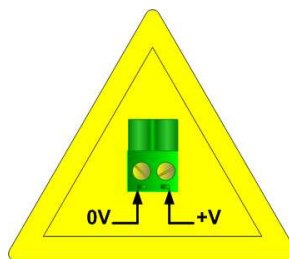

HD67055

Connector1:
 Power Supply port
 0V = Ground
 +V = Positive wire
 V AC: min 8V ; max 24V
 V DC: min 12V ; max 35V



FUNCTION MODES:

The device has got two functions mode depending of the position of 'Jumper3':

- The first, with 'Jumper3' not inserted (factory setting), is used for the normal working of the device.
- The second, with 'Jumper3' inserted, is used for upload the Project/Firmware.

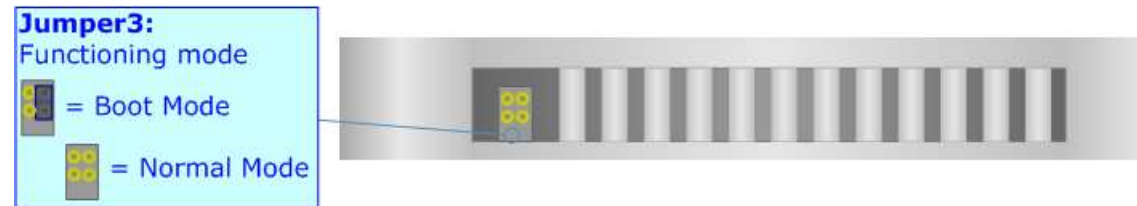

For the operations to follow for the updating (see 'UPDATE DEVICE' section).

According to the functioning mode, the LEDs will have specific functions (see 'LEDS' section).

LEDS:

The device has got three LEDs that are used to give information of the functioning status. The various meanings of the LEDs are described in the table below.

LED	Normal Mode	Boot Mode
1: Device State (green)	Blinks slowly (~1Hz)	Blinks quickly
2: M-Bus comm (green)	Blinks quickly when receive a M-Bus response	Off
3: Modbus comm (green)	Change state when receive a correct Modbus request	Off



RS485 PORT (MODBUS):

For terminate the RS485 line with a 220Ω resistor it is necessary that the 'Jumper1' is like the label over the device.

The maximum length of the cable should be 1200m (4000 feet).

Here some codes of cables:

- Belden: p/n 8132 - 2x 28AWG stranded twisted pairs conductor + foil shield + braid shield;
- Belden p/n 82842 - 2x 24AWG stranded twisted pairs conductor + foil shield + braid shield;
- Tasker: p/n C521 - 1x 24AWG twisted pair conductor + foil shield + braid shield;
- Tasker: p/n C522 - 2x 24AWG twisted pairs conductor + foil shield + braid shield.

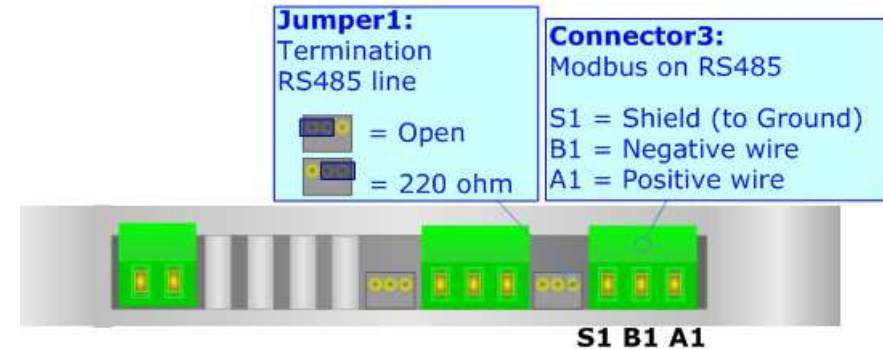

RS485 PORT (M-BUS):

For terminate the RS485 line with a 220Ω resistor it is necessary that the 'Jumper2' is like the label over the device.

The maximum length of the cable should be 1200m (4000 feet).

Here some codes of cables:

- Belden: p/n 8132 - 2x 28AWG stranded twisted pairs conductor + foil shield + braid shield;
- Belden p/n 82842 - 2x 24AWG stranded twisted pairs conductor + foil shield + braid shield;
- Tasker: p/n C521 - 1x 24AWG twisted pair conductor + foil shield + braid shield;
- Tasker: p/n C522 - 2x 24AWG twisted pairs conductor + foil shield + braid shield.

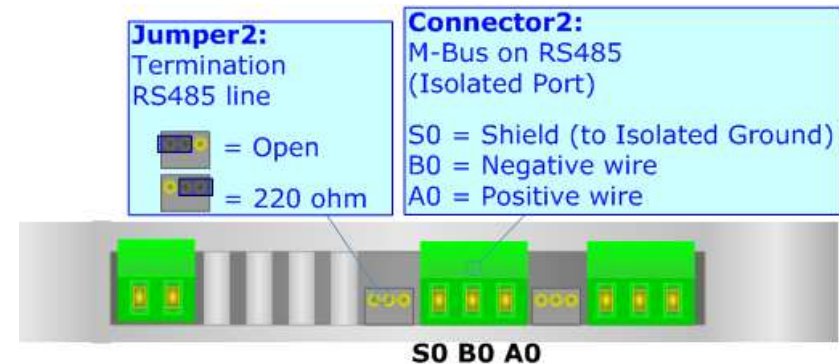

RS232 PORT:

The connection from RS232 socket to a serial port (example one from a personal computer), must be made with a Null Modem cable (a serial cable where the pins 2 and 3 are crossed). It is recommended that the RS232C Cable not exceed 15 meters.

The serial port is used for programming the device or for Modbus communication.

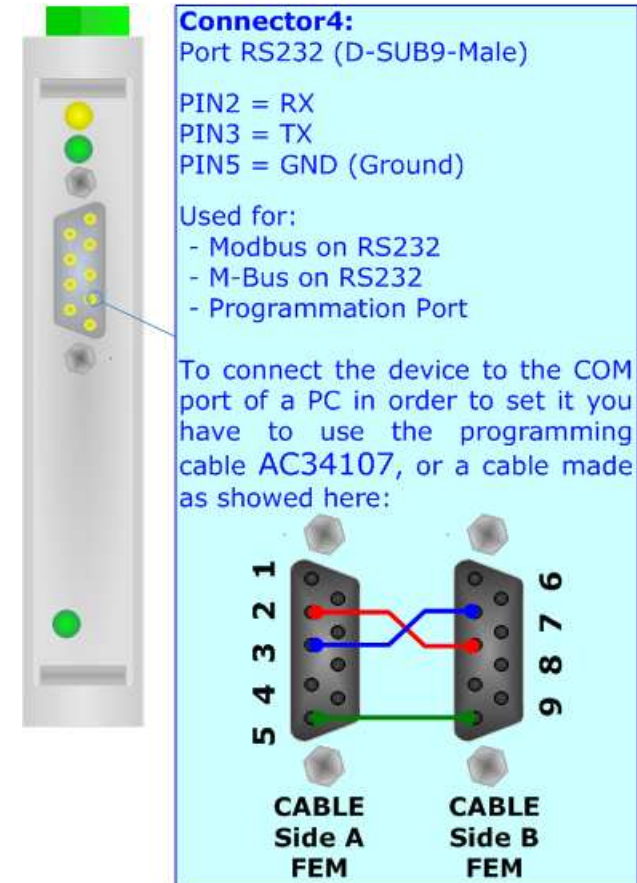

USE OF COMPOSITOR SW67055:

To configure the Gateway, use the available software that runs with Windows, called SW67055. It is downloadable on the site www.adfweb.com and its operation is described in this document.

When launching the SW67055 the right window appears (Fig. 2).

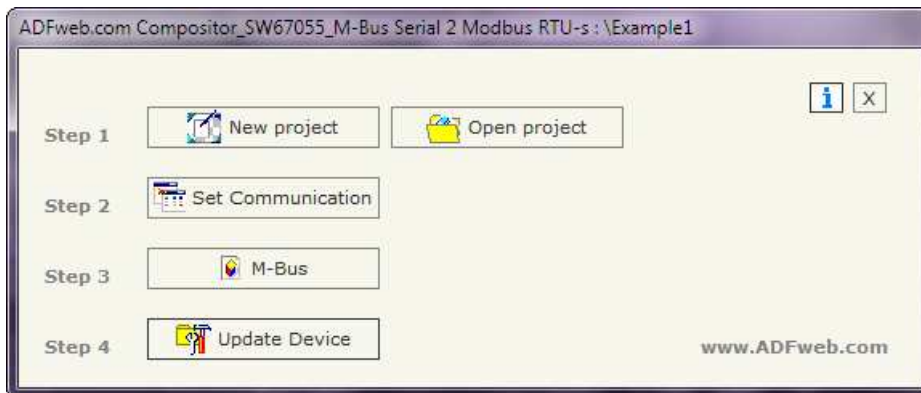

Figure 2: Main window for SW67055

NEW PROJECT / OPEN PROJECT:

The **"New Project"** button creates the folder which contains the entire device configuration.



A device configuration can also be imported or exported:

- To clone the configurations of a Programmable M-Bus to Modbus Gateway in order to configure another device in the same manner, it is necessary to maintain the folder and all its contents;
- To clone a project in order to obtain a different version of the project, it is sufficient to duplicate the project folder with another name and open the new folder with the button **"Open Project"**.

SET COMMUNICATION:

This section define the fundamental communication parameters of two Buses, Modbus and M-Bus.

By Pressing the “**Set Communication**” button from the main window for SW67055 (Fig. 2) the window “Set Communication” appears (Fig. 3).

The window is divided in two sections, one for the Modbus RTU line (Serial) and the other for the M-Bus.

It is possible to configure the serials port between these options:

- Modbus RTU (Serial) on RS232 & M-Bus on RS485;
- Modbus RTU (Serial) on RS485 & M-Bus on RS485;
- Modbus RTU (Serial) on RS485 & M-Bus on RS232.

The means of the fields for Serial are:

- In the field “**Baudrate**” the baudrate of the serial line in use is defined;
- In the field “**Parity**” the parity of the serial line is defined;
- In the field “**ID Dev.**” the ID assigned to the Gateway, for the Modbus side, is defined.
- In the subsection “Protocol” it is possible to select the protocol to use in Modbus line from the following:
 - **Modbus RTU**;
 - **Modbus ASCII**;
 - **JBUS**;
 - **Binary**: simple protocol defined by Us, whose functions are described in the document “Simple Protocol” downloadable at www.adfweb.com/download/filefold/Simple_Protocol_ENG.pdf ;
 - **ASCII**: simple protocol defined by Us, whose functions are described in the document “Simple Protocol” downloadable at www.adfweb.com/download/filefold/Simple_Protocol_ENG.pdf .

The means of the fields for M-Bus are:

- In the field “**Baudrate**” the baudrate of the M-Bus line in use is defined;
- In the field “**Parity**” the parity of the M-Bus line is defined;
- If the field “**M-Bus Poll on request**” is checked, the Gateway makes the request only if a Modbus register is requested; otherwise if “**Cyclic request**” is checked, the Gateway makes the request in M-bus network each time the time defined under passes;
- In the field “**Delay**” insert a time expressed in seconds. This time is used for the “Cyclic request”.

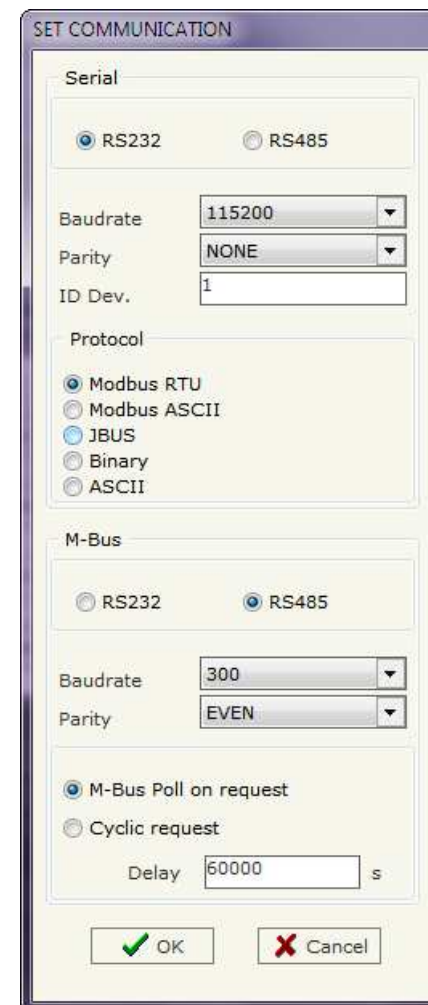

Figure 3: “Set Communication” window

M-BUS

By Pressing the “**M-Bus**” button from the main window for SW67029 (Fig. 2) the window “M-Bus Network” appears (Fig. 4).

SECTION NODES:

In the section “Nodes” it is possible to create the nodes of M-Bus line. In order to create a new node it is necessary to select which address use, selecting “**Primary ID**” or “**Secondary ID**”, to makes the requests and then insert the “Primary Address” (from 1 to 250) or the Secondary Address” (from 0 to 99999999) of M-Bus device in the field “**ID Node M-Bus**”. In the field “**Description**” it is possible to write a short description of the node.

In the field “**Node State**” it is possible to insert an address Modbus that contain the Status of the M-Bus device. If you don’t need to know this, put this register at 0.

In the field “**Identification Number**” it is possible to insert an address Modbus that contain the Identification Number of the M-Bus device. You have to read two consecutive registers for knowing the value. If you don’t need to know this, put this register at 0.

If the field “**Convert BCD in Integer Identification Num.**” is checked the gateway converts the Identification Number that is normally expressed in BCD in a Integer.

In the field “**Swap Identification Num.**” it is possible to select the swap mode of the Identification Number. If swap isn’t necessary you have to select “None”; otherwise see the section “Swap Identification” (page 21) of this document for select the swap mode.

If the field “**Send SND_NKE**” is checked, the Gateway send the “SND_NKE” frame to start the communication.

In the field “**Send Reset App.**” Is checked the gateway send the “Application Reset” command to the slave. In the field “**Variables List**” it is possible to select which type of variables definition to use.

If is selected “By Type” it is necessary to fill all fields, in the section Variables, with the correct values; otherwise if “By Position” is selected you can insert the progressive number of the variable that you need (page 15-16 for more information).

After that, pressing the “**ADD NODE**” button, a new node appears in the left side of the window. In order to modify a created node it is necessary to select the desired node, change the wrong items and then press the “**MODIFY NODE**” button.

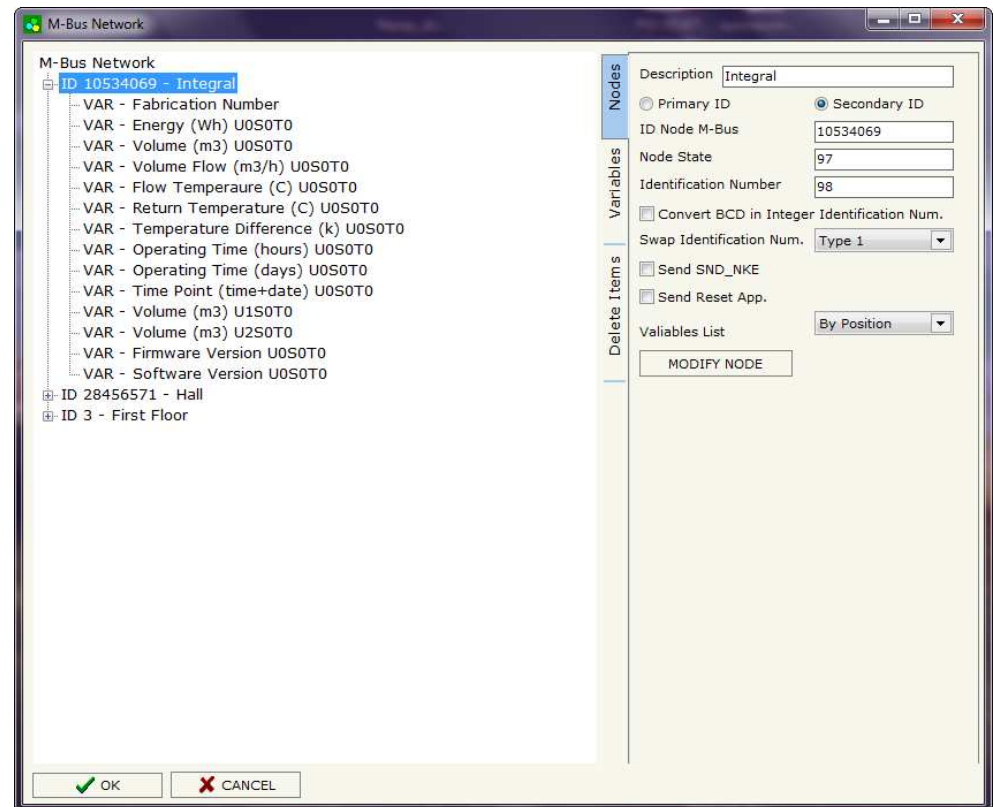
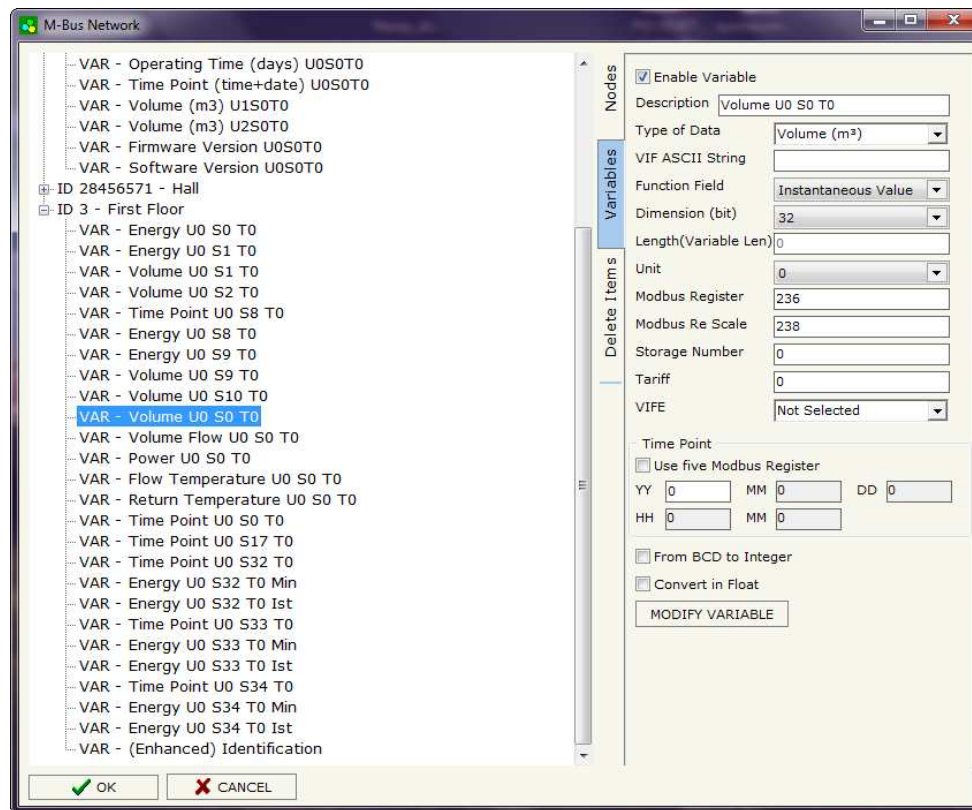

Figure 4: “M-Bus Network” window

SECTION VARIABLES (BY TYPE):

Selecting the desired node it is possible to add a variable. In order to create a new variable it is necessary to fill these items:

- To use the created variable the field **“Enable Variable”** must be checked. If you have created a variable but for the moment it is unused it is possible to uncheck the field **“Enable Variable”** without delete it;
- In the field **“Description”** it is possible to write a description of the variable (it isn't a necessary information, it helps the readability of the tree of network);
- The field **“Type of Data”** is used to select the unit of measure;
- In the field **“VIF ASCII String”** insert the string of VIF. It is possible to use this field only if the **“Type of Data”** is **“VIF is in ASCII”**;
- In the field **“Function Field”** it is necessary to select the type of data;
- The field **“Dimension”** is used to select the dimension of the variable (8, 16, 24, 32, 32 real, 48, 64 bit, Variable Length);
- In the field **“Length(Variable Len)”** insert the length of the data in the case of the dimension is **“Variable Length”**;
- In the field **“Unit”** if it is necessary it is possible to select the unit of that variable. The Unit is used for indicates from which device the data come;
- In the field **“Modbus Register”** it is necessary to insert the value of Modbus Register that contains the data of the M-Bus device. It is possible to insert from Modbus Register **“1”** to **“60000”**;
- In the field **“Modbus Re Scale”** it is necessary to insert the value of Modbus Register that contains the value of measure scale. If the scale is not necessary, you have to insert the number **“0”** in this field. It is possible to insert from Modbus Register **“1”** to **“60000”**;
- In the field **“Storage Number”** if it is necessary it is possible to insert the value of storage counter of that variable. With this field the slave can indicate and transmit various stored counter states or historical values, in the order in which they occur;
- In the field **“Tariff”** if it is necessary it is possible to insert the value of the tariff of that variable. The Tariff is used for indicates from which device the data come;
- In the field **“VIFE”** it is possible to select a sub-type of **“Type of Data”**;



- If the field "**Use Five Modbus Register**" and the "Type of Data" is "Time Point" it is possible to read the information of Year, Month, Day, Hour, Minutes on five consecutive Modbus registers without decoding the data (if not selected the values are the same of the reply of the slave device, so coded with a determinate structure). You have to insert the first Modbus Register.
- If the field "**From BCD to Integer**" is checked the Gateway converts the BCD value of variable in Integer format. This happens only if the variable is in BCD format; if it isn't nothing changes.
- If the field "**Convert in Float**" is checked the Gateway converts the data into Float type. Every variable occupies two consecutive Modbus Registers and the first one is the one defined in "Modbus Register". In this case the float value is multiplied by the "Modbus Re Scale" automatically.

Having completed this fields, to add the variable the button "**ADD VARIABLE**" must be pressed.

In order to modify a created variable it is necessary to select the desired variable, change the wrong items and then press the "**MODIFY VARIABLE**" button.

SECTION VARIABLES (BY POSITION):

Selecting the desired node it is possible to add a variable. In order to create a new variable it is necessary to fill these items:

- To use the created variable the field **"Enable Variable"** must be checked. If you have created a variable but for the moment it is unused it is possible to uncheck the field "Enable Variable" without delete it;
- In the field **"Description"** it is possible to write a description of the variable (it isn't a necessary information, it helps the readability of the tree of network);
- The field **"Dimension"** is used to select the dimension of the variable (8, 16, 24, 32, 32 real, 48, 64 bit, Variable Length);
- In the field **"Length(Variable Len)"** insert the length of the data in the case of the dimension is "Variable Length";
- In the field **"Modbus Register"** it is necessary to insert the value of Modbus Register that contains the data of the M-Bus device. It is possible to insert from Modbus Register "1" to "60000";
- In the field **"Modbus Re Scale"** it is necessary to insert the value of Modbus Register that contains the value of measure scale. If the scale is not necessary, you have to insert the number "0" in this field. It is possible to insert from Modbus Register "1" to "60000";
- If the field **"Use Five Modbus Register"** and the "Type of Data" is "Time Point" it is possible to read the information of Year, Month, Day, Hour, Minutes on five consecutive Modbus registers without decoding the data (if not selected the values are the same of the reply of the slave device, so coded with a determinate structure (page 22 for more information)). You have to insert the first Modbus Register.
- If the field **"From BCD to Integer"** is checked the Gateway converts the BCD value of variable in Integer format. This happens only if the variable is in BCD format; if it isn't nothing changes;
- If the field **"SWAP"** is checked the byte of data of that variable are swapped. Example: from 0x01020304 to 0x04030201;
- In the field **"Position"** insert the number of the variable that you want on Modbus.

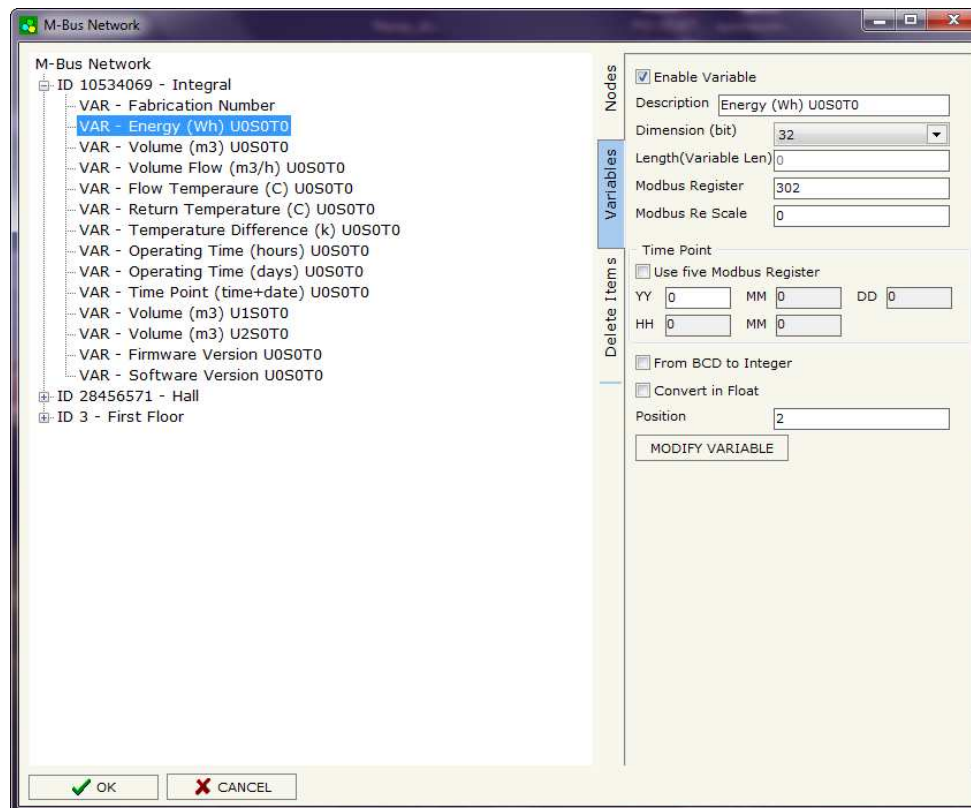

Example:

0x68 - Start Byte
 0xBD - L Fied
 0xBD - L Field
 0x68 - Start Byte
 0x08 - C Field
 0x02 - A Field
 0x72 - CI Field

0x71 - Identification Number (Byte 4of4)
 0x65 - Identification Number (Byte 3of4)
 0x45 - Identification Number (Byte 2of4)
 0x28 - Identification Number (Byte 1of4)
 0x4D - Manufacturer (Byte 2of2)
 0x6A - Manufacturer (Byte 1of2)
 0x81 - Version
 0x04 - Medium
 0x3E - Access Number
 0x27 - Status
 0x00 - Signature (Byte 2of2)
 0x00 - Signature (Byte 1of2)

0x04 - DIF
 0x79 - VIF Identification
 0x00 - Data (Byte 4of4)
 0x00 - Data (Byte 3of4)
 0x00 - Data (Byte 2of4)
 0x00 - Data (Byte 1of4)

0x04 - DIF
 0x06 - VIF Energy
 0x00 - Data (Byte 4of4)
 0x00 - Data (Byte 3of4)
 0x00 - Data (Byte 2of4)
 0x00 - Data (Byte 1of4)

0x44 - DIF
 0x06 - VIF Energy
 0x00 - Data (Byte 4Of4)
 0x00 - Data (Byte 3Of4)
 0x00 - Data (Byte 2Of4)
 0x00 - Data (Byte 1Of4)

... Other Variables
 ...
 0x55 - Check Sum
 0x16 - Stop Byte

Identification Number (or Secondary Address) putted in the selected register if "**Identification Number**" is checked

Fixed Data Header

Status of the meter putted in the selected register if "**Node State**" is checked

First Variable (1)

Second Variable (2)

Third Variable (3)

To be use in the "**Position**" field

SECTION DELETE ITEMS:

If it is necessary to delete a node or a variable, you have to select the node or the variable and then press the **"DELETE ITEM"** button.

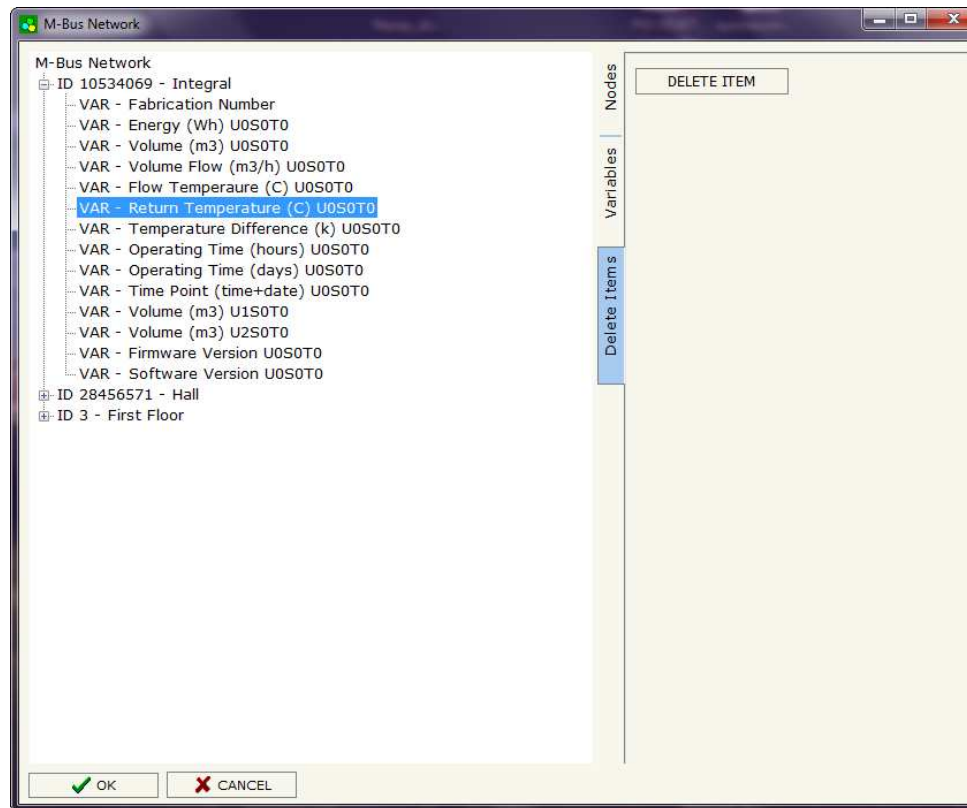

Possible choices for the fields used to create a variable:

Type of Data:

- |_Energy (Wh)
- |_Energy (J)
- |_Volume (m³)
- |_Mass (Kg)
- |_On Time
- |_Operating Time
- |_Power (W)
- |_Power (J/h)
- |_Volume Flow (m³/h)
- |_Volume Flow Ext. (m³/min)
- |_Volume Flow Ext. (m³/s)
- |_Mass Flow (Kg/h)
- |_Flow Temperature (°C)
- |_Return Temperature (°C)
- |_Temperature Difference (K)
- |_External Temperature (°C)
- |_Pressure (bar)
- |_Averaging Duration
- |_Actuality Duration
- |_Type of data in VIFE
- |_Time Point
- |_VIF is in ASCII
- |_Unit for H.C.A.
- |_Fabrication No
- |_(Enhanced) Identification
- |_Bus Address

Function Field:

- |_Instantaneous Value
- |_Minimum Value
- |_Maximum Value
- |_Value During Error State

Dimension (bit):

- |_8
- |_16
- |_24
- |_32
- |_32 real
- |_48
- |_64
- |_Variable Length

VIFE:

- | | |
|---|---|
| <ul style="list-style-type: none"> _ Not Selected _ Credit of the nominal local legal currency units _ Debit of the nominal local legal currency units _ Access Number (transmission count) _ Medium (as in fixed header) _ Manufacturer (as in fixed header) _ Parameter set identification _ Model/Version _ Hardware Version # _ Firmware Version # _ Software Version # _ Customer Location _ Customer _ Access Code User _ Access Code Operator _ Access Code System Operator _ Access Code Developer _ Password _ Error flags (binary) _ Error mask _ Digital Output (binary) _ Digital Input (binary) _ Baudrate [Baud] _ response delay time [bittimes] _ Retry _ First storage # for cyclic storage _ Last storage # for cyclic storage _ Size of storage block _ Storage interval [sec(s)..day(s)] _ Storage interval month(s) _ Storage interval year(s) _ Duration since last readout[sec(s)..day(s)] _ Start (date/time) of tariff _ Duration of tariff (nn=01..11:min to day) _ Period of tariff [sec(s) to day(s)] | <ul style="list-style-type: none"> _ Period of tariff months(s) _ Period of tariff year(s) _ dimensionless/ no VIF _ Volts _ Ampere _ Reset counter _ Comulation counter _ Control signal _ Day of week _ Week number _ Time point of day change _ State of parameter activation _ Special supplier information _ Duration since last comulation [hour(s)..year(s)] _ Operation time battery [hour(s)..year(s)] _ Date and time of battery change _ Energy MWh _ Energy GJ _ Volume _ Mass _ Volume 0,1 feet^3 _ Volume 0,1 american gallon _ Volume 1 american gallon _ Volume flow 0,001 american gallon/min _ Volume flow 1 american gallon/min _ Volume flow 1 american gallon/h _ Power MW _ Power GJ/h _ Flow Temperature _ Return Temperature _ Temperature Difference _ External Temperature _ Cold/Warm Temperature Limit °F _ Cold/Worm Temperature Limit °C _ Cumul. count max power |
|---|---|

- _ per second
- _ per minute
- _ per hour
- _ per day
- _ per week
- _ per month
- _ per year
- _ per revolution/measurement
- _ increment per input pulse on input channel
- _ increment per output pulse on output channel
- _ per liter
- _ per m³
- _ per kg
- _ per K (Kelvin)
- _ per kWh
- _ per GJ
- _ per kW
- _ per (K*I)(Kelvin*liter)
- _ per V (Volt)
- _ per A (Ampere)
- _ multiplied by sek
- _ multiplied by sek/V
- _ multiplied by sek/A
- _ start date(/time) of
- _ VIF contains uncorrected unit instead of corrected unit
- _ Accumulation only if positive contributions
- _ Accumulation of abs value only if negative contributions
- _ upper/lower limit value
- _ # of exceeds of lower/upper limit
- _ Date(/time) of begin/end of first/last lower/upper limit exceed

- _ Duration of limit exceed
- _ Duration of first/last
- _ Date(/time) of first/last begin/end
- _ Multiplicative currection factor
- _ Additive correction constant * unit of VIF (offset)
- _ Multiplicative correction factor: 10³
- _ future value
- _ next VIFE's and data of this block are manufacturer specific
- _ None
- _ Too many DIFE's
- _ Storage number not implemented
- _ Unit number not implemented
- _ Tariff number not implemented
- _ Function not implemented
- _ Data class not implemented
- _ Data size not implemented
- _ Too many VIFE's
- _ Illegal VIF-Group
- _ Illegal VIF-Exponent
- _ VIF/DIF mismatch
- _ Unimplemented action
- _ No data available (undefined value)
- _ Data overflow
- _ Data underflow
- _ Data error
- _ Premature end of record

Swap Identification:

This field is used for select the Swap mode of Identification Number.

At the moment there are these possibilities:

- None;
- Type 1.

Examples:

- Identification Number (Secondary Address): 12345678; Address Register 1000; Convert BCD in Integer Identification Num. not checked.

None	Type 1
1000: 0x1234	1000: 0x5678
1001: 0x5678	1001: 0x1234

- Identification Number (Secondary Address): 12345678; Address Register 1000; Convert BCD in Integer Identification Num. checked.

None	Type 1
1000: 0x00BC	1000: 0x614E
1001: 0x614E	1001: 0x00BC

To know the meaning of value read in the "Modbus Re Scale" field, you must follow this table (x = Value read in Modbus Re Scale):

Description	Range Coding	Range
Energy	$10^{(x-3)}$ Wh	0.001 Wh to 10000 Wh
Energy	$10^{(x)}$ J	0.001 kJ to 10000 kJ
Volume	$10^{(x-6)}$ m ³	0.001 l to 10000 l
Mass	$10^{(x-3)}$ kg	0.001 kg to 10000 kg
On Time	x = 0 Seconds x = 1 Minutes x = 2 Hours x = 3 Days	
Operating Time	coded like On Time	
Power	$10^{(x-3)}$ W	0.001 W to 10000 W
Power	$10^{(x)}$ J/h	0.001 kJ/h to 10000 kJ/h
Volume Flow	$10^{(x-6)}$ m ³ /h	0.001 l/h to 10000 l/h
Volume Flow Ext.	$10^{(x-7)}$ m ³ /min	0.0001 l/min to 1000 l/min
Volume Flow Ext.	$10^{(x-9)}$ m ³ /s	0.001 ml/s to 10000 ml/s
Mass Flow	$10^{(x-3)}$ kg/h	0.001 kg/h to 10000 kg/h
Flow Temperature	$10^{(x-3)}$ °C	0.001 °C to 1 °C
Return Temperature	$10^{(x-3)}$ °C	0.001 °C to 1 °C
Temperature Difference	$10^{(x-3)}$ K	1 mK to 1000 mK
External Temperature	$10^{(x-3)}$ °C	0.001 °C to 1 °C
Pressure	$10^{(x-3)}$ bar	1 mbar to 1000 mbar
Averaging Duration	coded like On Time	
Actuality Duration	coded like On Time	
Time Point	x = 0 Date x = 1 Time&Date	Data type G Data type F
Unit for H.C.A.		dimensionless

Data type F:

2^7	2^6	2^5	2^4	2^3	2^2	2^1	2^0
2^{15}	2^{14}	2^{13}	2^{12}	2^{11}	2^{10}	2^9	2^8
2^{23}	2^{22}	2^{21}	2^{20}	2^{19}	2^{18}	2^{17}	2^{16}
2^{31}	2^{30}	2^{29}	2^{28}	2^{27}	2^{26}	2^{25}	2^{24}

Min (0 ... 59);

Hour (0 ... 23);

Day (1 ... 31);

Month (1 ... 12);

Year (0 ... 99);

Time Invalid (0=Valid, 1=Invalid);

Summer Time (0=Standard Time, 1=Summer Time);

Reserved (0).

Data type G:

2^7	2^6	2^5	2^4	2^3	2^2	2^1	2^0
2^{15}	2^{14}	2^{13}	2^{12}	2^{11}	2^{10}	2^9	2^8

Day (1 ... 31);

Month (1 ... 12);

Year (0 ... 99).

For example, if you have defined:

- Type of Data= Energy (J);
- Function Field=Instantaneous Value;
- Dimension= 32 bit;
- Modbus Register=150 (Register 151 declared implicitly because the dimension is 32 bit);
- Modbus Re Scale=152.

After the request, in Modbus register 150 you read 0x0004, in 151 you read 0x5678 and in register 152 is write 0x0006. The value obtained is: $284280 \times 10^{(6)}$ J.

UPDATE DEVICE:

By pressing the **"Update Device"** button it is possible to load the created Configuration into the device; and also the Firmware, if is necessary.

In order to load the parameters or update the firmware in the device, follow these instructions:

- Turn off the Device;
- Connect the RS232 Null Modem Cable from your PC to the Gateway;
- Insert the Boot Jumper (see "FUNCTION MODES" section);
- Select the **"COM port"** and press the **"Connect"** button;
- Turn on the device;
- Check the BOOT Led. It must blink quickly (see "LEDS" section);
- Press the **"Next"** button;
- Select which operations you want to do.
- Press the **"Execute update firmware"** button to start the upload;
- When all the operations are "OK" turn off the device;
- Disconnect the Boot jumper;
- Disconnect the RS232 Cable;
- Turn on the device.

At this point the configuration/firmware on the device is correctly update.

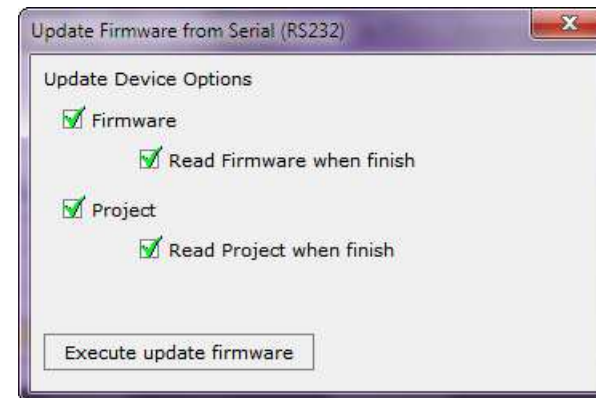
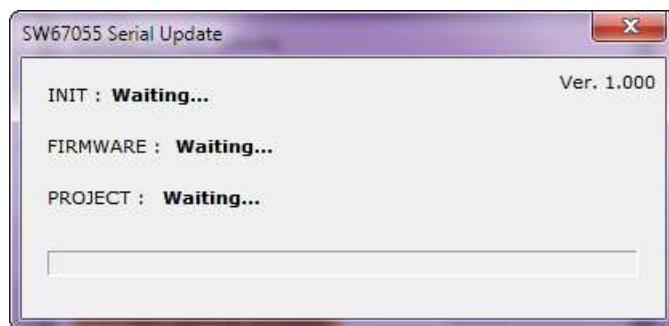



Figure 5: "Update Device" windows

 **Note:**
When you install a new version of the software it is better if the first time you do the update of the Firmware in the HD67055 device.

 **Warning:**
If the Fig. 6 appears when you try to do the Update before require assistance try these points:

- Check if the serial COM port selected is the correct one;
- Check if the serial cable is connected between the PC and the device;
- Try to repeat the operations for the updating;
- If you are using a USB↔RS232 converter try with a native COM port or change the converter;
- Try with another PC;
- Try to restart the PC;
- If you are using the program inside a Virtual Machine, try to use in the main Operating System;
- If you are using Windows Seven or Vista, make sure that you have the administrator privileges.

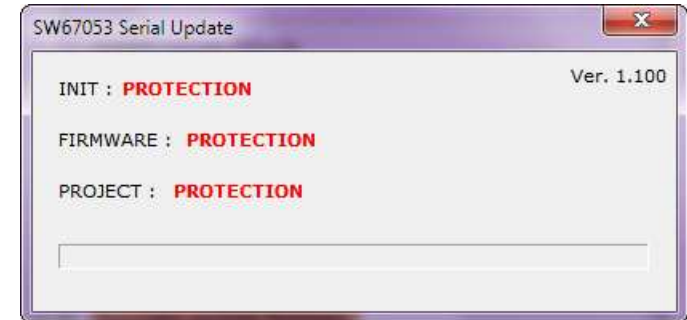

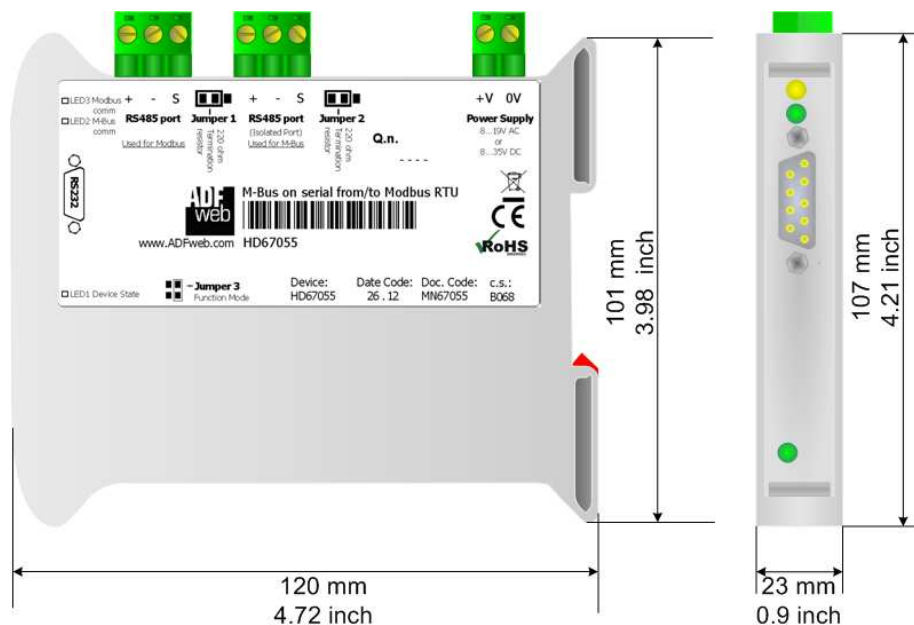

Figure 6: "Protection" window

 In the case of HD67055 you have to use the software "SW67055": www.adfweb.com/download/filefold/SW67055.zip.

MECHANICAL DIMENSIONS:



Housing: PVC

Weight: 200g (Approx)

Figure 7: Mechanical dimensions scheme for HD67055

ORDER CODES:

Order Code: **HD67055** - Modbus Slave / M-Bus Master - Converter

ACCESSORIES:

Order Code: **AC34107** - Null Modem Cable Fem/Fem DSub 9 Pin 1,5 m

Order Code: **AC34114** - Null Modem Cable Fem/Fem DSub 9 Pin 5 m

Order Code: **AC34001** - Rail DIN - Power Supply 220/240V AC 50/60Hz – 12 V AC

Order Code: **AC34002** - Rail DIN - Power Supply 110V AC 50/60Hz – 12 V AC

DISCLAIMER

All technical content within this document can be modified without notice. The content of the document content is a recurring audit. For losses due to fire, earthquake, third party access or other accidents, or intentional or accidental abuse, misuse, or use under abnormal conditions repairs are charged to the user. ADFweb.com S.r.l. will not be liable for accidental loss of use or inability to use this product, such as loss of business income. ADFweb.com S.r.l. shall not be liable for consequences of improper use.

OTHER REGULATIONS AND STANDARDS

WEEE INFORMATION



Disposal of old electrical and electronic equipment (as in the European Union and other European countries with separate collection systems).

— This symbol on the product or on its packaging indicates that this product may not be treated as household rubbish. Instead, it should be taken to an applicable collection point for the recycling of electrical and electronic equipment. If the product is disposed correctly, you will help prevent potential negative environmental factors and human health, which could otherwise be caused by inappropriate disposal. The recycling of materials will help to conserve natural resources. For more information about recycling this product, please contact your local city office, your household waste disposal service or the shop where you purchased the product.

RESTRICTION OF HAZARDOUS SUBSTANCES DIRECTIVE



The device respects the 2002/95/EC Directive on the restriction of the use of certain hazardous substances in electrical and electronic equipment (commonly referred to as Restriction of Hazardous Substances Directive or RoHS).

CE MARKING



The product conforms with the essential requirements of the applicable EC directives.

WARRANTIES AND TECHNICAL SUPPORT:

For fast and easy technical support for your ADFweb.com SRL products, consult our internet support at www.adfweb.com. Otherwise contact us at the address support@adfweb.com

RETURN POLICY:

If while using your product you have any problem and you wish to exchange or repair it, please do the following:

- 1) Obtain a Product Return Number (PRN) from our internet support at www.adfweb.com. Together with the request, you need to provide detailed information about the problem.
- 2) Send the product to the address provided with the PRN, having prepaid the shipping costs (shipment costs billed to us will not be accepted).

If the product is within the warranty of twelve months, it will be repaired or exchanged and returned within three weeks. If the product is no longer under warranty, you will receive a repair estimate.

PRODUCTS AND RELATED DOCUMENTS:

Part	Description	URL
HD67120	Converter Ethernet to RS232/RS485	www.adfweb.com?product=HD67120
HD67119	Converter USB 2.0 to RS485 Isolated	www.adfweb.com?product=HD67119
HD67507	Gateway Modbus TCP Server to RTU Master	www.adfweb.com?product=HD67507
HD67510	Gateway Modbus TCP Client to RTU Slave	www.adfweb.com?product=HD67510