

User Manual

Revision 1.000
English

Modbus Slave / SNMP Manager - Converter

(Order Code: HD67175-232-A1, HD67175-485-A1, HD67175-422-A1, HD67175-232-485-A1, HD67175-232-422-A1, HD67175-232-B2, HD67175-485-B2, HD67175-232-485-B2)

Benefits and Main Features:

- Very easy to configure
- Electrical isolation
- Temperature range: -40°C/85°C (-40°F/185°F)

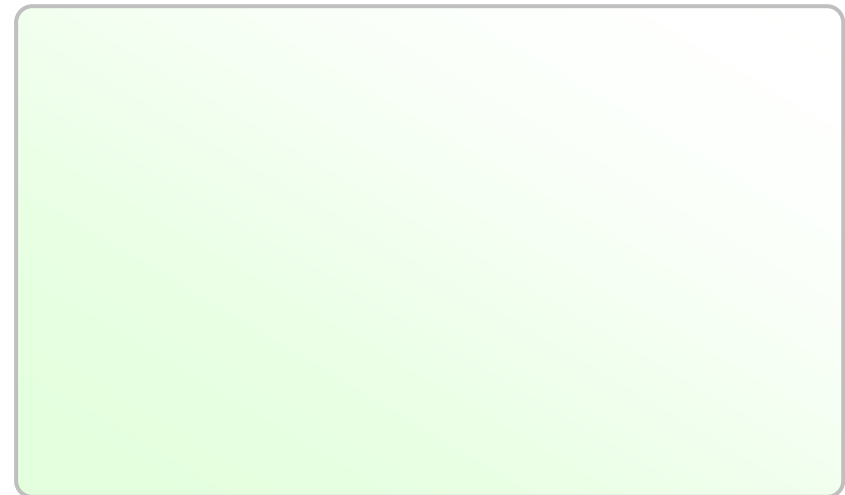
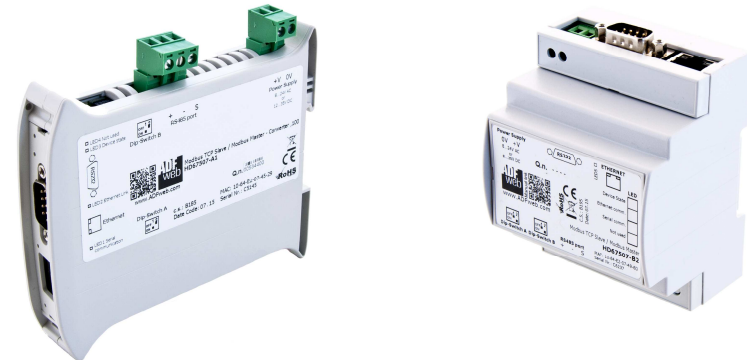

INDEX:

	Page
INDEX	2
UPDATED DOCUMENTATION	2
REVISION LIST	2
WARNING	2
TRADEMARKS	2
SECURITY ALERT	3
EXAMPLE OF CONNECTION	4
CONNECTION SCHEME	5
CHARACTERISTICS	13
CONFIGURATION	13
POWER SUPPLY	14
FUNCTION MODES	15
LEDS	16
SNMP	17
RS232	17
RS485	18
RS422	19
USE OF COMPOSITOR SW67175	20
NEW PROJECT / OPEN PROJECT	21
SOFTWARE OPTIONS	22
SET COMMUNICATION	23
SNMP MANAGER	24
UPDATE DEVICE	26
MECHANICAL DIMENSIONS	28
ORDERING INFORMATIONS	29
ACCESSORIES	30
DISCLAIMER	31
OTHER REGULATIONS AND STANDARDS	31
WARRANTIES AND TECHNICAL SUPPORT	32
RETURN POLICY	32

UPDATED DOCUMENTATION:

Dear customer, we thank you for your attention and we remind you that you need to check that the following document is:

- ✚ Updated
- ✚ Related to the product you own

To obtain the most recently updated document, note the “document code” that appears at the top right-hand corner of each page of this document.

With this “Document Code” go to web page www.adfweb.com/download/ and search for the corresponding code on the page. Click on the proper “Document Code” and download the updates.

REVISION LIST:

Revision	Date	Author	Chapter	Description
1.000	09/10/2015	Ff	All	First Release

WARNING:

ADFweb.com reserves the right to change information in this manual about our product without warning.
ADFweb.com is not responsible for any error this manual may contain.

TRADEMARKS:

All trademarks mentioned in this document belong to their respective owners.

SECURITY ALERT:**GENERAL INFORMATION**

To ensure safe operation, the device must be operated according to the instructions in the manual. When using the device, legal and safety regulation are required for each individual application. The same applies also when using accessories.

INTENDED USE

Machines and systems must be designed so the faulty conditions do not lead to a dangerous situation for the operator (i.e. independent limit switches, mechanical interlocks, etc.).

QUALIFIED PERSONNEL

The device can be used only by qualified personnel, strictly in accordance with the specifications. Qualified personnel are persons who are familiar with the installation, assembly, commissioning and operation of this equipment and who have appropriate qualifications for their job.

RESIDUAL RISKS

The device is state-of-the-art and is safe. The instruments can represent a potential hazard if they are inappropriately installed and operated by untrained personnel. These instructions refer to residual risks with the following symbol:



This symbol indicates that non-observance of the safety instructions is a danger for people that could lead to serious injury or death and / or the possibility of damage.

CE CONFORMITY

The declaration is made by our company. You can send an email to or give us a call if you need it.

EXAMPLE OF CONNECTION:

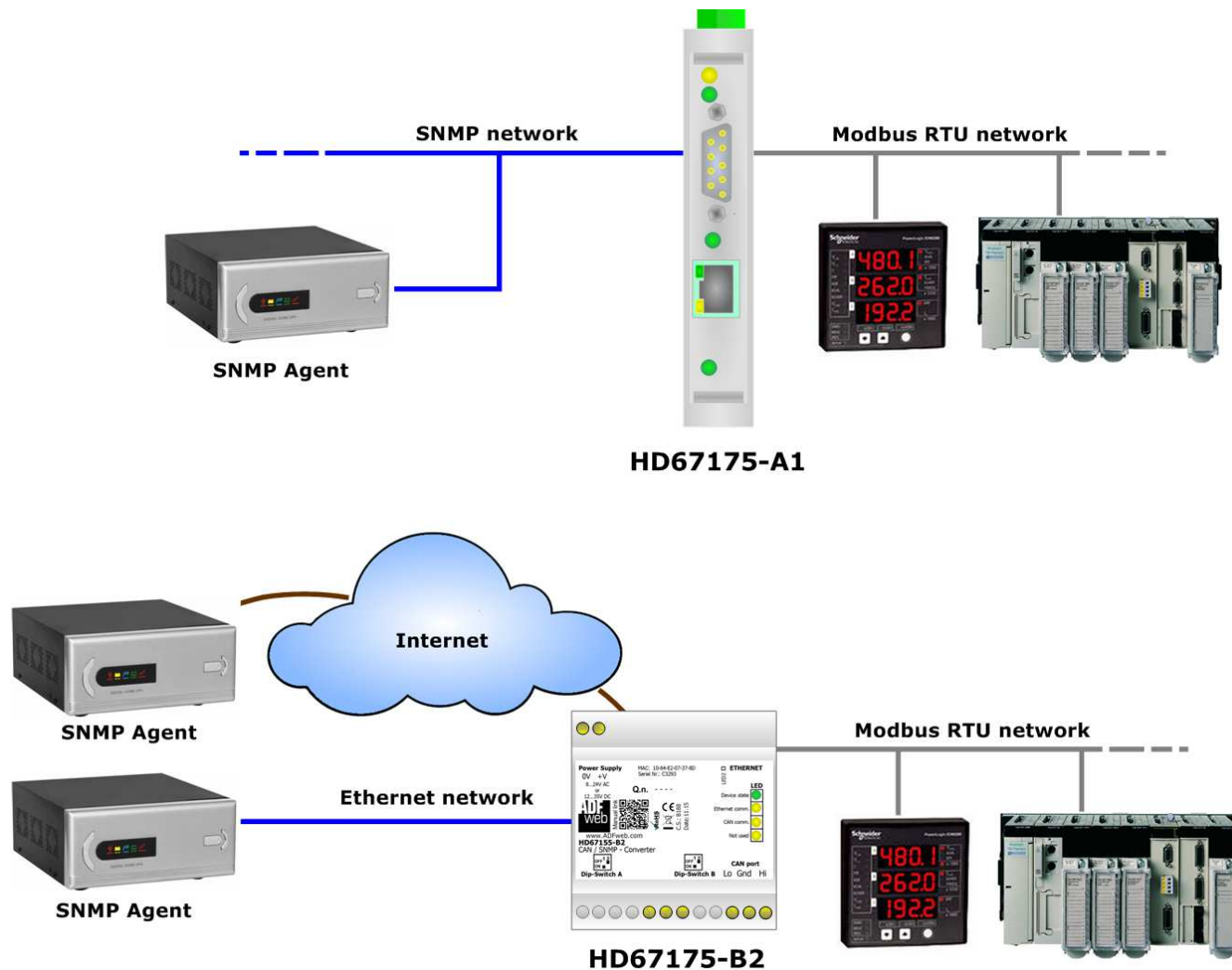

CONNECTION SCHEME:

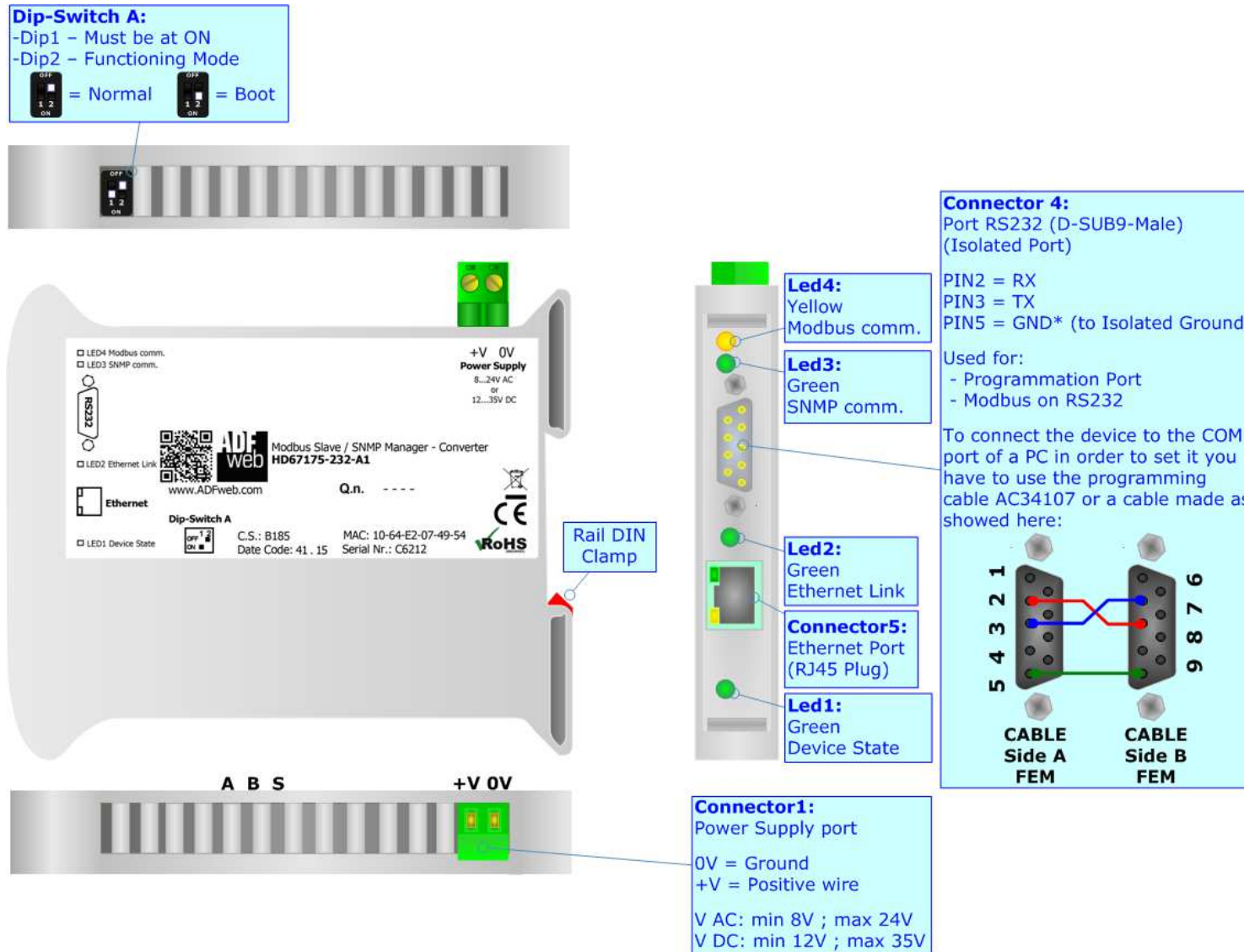

Figure 1a: Connection scheme for HD67175-232-A1

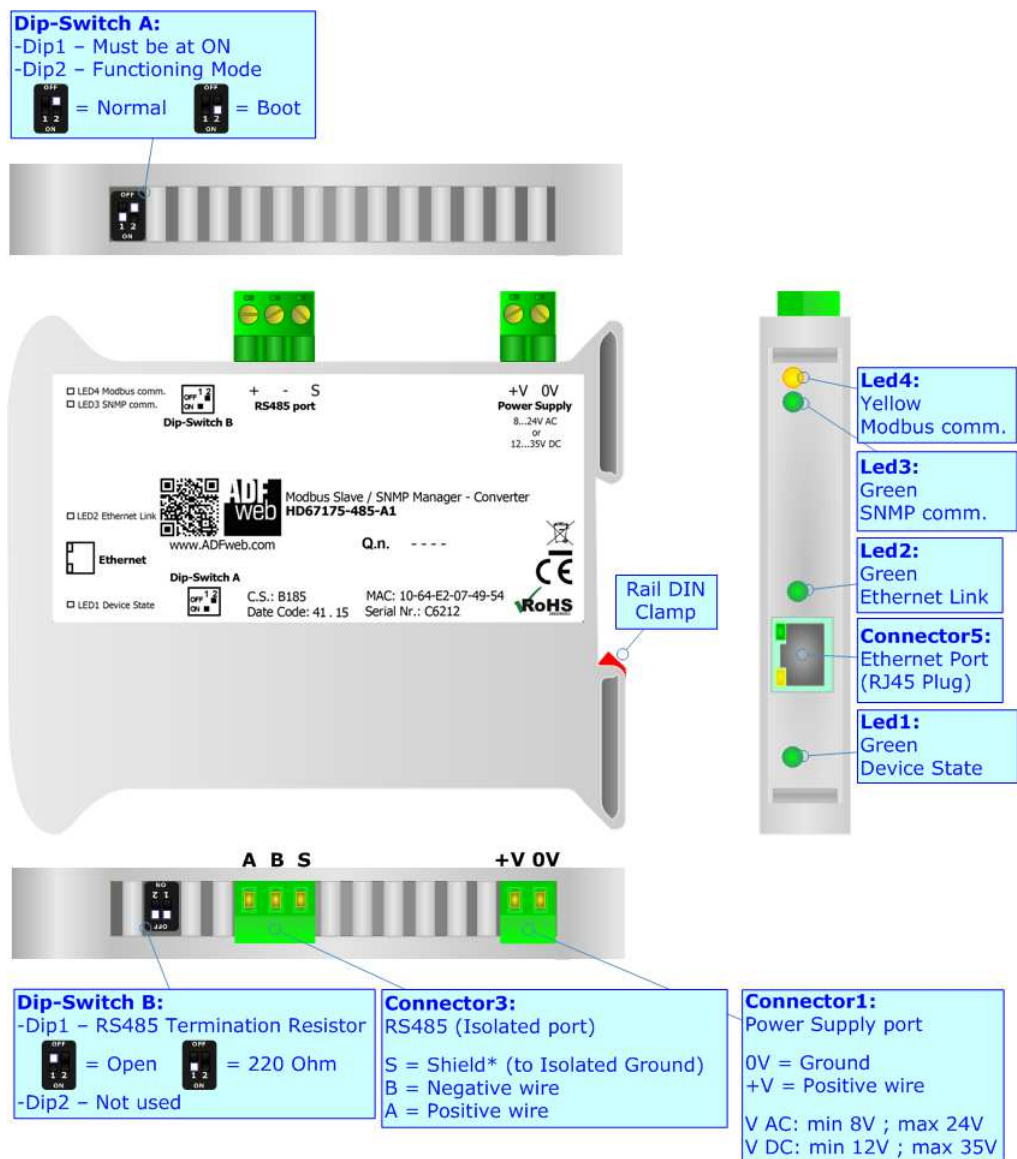

Figure 1b: Connection scheme for HD67175-485-A1

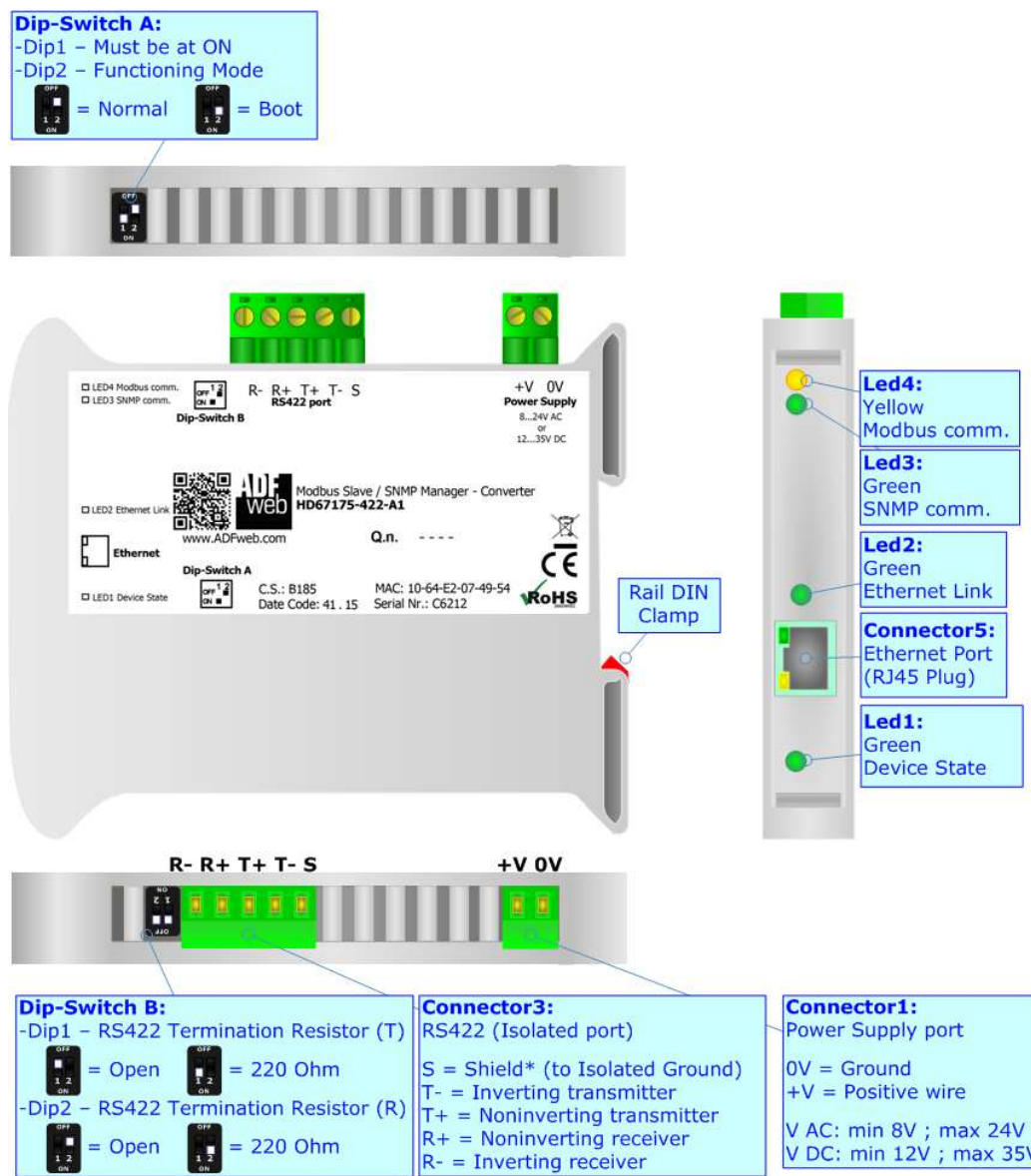

Figure 1c: Connection scheme for HD67175-422-A1

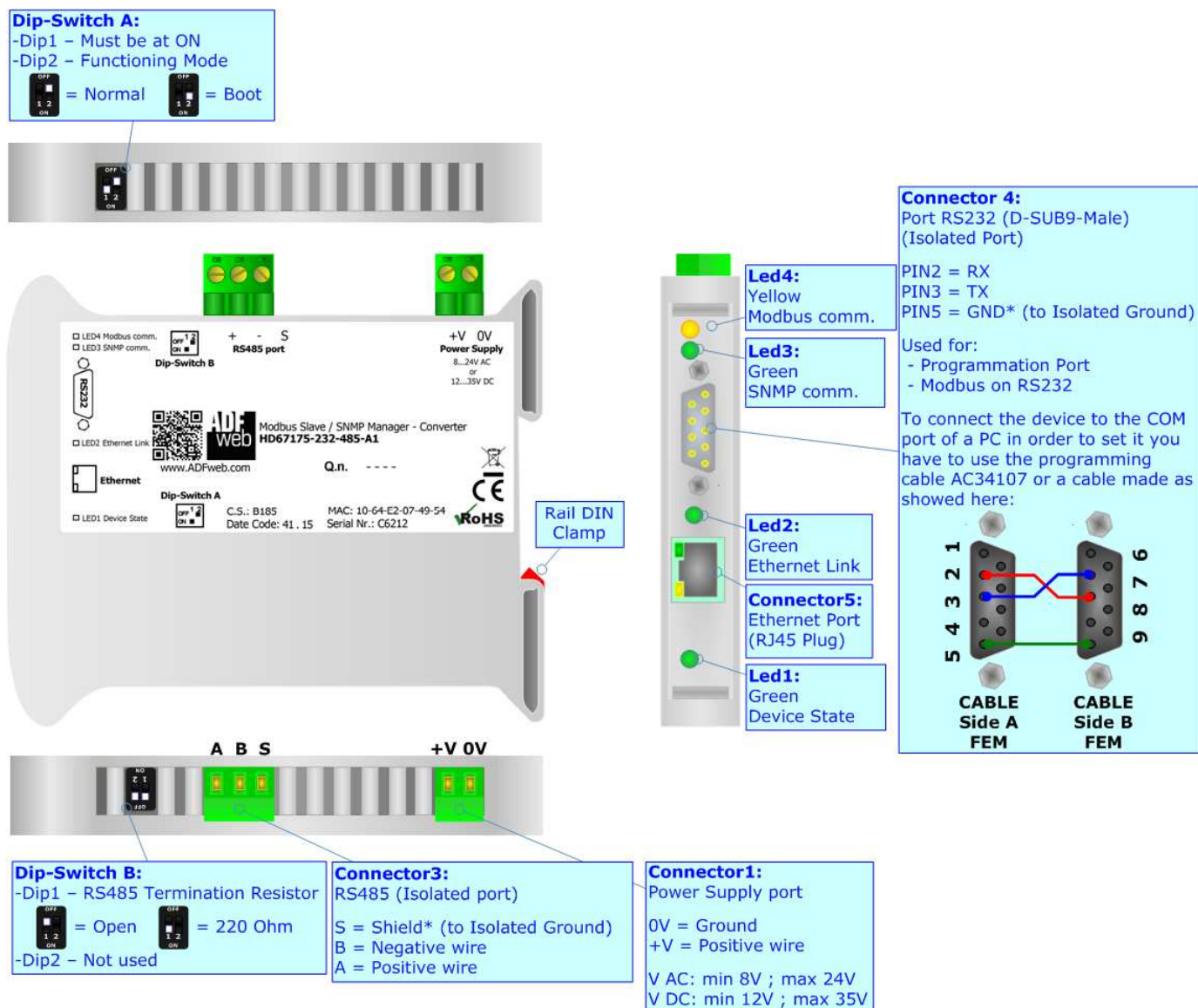

Figure 1d: Connection scheme for HD67175-232-485-A1

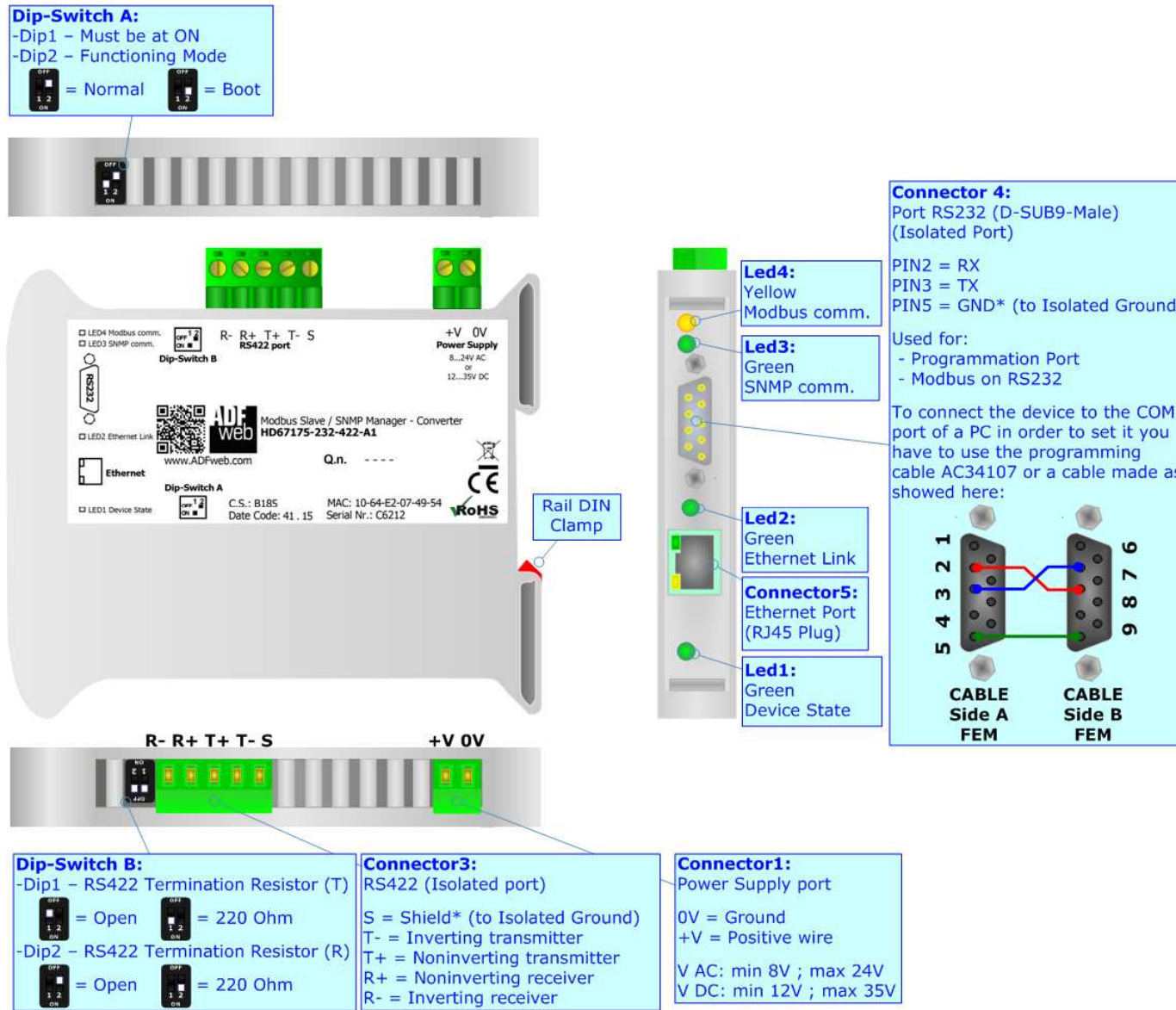

Figure 1e: Connection scheme for HD67175-232-422-A1

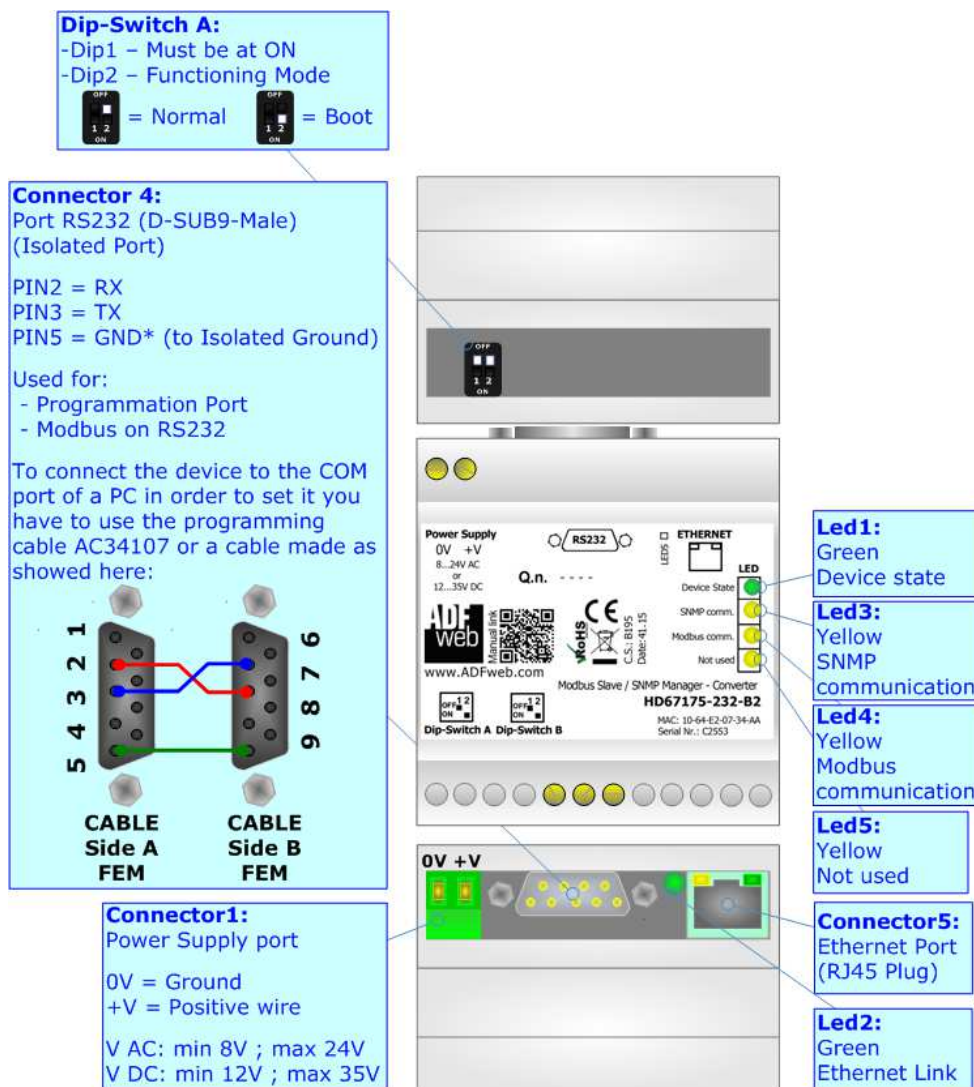

Figure 1f: Connection scheme for HD67175-232-B2

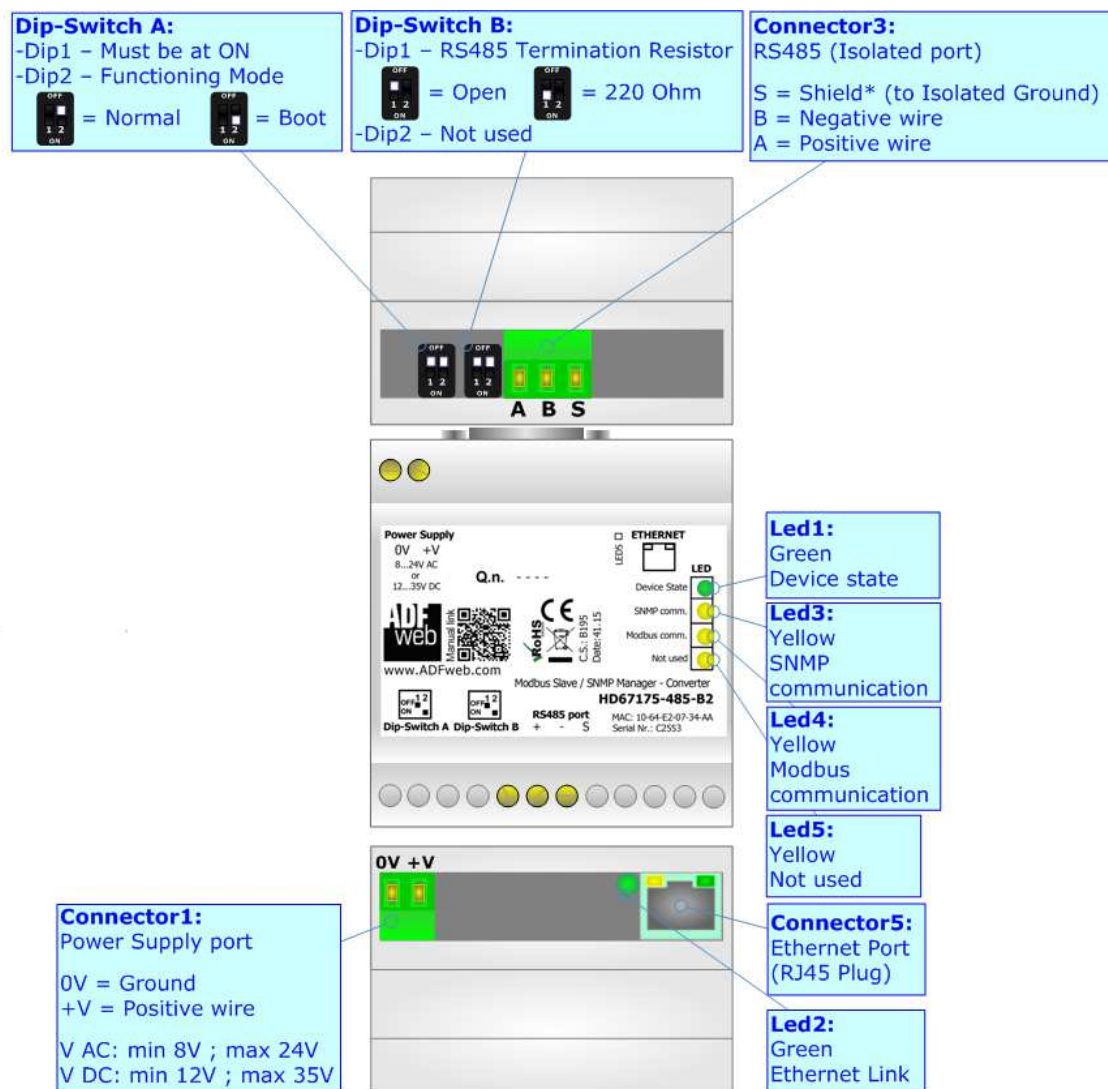

Figure 1g: Connection scheme for HD67175-485-B2

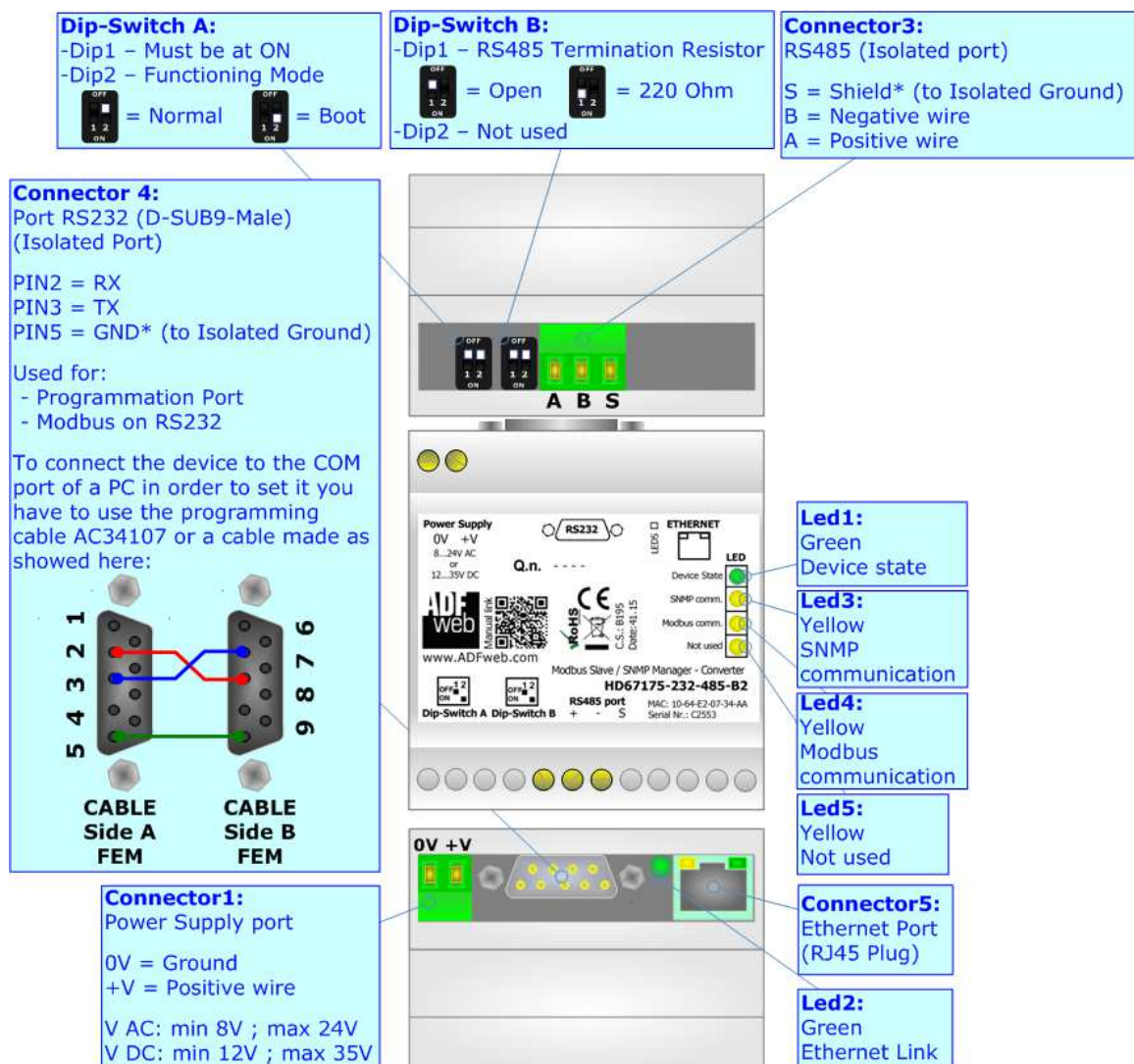

Figure 1g: Connection scheme for HD67175-232-485-B2

CHARACTERISTICS:

The HD67175-A1 and HD67175-B2 is a Modbus Slave / SNMP Manager - Converter.

It has the following characteristics:

- Up to 2000 bytes in reading and 2000 bytes in writing;
- Triple isolation between Serial - Power Supply, Serial - Ethernet, Power Supply - Ethernet.
- Two-directional information between Modbus bus and SNMP bus;
- Mountable on 35mm Rail DIN;
- Wide power supply input range: 8...24V AC or 12...35V DC;
- Wide temperature range: -40°C / 85°C [-40°F / +185°F].

CONFIGURATION:

You need Compositor SW67175 software on your PC in order to perform the following:

- Define the parameter of SNMP line;
- Define the parameter of Modbus line;
- Define the SNMP requests to send to the SNMP Agents;
- Update the device.

POWER SUPPLY:

The devices can be powered at 8...24V AC and 12...35V DC. For more details see the two tables below.

VAC		VDC	
Vmin	Vmax	Vmin	Vmax
8V	24V	12V	35V

Consumption at 24V DC:

Device	Consumption [W/VA]
HD67175-xxx-A1	3.5
HD67175-xxx-B2	3.5

Connector1:
Power Supply port
0V = Ground
+V = Positive wire
V AC: min 8V ; max 24V
V DC: min 12V ; max 35V

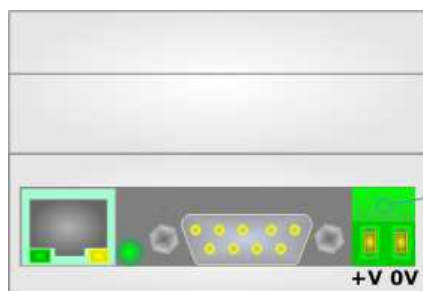
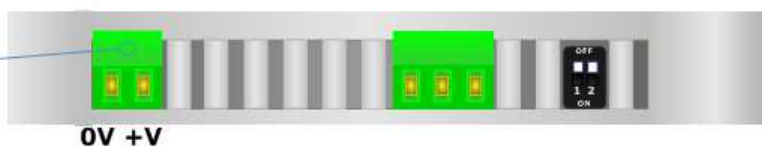

Connector1:
Power Supply port
0V = Ground
+V = Positive wire
V AC: min 8V ; max 24V
V DC: min 12V ; max 35V

Caution: Not reverse the polarity power

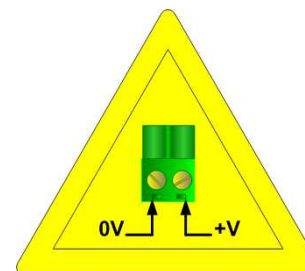

HD67175-xxx-A1

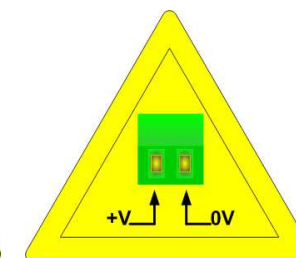

HD67175-xxx-B2

FUNCTION MODES:

The device has got two functions mode depending of the position of the 'Dip2 of Dip-Switch A':

- The first, with 'Dip2 of Dip-Switch A' at "OFF" position, is used for the normal working of the device.
- The second, with 'Dip2 of Dip-Switch A' at "ON" position, is used for upload the Project and/or Firmware.

For the operations to follow for the updating, see 'UPDATE DEVICE' section.

According to the functioning mode, the LEDs will have specifics functions, see 'LEDS' section.

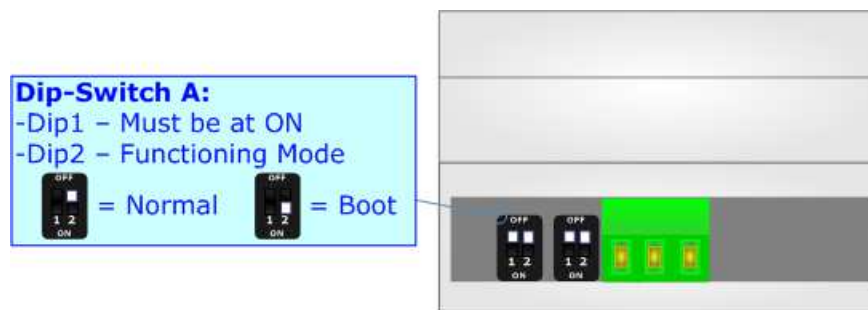

Warning:

Dip1 of 'Dip-Switch A' must be at ON position for working even if the Ethernet cable isn't inserted.

LEDS:

The devices have got four (five for HD67175-B2) LEDs that are used to give information of the functioning status. The various meanings of the LEDs are described in the table below.

LED	Normal Mode	Boot Mode
1: Device State (green)	Blinks slowly (~1Hz)	Blinks quickly: Boot state Blinks very slowly (~0.5Hz): update in progress
2: Ethernet Link (green)	ON: Ethernet cable connected OFF: Ethernet cable disconnected	ON: Ethernet cable connected OFF: Ethernet cable disconnected
3: SNMP comm. (green/yellow)	Blinks when a correct SNMP response is received	Blinks quickly: Boot state Blinks very slowly (~0.5Hz): update in progress
4: Modbus comm. (yellow)	Blinks when a correct Modbus response is received	Blinks quickly: Boot state Blinks very slowly (~0.5Hz): update in progress
5: Not used (yellow) (Present only on HD67175-B2)	OFF	Blinks quickly: Boot state Blinks very slowly (~0.5Hz): update in progress

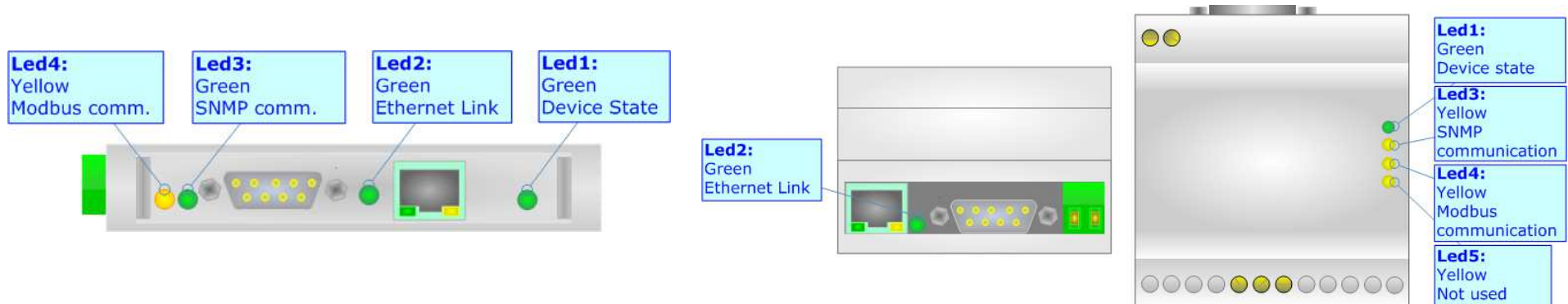

SNMP:

The SNMP connection must be made using Connector5 of HD67175-A1/B2 with at least a Category 5E cable. The maximum length of the cable should not exceed 100m. The cable has to conform to the T568 norms relative to connections in cat.5 up to 100 Mbps. To connect the device to an Hub/Switch is recommended the use of a straight cable, to connect the device to a PC/other is recommended the use of a cross cable.

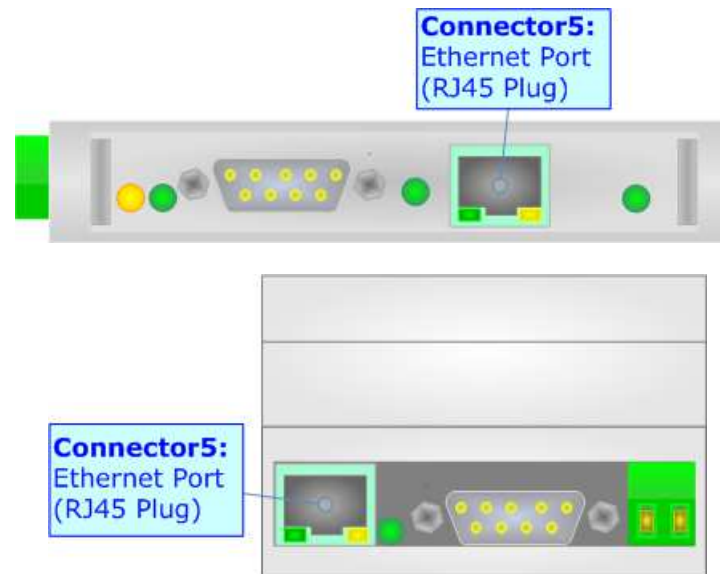
**RS232:**

The connection from RS232 socket to a serial port (example one from a personal computer) must be made with a NULL MODEM cable (a serial cable where the pins 2 and 3 are crossed).

It is recommended that the RS232 cable not exceed 15 meters.

RS485:

To terminate the RS485 line with a 220Ω resistor it is necessary to put ON dip 1, like in figure.

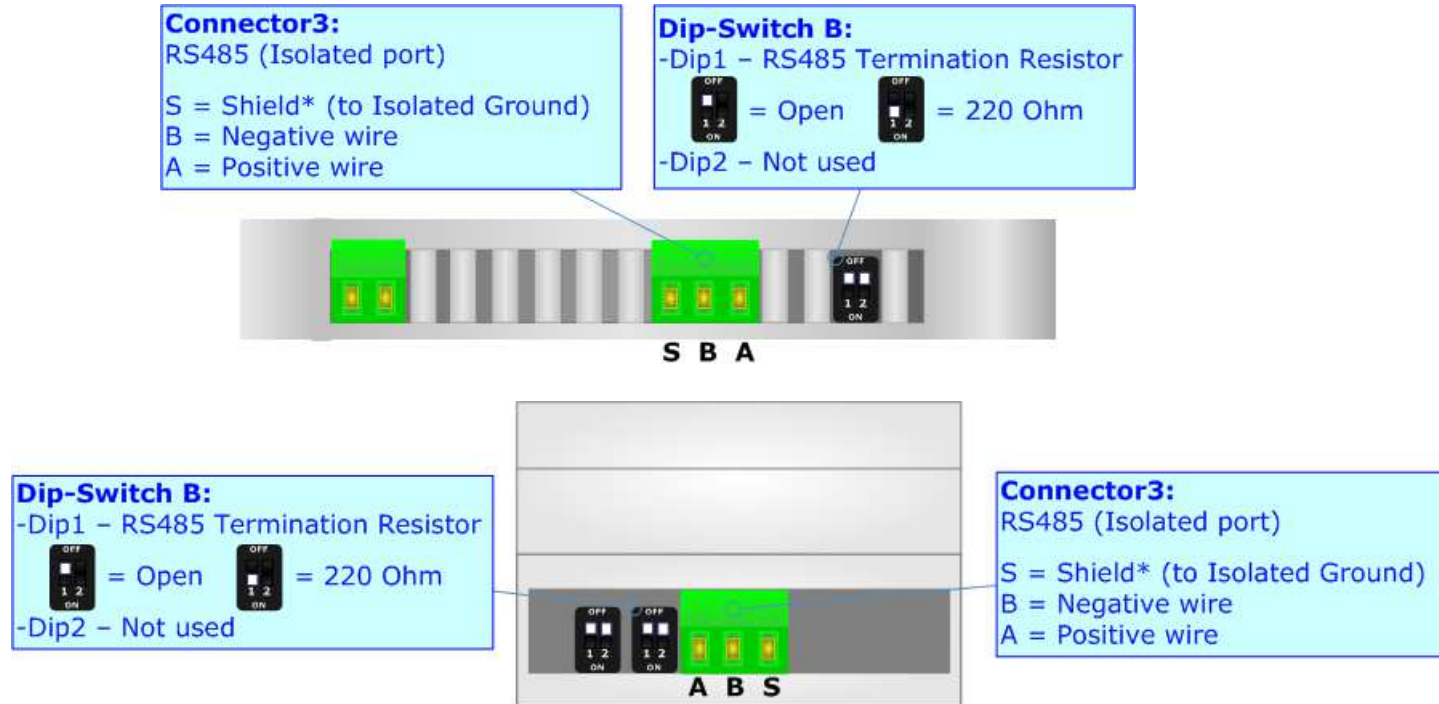

The maximum length of the cable should be 1200m (4000 feet).

Here some codes of cables:

- Belden: p/n 8132 - 2x 28AWG stranded twisted pairs conductor + foil shield + braid shield;
- Belden p/n 82842 - 2x 24AWG stranded twisted pairs conductor + foil shield + braid shield;
- Tasker: p/n C521 - 1x 24AWG twisted pair conductor + foil shield + braid shield;
- Tasker: p/n C522 - 2x 24AWG twisted pairs conductor + foil shield + braid shield.

RS422:

For terminate the RS485 line with a 220Ω resistor it is necessary to put ON dip 1 for T line and/or put ON dip 2 for R line, like in figure.

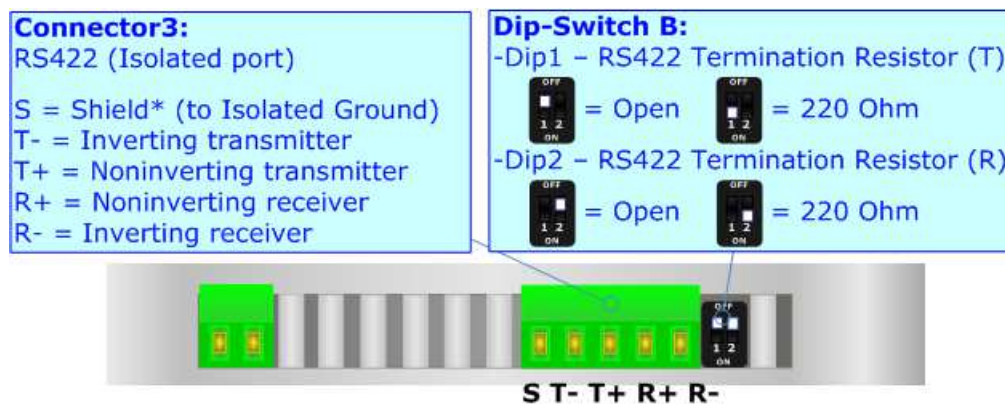

The maximum length of the cable should be 1200m (4000 feet).

USE OF COMPOSITOR SW67175:

To configure the Converter, use the available software that runs with Windows called SW67175. It is downloadable on the site www.adfweb.com and its operation is described in this document. (*This manual is referenced to the last version of the software present on our web site*). The software works with MSWindows (XP, Vista, Seven, 8, 10; 32/64bit).

When launching the SW67175, the window below appears (Fig. 2).



Note:

It is necessary to have installed .Net Framework 4.

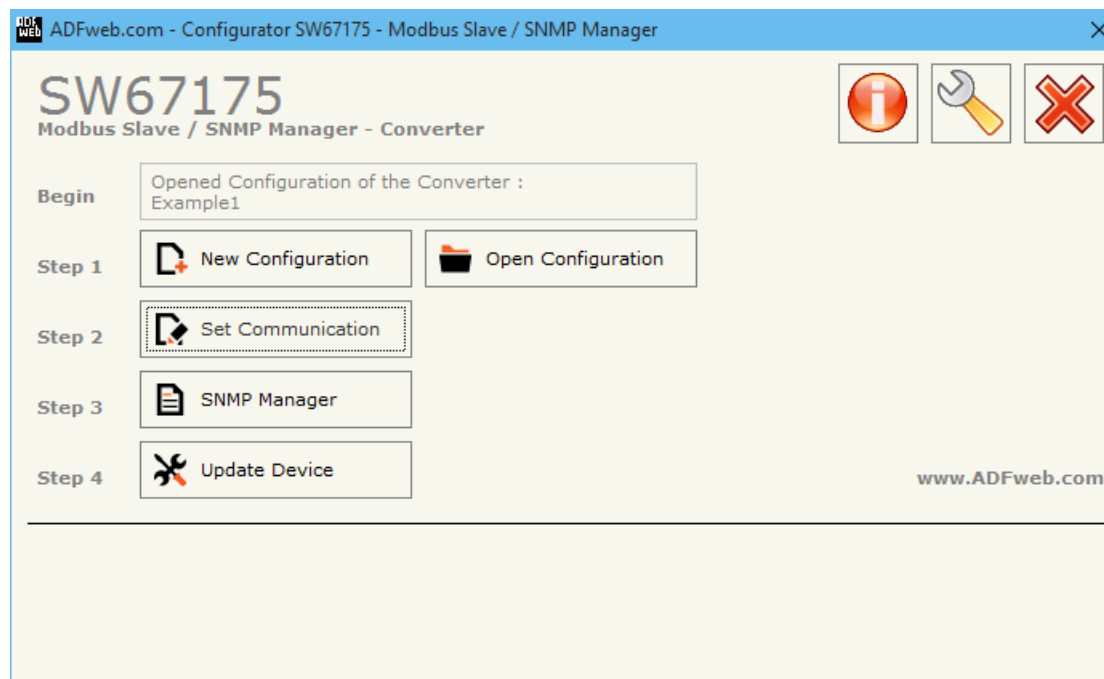
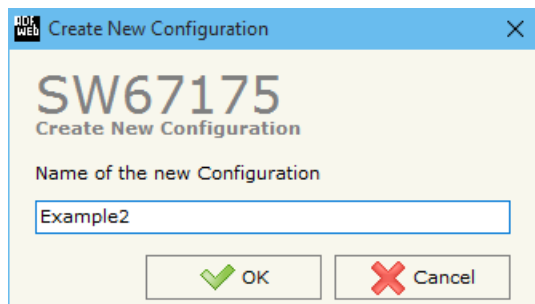

Figure 2: Main window for SW67175

NEW CONFIGURATION / OPEN CONFIGURATION:

The “**New Configuration**” button creates the folder which contains the entire device’s configuration.



A device’s configuration can also be imported or exported:

- To clone the configurations of a Programmable “Modbus Slave / SNMP Manager - Converter” in order to configure another device in the same manner, it is necessary to maintain the folder and all its contents;
- To clone a project in order to obtain a different version of the project, it is sufficient to duplicate the project folder with another name and open the new folder with the button “**Open Configuration**”.

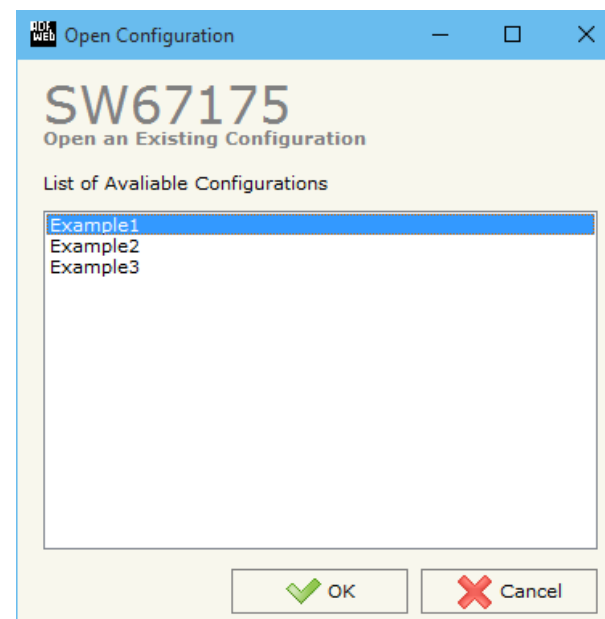

SOFTWARE OPTIONS:

By pressing the “**Settings**” () button there is the possibility to change the language of the software and check the updatings for the compositor.

In the section “Language” it is possible to change the language of the software.

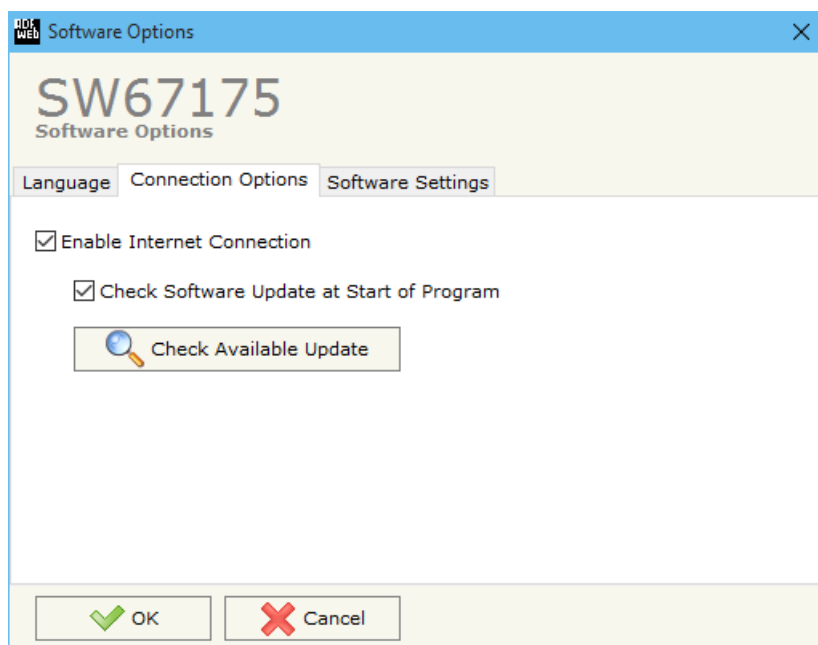

In the section “Connection Options”, it is possible to check if there are some updatings of the software compositor in ADFweb.com website. Checking the option “**Check Software Update at Start of Program**”, the SW67175 check automatically if there are updatings when it is launched.

SET COMMUNICATION:

This section define the fundamental communication parameters of two buses, SNMP and Modbus.

By Pressing the **"Set Communication"** button from the main window for SW67175 (Fig. 2) the window "Set Communication" appears (Fig. 3).

The window is divided in two sections, one for the SNMP Manager and the other for the Modbus Slave.

The means of the fields for "SNMP Manager" are:

- In the fields **"IP ADDRESS"** insert the IP address that you want to give to the Converter;
- In the fields **"SUBNET Mask"** insert the SubNet Mask;
- In the fields **"GATEWAY"** insert the default gateway that you want to use. This feature can be enabled or disabled pressing the Check Box field. This feature is used for going out of the net;
- In the field **"SNMP Name of Station"** is possible to assign a name to the SNMP node.

The means of the fields for the "Modbus Slave" section are:

- In the field **"Serial"** the serial to use is defined (RS232, RS485 or RS422);
- In the field **"Baudrate"** the baudrate for the serial line is defined;
- In the field **"Parity"** the parity of the serial line is defined;
- In the field **"Device ID"** the address of the Modbus side is defined;

The screenshot shows a web-based configuration window titled "Set Communication" for device "SW67175". The window is divided into two main sections: "SNMP Manager" and "Modbus Slave".

SNMP Manager Section:

- IP ADDRESS:** 192.168.0.10
- SUBNET Mask:** 255.255.255.0
- GATEWAY:** (unchecked)
- GATEWAY:** 192.168.0.1
- SNMP Name of Station:** devicename1

Modbus Slave Section:

- Serial:** RS232
- Baudrate:** 115200
- Parity:** NONE
- ID Device:** 10

At the bottom of the window, there are two buttons: "OK" (with a green checkmark) and "Cancel" (with a red X).

Figure 3: "Set Communication" window

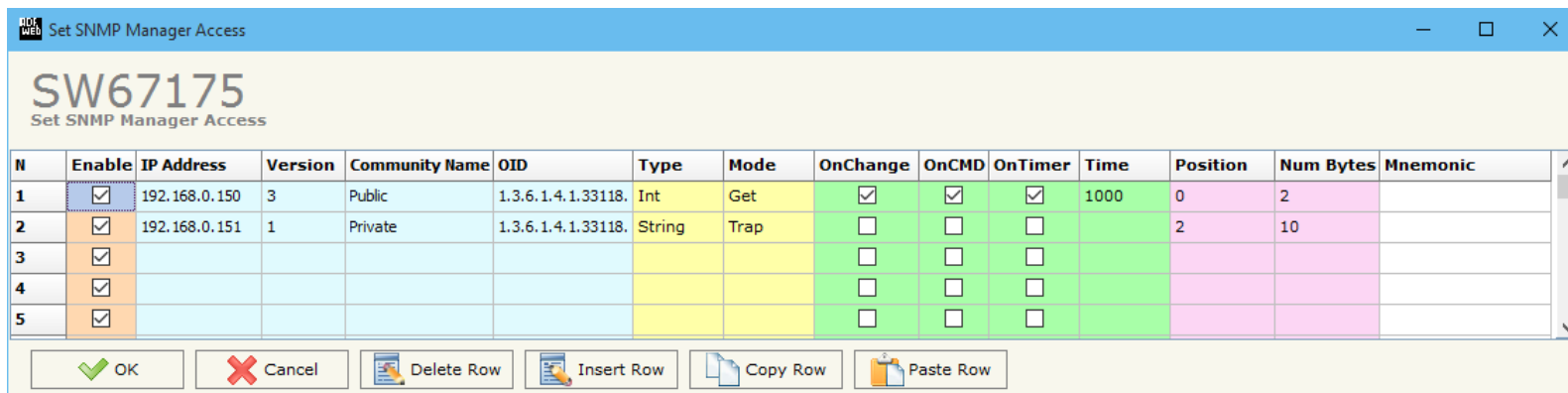
SET ACCESS:

N	Enable	IP Address	Version	Community Name	OID	Type	Mode	OnChange	OnCMD	OnTimer	Time	Position	Num Bytes	Mnemonic
1	<input checked="" type="checkbox"/>	192.168.0.150	3	Public	1.3.6.1.4.1.33118.	Int	Get	<input checked="" type="checkbox"/>	<input checked="" type="checkbox"/>	<input checked="" type="checkbox"/>	1000	0	2	
2	<input checked="" type="checkbox"/>	192.168.0.151	1	Private	1.3.6.1.4.1.33118.	String	Trap	<input type="checkbox"/>	<input type="checkbox"/>	<input type="checkbox"/>		2	10	
3	<input checked="" type="checkbox"/>							<input type="checkbox"/>	<input type="checkbox"/>	<input type="checkbox"/>				
4	<input checked="" type="checkbox"/>							<input type="checkbox"/>	<input type="checkbox"/>	<input type="checkbox"/>				
5	<input checked="" type="checkbox"/>							<input type="checkbox"/>	<input type="checkbox"/>	<input type="checkbox"/>				

Figure 4: "Set SNMP Manager Access" window

By Pressing the "SNMP Manager" button from the main window for SW67175 (Fig. 2) the window "Set SNMP Manager Access" appears (Fig. 4).

The meaning of the fields in the window are the follows:

- If the field "Enable" is checked, the SNMP request is enabled;
- In the field "IP Address" the address of the SNMP Agent device that you have to read/write is defined;
- In the field "Version" the SNMP version used to send the SNMP request (1, 2 or 3) is defined;
- In the field "Community Name" the Community Name used for the SNMP request ('Public' or 'Private') is defined;
- In the field "OID" the OID to read/write from/to the SNMP Agent device is defined;
- In the field "Type" the type of data to read/write ('String' or 'Int') is defined;
- In the field "Mode" the type of SNMP request used ('Get', 'Set' or 'Trap') is defined;
- By checking the field "On Change" the SNMP request (only for the 'Set' Mode) is made only if Modbus data written by the Master are changed;
- By checking the field "On CMD" the SNMP request is sent when the Modbus registers associated to this specific SNMP request are required/written;
- If the field "On Timer" is checked, the SNMP request is sent cyclically;
- In the field "Time" the delay in ms between two SNMP requests is defined (if "On Timer" is checked);

- In the field "**Position**" is possible to select the position where take/save the data from/to the internal SNMP array;
- In the field "**Num Bytes**" is possible to select define the dimension of the SNMP Data;
- In the field "**Mnemonic**" a description of the data inserted in the row is defined.

**Note:**

If the field "On change" and "On Timer" is checked and the "Poll Time" is different from 0, the converter sends the SNMP writing request cyclically and also when the data is changed.

**Note:**

If the "Trap" mode is used, the fields "On CMD", "On Change" and "On Timer" must be disabled.

UPDATE DEVICE:

By pressing the **"Update Device"** button, it is possible to load the created Configuration into the device; and also the Firmware, if necessary.

If you don't know the actual IP address of the device you have to use this procedure:

- Turn off the Device;
- Put Dip1 of 'Dip-Switch A' in ON position;
- Turn on the device
- Connect the Ethernet cable;
- Insert the IP **"192.168.2.205"**;
- Press the **"Ping"** button, "Device Found!" must appear;
- Press the **"Next"** button;
- Select which operations you want to do;
- Press the **"Execute update firmware"** button to start the upload;
- When all the operations are "OK" turn off the Device;
- Put Dip1 of 'Dip-Switch A' at OFF position;
- Turn on the device.

At this point the configuration/firmware on the device is correctly updated.

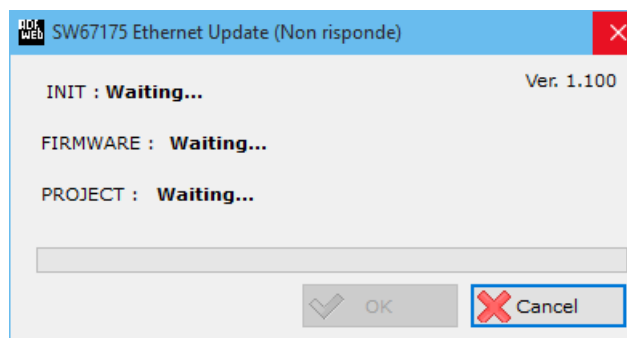
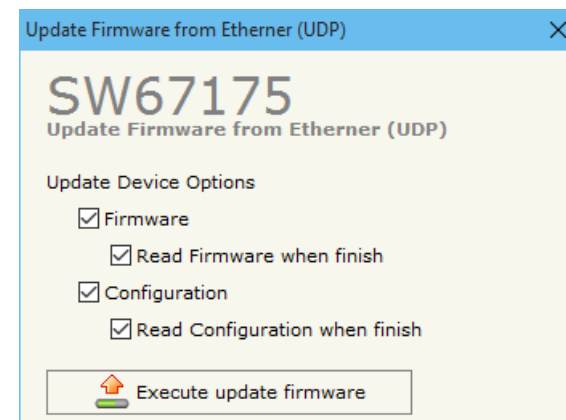
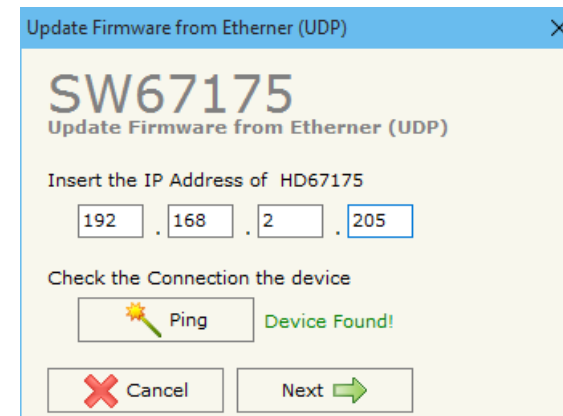



Figure 5: "Update device" windows

If you know the actual IP address of the device, you have to use this procedure:

- Turn on the Device with the Ethernet cable inserted;
- Insert the actual IP of the Converter;
- Press the "**Ping**" button, must appear "Device Found!";
- Press the "**Next**" button;
- Select which operations you want to do;
- Press the "**Execute update firmware**" button to start the upload;
- When all the operations are "OK" the device automatically goes at Normal Mode.

At this point the configuration/firmware on the device is correctly update.

 **Note:**
When you install a new version of the software, if it is the first time it is better you do the update of the Firmware in the HD67175-A1/B2 device.

 **Note:**
When you receive the device, for the first time, you also have to update the Firmware in the HD67175-A1/B2 device.

 **Warning:**
If Fig. 6 appears when you try to do the Update try these points before seeking assistance:

- Try to repeat the operations for the updating;
- Try with another PC;
- Try to restart the PC;
- If you are using the program inside a Virtual Machine, try to use in the main Operating System;
- If you are using Windows Seven or Vista or 8 or 10, make sure that you have the administrator privileges;
- Take attention at Firewall lock;
- Check the LAN settings.

 In the case of HD67175-A1/B2 you have to use the software "SW67175": www.adfweb.com/download/filefold/SW67175.zip.

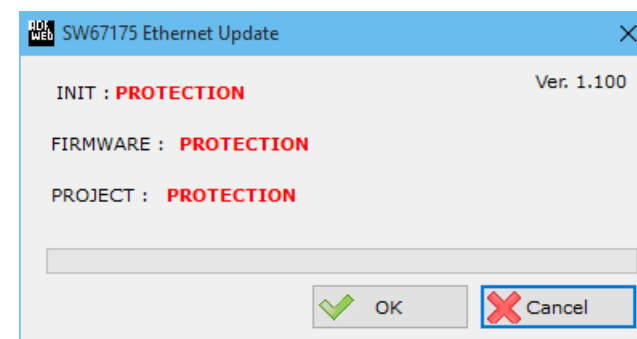
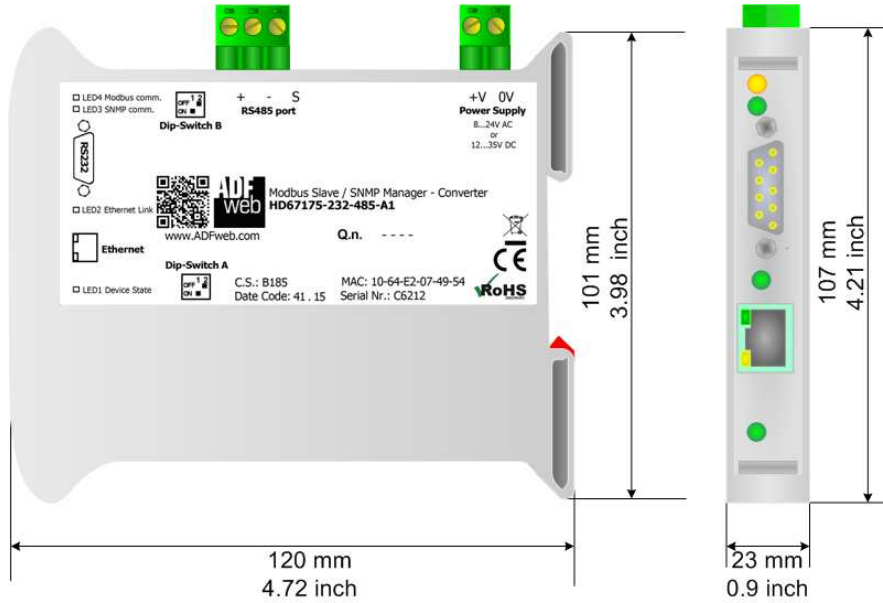

Figure 6: "Protection" window

MECHANICAL DIMENSIONS:



Housing: PVC
Weight: 200g (Approx)

Figure 7a: Mechanical dimensions scheme for HD67175-xxx-A1

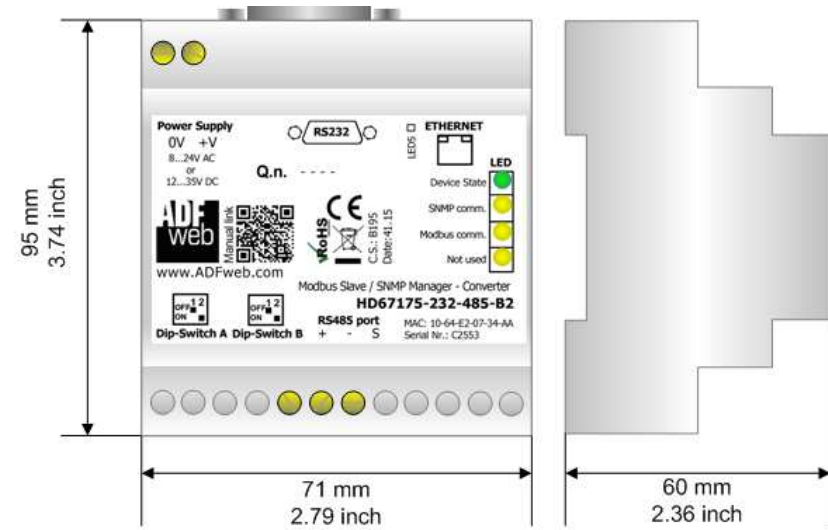

Housing: PVC
Weight: 200g (Approx)

Figure 7b: Mechanical dimensions scheme for HD67175-xxx-B2

ORDERING INFORMATION:

The ordering part number is formed by a valid combination of the following:

HD67175 - xxx - x x

Connectors Type

- 1: Removable 5mm Screw Terminal
- 2: Fixed 5mm Screw Terminal

Enclosure Type

- A: 1M, 35mm DIN Rail mounting
- B: 4M, 35mm DIN Rail mounting

Serial Line

- 232: RS232
- 485: RS485
- 422: RS422 (only for A1 version)
- 232-485: RS232+RS485
- 232-422: RS232+RS422 (only for A1 version)

Device Family

HD67175: Modbus Slave / SNMP Manager - Converter

Order Code: HD67175-232-A1	-	Modbus Slave / SNMP Manager - Converter (RS232 serial)
Order Code: HD67175-485-A1	-	Modbus Slave / SNMP Manager - Converter (RS485 serial)
Order Code: HD67175-422-A1	-	Modbus Slave / SNMP Manager - Converter (RS422 serial)
Order Code: HD67175-232-485-A1	-	Modbus Slave / SNMP Manager - Converter (RS232 + RS485 serial)
Order Code: HD67175-232-422-A1	-	Modbus Slave / SNMP Manager - Converter (RS232 + RS422 serial)
Order Code: HD67175-232-B2	-	Modbus Slave / SNMP Manager - Converter (RS232 serial)
Order Code: HD67175-485-B2	-	Modbus Slave / SNMP Manager - Converter (RS485 serial)
Order Code: HD67175-232-485-B2	-	Modbus Slave / SNMP Manager - Converter (RS232 + RS485 serial)

ACCESSORIES:

- Order Code: **AC34001** - 35mm Rail DIN - Power Supply 220/240V AC 50/60Hz – 12 V AC
- Order Code: **AC34002** - 35mm Rail DIN - Power Supply 110V AC 50/60Hz – 12 V AC

DISCLAIMER:

All technical content within this document can be modified without notice. The content of the document is a under continual renewal. For losses due to fire, earthquake, third party access or other accidents, or intentional or accidental abuse, misuse, or use under abnormal conditions repairs are charged to the user. ADFweb.com S.r.l. will not be liable for accidental loss of use or inability to use this product, such as loss of business income. ADFweb.com S.r.l. shall not be liable for consequences of improper use.

OTHER REGULATIONS AND STANDARDS:**WEEE INFORMATION**

Disposal of old electrical and electronic equipment (as in the European Union and other European countries with separate collection systems).

— This symbol on the product or on its packaging indicates that this product may not be treated as household rubbish. Instead, it should be taken to an applicable collection point for the recycling of electrical and electronic equipment. If the product is disposed correctly, you will help prevent potential negative environmental factors and impact of human health, which could otherwise be caused by inappropriate disposal. The recycling of materials will help to conserve natural resources. For more information about recycling this product, please contact your local city office, your household waste disposal service or the shop where you purchased the product.

RESTRICTION OF HAZARDOUS SUBSTANCES DIRECTIVE

The device respects the 2002/95/EC Directive on the restriction of the use of certain hazardous substances in electrical and electronic equipment (commonly referred to as Restriction of Hazardous Substances Directive or RoHS).

CE MARKING

The product conforms with the essential requirements of the applicable EC directives.

WARRANTIES AND TECHNICAL SUPPORT:

For fast and easy technical support for your ADFweb.com SRL products, consult our internet support at www.adfweb.com.
Otherwise contact us at the address support@adfweb.com

RETURN POLICY:

If while using your product you have any problem and you wish to exchange or repair it, please do the following:

- Obtain a Product Return Number (PRN) from our internet support at www.adfweb.com. Together with the request, you need to provide detailed information about the problem.
- Send the product to the address provided with the PRN, having prepaid the shipping costs (shipment costs billed to us will not be accepted).

If the product is within the warranty of twelve months, it will be repaired or exchanged and returned within three weeks. If the product is no longer under warranty, you will receive a repair estimate.



ADFweb.com S.r.l.
Via Strada Nuova, 17
IT-31010 Mareno di Piave
TREVISO (Italy)
Phone +39.0438.30.91.31
Fax +39.0438.49.20.99
www.adfweb.com

