

# User Manual

## Benefits and Main Features:

- ⊕ Very easy to configure
- ⊕ Triple Electrical isolation
- ⊕ Temperature range: -40°C/+85°C (-40°F/+185°F)



User Manual

**INDEX:**

	Page
INDEX	2
UPDATED DOCUMENTATION	2
REVISION LIST	2
WARNING	2
TRADEMARKS	2
SECURITY ALERT	3
EXAMPLE OF CONNECTION	4
CONNECTION SCHEME	7
CHARACTERISTICS	12
CONFIGURATION	12
POWER SUPPLY	13
FUNCTION MODES	14
LEDS (for HD67714-IP-A1)	15
LEDS (for HD67714-MSTP-A1/B2 and HD67714-PTP-A1/B2)	16
RS485 (for HD67714-MSTP-A1/B2)	17
RS232 (for HD67714-PTP-A1/B2)	18
ETHERNET	18
USE OF COMPOSITOR SW67714	19
NEW CONFIGURATION / OPEN CONFIGURATION	20
SOFTWARE OPTIONS	21
SET COMMUNICATION	22
SET BACNET ACCESS	25
UPDATE DEVICE	29
MECHANICAL DIMENSIONS	31
ORDERING INFORMATIONS	34
ACCESSORIES	34
DISCLAIMER	35
OTHER REGULATIONS AND STANDARDS	35
WARRANTIES AND TECHNICAL SUPPORT	36
RETURN POLICY	36
PRODUCTS AND RELATED DOCUMENTS	36

**UPDATED DOCUMENTATION:**

Dear customer, we thank you for your attention and we remind you that you need to check that the following document is:

- Updated
- Related to the product you own

To obtain the most recently updated document, note the “document code” that appears at the top right-hand corner of each page of this document.

With this “Document Code” go to web page [www.adfweb.com/download/](http://www.adfweb.com/download/) and search for the corresponding code on the page. Click on the proper “Document Code” and download the updates.

**REVISION LIST:**

Revision	Date	Author	Chapter	Description
1.000	18/03/2014	Ff	All	First Release
1.001	24/07/2014	Fl	All	Revision
1.010	10/03/2016	Fl	All	Software changed (v1.100)

**WARNING:**

ADFweb.com reserves the right to change information in this manual about our product without warning.

ADFweb.com is not responsible for any error this manual may contain.

**TRADEMARKS:**

All trademarks mentioned in this document belong to their respective owners.

**SECURITY ALERT:****GENERAL INFORMATION**

To ensure safe operation, the device must be operated according to the instructions in the manual. When using the device, legal and safety regulation are required for each individual application. The same applies also when using accessories.

**INTENDED USE**

Machines and systems must be designed so the faulty conditions do not lead to a dangerous situation for the operator (i.e. independent limit switches, mechanical interlocks, etc.).

**QUALIFIED PERSONNEL**

The device can be used only by qualified personnel, strictly in accordance with the specifications. Qualified personnel are persons who are familiar with the installation, assembly, commissioning and operation of this equipment and who have appropriate qualifications for their job.

**RESIDUAL RISKS**

The device is state-of-the-art and is safe. The instruments can represent a potential hazard if they are inappropriately installed and operated by untrained personnel. These instructions refer to residual risks with the following symbol:



This symbol indicates that non-observance of the safety instructions is a danger for people that could lead to serious injury or death and / or the possibility of damage.

**CE CONFORMITY**

The declaration is made by our company. You can send an email to [or](#) give us a call if you need it.

**EXAMPLES OF CONNECTION:**

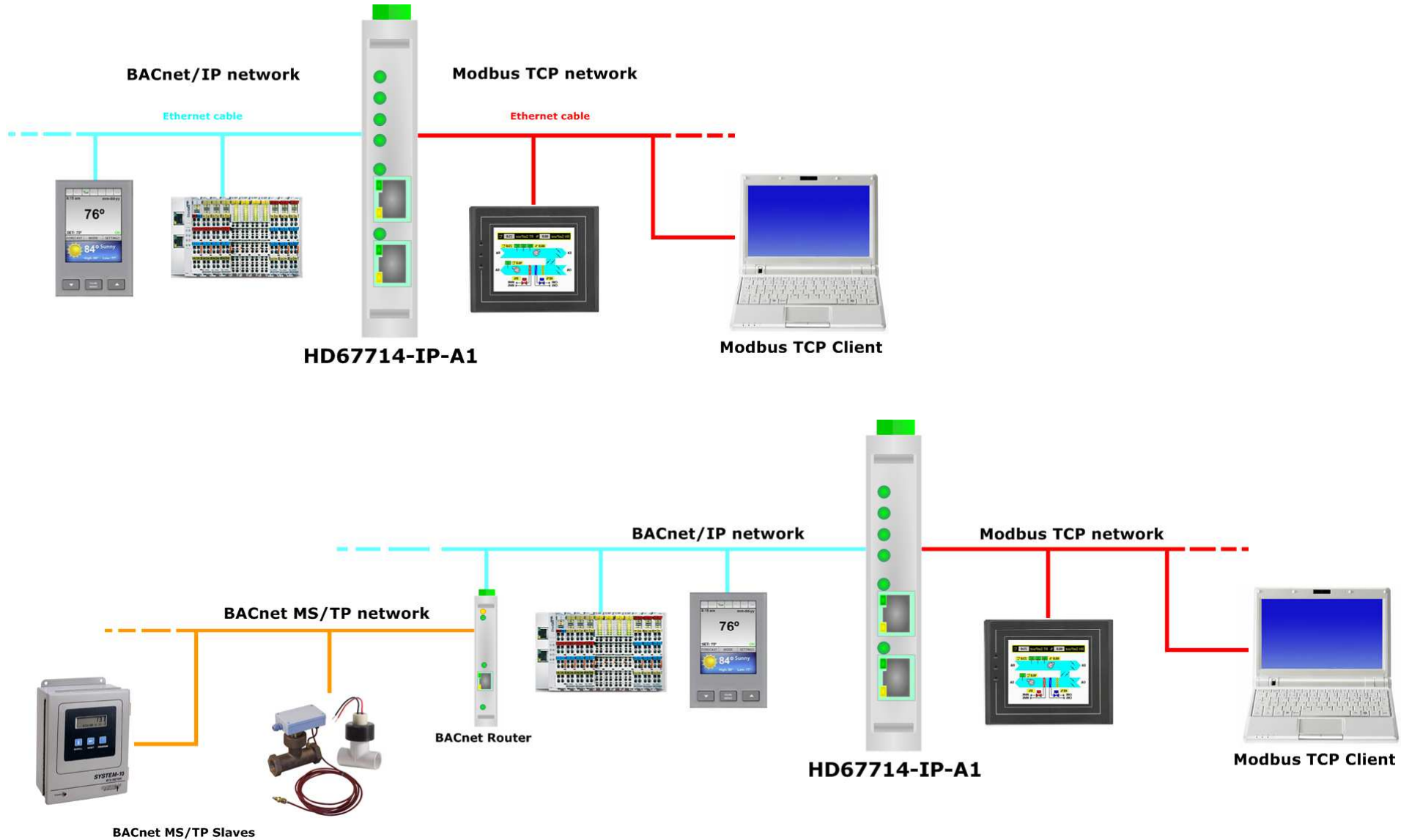

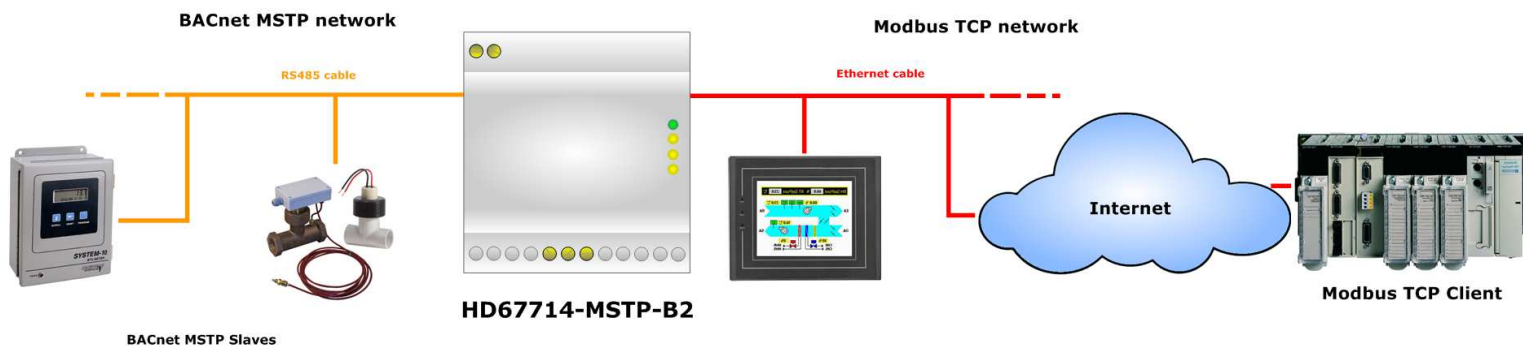
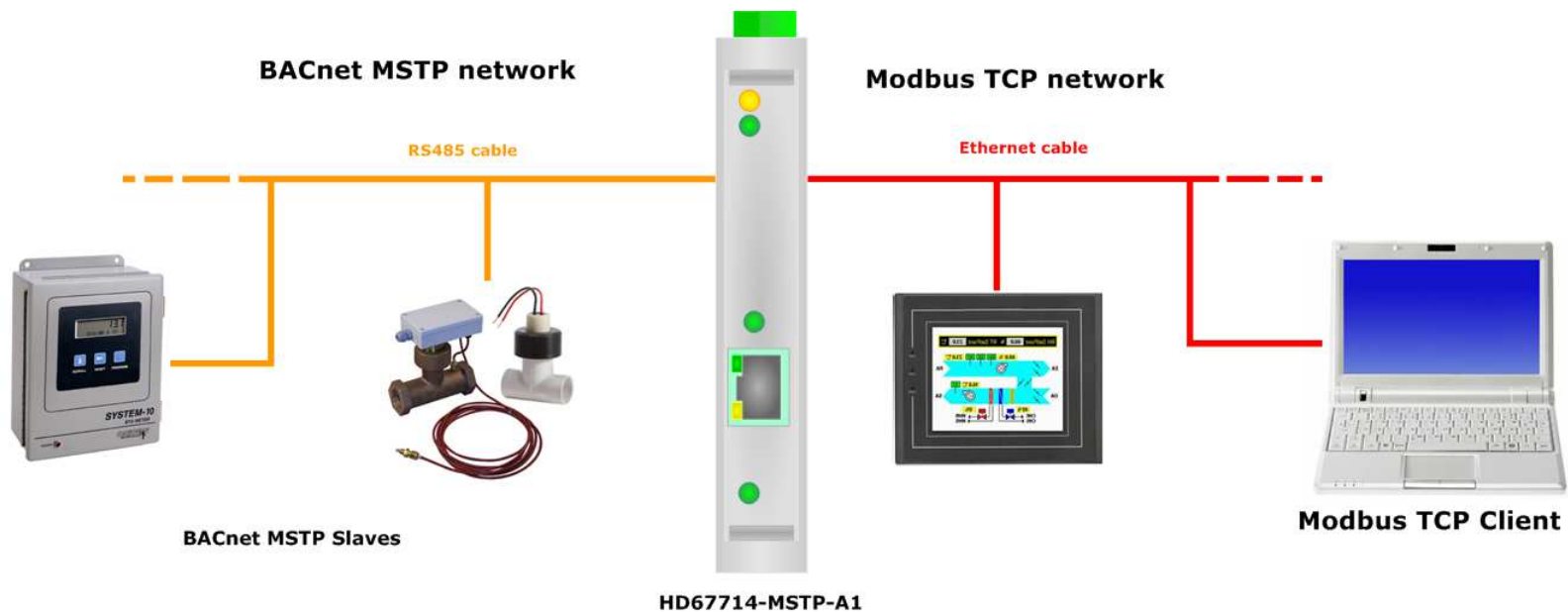

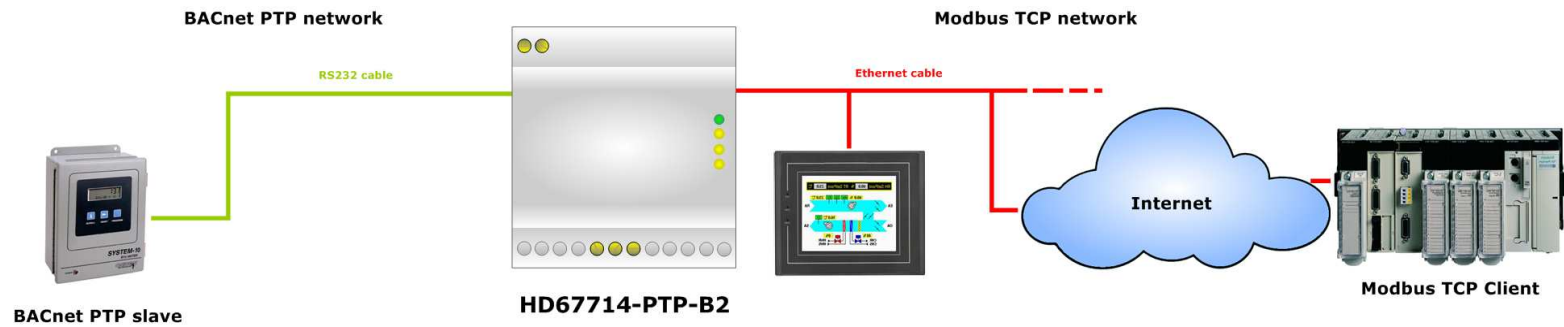
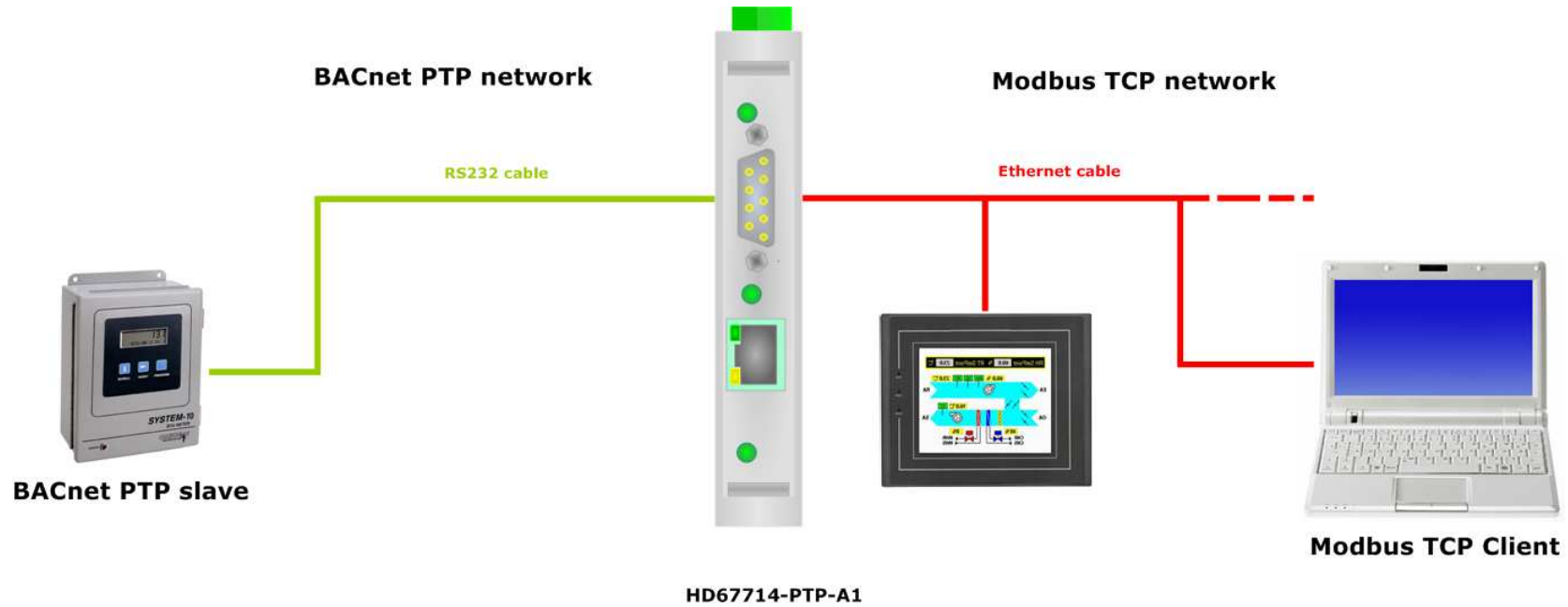

**CONNECTION SCHEME:**

**Dip-Switch A:**  
 -Dip1 – Must be at ON  
 -Dip2 – Functioning Mode  
 = Normal = Boot

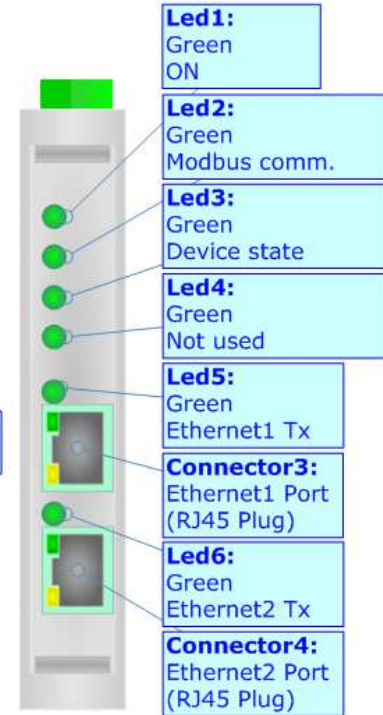
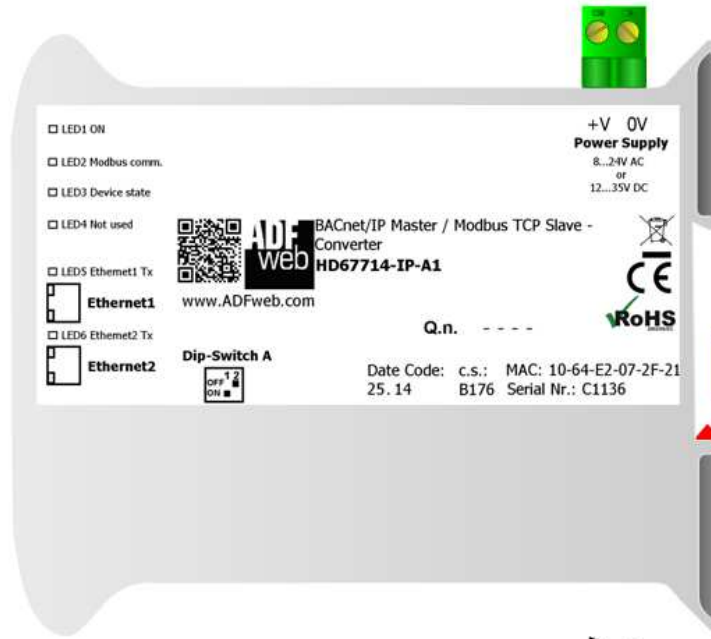

Rail DIN Clamp

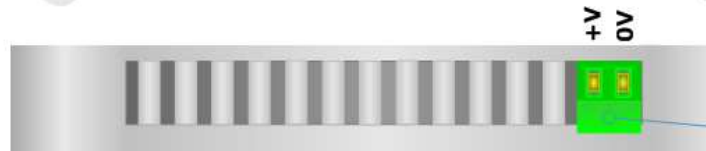

**Connector1:**  
 Power Supply port  
 0V = Ground  
 +V = Positive wire  
 V AC: min 8V ; max 24V  
 V DC: min 12V ; max 35V

Figure 1a: Connection scheme for HD67714-IP-A1

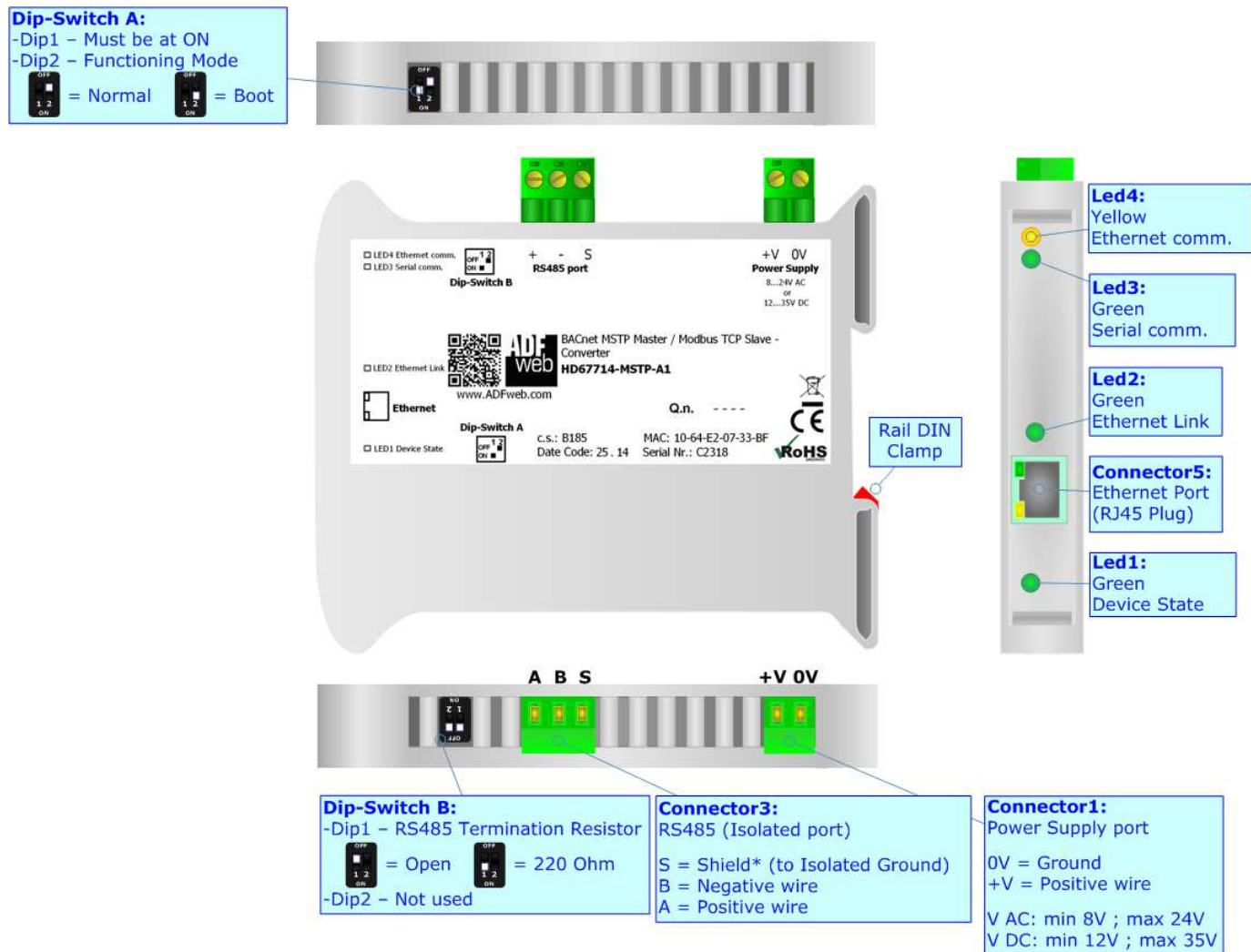

Figure 1b: Connection scheme for HD67714-MSTP-A1



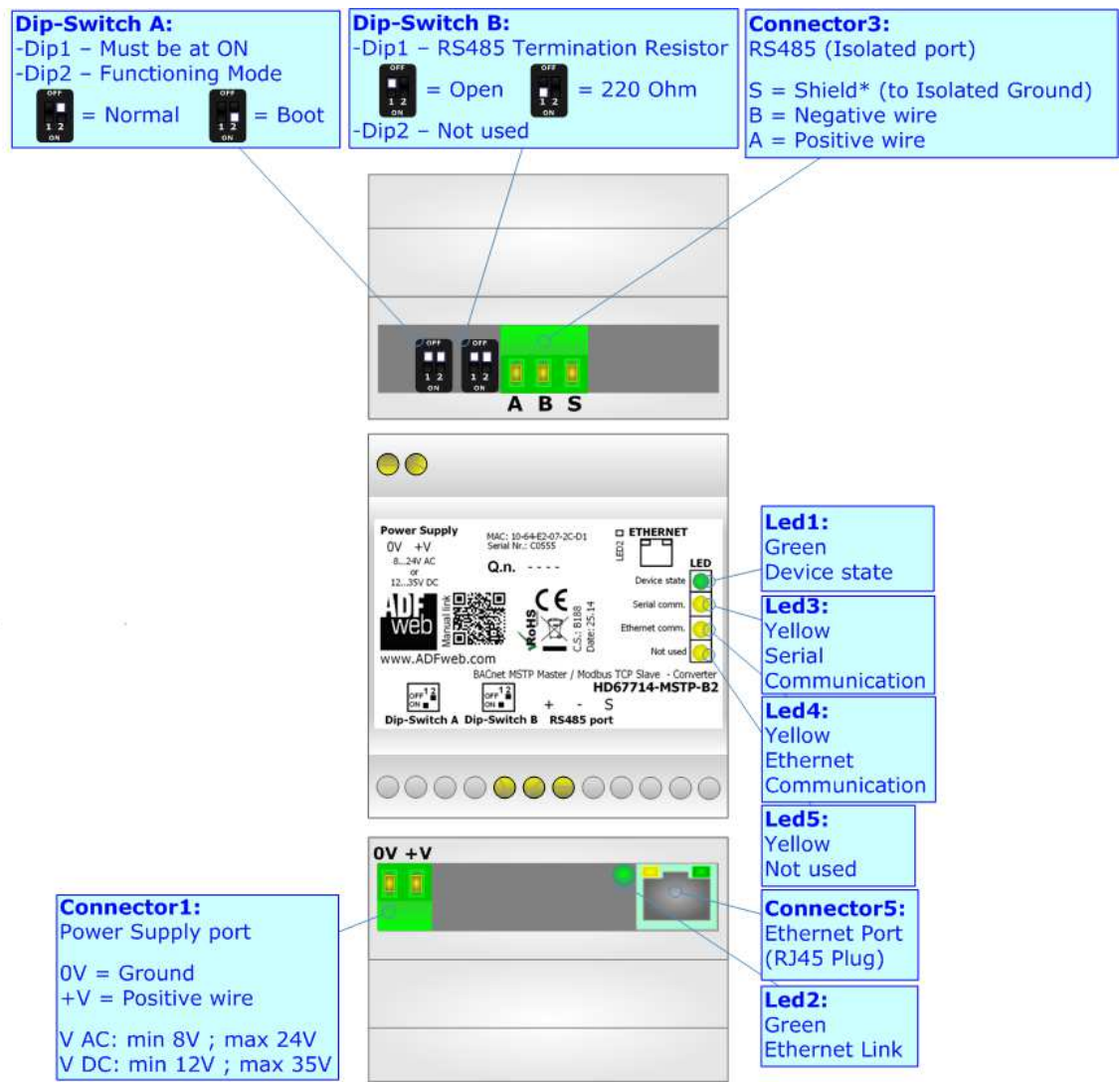
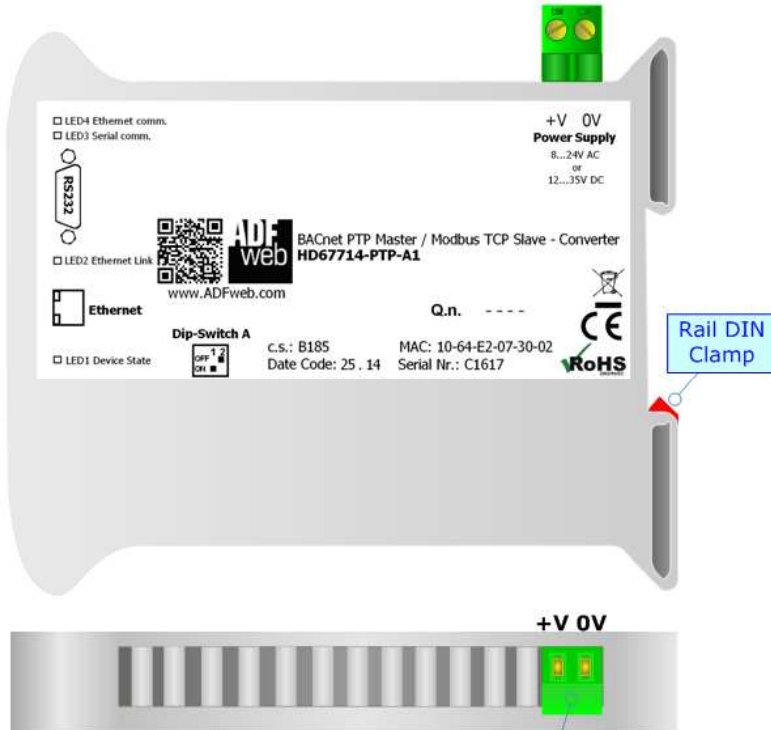
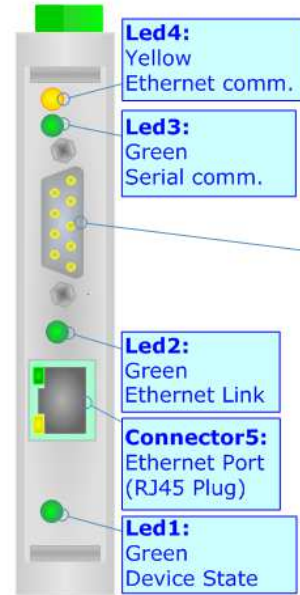

Figure 1c: Connection scheme for HD67714-MSTP-B2

**Dip-Switch A:**  
 -Dip1 – Must be at ON  
 -Dip2 – Functioning Mode  
 = Normal = Boot



**Connector1:**  
 Power Supply port  
 0V = Ground  
 +V = Positive wire  
 V AC: min 8V ; max 24V  
 V DC: min 12V ; max 35V



**Connector 4:**  
 Port RS232 (D-SUB9-Male)  
 (Isolated Port)  
 PIN2 = RX  
 PIN3 = TX  
 PIN5 = GND\* (to Isolated Ground)  
 Used for:  
 - Programmation Port  
 - Modbus on RS232  
 To connect the device to the COM port of a PC in order to set it you have to use the programming cable AC34107 or a cable made as showed here:

Figure 1d: Connection scheme for HD67714-PTP-A1

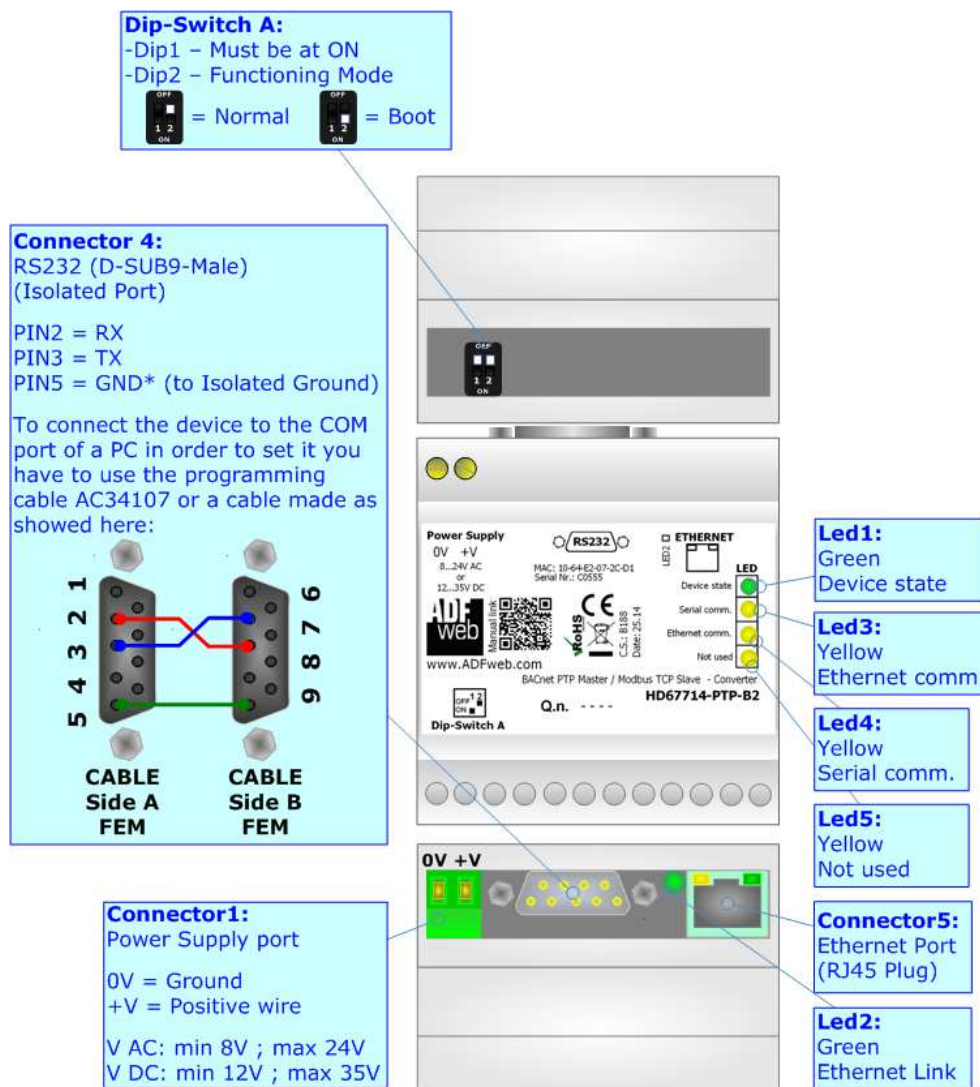

Figure 1e: Connection scheme for HD67714-PTP-B2

**CHARACTERISTICS:**

The HD67714-IP, HD67714-MSTP and the HD67714-PTP are BACnet master / Modbus TCP slave Converters.

They allow the following characteristics:

- Up to 512 BACnet objects in reading and 512 objects in writing;
- Triple isolation between RS232/485 - Power Supply, RS232/RS485 - Ethernet, Ethernet - Power Supply;
- Two-directional information between Modbus TCP bus and BACnet bus;
- Mountable on 35mm Rail DIN;
- Wide power supply input range: 8...24V AC or 12...35V DC;
- Wide temperature range: -40°C / 85°C [-40°F / +185°F].

**CONFIGURATION:**

You need Compositor SW67714 software on your PC in order to perform the following:

- Define the parameters of BACnet line;
- Define the parameters of Modbus TCP line;
- Define the BACnet data that a master read;
- Define the BACnet data that a master write;
- Update the device.

**POWER SUPPLY:**

The devices can be powered at 8...24V AC and 12...35V DC. For more details see the two tables below.

VAC		VDC	
Vmin	Vmax	Vmin	Vmax
8V	24V	12V	35V

Consumption at 24V DC:

Device	Consumption [W/VA]
HD67714-IP-A1	3.5
HD67714-MSTP-A1/B2	3.5
HD67714-PTP-A1/B2	3.5

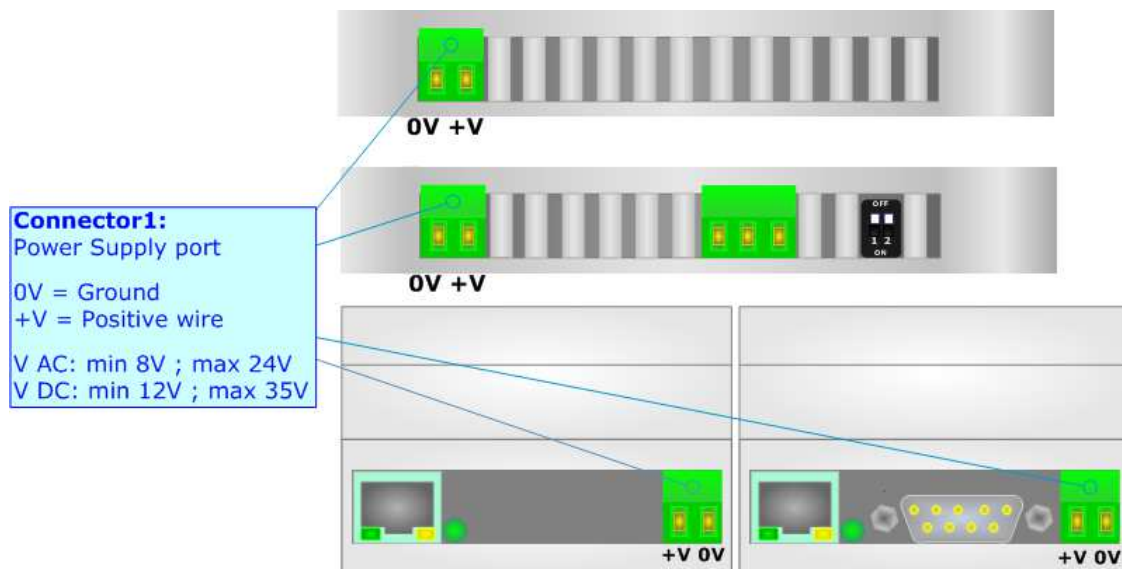

**Caution: Do not reverse the polarity power**

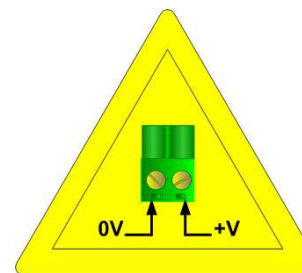

HD67714-IP-A1  
 HD67714-MSTP-A1  
 HD67714-PTP-A1

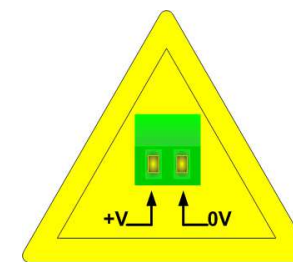

HD67714-MSTP-B2  
 HD67714-PTP-B2

**FUNCTION MODES:**

The device has got two function modes depending on the position of the 'Dip2 of Dip-Switch A':

- The first, with 'Dip2 of Dip-Switch A' at "OFF" position, is used for the normal working of the device.
- The second, with 'Dip2 of Dip-Switch A' at "ON" position, is used for uploading the Project and/or Firmware.

For the operations to follow for the updating, see 'UPDATE DEVICE' section.

According to the functioning mode, the LEDs will have specific functions, see 'LEDS' section.

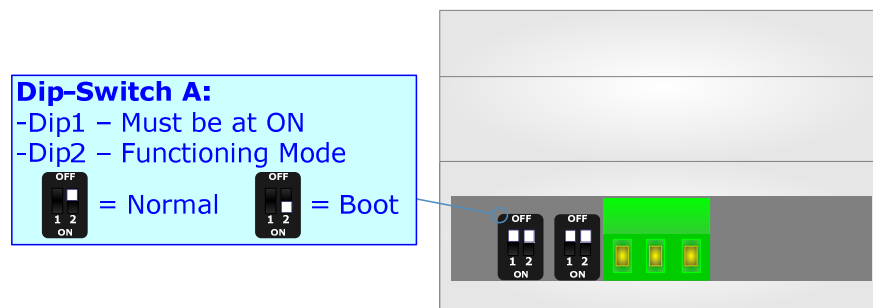

**Warning:** Dip1 of 'Dip-Switch A' must be at ON position to work even if the Ethernet cable is not inserted.

**LEDS (for HD67714-IP-A1):**

The device has got six LEDs that are used to give information about the functioning status.  
The various meanings of the LEDs are described in the table below.

LED	Normal Mode	Boot Mode
1: ON [supply voltage ] (green)	<b>ON:</b> Device powered <b>OFF:</b> Device not powered	<b>ON:</b> Device powered <b>OFF:</b> Device not powered
2: Modbus comm. (green)	Blinks when Modbus data are received	<b>Blinks quickly:</b> Boot state <b>Blinks very slowly (~0.5Hz):</b> update in progress
3: Device state (green)	Blinks slowly (~1Hz)	<b>Blinks quickly:</b> Boot state <b>Blinks very slowly (~0.5Hz):</b> update in progress
4: Not used (green)	OFF	<b>Blinks quickly:</b> Boot state <b>Blinks very slowly (~0.5Hz):</b> update in progress
5: Ethernet1 Tx (green)	Blinks when is transmitting Ethernet frames	<b>Blinks quickly:</b> Boot state <b>Blinks very slowly (~0.5Hz):</b> update in progress
6: Ethernet2 Tx (green)	Blinks when is transmitting Ethernet frames	<b>Blinks quickly:</b> Boot state <b>Blinks very slowly (~0.5Hz):</b> update in progress

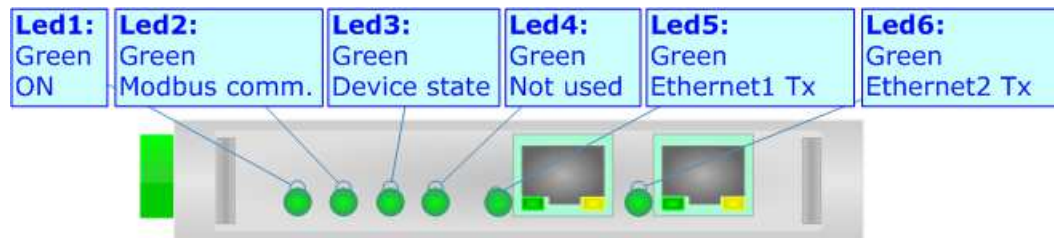

**LEDS (for HD67714-MSTP-A1/B2 and HD67714-PTP-A1/B2):**

The device has got five LEDs that are used to give information about the functioning status.  
The various meanings of the LEDs are described in the table below.

LED	Normal Mode	Boot Mode
1: Device State (green)	Blinks slowly (~1Hz)	<b>ON:</b> Device powered <b>OFF:</b> Device not powered
2: Ethernet Link (green)	<b>ON:</b> Ethernet cable connected <b>OFF:</b> Ethernet cable disconnected	<b>Blinks quickly:</b> Boot state <b>Blinks very slowly (~0.5Hz):</b> update in progress
3: Modbus comm. (green)	Blinks when Modbus data are received	<b>Blinks quickly:</b> Boot state <b>Blinks very slowly (~0.5Hz):</b> update in progress
4: Ethernet comm. (green)	Blinks when Ethernet frames (RS232/RS485) are received	<b>Blinks quickly:</b> Boot state <b>Blinks very slowly (~0.5Hz):</b> update in progress
5: Not Used	OFF	<b>Blinks quickly:</b> Boot state <b>Blinks very slowly (~0.5Hz):</b> update in progress

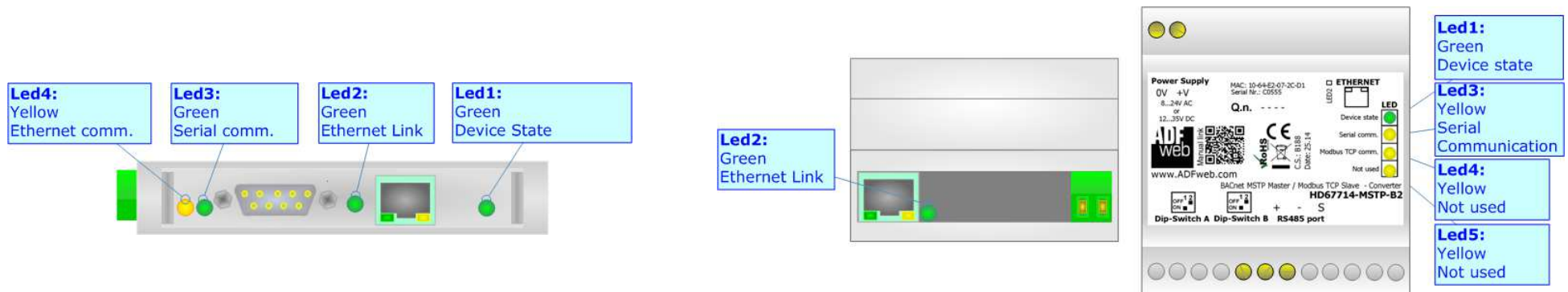



**RS485 (HD67714-MSTP-A1/B2):**

To terminate the RS485 line with a 220Ω resistor it is necessary to put ON dip 1, like in figure.

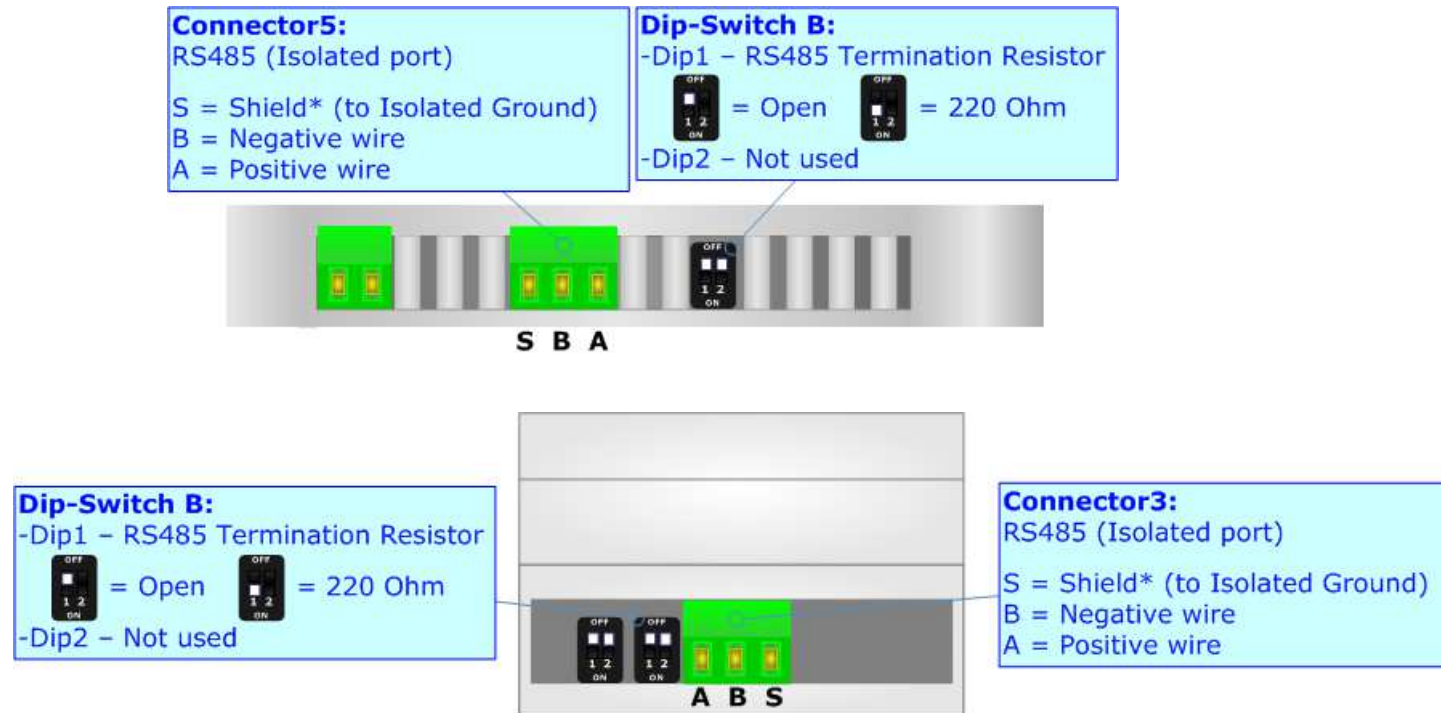

The maximum length of the cable should be 1200m (4000 feet).

Here some codes of cables:

- Belden: p/n 8132 - 2x 28AWG stranded twisted pairs conductor + foil shield + braid shield;
- Belden p/n 82842 - 2x 24AWG stranded twisted pairs conductor + foil shield + braid shield;
- Tasker: p/n C521 - 1x 24AWG twisted pair conductor + foil shield + braid shield;
- Tasker: p/n C522 - 2x 24AWG twisted pairs conductor + foil shield + braid shield.

**RS232 (HD67714-PTP-A1/B2):**

The connection from RS232 socket to a serial port (example one from a personal computer) must be made with a NULL MODEM cable (a serial cable where the pins 2 and 3 are crossed). It is recommended that the RS232 cable not exceed 15 meters.

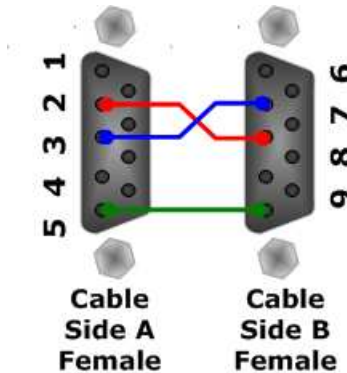

**ETHERNET:**

The BACnet/IP connection, Modbus TCP connection and the updating of the converters must be made using Connector3 and/or Connector4 and/or Connector5 of HD67714-xxx-A1/B2 with at least a Category 5E cable. The maximum length of the cable should not exceed 100m. The cable has to conform to the T568 norms relative to connections in cat.5 up to 100 Mbps. To connect the device to an Hub/Switch is recommended the use of a straight cable, to connect the device to a PC/PLC/other is recommended the use of a cross cable.



**USE OF COMPOSITOR SW67714:**

To configure the Converter, use the available software that runs with Windows called SW67714. It is downloadable on the site [www.adfweb.com](http://www.adfweb.com) and its operation is described in this document. *(This manual is referenced to the last version of the software present on our web site).* The software works with MSWindows (XP, Vista, Seven, 8; 32/64bit).

When launching the SW67714, the window below appears (Fig. 2).

**Note:**

It is necessary to have installed .Net Framework 4.

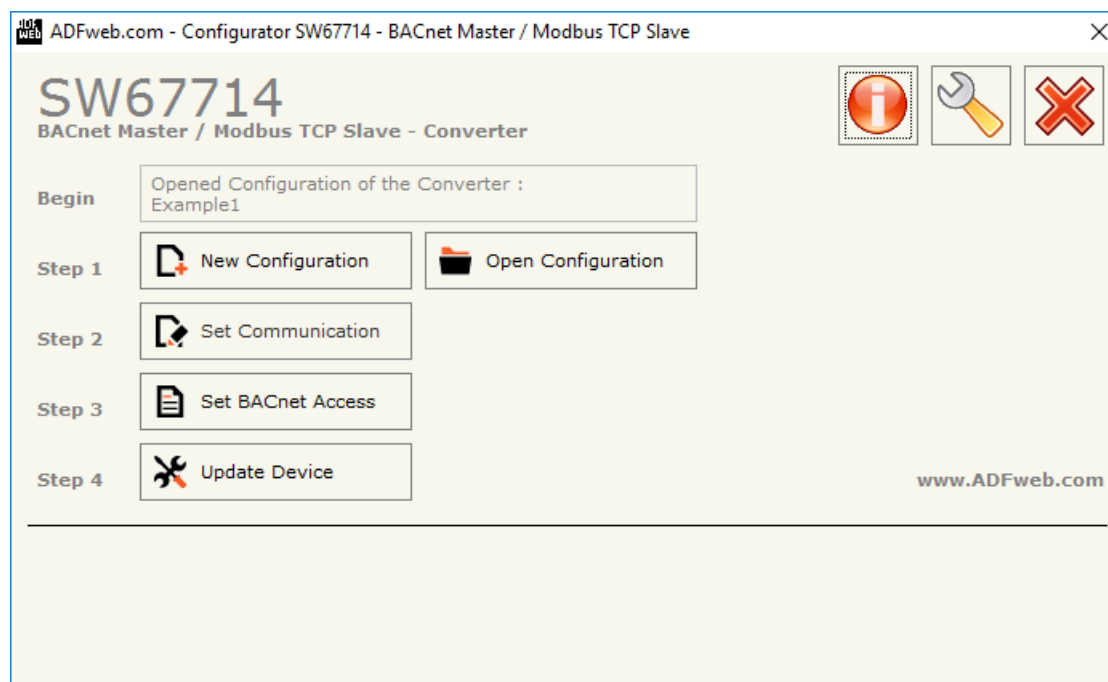
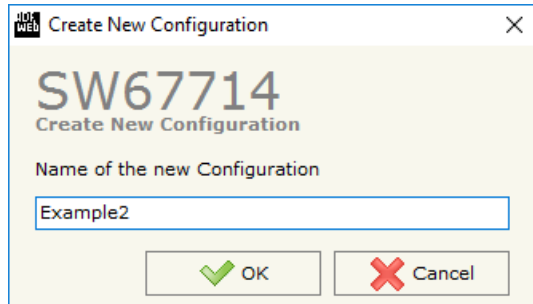

Figure 2: Main window for SW67714

**NEW CONFIGURATION / OPEN CONFIGURATION:**

The “**New Configuration**” button creates the folder which contains the entire device’s configuration.



A device’s configuration can also be imported or exported:

- To clone the configurations of a programmable “BACnet master / Modbus TCP slave - Converter” in order to configure another device in the same manner, it is necessary to maintain the folder and all its contents;
- To clone a project in order to obtain a different version of the project, it is sufficient to duplicate the project folder with another name and open the new folder with the button “**Open Configuration**”.

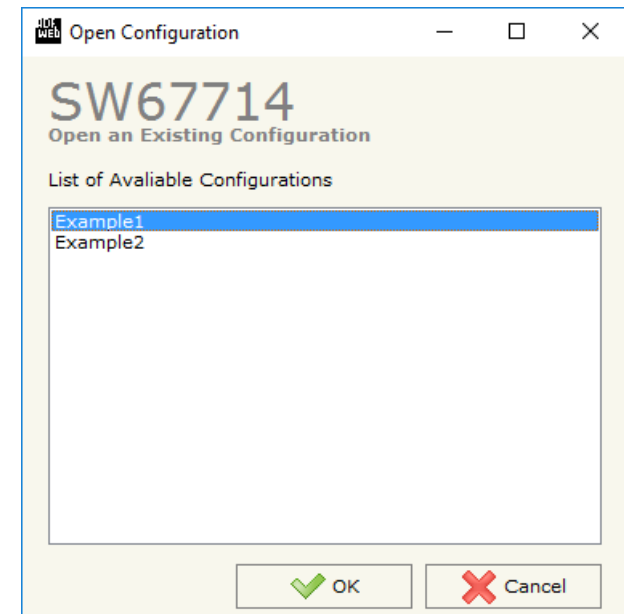

### SOFTWARE OPTIONS:

By pressing the “**Settings**” () button there is the possibility to change the language of the software and check the updatings for the compositor.

In the section “Language” it is possible to change the language of the software.

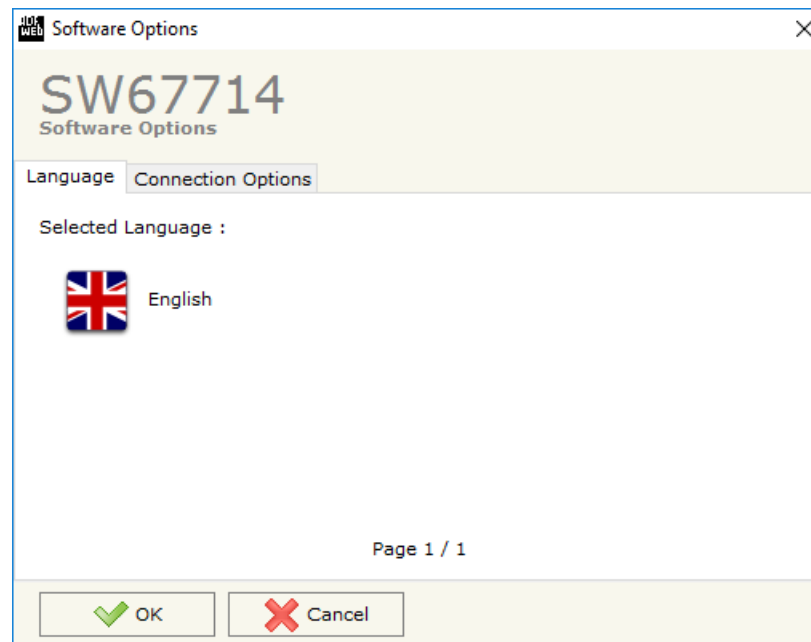
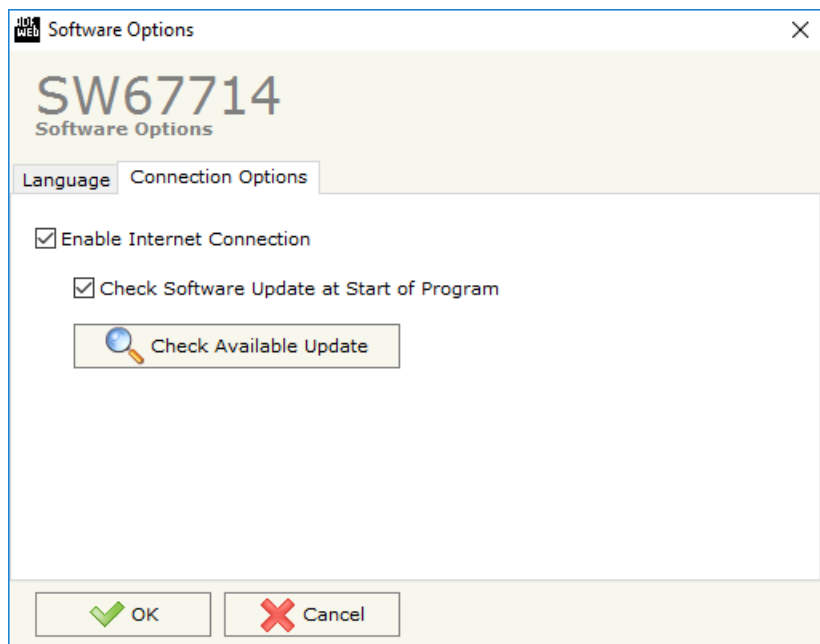

In the section “Connection Options”, it is possible to check if there are some updatings of the software compositor in ADFweb.com website. Checking the option “**Check Software Update at Start of Program**”, the SW67714 check automatically if there are updatings when it is launched.

## SET COMMUNICATION:

This section define the fundamental communication parameters of two buses, BACnet and Modbus TCP

By Pressing the **"Set Communication"** button from the main window for SW67714 (Fig. 2) the window "Set Communication" appears (Fig. 3).

In the section "BACnet Type" is possible to select the type of BACnet to use from:

- BACnet/IP (use ethernet);
- BACnet MS/TP (use RS485);
- BACnet PTP (use RS232).

If selected "BACnet/IP" the means of the fields for "BACnet" are:

- In the fields **"IP ADDRESS"** insert the IP address that you want to give to the Converter;
- In the fields **"SUBNET Mask"** insert the SubNet Mask;
- In the fields **"GATEWAY"** insert the default gateway that you want to use. This feature can be enabled or disabled pressing the Check Box field. This feature is used for going out of the net;
- In the field **"Port"** the port number used for BACnet communication is defined. The default port used for BACnet communication is 47808, but is possible to insert any value (except 10000 and 10001);
- In the field **"BACnet Device Name"** is possible to assign a name to the BACnet node;
- In the field **"Device Identifier"** is possible to assign a number to the BACnet node (Used for the Device Identifier).

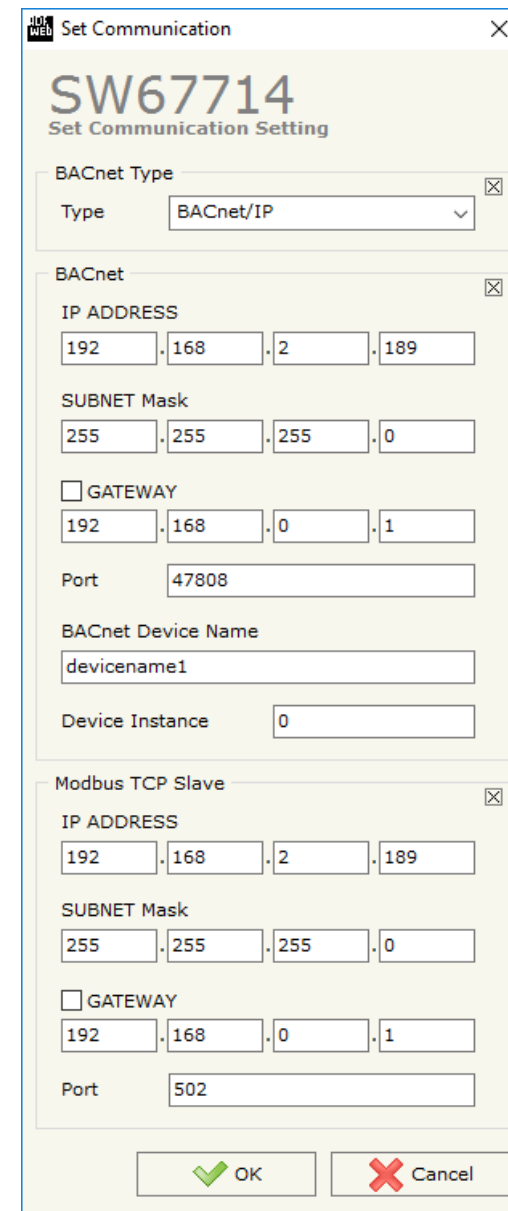

Figure 3: "Set Communication" window

The means of the fields for the "Modbus TCP Slave" section are the same for all types of BACnet:

- In the fields "**IP ADDRESS**" insert the IP address that you want to give to the Converter;
- In the fields "**SUBNET Mask**" insert the SubNet Mask;
- In the fields "**GATEWAY**" insert the default gateway that you want to use. This feature can be enabled or disabled pressing the Check Box field. This feature is used for going out of the net;
- In the field "**Port**" port number used for Modbus TCP communication is defined.

If selected "BACnet MS/TP" the means of the fields for "BACnet" are:

- In the field "**Baudrate**" it is possible to select the baudrate of the BACnet line (1200, 2400, 4800, 9600, 19200, 38400, 57600, 115200);
- In the field "**Parity**" it is possible to select the parity of the line (None, Odd, Even);
- In the field "**BACnet Device Name**" is possible to insert the name to give to the BACnet node (maximum 17 characters);
- In the field "**MAC Address**" is possible to define the MAC of BACnet node (from 0 to 254);
- The field "**Max Masters**" specifies the highest allowable address for master nodes. The value shall be less than or equal to 127;
- The field "**Max Info Frames**" specifies the maximum number of information frames the node may send before it must pass the token.

The image displays two screenshots of the "Set Communication" configuration window for device SW67714. The left screenshot shows the configuration for "BACnet PTP" (Point-to-Point) type, and the right screenshot shows the configuration for "BACnet MS/TP" (Master/Slave) type.

**Left Screenshot (BACnet PTP):**

- BACnet Type:** Type: BACnet PTP
- BACnet:** Baudrate: 9600, Parity: NONE
- BACnet Device Name:** devicename1
- Ethernet Update:** IP ADDRESS: 192.168.2.189, SUBNET Mask: 255.255.255.0, GATEWAY: 192.168.0.1
- Modbus TCP Slave:** IP ADDRESS: 192.168.2.189, SUBNET Mask: 255.255.255.0, GATEWAY: 192.168.0.1, Port: 502

**Right Screenshot (BACnet MS/TP):**

- BACnet Type:** Type: BACnet MS/TP
- BACnet:** Baudrate: 9600, Parity: NONE
- BACnet Device Name:** devicename1
- MAC Address:** 1
- Max Master:** 127
- Max Info Frames:** 100
- Device Instance:** 1
- Ethernet Update:** IP ADDRESS: 192.168.2.189, SUBNET Mask: 255.255.255.0, GATEWAY: 192.168.0.1
- Modbus TCP Slave:** IP ADDRESS: 192.168.2.189, SUBNET Mask: 255.255.255.0, GATEWAY: 192.168.0.1, Port: 502

If selected "BACnet PTP" the means of the fields for "BACnet" are:

- In the field "**Baudrate**" it is possible to select the baudrate of the BACnet line (1200, 2400, 4800, 9600, 19200, 38400, 57600, 115200);
- In the field "**Parity**" it is possible to select the parity of the line (None, Odd, Even);
- In the field "**BACnet Device Name**" is possible to insert the name to give to the BACnet node (maximum 17 characters);

The means of the fields for the "Ethernet Update" section are:

- In the fields "**IP ADDRESS**" insert the IP address that you want to give to the Converter;
- In the fields "**SUBNET Mask**" insert the SubNet Mask;
- In the fields "**GATEWAY**" insert the default gateway that you want to use. This feature can be enabled or disabled pressing the Check Box field. This feature is used for going out of the net.

These information are used for programming the Converter and for the Modbus TCP communication.



Note:

Is possible to assign the same IP address for "BACnet/IP" and "Modbus TCP". Is valid also for "Ethernet Update" and "Modbus TCP".



## SET BACNET ACCESS:

By Pressing the **"Set BACnet Access"** button from the main window of SW67714 (Fig. 2), the window "Set BACnet Access" appears (Fig. 4).

The window is divided in two parts, the **"BACnet in Read"** that contains the BACnet objects that the Converter goes to read from the slaves; and **"BACnet in Write"** that contains the BACnet objects that the Converter goes to write into the slaves.

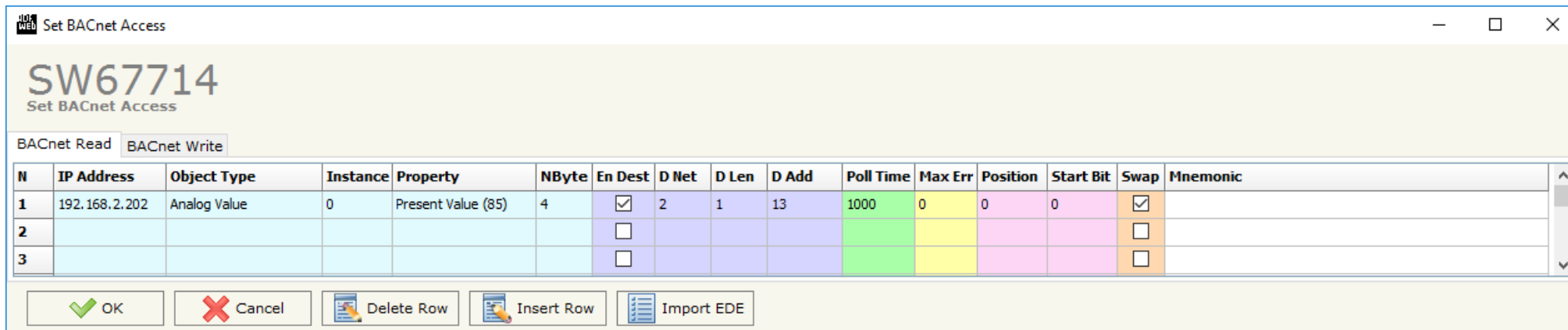

N	IP Address	Object Type	Instance	Property	NByte	En Dest	D Net	D Len	D Add	Poll Time	Max Err	Position	Start Bit	Swap	Mnemonic
1	192.168.2.202	Analog Value	0	Present Value (85)	4	<input checked="" type="checkbox"/>	2	1	13	1000	0	0	0	<input checked="" type="checkbox"/>	
2						<input type="checkbox"/>								<input type="checkbox"/>	
3						<input type="checkbox"/>								<input type="checkbox"/>	

Figure 4a: "BACnet Set Access → BACnet Read" window

The means of the fields in the window (Read) are the follows:

- In the field **"IP Address"** insert the IP address of the slave that contains the data to be read;
- In the field **"Object Type"** select the object to be read;
- In the field **"Instance"**, define the instance number of the object;
- In the field **"Property"** select the property to be read;
- In the field **"NByte"**, define the number of bytes reserved for saving the information on Modbus;
- By checking the field **"En Dest"** is possible to enable the Destination Network (D Net), Destination Length (D Len) and Destination Address (D Adr). These informations are used for make a request to other segments of network;
- In the field **"D Net"** define the destination network (from 1 to 65535);
- In the field **"D Len"** define the length of "D Add" field (1 or 2 or 6);

- In the field "**D Adr**" define the address of the endpoint. If "D Len" is one is possible to insert a number from 1 to 255; if "D Len" is two is possible to insert a number from 1 to 65535; if "D Len" is 6 is possible to insert an IP and port in this format "192.168.2.188:47808";
- In the field "**Poll Time**" define the frequency of the request;
- In the field "**Max Error**" insert the number of consecutive errors that the Master waits before discard the row from the cycle of requests;
- In the field "**Position**" is possible to select the position where save the data into a 1440 bytes array (readable by Modbus);
- The field "**Start Bit**" is used for the "Binary Input" and "Binary Output" BACnet objects. Is possible to select the position in the byte where save the data;
- By checking the field "**Swap**" is possible to swap the order of data readed from BACnet slave;
- In the field "**Mnemonic**" is possible to insert a description of the data inserted in the row.

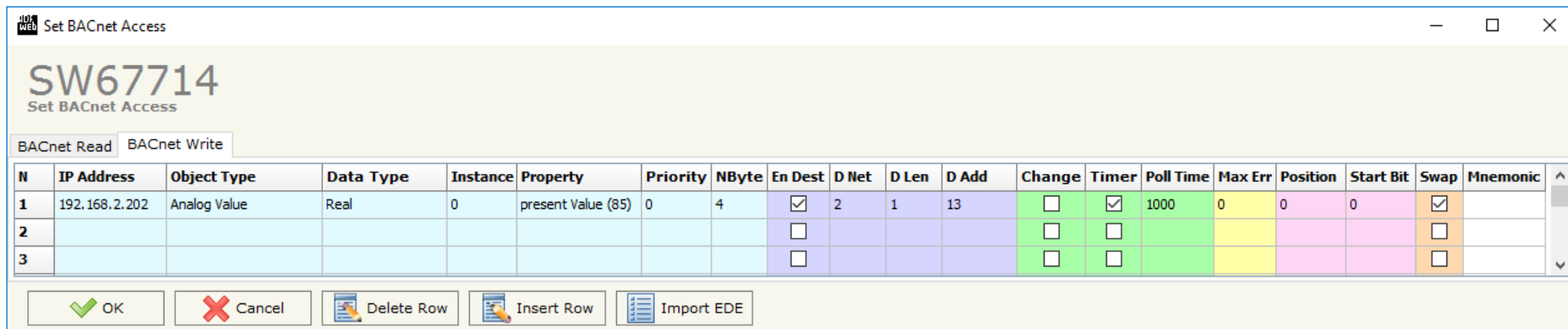

N	IP Address	Object Type	Data Type	Instance	Property	Priority	NByte	En Dest	D Net	D Len	D Add	Change	Timer	Poll Time	Max Err	Position	Start Bit	Swap	Mnemonic
1	192.168.2.202	Analog Value	Real	0	present Value (85)	0	4	<input checked="" type="checkbox"/>	2	1	13	<input type="checkbox"/>	<input checked="" type="checkbox"/>	1000	0	0	0	<input checked="" type="checkbox"/>	
2								<input type="checkbox"/>				<input type="checkbox"/>	<input type="checkbox"/>					<input type="checkbox"/>	
3								<input type="checkbox"/>				<input type="checkbox"/>	<input type="checkbox"/>					<input type="checkbox"/>	

Figure 4b: "BACnet Set Access → BACnet Write" window

The means of the fields in the window (Write) are the follows:

- In the field "**IP Address**" insert the IP address of the slave where the data are written;
- In the field "**Object Type**" select the object to be written;
- In the field "**Instance**", define the instance number of the object;
- In the field "**Property**" select the property to be written;
- In the field "**Priority**" define the priority of the frame (from 0 to 16). If is 0, means the frame doesn't contain the Priority tag.
- In the field "**NByte**", define the number of bytes sent in the request;
- By checking the field "**En Dest**" is possible to enable the Destination Network (D Net), Destination Length (D Len) and Destination Address (D Adr). These informations are used for make a request to other segments of network;
- In the field "**D Net**" define the destination network (from 1 to 65535);
- In the field "**D Len**" define the length of "D Add" field (1 or 2 or 6);
- In the field "**D Adr**" define the address of the endpoint. If "D Len" is one is possible to insert a number from 1 to 255; if "D Len" is two is possible to insert a number from 1 to 65535; if "D Len" is 6 is possible to insert an IP and port in this format "192.168.2.188:47808";
- By checking the field "**Change**" the BACnet write request is made only if Modbus data are changed; otherwise (if is selected the field "**Timer**") is sent cyclically, using the "Poll Time";
- In the field "**Poll Time**" define the frequency of the request;

- In the field "**Max Error**" insert the number of consecutive errors that the Master waits before discard the row from the cycle of requests;
- In the field "**Position**" is possible to select the position where take the data to write in the request from a 1440 bytes array (writeable by Modbus);
- The field "**Start Bit**" is used for the "Binary Output" BACnet objects. Is possible to select the position in the byte where save the data;
- By checking the field "**Swap**" is possible to swap the order of data written to the BACnet slave;
- In the field "**Mnemonic**" is possible to insert a description of the data inserted in the row.

### UPDATE DEVICE:

By pressing the **“Update Device”** button, it is possible to load the created Configuration into the device; and also the Firmware, if necessary.

If you don't know the actual IP address of the device you have to use this procedure:

- Turn off the Device;
- Put Dip2 of 'Dip-Switch A' in ON position;
- Turn on the device
- Connect the Ethernet cable;
- Insert the IP **“192.168.2.205”**;
- Press the **“Ping”** button, “Device Found! must appear”;
- Press the **“Next”** button;
- Select which operations you want to do;
- Press the **“Execute update firmware”** button to start the upload;
- When all the operations are “OK” turn off the Device;
- Put Dip2 of 'Dip-Switch A' in OFF position;
- Turn on the device.

At this point the configuration/firmware on the device is correctly updated.

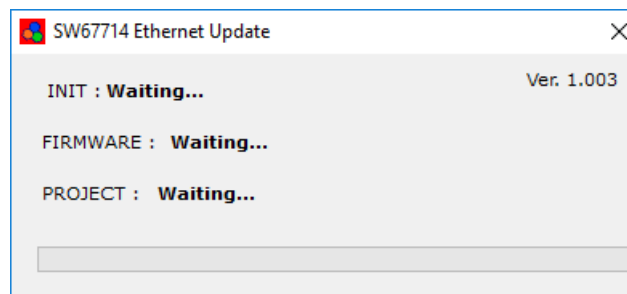
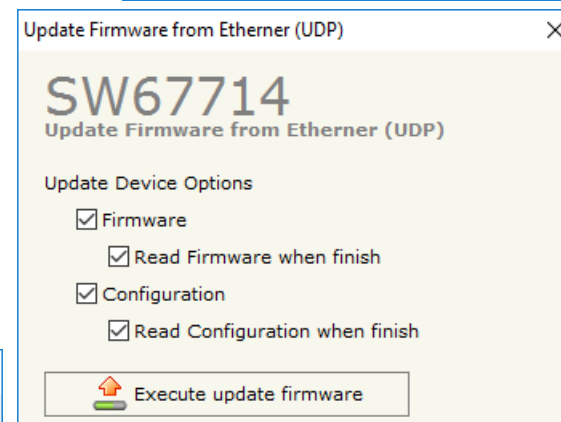
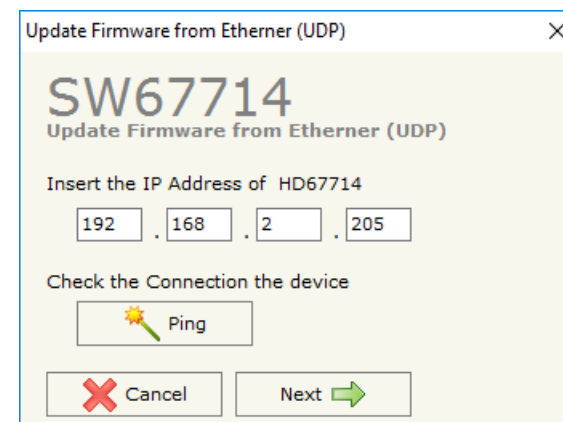

Figure 4: “Update device” windows

If you know the actual IP address of the device, you have to use this procedure:

- Turn on the Device with the Ethernet cable inserted;
- Insert the actual IP of the Converter;
- Press the "Ping" button, must appear "Device Found!";
- Press the "Next" button;
- Select which operations you want to do;
- Press the "Execute update firmware" button to start the upload;
- When all the operations are "OK" the device automatically goes at Normal Mode.

At this point the configuration/firmware on the device is correctly update.



**Note:**

When you install a new version of the software, if it is the first time it is better you do the update of the Firmware in the HD67714 device.



**Note:**

When you receive the device, for the first time, you also have to update the Firmware in the HD67714 device.



**Warning:**

If Fig. 6 appears when you try to do the Update try these points before seeking assistance:

- Try to repeat the operations for the update;
- Try with another PC;
- Try to restart the PC;
- If you are using the program inside a Virtual Machine, try to use it in the main Operating System;
- If you are using Windows Seven or Vista or 8, make sure that you have the administrator privileges;
- Pay attention to the Firewall lock;
- Check the LAN settings.



In the case of HD67714 you have to use the software "SW67714": [www.adfweb.com/download/filefold/SW67714.zip](http://www.adfweb.com/download/filefold/SW67714.zip).

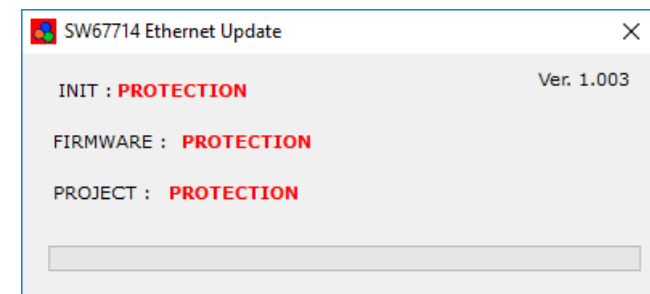
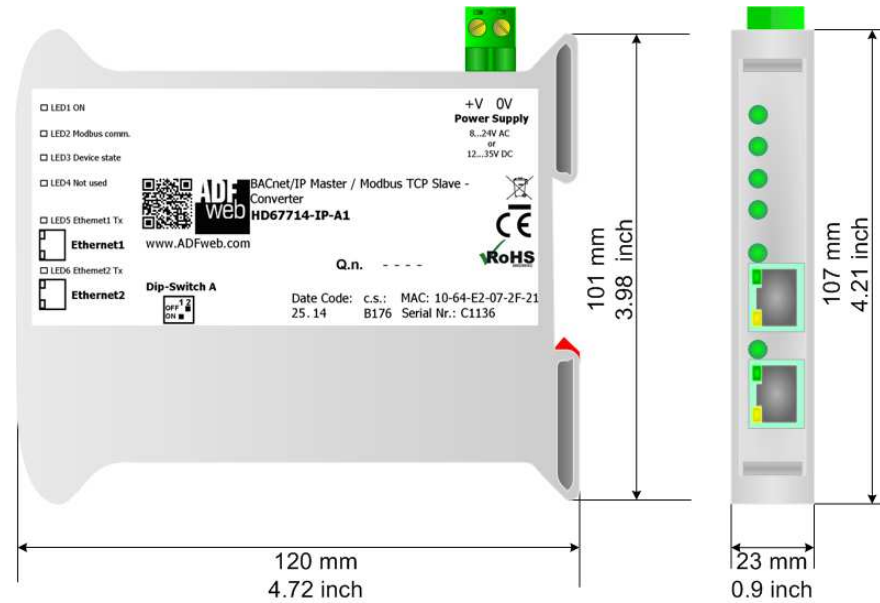

Figure 5: "Protection" window

**MECHANICAL DIMENSIONS:**



Housing: PVC  
Weight: 200g (Approx)

*Figure 6a: Mechanical dimensions scheme for HD67714-IP-A1*

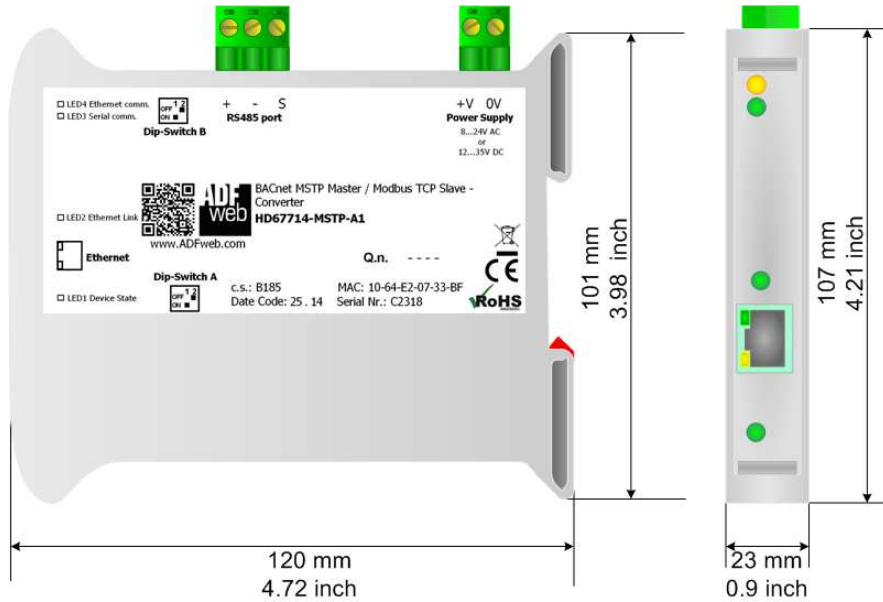

Housing: PVC  
Weight: 200g (Approx)

Figure 6b: Mechanical dimensions scheme for HD67714-MSTP-A1

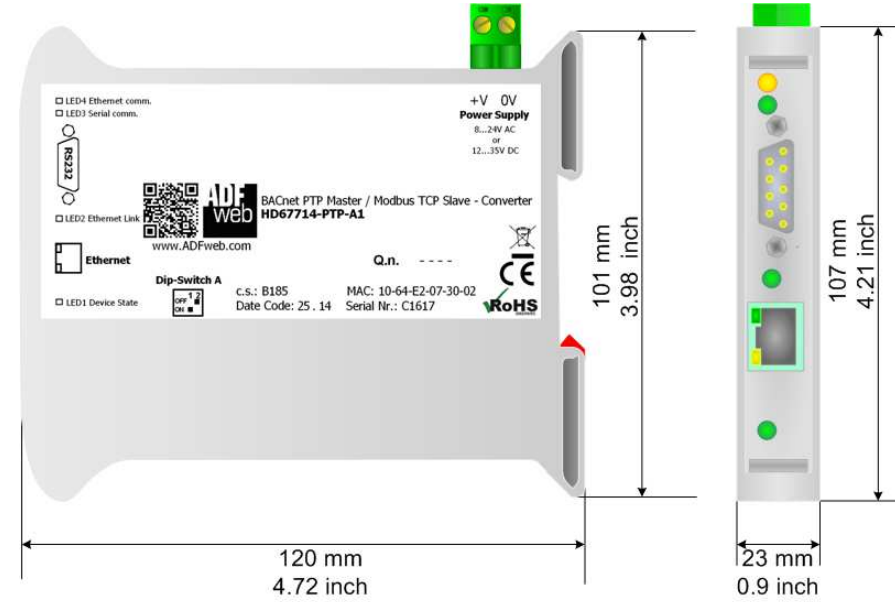

Housing: PVC  
Weight: 200g (Approx)

Figure 6c: Mechanical dimensions scheme for HD67714-PTP-A1



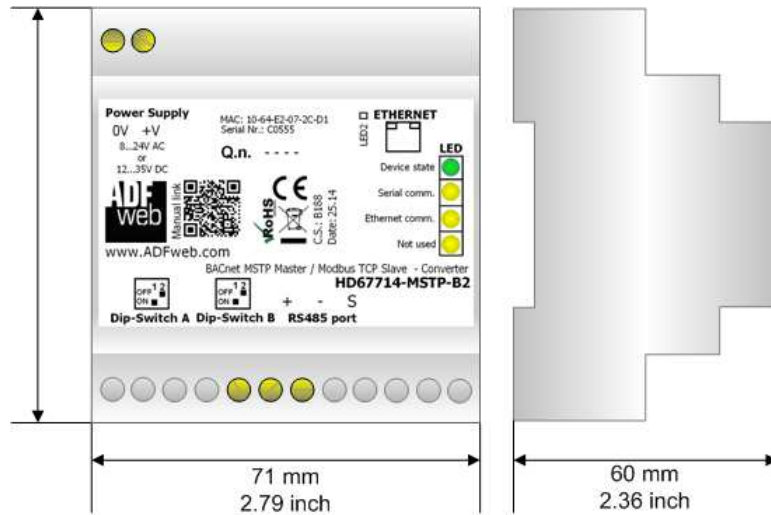

Housing: PVC  
Weight: 200g (Approx)

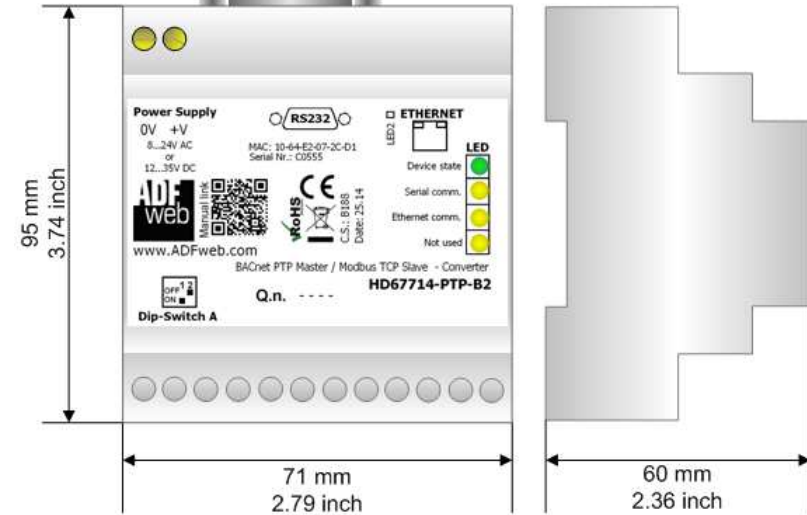

Housing: PVC  
Weight: 200g (Approx)

Figure 6d: Mechanical dimensions scheme for HD67714-MSTP-B2

Figure 6e: Mechanical dimensions scheme for HD67714-PTP-B2

## ORDERING INFORMATIONS:

The ordering part number is formed by a valid combination of the following:

**HD67714 - xxx - xx**

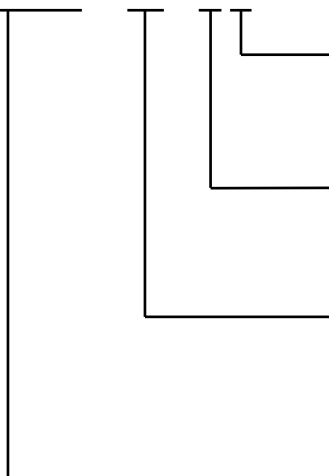

### Connectors Type

- 1: Removable 5mm Screw Terminal
- 2: Fixed 5mm Screw Terminal

### Enclosure Type

- A: 1M, 35mm DIN Rail mounting
- B: 4M, 35mm DIN Rail mounting

### BACnet type

- IP: BACnet/IP
- MSTP: BACnet MSTP
- PTP: BACnet PTP

### Device Family

HD67714: BACnet Master / Modbus TCP Slave - Converter

- |                                    |   |   |
|------------------------------------|---|---|
| Order Code: <b>HD67714-IP-A1</b>   | - | BACnet/IP Master / Modbus TCP Slave – Converter   |
| Order Code: <b>HD67714-MSTP-A1</b> | - | BACnet MSTP Master / Modbus TCP Slave – Converter |
| Order Code: <b>HD67714-MSTP-B2</b> | - | BACnet MSTP Master / Modbus TCP Slave - Converter |
| Order Code: <b>HD67714-PTP-A1</b>  | - | BACnet PTP Master / Modbus TCP Slave - Converter  |
| Order Code: <b>HD67714-PTP-B2</b>  | - | BACnet PTP Master / Modbus TCP Slave - Converter  |

## ACCESSORIES:

- |                            |   |  |
|----------------------------|---|--|
| Order Code: <b>AC34001</b> | - | 35mm Rail DIN - Power Supply 220/240V AC 50/60Hz – 12 V AC |
| Order Code: <b>AC34002</b> | - | 35mm Rail DIN - Power Supply 110V AC 50/60Hz – 12 V AC     |

**DISCLAIMER:**

All technical content within this document can be modified without notice. The content of the document is a under continual renewal. For losses due to fire, earthquake, third party access or other accidents, or intentional or accidental abuse, misuse, or use under abnormal conditions repairs are charged to the user. ADFweb.com S.r.l. will not be liable for accidental loss of use or inability to use this product, such as loss of business income. ADFweb.com S.r.l. shall not be liable for consequences of improper use.

**OTHER REGULATIONS AND STANDARDS:****WEEE INFORMATION**

Disposal of old electrical and electronic equipment (as in the European Union and other European countries with separate collection systems).

— This symbol on the product or on its packaging indicates that this product may not be treated as household rubbish. Instead, it should be taken to an applicable collection point for the recycling of electrical and electronic equipment. If the product is disposed correctly, you will help prevent potential negative environmental factors and impact of human health, which could otherwise be caused by inappropriate disposal. The recycling of materials will help to conserve natural resources. For more information about recycling this product, please contact your local city office, your household waste disposal service or the shop where you purchased the product.

**RESTRICTION OF HAZARDOUS SUBSTANCES DIRECTIVE**

The device respects the 2002/95/EC Directive on the restriction of the use of certain hazardous substances in electrical and electronic equipment (commonly referred to as Restriction of Hazardous Substances Directive or RoHS).

**CE MARKING**

The product conforms with the essential requirements of the applicable EC directives.

**WARRANTIES AND TECHNICAL SUPPORT:**

For fast and easy technical support for your ADFweb.com SRL products, consult our internet support at [www.adfweb.com](http://www.adfweb.com). Otherwise contact us at the address [support@adfweb.com](mailto:support@adfweb.com)

**RETURN POLICY:**

If while using your product you have any problem and you wish to exchange or repair it, please do the following:

- Obtain a Product Return Number (PRN) from our internet support at [www.adfweb.com](http://www.adfweb.com). Together with the request, you need to provide detailed information about the problem.
- Send the product to the address provided with the PRN, having prepaid the shipping costs (shipment costs billed to us will not be accepted).

If the product is within the warranty of twelve months, it will be repaired or exchanged and returned within three weeks. If the product is no longer under warranty, you will receive a repair estimate.



**ADFweb.com S.r.l.**  
Via Strada Nuova, 17  
IT-31010 Mareno di Piave  
TREVISO (Italy)  
Phone +39.0438.30.91.31  
Fax +39.0438.49.20.99  
[www.adfweb.com](http://www.adfweb.com)

