

User Manual

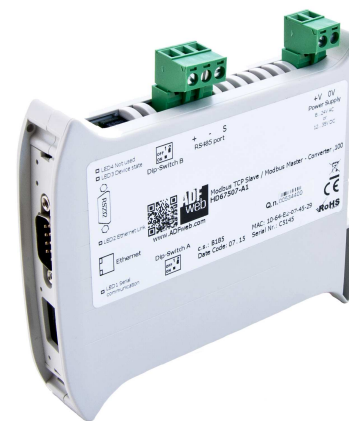

User Manual

INDEX:

	Page
INDEX	2
UPDATED DOCUMENTATION	2
REVISION LIST	2
WARNING	2
TRADEMARKS	2
SECURITY ALERT	3
EXAMPLE OF CONNECTION	4
CONNECTION SCHEME	5
CHARACTERISTICS	7
CONFIGURATION	7
POWER SUPPLY	8
FUNCTION MODES	9
LEDS	10
CANOPEN	11
ETHERNET	12
USE OF COMPOSITOR SW67504	13
NEW PROJECT / OPEN PROJECT	14
SOFTWARE OPTIONS	15
SET COMMUNICATION	16
SDO SETTING	18
SDO SETTING STATUS	19
PDO SETTING	20
PDO SETTING STATUS	21
EDS FILE	22
UPDATE DEVICE	23
MECHANICAL DIMENSIONS	26
ORDER CODES	27
ACCESSORIES	27
DISCLAIMER	28
OTHER REGULATIONS AND STANDARDS	28
WARRANTIES AND TECHNICAL SUPPORT	29
RETURN POLICY	29

UPDATED DOCUMENTATION:

Dear customer, we thank you for your attention and we remind you that you need to check that the following document is:

- Updated
- Related to the product you own

To obtain the most recently updated document, note the “document code” that appears at the top right-hand corner of each page of this document.

With this “Document Code” go to web page www.adfweb.com/download/ and search for the corresponding code on the page. Click on the proper “Document Code” and download the updates.

REVISION LIST:

Revision	Date	Author	Chapter	Description
1.000	09/07/2004	Dp	All	First release version
1.010	14/11/2011	Fl	All	Software changed (v1.100)
1.011	07/02/2013	Nt	All	Added new chapters
1.100	24/06/2016	Ff	All	New hardware version

WARNING:

ADFweb.com reserves the right to change information in this manual about our product without warning. ADFweb.com is not responsible for any error this manual may contain.

TRADEMARKS:

All trademarks mentioned in this document belong to their respective owners.

SECURITY ALERT:**GENERAL INFORMATION**

To ensure safe operation, the device must be operated according to the instructions in the manual. When using the device are required for each individual application, legal and safety regulation. The same applies also when using accessories.

INTENDED USE

Machines and systems must be designed so the faulty conditions do not lead to a dangerous situation for the operator (i.e. independent limit switches, mechanical interlocks, etc.).

QUALIFIED PERSONNEL

The device can be used only by qualified personnel, strictly in accordance with the specifications. Qualified personnel are persons who are familiar with the installation, assembly, commissioning and operation of this equipment and who have appropriate qualifications for their job.

RESIDUAL RISKS

The device is state of the art and is safe. The instrument can represent a potential hazard if they are inappropriately installed and operated by personnel untrained. These instructions refer to residual risks with the following symbol:

 This symbol indicates that non-observance of the safety instructions is danger for people to serious injury or death and / or the possibility of damage.

CE CONFORMITY

The declaration is made by us. You can send an email to or give us a call if you need it.

EXAMPLE OF CONNECTION:

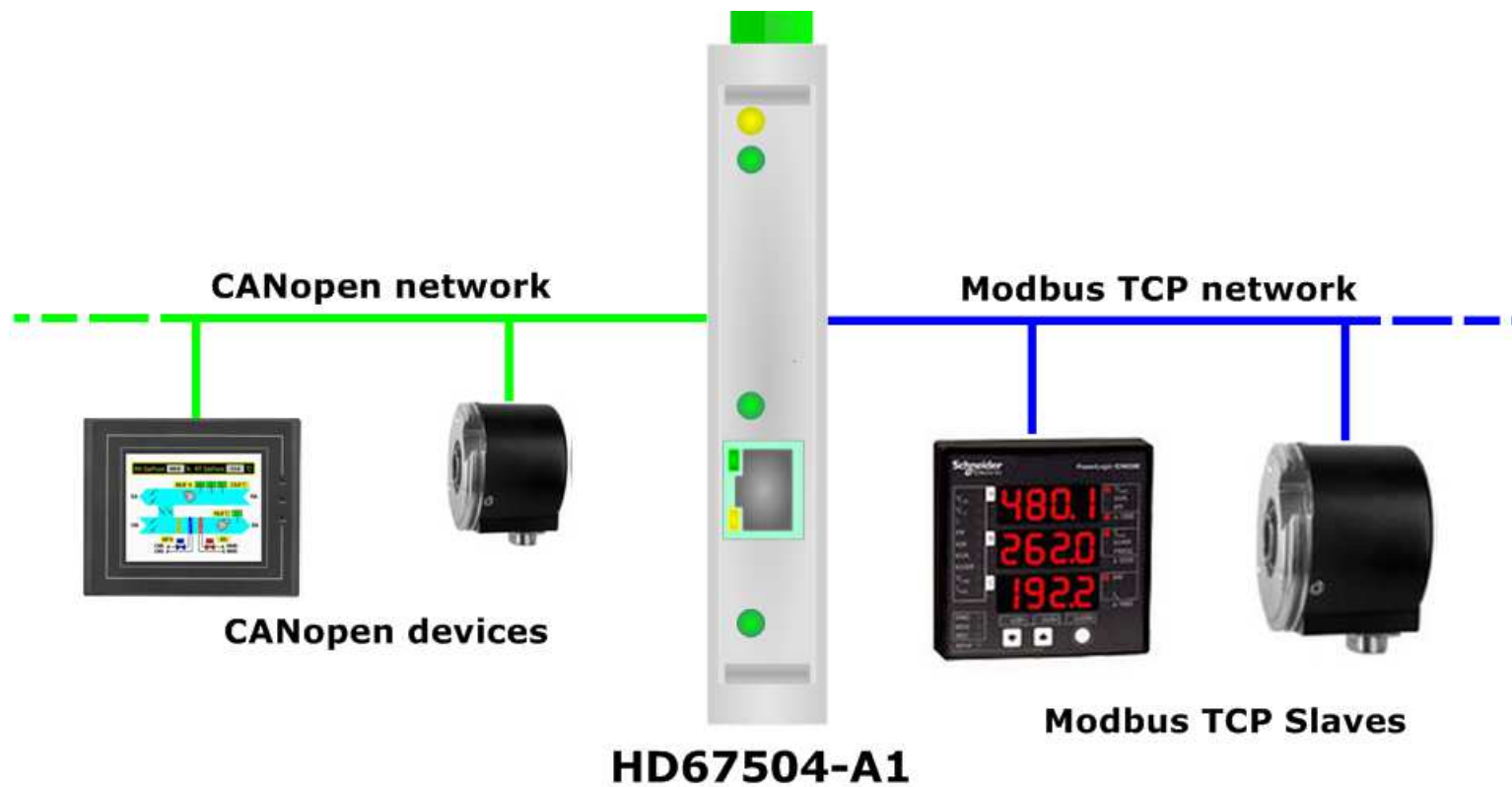

CONNECTION SCHEME:

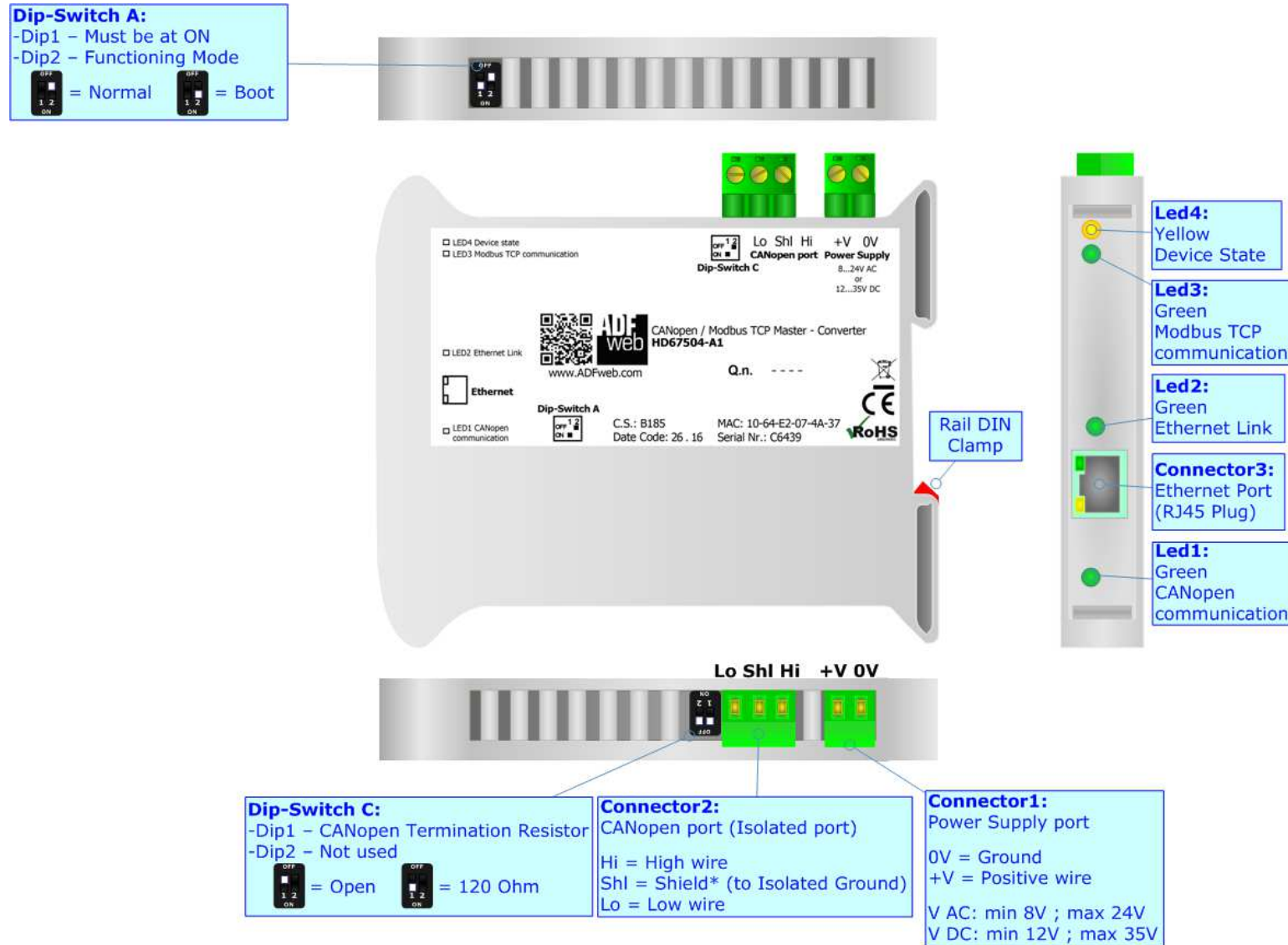

Figure 1a: Connection scheme for HD67504-A1

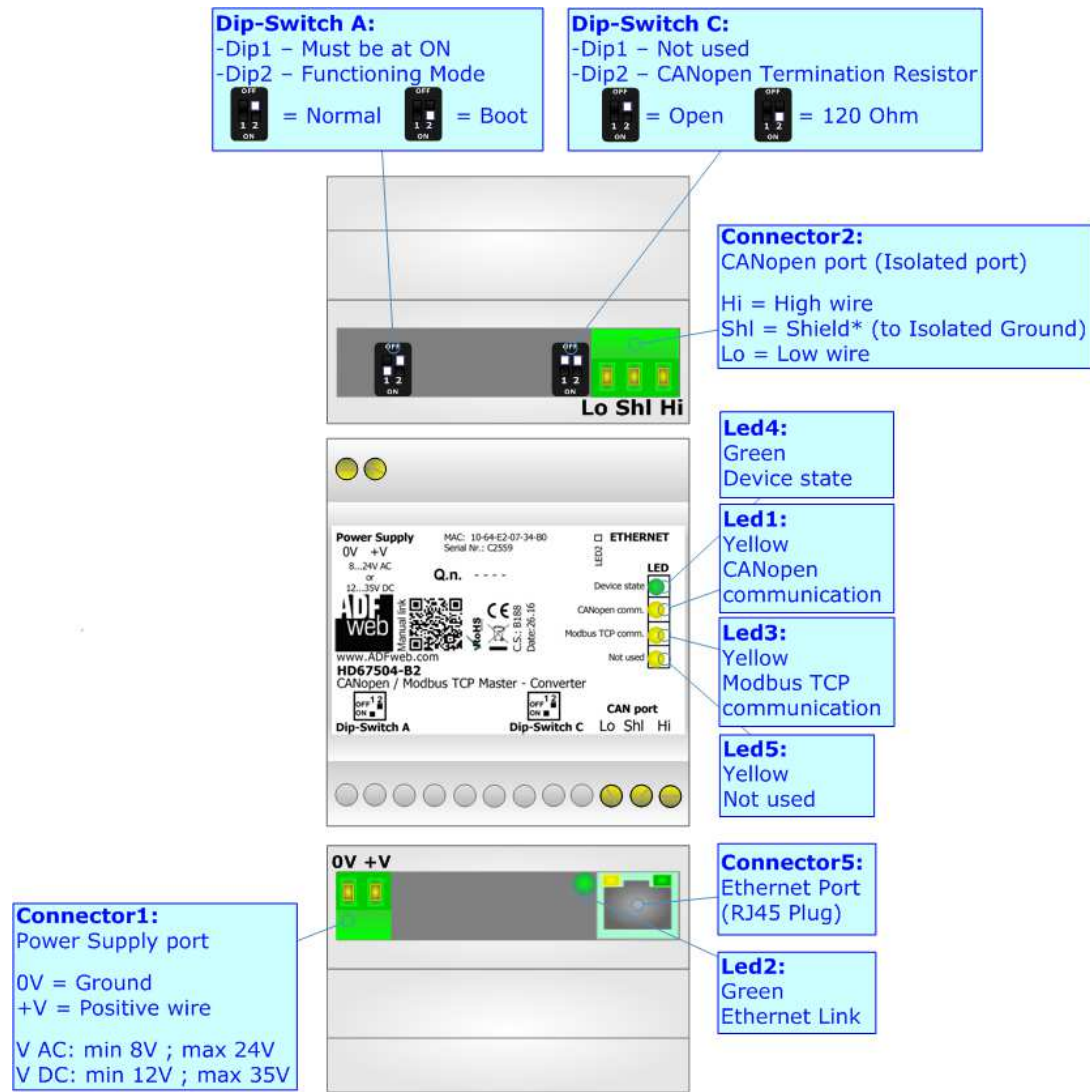

Figure 1b: Connection scheme for HD67504-B2

CHARACTERISTICS:

The "CANopen / Modbus TCP Master – Converter" allows the following characteristics:

- two-directional information between networks CANopen and Modbus TCP;
- electrical isolation between Ethernet – CAN, Power Supply – Ethernet, Power Supply – CAN;
- Mountable on Rail DIN;
- Wide power supply input range: 8...24V AC or 12...35V DC;
- Wide temperature range: -40°C / 85°C [-40°F / +185°F].

CONFIGURATION:

You need Compositor SW67504 software on your PC in order to perform the following:

- Define the parameter of CANopen;
- Define the parameter of Modbus TCP;
- Define CANopen frames with which it is possible to read Modbus data;
- Define CANopen frames with which it is possible to write Modbus data;
- Update the device.

POWER SUPPLY:

The devices can be powered at 8...24V AC and 12...35V DC. The consumption depends to the code of the device. For more details see the two tables below.

VAC		VDC	
Vmin	Vmax	Vmin	Vmax
8V	24V	12V	35V

Consumption at 24V DC:

Device	Consumption [W/VA]
HD67504-A1	3.5
HD67504-B2	3.5

Caution: Not reverse the polarity power

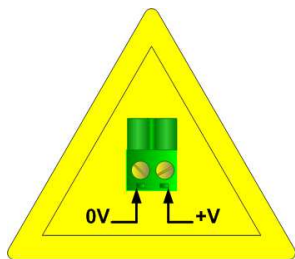

HD67504-A1

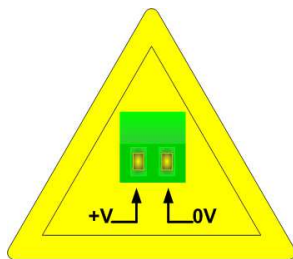

HD67504-B2

Connector1:
Power Supply port
0V = Ground
+V = Positive wire
V AC: min 8V ; max 24V
V DC: min 12V ; max 35V



0V +V

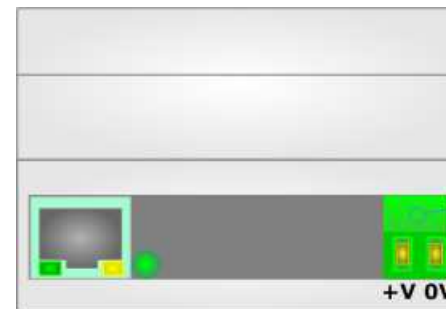

Connector1:
Power Supply port
0V = Ground
+V = Positive wire
V AC: min 8V ; max 24V
V DC: min 12V ; max 35V

+V 0V

FUNCTION MODES:

The device has got two function modes depending on the position of the 'Dip2 of Dip-Switch A':

- The first, with 'Dip2 of Dip-Switch A' at "OFF" position, is used for the normal working of the device.
- The second, with 'Dip2 of Dip-Switch A' at "ON" position, is used for uploading the Project and/or Firmware.

For the operations to follow for the updating, see 'UPDATE DEVICE' section.

According to the functioning mode, the LEDs will have specific functions, see 'LEDS' section.

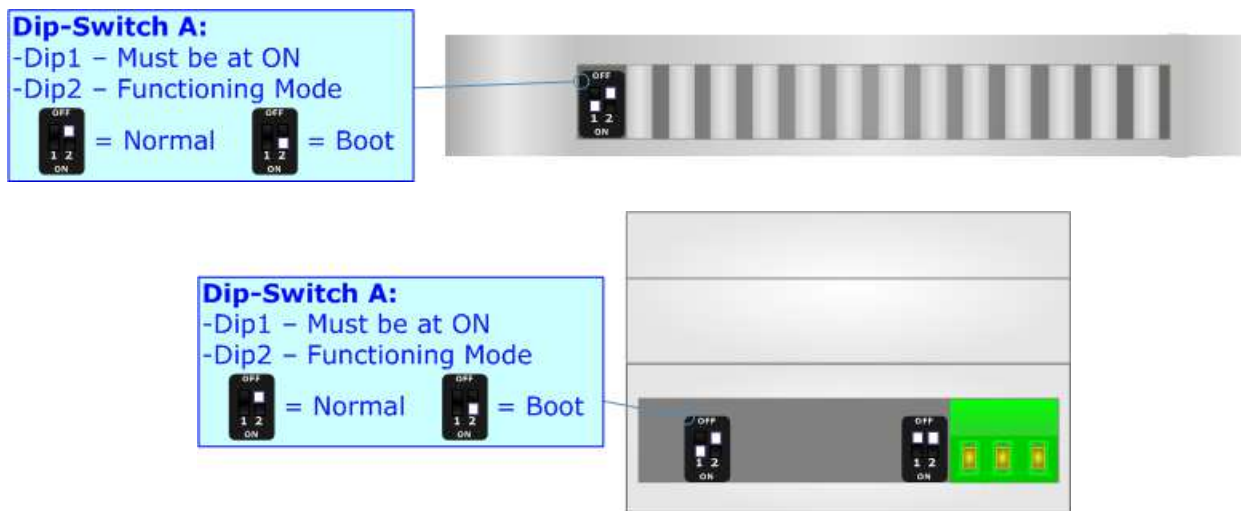

Warning:

Dip1 of 'Dip-Switch A' must be at ON position to work even if the Ethernet cable is not inserted.

LEDS:

The devices has got four (five for HD67504-B2) LEDs that are used to give information of the functioning status. The various meanings of the LEDs are described in the table below.

LED	Normal Mode	Boot Mode
1: CANopen communication (green)	Blinks when CANopen frames are received	Blinks quickly: Boot state Blinks very slowly (~0.5Hz): update in progress
2: Ethernet Link (green)	ON: Ethernet cable connected OFF: Ethernet cable disconnected	ON: Ethernet cable connected OFF: Ethernet cable disconnected
3: Modbus TCP communication (green)	Blinks when Modbus TCP frames are received	Blinks quickly: Boot state Blinks very slowly (~0.5Hz): update in progress
4: Device State (yellow)	Blinks slowly (~1Hz)	Blinks quickly: Boot state Blinks very slowly (~0.5Hz): update in progress
5: Not used (yellow) (Present only on HD67504-B2)	OFF	Blinks quickly: Boot state Blinks very slowly (~0.5Hz): update in progress

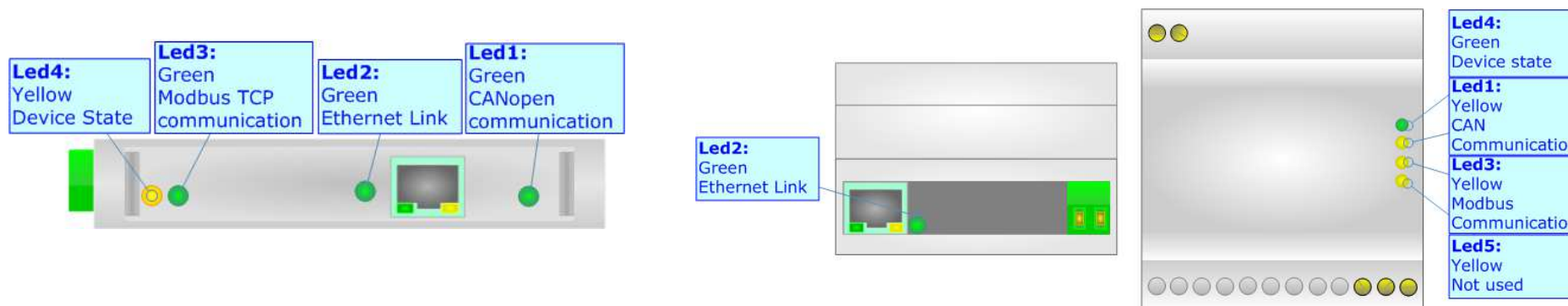

CAN:

For terminating the CAN line with a 120Ω resistor it is necessary that the Dip1 of 'Dip-Switch C' is at ON position (for HD67504-A1) or that the Dip2 of 'Dip-Switch C' is at ON position (for HD67504-B2).

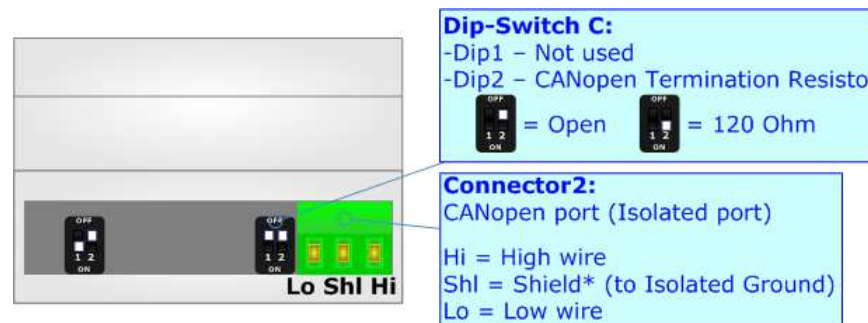
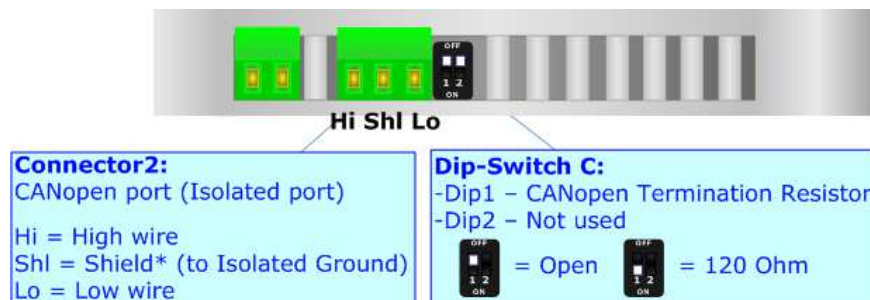

Cable characteristics:

DC parameter:	Impedance	70 Ohm/m
AC parameters:	Impedance	120 Ohm/m
	Delay	5 ns/m
Length	Baud Rate [bps]	Length MAX [m]
	10 K	5000
	20 K	2500
	50 K	1000
	100 K	650
	125 K	500
	250 K	250
	500 K	100
	800 K	50
	1000 K	25

ETHERNET:

The Ethernet connection must be made using Connector5 of HD67504-A1/HD67504-B2 with at least a Category 5E cable. The maximum length of the cable should not exceed 100m. The cable has to conform to the T568 norms relative to connections in cat.5 up to 100 Mbps. To connect the device to a Hub/Switch the use of a straight cable is recommended. To connect the device to a PC/PLC/other the use of a cross cable is recommended.



USE OF COMPOSITOR SW67504:

To configure the Converter, use the available software that runs with Windows called SW67504. It is downloadable on the site www.adfweb.com and its operation is described in this document. *(This manual is referenced to the last version of the software present on our web site)*. The software works with MSWindows (XP, Vista, Seven, 8, 10; 32/64bit).

When launching the SW67504, the window below appears (Fig. 2).



Note:

It is necessary to have installed .Net Framework 4.

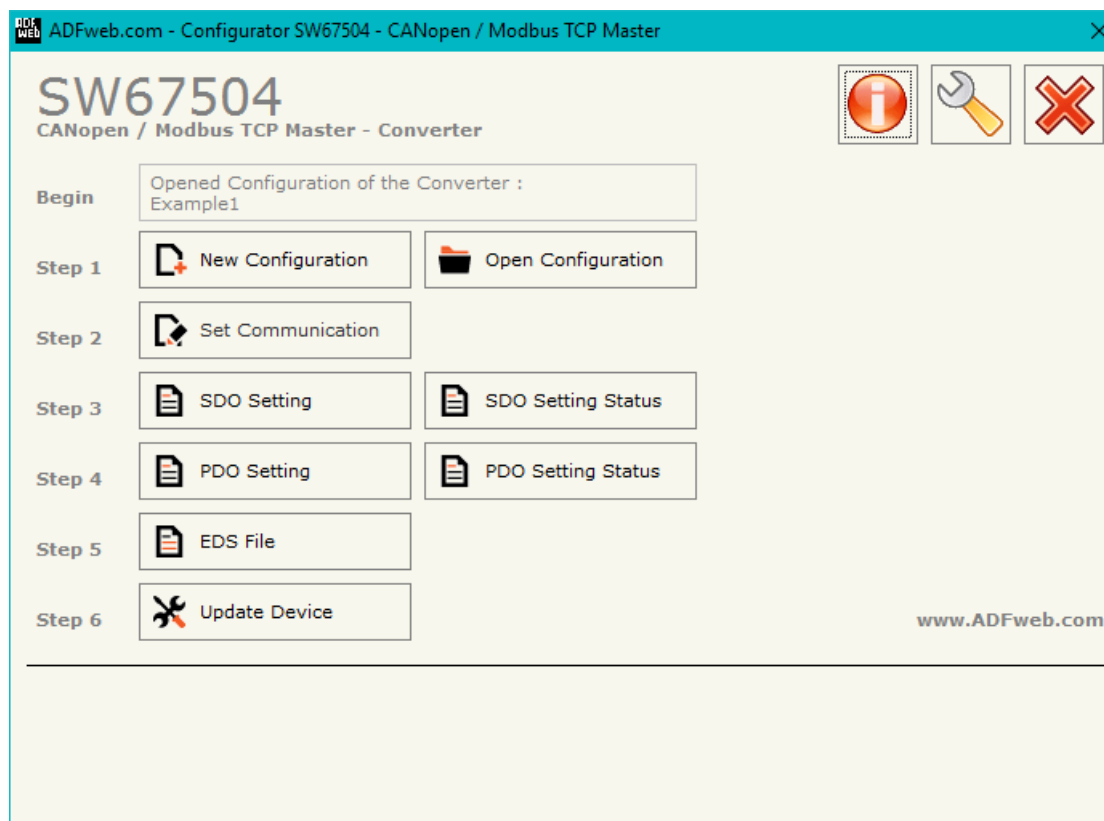
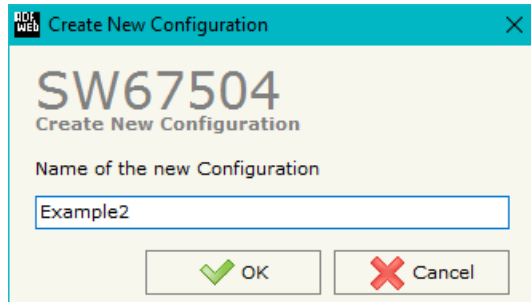

Figure 2: Main window for SW67504

NEW CONFIGURATION / OPEN CONFIGURATION:

The “**New Configuration**” button creates the folder which contains the entire device’s configuration.



A device’s configuration can also be imported or exported:

- To clone the configurations of a programmable “CANopen / Modbus TCP Master - Converter” in order to configure another device in the same manner, it is necessary to maintain the folder and all its contents;
- To clone a project in order to obtain a different version of the project, it is sufficient to duplicate the project folder with another name and open the new folder with the button “**Open Configuration**”.

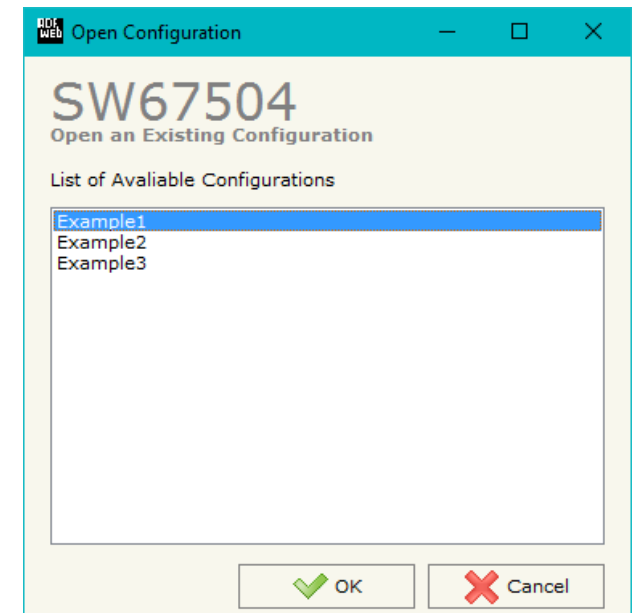

SOFTWARE OPTIONS:

By pressing the “**Settings**” () button there is the possibility to change the language of the software and check the updatings for the compositor.

In the section “Language” it is possible to change the language of the software.

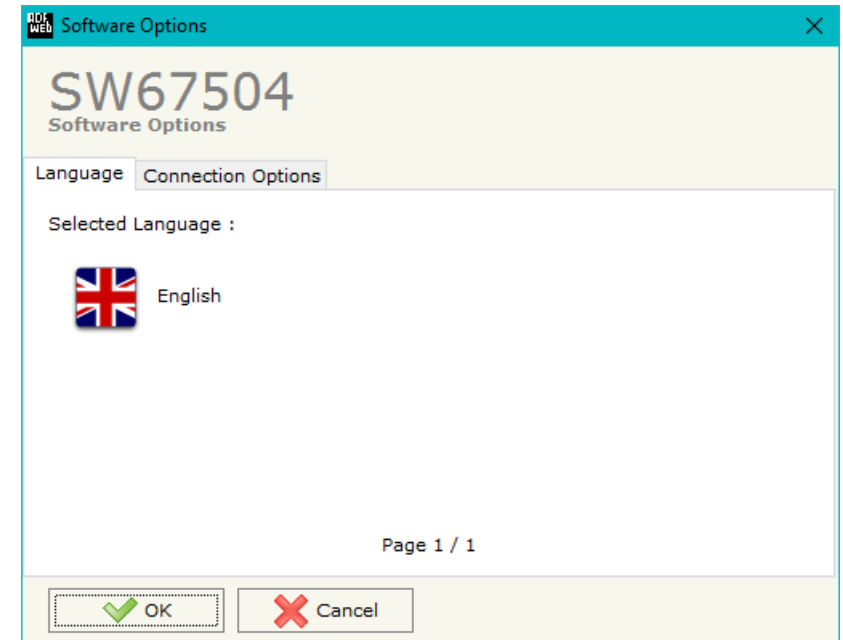
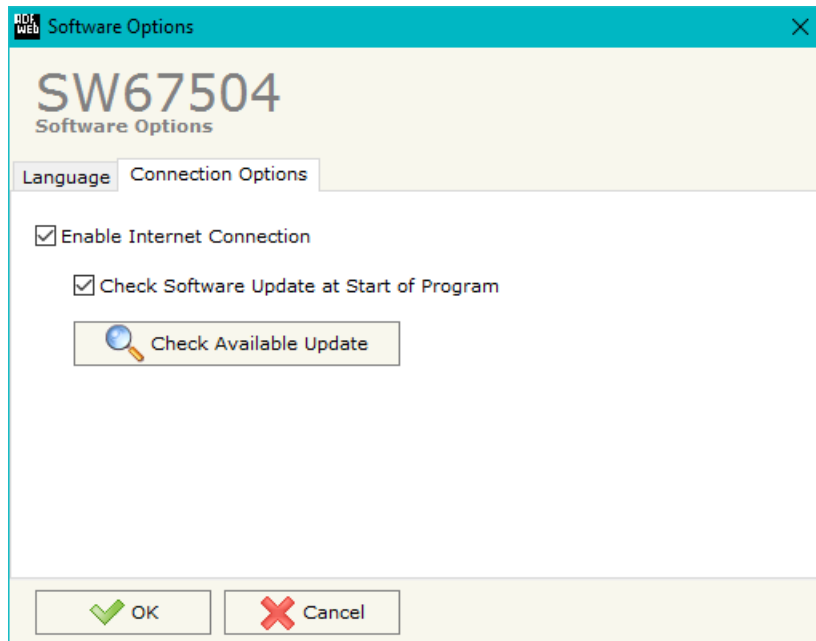

In the section “Connection Options”, it is possible to check if there are some updatings of the software compositor in ADFweb.com website. Checking the option “**Check Software Update at Start of Program**”, the SW67504 check automatically if there are updatings when it is launched.

SET COMMUNICATION:

This section defines the fundamental communication parameters of two Buses, CANopen and Modbus TCP.

By pressing the **Set Communication** button from the main window for SW67504 (Fig. 2) the window "Set communication" appears (Fig. 3).

This window is divided in two sections, one for configure the CANopen Network and the other for the Modbus TCP Master.

In the section "Select Device" it is possible to select the type of converter used:

- Hardware with Jumper;
- Hardware with Dip-Switch.

The means for the fields for the "CANopen" are:

- In the field **Device ID** the ID for the CANopen side is defined;
- In the field **Baudrate** the baudrate for the CANopen is defined;
- In the field **Set Operational State at Start-up** the state of the CANopen is defined. I.e. if it is checked the board starts in Operational State, else it starts in Pre-Operational;
- In the field **Network Start at Start-up** the state of the network CANopen is defined. I.e. if it is checked the board sends a command to set the Operational State for all the devices present in the network;
- In the field **Delay** the delay before sending the network start command for the CANopen is defined;
- If the field **Send Transmit PDO on SYNC** is checked, the TPDO messages are sent on SYNC message. In the field **Transmission Type** the number of SYNC messages before the transmission of the PDO is defined;
- If the field **Send Transmit PDO on Change** is checked, the TPDO is transmitted when the data from Modbus TCP side change.

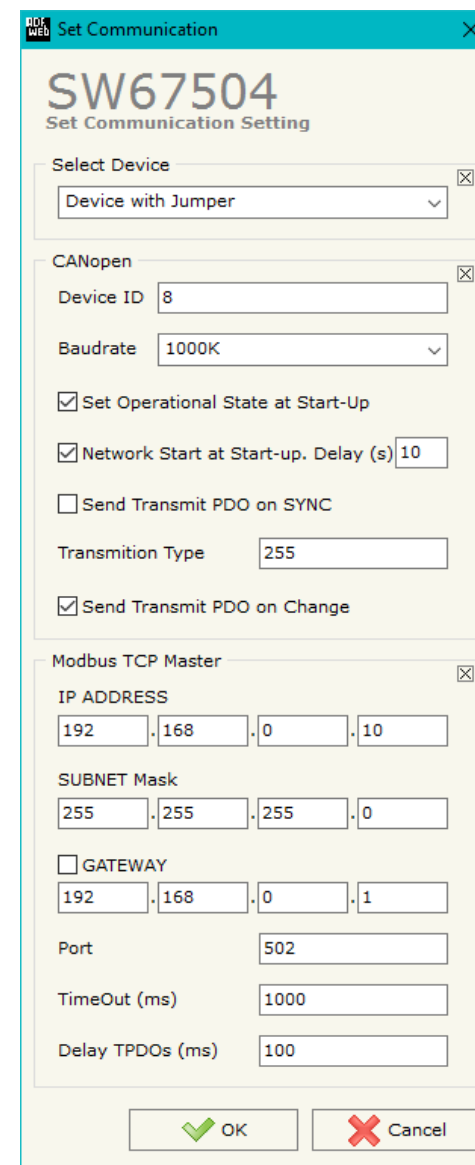
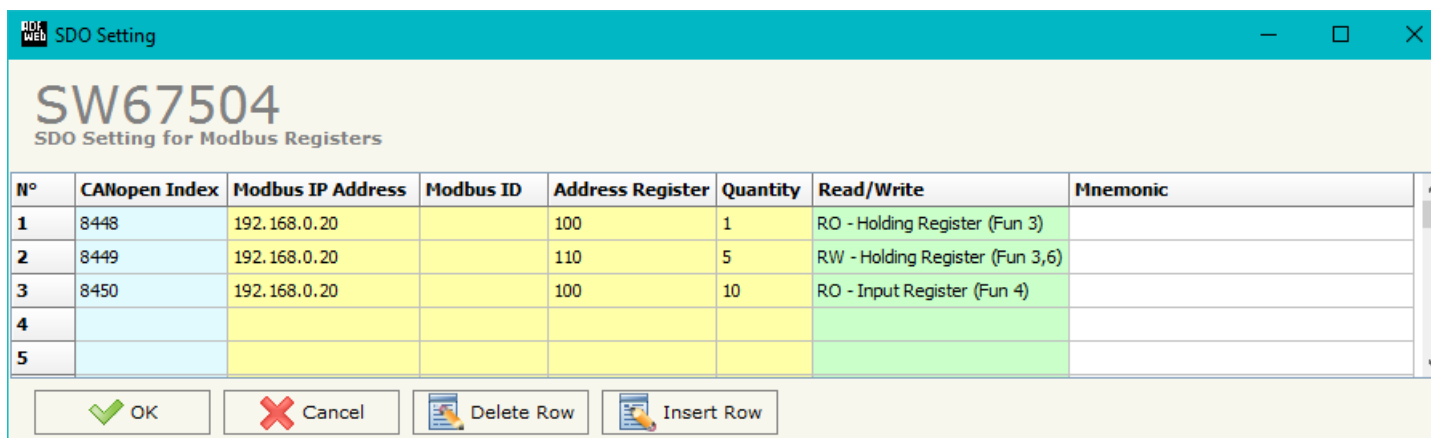

Figure 3: "Set Communication" window

The means for the fields for "Modbus TCP Master" are:

- In the field "**IP Address**" the IP address for the Modbus TCP side is defined;
- In the field "**SubNet Mask**" the SubNet Mask for the Modbus TCP side is defined;
- In the field "**Gateway**" the default gateway of the net is defined. This feature can be enabled or disabled pressing the Check Box field. This feature is used for going out of the net;
- In the field "**Port**" the number of the TCP port for the Modbus TCP communication is defined;
- In the field "**TimeOut (ms)**" the timeout for the Modbus TCP communication is defined;
- In the field "**Delay TPDOs (ms)**" the delay with which the data into the TPDOs is refreshed is defined.

SDO SETTING:

N°	CANopen Index	Modbus IP Address	Modbus ID	Address Register	Quantity	Read/Write	Mnemonic
1	8448	192.168.0.20		100	1	RO - Holding Register (Fun 3)	
2	8449	192.168.0.20		110	5	RW - Holding Register (Fun 3,6)	
3	8450	192.168.0.20		100	10	RO - Input Register (Fun 4)	
4							
5							

Figure 4: "SDO Setting for Modbus Registers" window

By pressing the "**SDO Setting**" button from the main window for SW67504 (Fig. 4) the window "SDO Setting for Modbus Registers" appears (Fig. 4):

- In the field "**CANopen Index**" the Index of the SDO Object is defined;
- In the field "**Modbus IP Address**" the IP Address of the Modbus device to poll is defined;
- In the field "**Modbus ID**" the ID of the Modbus device to poll is defined;
- In the field "**Address Register**" the address of the Modbus register to read/write is defined;
- In the field "**Quantity**" the number of consecutive Modbus register to read/write is defined;
- In the field "**Read/Write**" the type of SDO Object is defined (RO: ReadOnly or RW:ReadWrite);
- In the field "**Mnemonic**" a brief description is defined.

The Modbus TCP requests will be sent when a SDO request is received on CANopen. The CANopen Client needs to have a timeout higher than 500 ms. The reply time is the time for a Modbus query plus the Modbus response.

SDO SETTING STATUS (only for 'Hardware with Dip-Switch'):

N	CANopen Index	SubIndex	Modbus IP Address	Modbus ID	Address Status	Quantity	Read/Write	Mnemonic
1	8451	0	192.168.0.20	1	1	4	RW - Coil Status (Fun 1,5,15)	
2								
3								
4								
5								

Figure 5: "SDO Setting for Modbus Status" window

By pressing the "**SDO Setting Status**" button from the main window for SW67504 (Fig. 4) the window "SDO Setting for Modbus Status" appears (Fig. 5):

- In the field "**CANopen Index**" the Index of the SDO Object is defined;
- In the field "**SubIndex**" the SubIndex of the SDO Object is defined;
- In the field "**Modbus IP Address**" the IP Address of the Modbus device to poll is defined;
- In the field "**Modbus ID**" the ID of the Modbus device to poll is defined;
- In the field "**Address Status**" the address of the Modbus status to read/write is defined;
- In the field "**Quantity**" the number of consecutive Modbus status to read/write is defined;
- In the field "**Read/Write**" the type of SDO Object is defined (RO: ReadOnly or RW:ReadWrite);
- In the field "**Mnemonic**" a brief description is defined.

The Modbus TCP requests will be sent when a SDO request is received on CANopen. The CANopen Client needs to have a timeout higher than 500 ms. The reply time is the time for a Modbus query plus the Modbus response.

PDO SETTING:

The converter allows to use 4 Receive PDOs and 4 Transmit PDOs.

Sending a defined RPDO to the converter, the Modbus writing request will be sent to the defined Modbus TCP device.

The TPDO sent by the converter will contain the data read from the Modbus TCP devices.

By pressing the “**PDO Setting**” button from the main window for SW67504 (Fig. 4) the window “PDO Setting for Modbus Registers” appears (Fig. 6):

- In the field “**Index**” the SDO Objects where the PDO is linked is defined (not editable);
- In the field “**Description**” the description of the SDO Object is defined (not editable);
- In the field “**Modbus IP Address**” the IP address of the Modbus device to poll is defined;
- In the field “**Address Register**” the address of the Modbus register to read/write is defined;
- In the field “**Type**” the type of Modbus registers is defined (only for TPDOs);
- In the field “**Num Points**” the number of consecutive Modbus registers to read/write is defined;
- In the field “**Delta Send**” the difference between the last data read and the new data for which the TPDOs is sent is defined (only for Transmit PDO);
- If the field “**Swap**” is checked, the bytes of each word are swapped;
- In the field “**Mnemonic**” a brief description is defined.

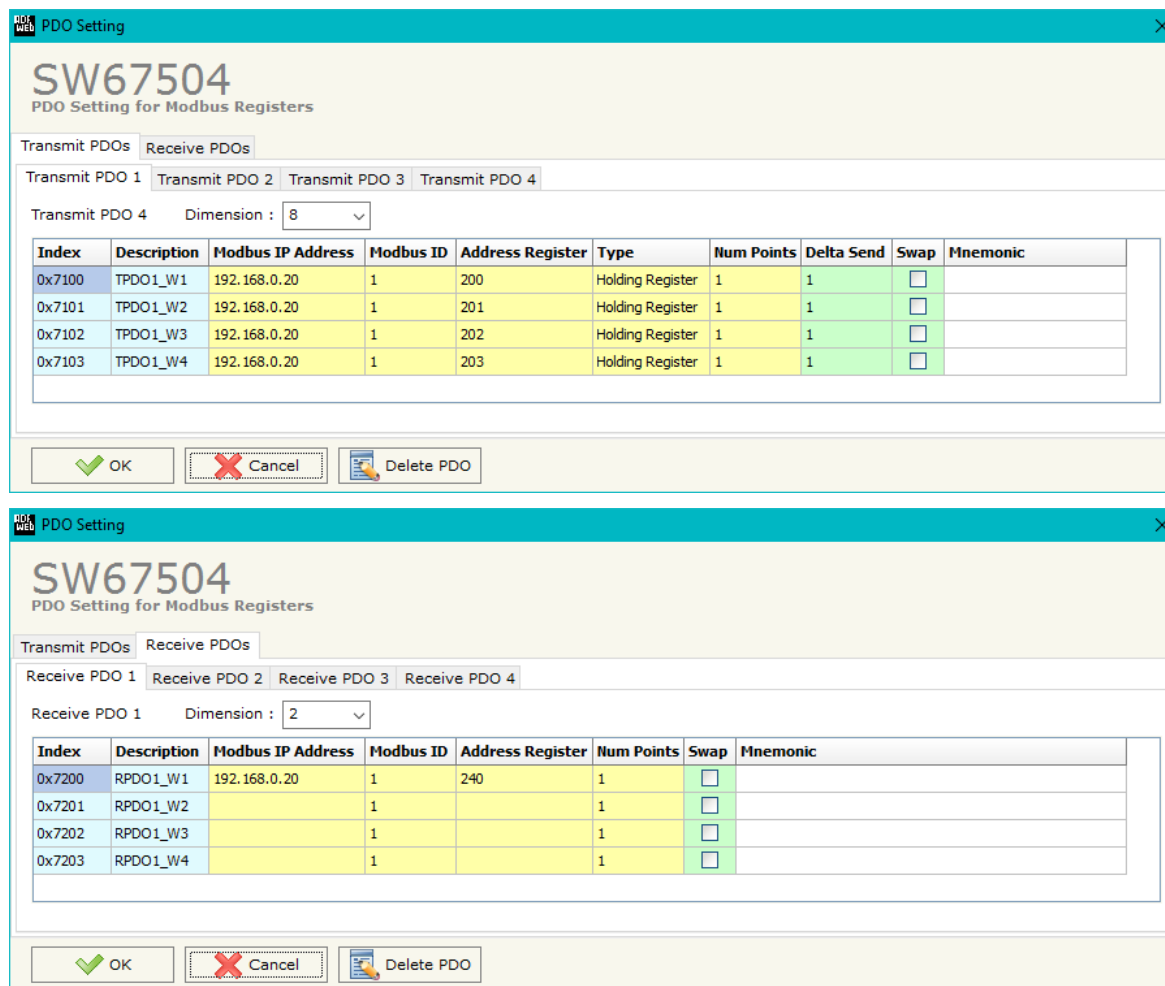

Figure 6: “PDO Setting for Modbus Registers” window

PDO SETTING STATUS (only for 'Hardware with Dip-Switch'):

The converter has 2 additional PDOs (one in reception and one is transmission) used to send/receive the status of the Modbus devices.

By pressing the "PDO Setting Status" button from the main window for SW67504 (Fig. 4) the window "PDO Setting for Modbus Status" appears (Fig. 7):

- In the field "Cob-ID for the Transmit/Receive PDO 5" the CON-Ids of the PDOs is defined;
- In the field "Modbus IP Address" the IP address of the Modbus device to poll is defined;
- In the field "Address Status" the address of the Modbus status to read/write is defined;
- In the field "Quantity" the number of consecutive Modbus status to read/write is defined;
- In the field "Status Type" the type of Modbus status is defined (only for TPDO);
- In the field "Mnemonic" a brief description is defined;
- In the field "MASK for Automatic Send of PDO" the mask for the status is defined. It allows to define for the changing of which status the PDO is sent is defined.

Example of mask:

Data read from Modbus	0001	0001	0011	1111	0001
Mask set	0011	0110	1111	1111	0011
Result	xx01	x00x	0011	1111	xx01

With this settings, the TPDO will be sent only when the not-masked bits will change.

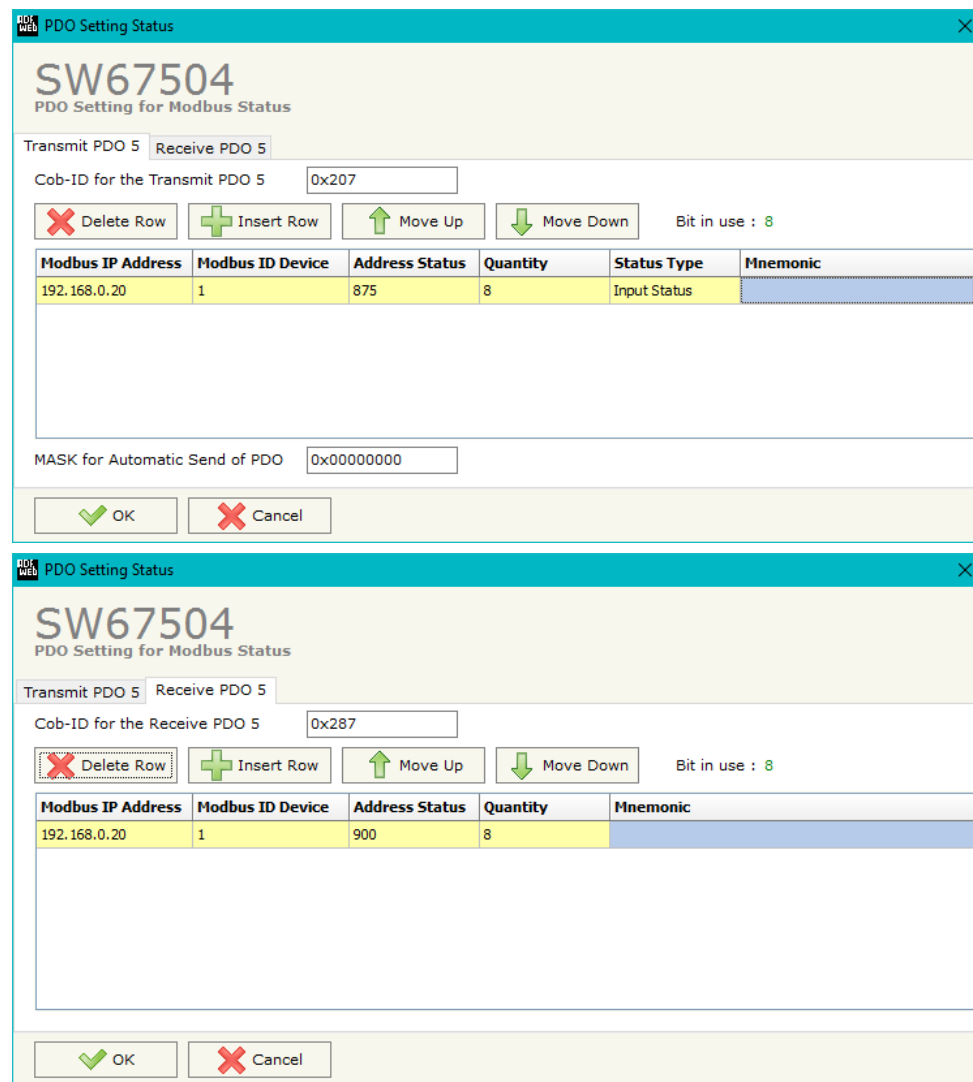

Figure 7: "PDO Setting for Modbus Status" window



EDS FILE:

By Pressing the “**EDS File**” button from the main window for SW67504 (Fig. 2) it is possible to generate the EDS file to be imported into the CANopen Client.

UPDATE DEVICE (for 'Hardware with Jumper'):

By pressing the "Update Device" button it is possible to load the created Configuration into the device, and also the Firmware if is necessary, using the RS232 port.

In order to load the parameters or update the firmware in the device, follow these instructions:

- Turn OFF the Device;
- Connect the RS232 cable from your PC to the Converter;
- Put the converter in Boot Mode;
- Select the "COM port" and press the "Connect" button;
- Turn ON the device;
- Check the "Device state" Led. It must blink quickly;
- Press the "Next" button;
- Select which operations you want to do.
- Press the "Execute update firmware" button to start the upload;
- When all the operations are "OK" turn OFF the device;
- Put the converter in Run Mode;
- Disconnect the RS232 cable;
- Turn ON the device.

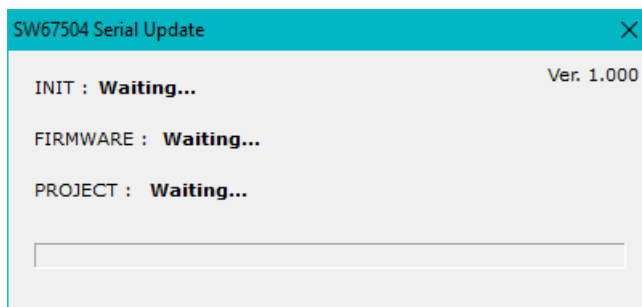
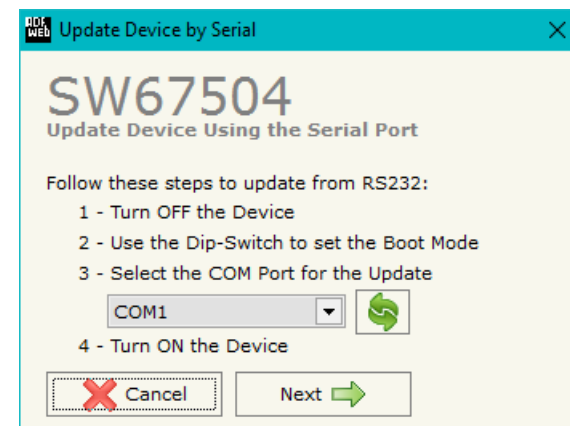

Figure 8: "Update via Serial" windows

UPDATE DEVICE (for 'Hardware with Dip-Switch'):

By pressing the **"Update Device"** button, it is possible to load the created Configuration into the device; and also the Firmware, if necessary.

If you don't know the actual IP address of the device you have to use this procedure:

- Turn OFF the Device;
- Put Dip2 of 'Dip-Switch A' in ON position;
- Turn ON the device
- Connect the Ethernet cable;
- Insert the IP **"192.168.2.205"**;
- Press the **"Ping"** button, "Device Found! must appear";
- Press the **"Next"** button;
- Select which operations you want to do;
- Press the **"Execute update firmware"** button to start the upload;
- When all the operations are "OK" turn OFF the Device;
- Put Dip2 of 'Dip-Switch A' in OFF position;
- Turn ON the device.

If you know the actual IP address of the device, you have to use this procedure:

- Turn ON the Device with the Ethernet cable inserted;
- Insert the actual IP of the Converter;
- Press the **"Ping"** button, must appear "Device Found!";
- Press the **"Next"** button;
- Select which operations you want to do;
- Press the **"Execute update firmware"** button to start the upload;
- When all the operations are "OK" the device automatically goes at Normal Mode.

At this point the configuration/firmware on the device is correctly updated.

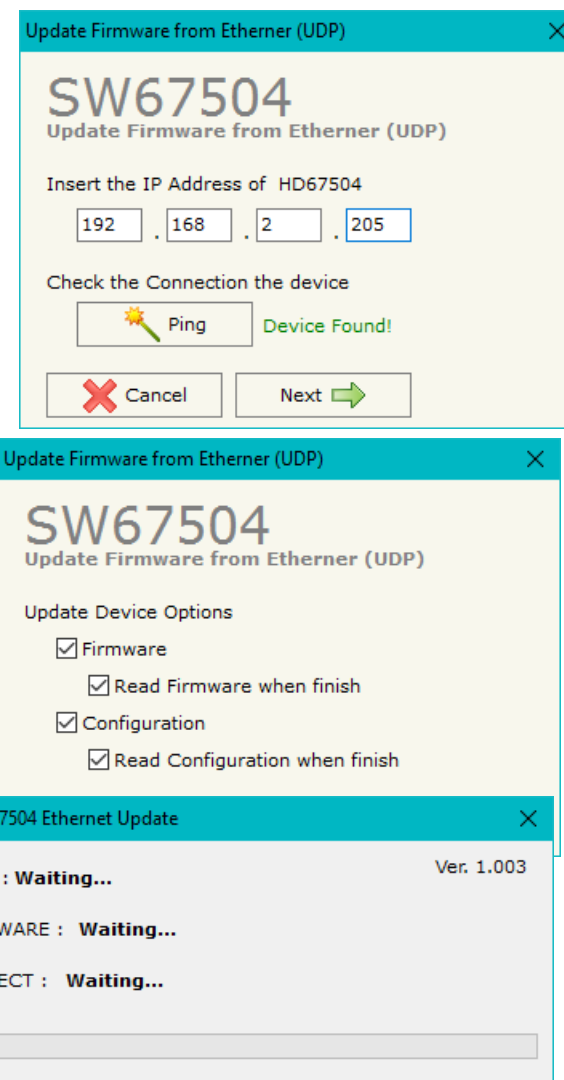

Figure 9: "Update via Ethernet" windows



Note:

When you install a new version of the software, if it is the first time it is better you do the update of the Firmware in the HD67504 device.



Note:

When you receive the device, for the first time, you also have to update the Firmware in the HD67504 device.



Warning:

If Fig. 10 appears when you try to do the Update try these points before seeking assistance:

- Check if the serial COM port selected is the correct one;
- Check if the serial cable is connected between the PC and the device;
- Try to repeat the operations for the updating;
- If you are using a USB↔RS232 converter try with a native COM port or change the converter;
- Try to repeat the operations for the updating;
- Try with another PC;
- Try to restart the PC;
- Check the LAN settings;
- If you are using the program inside a Virtual Machine, try to use in the main Operating System;
- If you are using Windows Seven, Vista, 8 and 10 make sure that you have the administrator privileges;
- In case you have to program more than one device, using the "UDP Update", you have to cancel the ARP table every time you connect a new device on Ethernet. For do this you have to launch the "Command Prompt" and write the command "arp -d". Pay attention that with Windows Vista, Seven, 8 you have to launch the "Command Prompt" with Administrator Rights;
- Pay attention at Firewall lock.

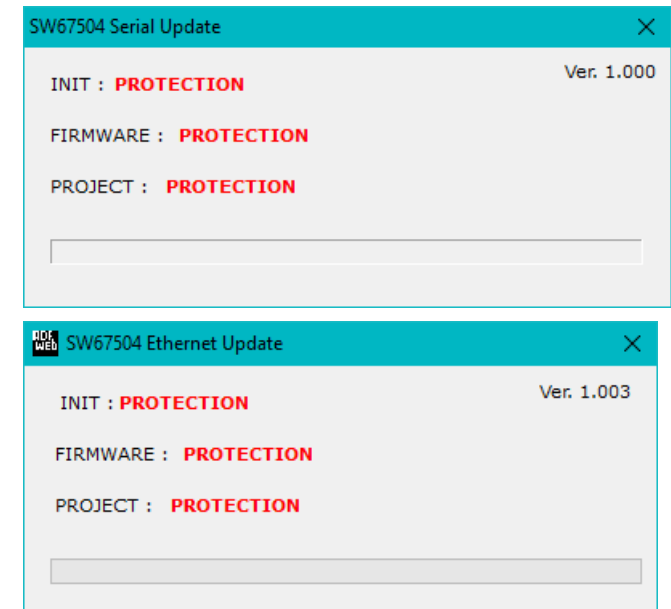
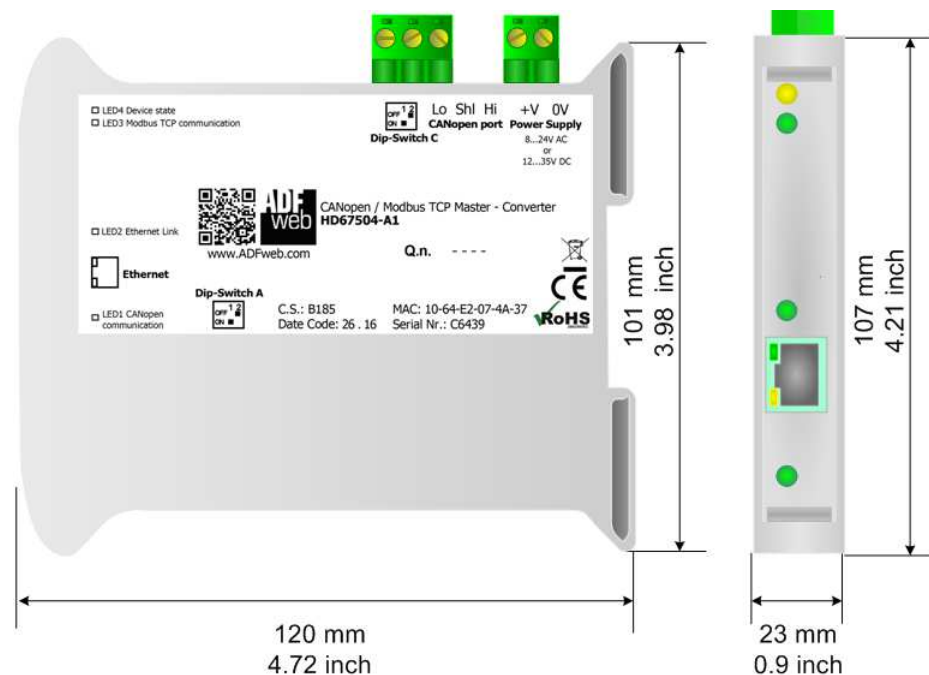

Figure 10: "Protection" window

In the case of HD67504 you have to use the software "SW67504": www.adfweb.com/download/filefold/SW67504.zip.

MECHANICAL DIMENSIONS:



Housing: PVC
Weight: 200g (Approx)

Figure 11a: Mechanical dimensions scheme for HD67504-A1

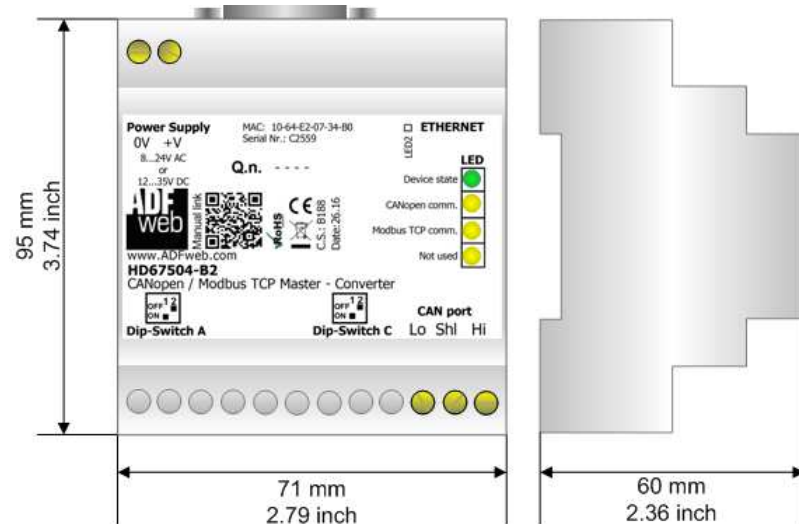

Housing: PVC
Weight: 200g (Approx)

Figure 11b: Mechanical dimensions scheme for HD67504-B2

ORDERING INFORMATIONS:

The ordering part number is formed by a valid combination of the following:

HD67504 - x x

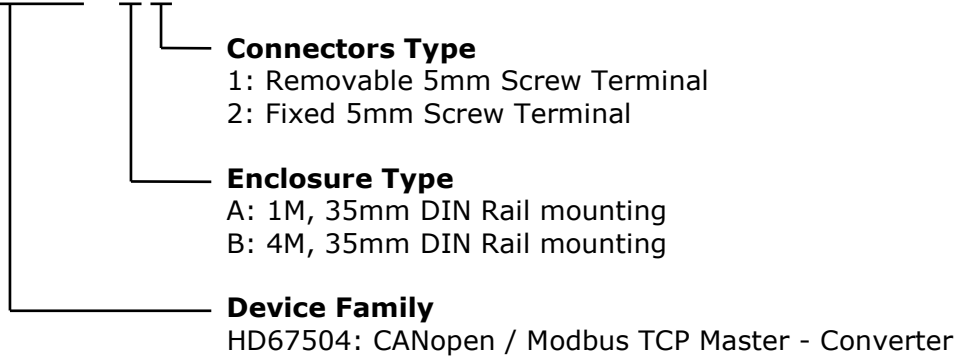

- Order Code: **HD67504-A1** - CANopen / Modbus TCP Master – Converter (Housing type: A, Terminal Blocks Connectors)
- Order Code: **HD67504-B2** - CANopen / Modbus TCP Master - Converter (Housing type: B, Terminal Blocks Connectors)

ACCESSORIES:

- Order Code: **AC34107** - Null Modem Cable Fem/Fem DSub 9 Pin 1,5 m
- Order Code: **AC34114** - Null Modem Cable Fem/Fem DSub 9 Pin 5 m
- Order Code: **AC34001** - Rail DIN - Power Supply 220/240V AC 50/60Hz – 12 V AC
- Order Code: **AC34002** - Rail DIN - Power Supply 110V AC 50/60Hz – 12 V AC

DISCLAIMER:

All technical content within this document can be modified without notice. The content of the document is a under continual renewal. For losses due to fire, earthquake, third party access or other accidents, or intentional or accidental abuse, misuse, or use under abnormal conditions repairs are charged to the user. ADFweb.com S.r.l. will not be liable for accidental loss of use or inability to use this product, such as loss of business income. ADFweb.com S.r.l. shall not be liable for consequences of improper use.

OTHER REGULATIONS AND STANDARDS:**WEEE INFORMATION**

Disposal of old electrical and electronic equipment (as in the European Union and other European countries with separate collection systems).

— This symbol on the product or on its packaging indicates that this product may not be treated as household rubbish. Instead, it should be taken to an applicable collection point for the recycling of electrical and electronic equipment. If the product is disposed correctly, you will help prevent potential negative environmental factors and impact of human health, which could otherwise be caused by inappropriate disposal. The recycling of materials will help to conserve natural resources. For more information about recycling this product, please contact your local city office, your household waste disposal service or the shop where you purchased the product.

RESTRICTION OF HAZARDOUS SUBSTANCES DIRECTIVE

The device respects the 2002/95/EC Directive on the restriction of the use of certain hazardous substances in electrical and electronic equipment (commonly referred to as Restriction of Hazardous Substances Directive or RoHS).

CE MARKING

The product conforms with the essential requirements of the applicable EC directives.

WARRANTIES AND TECHNICAL SUPPORT:

For fast and easy technical support for your ADFweb.com SRL products, consult our internet support at www.adfweb.com. Otherwise contact us at the address support@adfweb.com

RETURN POLICY:

If while using your product you have any problem and you wish to exchange or repair it, please do the following:

- Obtain a Product Return Number (PRN) from our internet support at www.adfweb.com. Together with the request, you need to provide detailed information about the problem.
- Send the product to the address provided with the PRN, having prepaid the shipping costs (shipment costs billed to us will not be accepted).

If the product is within the warranty of twelve months, it will be repaired or exchanged and returned within three weeks. If the product is no longer under warranty, you will receive a repair estimate.



ADFweb.com S.r.l.
Via Strada Nuova, 17
IT-31010 Mareno di Piave
TREVISO (Italy)
Phone +39.0438.30.91.31
Fax +39.0438.49.20.99
www.adfweb.com

