

# User Manual

Revision 2.100  
English

## Modbus Slave / Modbus TCP Master - Converter

(Order Code: HD67510-A1, HD67510-A1-422, HD67510-B2)

### Benefits and Main Features:

- Very easy to configure
- 32mm Rail DIN mount
- Wide supply input range
- Triple electrical isolation
- ⊕ Temperature range: -40°C/+85°C (-40°F/+185°F)
- ⊕
- ⊕
- ⊕
- ⊕

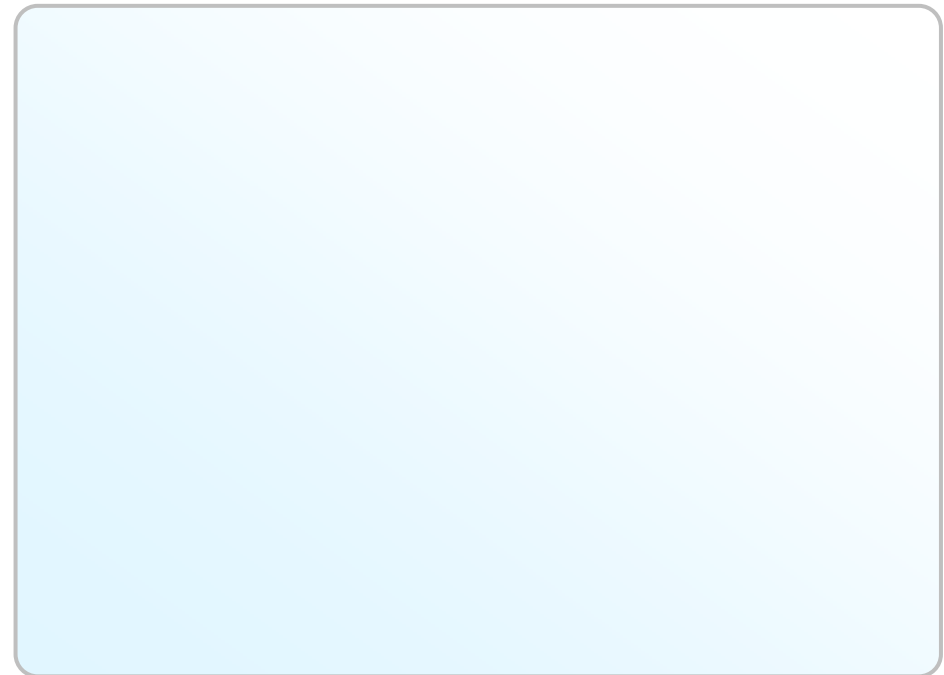

User Manual

**INDEX:**

	Page
INDEX	2
UPDATED DOCUMENTATION	2
REVISION LIST	2
WARNING	2
TRADEMARKS	2
SECURITY ALERT	3
EXAMPLES OF CONNECTION	4
CONNECTION SCHEME	5
CHARACTERISTICS	8
CONFIGURATION	8
POWER SUPPLY	9
FUNCTION MODES	10
LEDS	11
ETHERNET	12
RS232	12
RS485	13
RS422	14
USE OF COMPOSITOR SW67510	15
NEW CONFIGURATION / OPEN CONFIGURATION	16
SOFTWARE OPTIONS	17
SET COMMUNICATION	18
UPDATE VIA SERIAL	26
UPDATE VIA UDP	27
MECHANICAL DIMENSIONS	29
ORDERING INFORMATIONS	31
ACCESSORIES	31
DISCLAIMER	32
OTHER REGULATIONS AND STANDARDS	32
WARRANTIES AND TECHNICAL SUPPORT	33
RETURN POLICY	33

**UPDATED DOCUMENTATION:**

Dear customer, we thank you for your attention and we remind you that you need to check that the following document is:

- Updated
- Related to the product you own

To obtain the most recently updated document, note the “document code” that appears at the top right-hand corner of each page of this document.

With this “Document Code” go to web page [www.adfweb.com/download/](http://www.adfweb.com/download/) and search for the corresponding code on the page. Click on the proper “Document Code” and download the updates.

**REVISION LIST:**

Revision	Date	Author	Chapter	Description
1.012	24/01/2013	Nt	All	Added new chapters
2.000	12/02/2014	Fl	All	New hardware version
2.001	12/09/2014	Ff	All	Add new functions
2.100	10/07/2019	Ff	All	Revision

**WARNING:**

ADFweb.com reserves the right to change information in this manual about our product without warning. ADFweb.com is not responsible for any error this manual may contain.

**TRADEMARKS:**

All trademarks mentioned in this document belong to their respective owners.

**SECURITY ALERT:****GENERAL INFORMATION**

To ensure safe operation, the device must be operated according to the instructions in the manual. When using the device, legal and safety regulation are required for each individual application. The same applies also when using accessories.

**INTENDED USE**

Machines and systems must be designed so the faulty conditions do not lead to a dangerous situation for the operator (i.e. independent limit switches, mechanical interlocks, etc.).

**QUALIFIED PERSONNEL**

The device can be used only by qualified personnel, strictly in accordance with the specifications. Qualified personnel are persons who are familiar with the installation, assembly, commissioning and operation of this equipment and who have appropriate qualifications for their job.

**RESIDUAL RISKS**

The device is state-of-the-art and is safe. The instruments can represent a potential hazard if they are inappropriately installed and operated by untrained personnel. These instructions refer to residual risks with the following symbol:



This symbol indicates that non-observance of the safety instructions is a danger for people that could lead to serious injury or death and / or the possibility of damage.

**CE CONFORMITY**

The declaration is made by our company. You can send an email to [or](#) give us a call if you need it.

**EXAMPLES OF CONNECTION:**

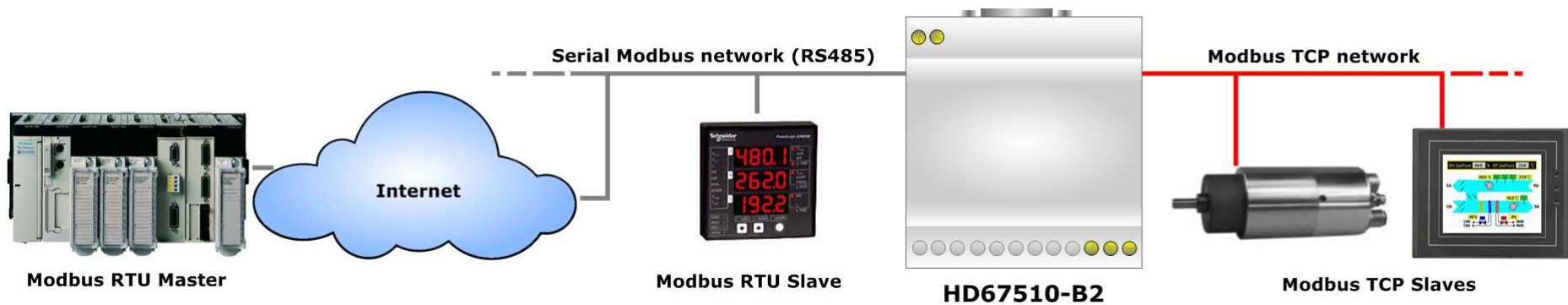
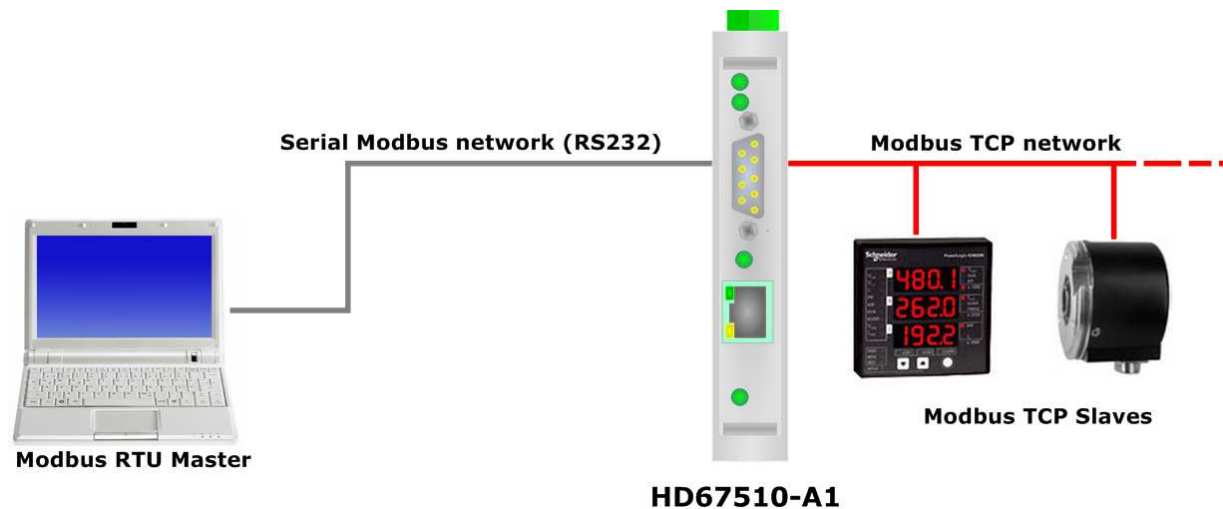



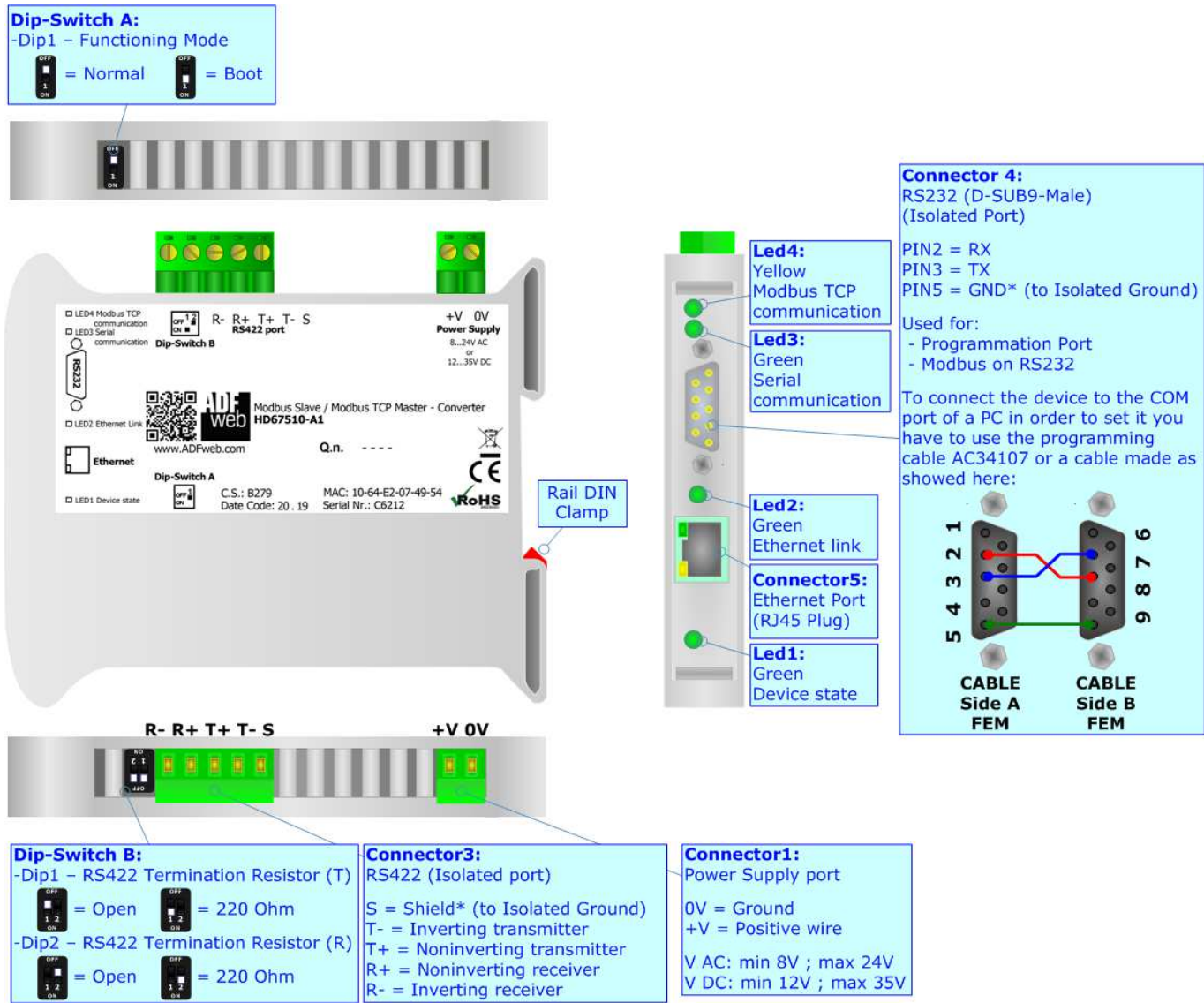

Figure 1b: Connection scheme for HD67510-A1-422



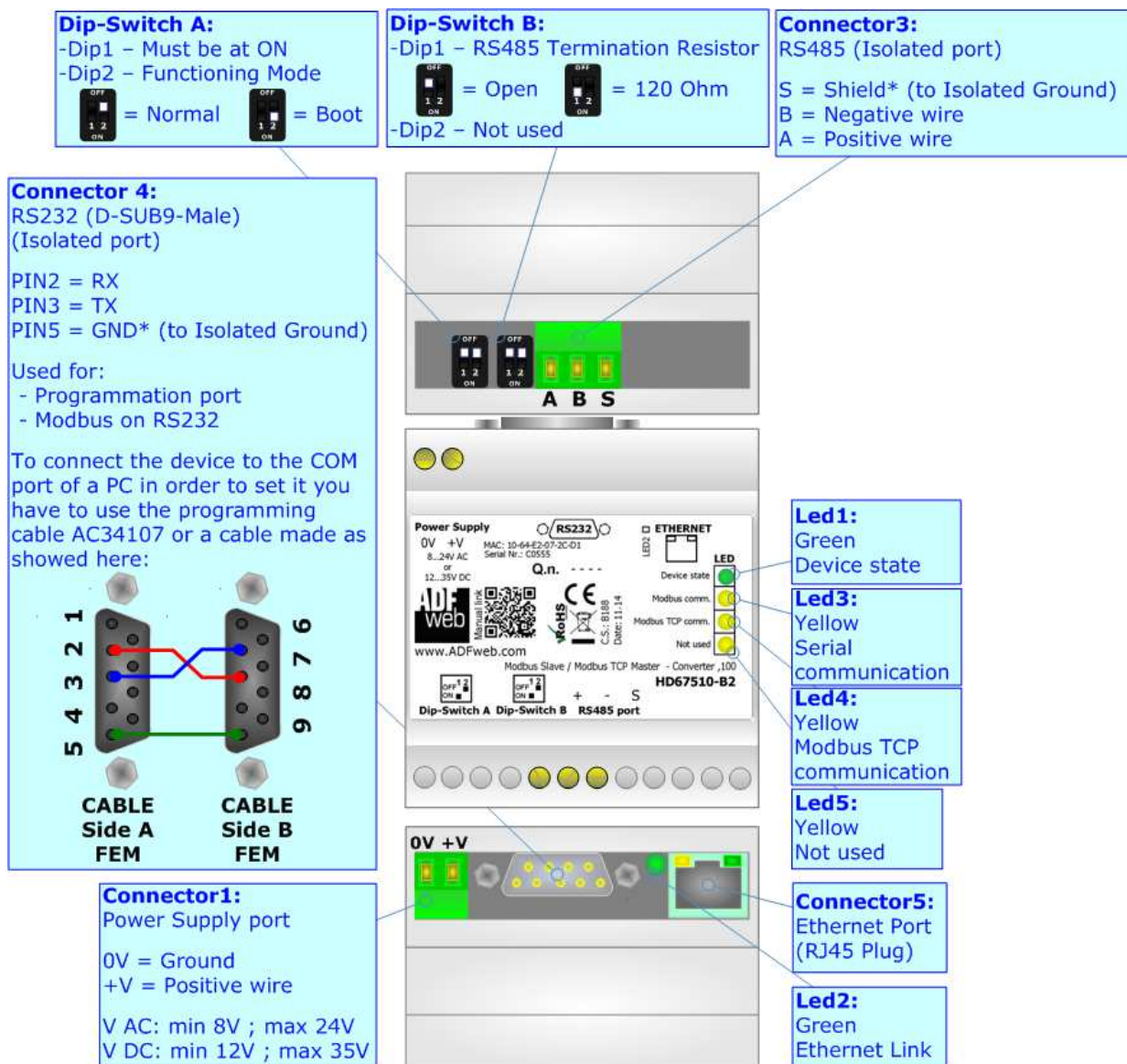

Figure 1c: Connection scheme for HD67510-B2

**CHARACTERISTICS:**

The HD67510-A1 and HD67510-B2 are a Modbus Slave / Modbus TCP Master – Converter.

It allows for the following characteristics:

- Triple isolation between Serial - Power Supply, Serial - Ethernet, Power Supply - Ethernet.
- Ethernet 10Base-T / 100Base-T, autosensing for Modbus TCP ;
- Mountable on 35mm Rail DIN;
- Wide power supply input range: 8...24V AC or 12...35V DC;
- Wide temperature range: -40°C / 85°C [-40°F / +185°F].

**CONFIGURATION:**

You need Compositor SW67510 software on your PC in order to perform the following:

- Define the parameters of Modbus TCP line;
- Define the parameters of Serial Modbus line;
- Update the device.



**POWER SUPPLY:**

The devices can be powered at 8...24V AC and 12...35V DC. For more details see the two tables below.

VAC		VDC	
Vmin	Vmax	Vmin	Vmax
8V	24V	12V	35V

Consumption at 24V DC:

Device	Consumption [W/VA]
HD67510-A1-xxx	3.5
HD67510-B2	3.5

**Caution: Not reverse the polarity power**

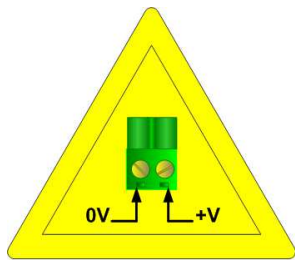

HD67510-A1  
HD67510-A1-422

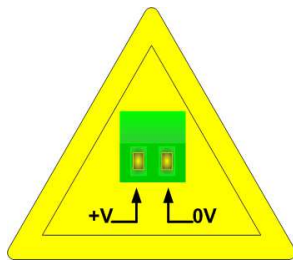

HD67510-B2

**Connector1:**  
 Power Supply port  
 0V = Ground  
 +V = Positive wire  
 V AC: min 8V ; max 24V  
 V DC: min 12V ; max 35V

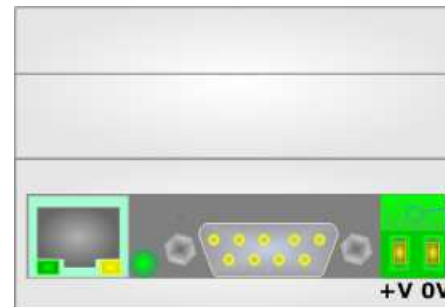
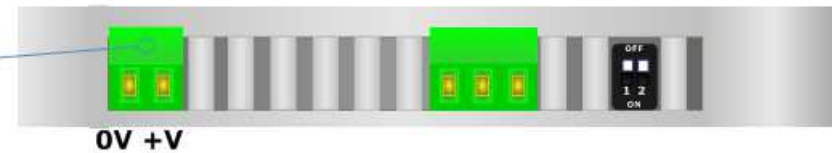

**Connector1:**  
 Power Supply port  
 0V = Ground  
 +V = Positive wire  
 V AC: min 8V ; max 24V  
 V DC: min 12V ; max 35V

**FUNCTION MODES:**

The device has got two function modes depending on the position of the 'Dip-Switch A'.

HD67510-A1-xxx version:

- With 'Dip1 of Dip-Switch A' at "OFF" position, is used for the normal working of the device.
- With 'Dip1 of Dip-Switch A' at "ON" position, is used for uploading the Project and/or Firmware.

HD67510-B2 version:

- The first, with 'Dip2 of Dip-Switch A' at "OFF" position, is used for the normal working of the device.
- The second, with 'Dip2 of Dip-Switch A' at "ON" position, is used for uploading the Project and/or Firmware.

For the operations to follow for the updating, see 'UPDATE DEVICE' section.

According to the functioning mode, the LEDs will have specific functions, see 'LEDS' section.

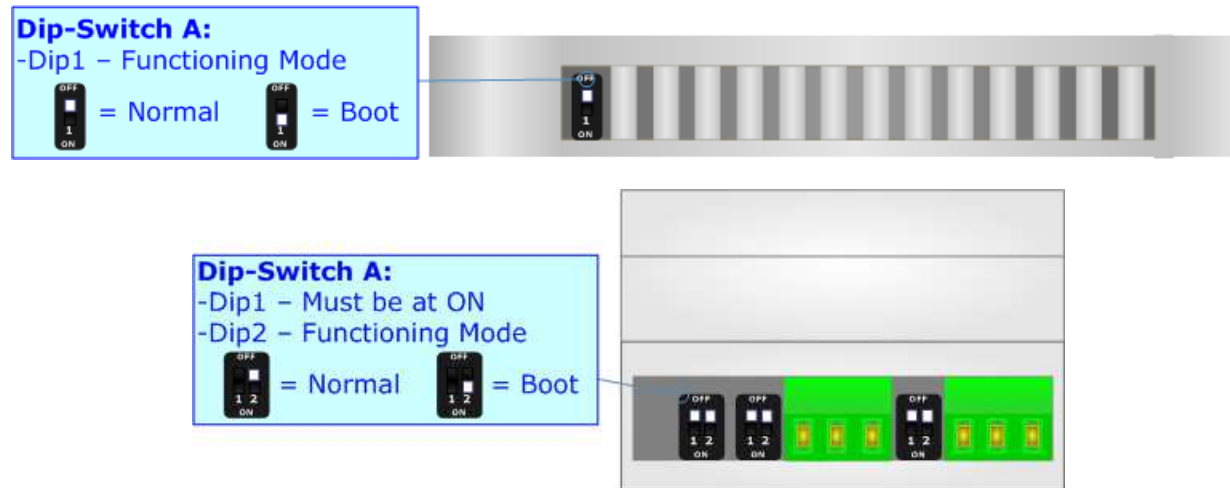

**LEDS:**

The devices has got four (five for HD67510-B2) LEDs that are used to give information of the functioning status. The various meanings of the LEDs are described in the table below.

LED	Normal Mode	Boot Mode
1: Device state	Blinks slowly (~1Hz)	<b>Blinks quickly:</b> Boot state <b>Blinks very slowly (~0.5Hz):</b> update in progress
2: Ethernet Link	<b>ON:</b> Ethernet cable connected <b>OFF:</b> Ethernet cable disconnected	<b>ON:</b> Ethernet cable connected <b>OFF:</b> Ethernet cable disconnected
3: Serial communication	Blinks when are received Modbus response frames (RS232/RS485)	<b>Blinks quickly:</b> Boot state <b>Blinks very slowly (~0.5Hz):</b> update in progress
4: Modbus TCP communication	Blinks when are received Modbus TCP request frames	<b>Blinks quickly:</b> Boot state <b>Blinks very slowly (~0.5Hz):</b> update in progress
5: Not used (present only on HD67510-B2)	OFF	<b>Blinks quickly:</b> Boot state <b>Blinks very slowly (~0.5Hz):</b> update in progress

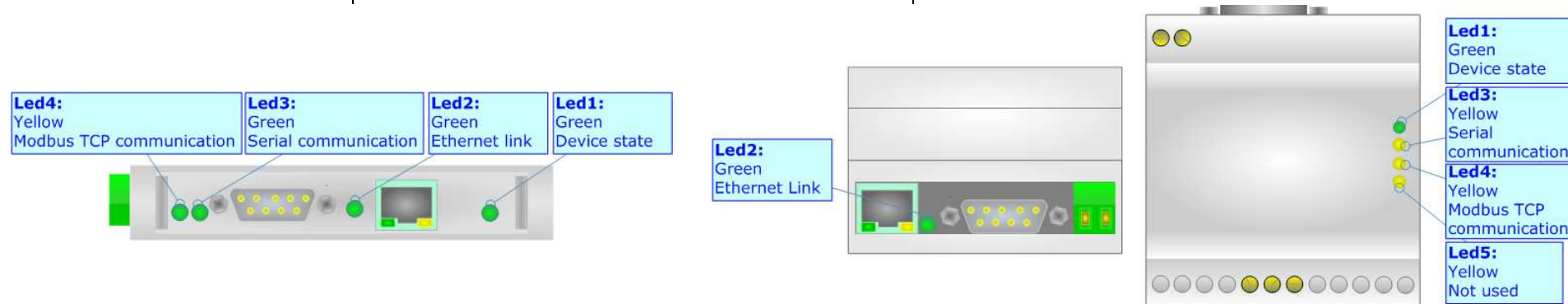

**ETHERNET:**

The Ethernet connection must be made using Connector5 of HD67510-A1/HD67510-B2 with at least a Category 5E cable. The maximum length of the cable should not exceed 100m. The cable has to conform to the T568 norms relative to connections in cat.5 up to 100 Mbps. To connect the device to a Hub/Switch the use of a straight cable is recommended. To connect the device to a PC/PLC/other the use of a cross cable is recommended.

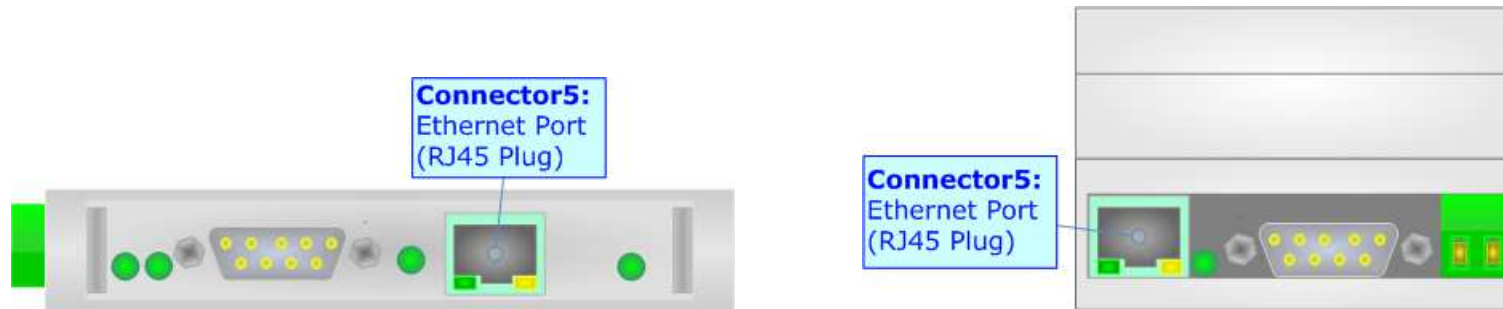

**RS232:**

The connection from RS232 socket to a serial port (example one from a personal computer) must be made with a Null Modem cable (a serial cable where the pins 2 and 3 are crossed). It is recommended that the RS232 cable not exceed 15 meters. The device is provided with a D-sub connector type DE-9 Male (also called DB-9). The cable must use a DE-9 Female connector. The serial port is used for programming the device and for Modbus communication.

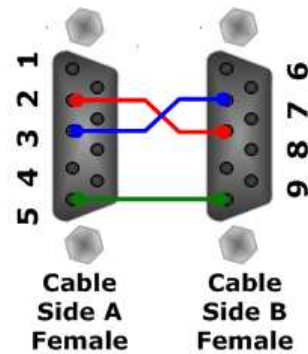

**RS485:**

To terminate the RS485 line with a 120Ω resistor, it is necessary to put dip 1 ON, like in figure.

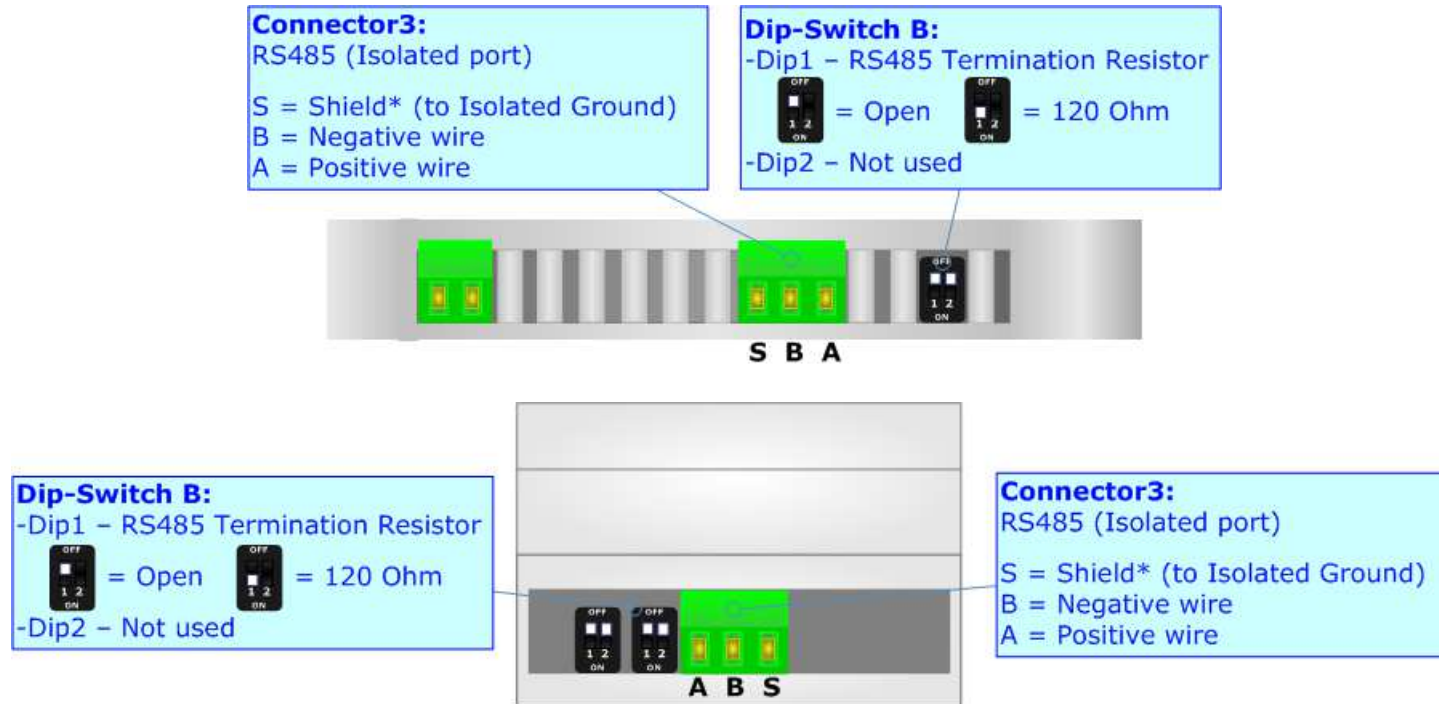

The maximum length of the cable should be 1200m (4000 feet).

Here some codes of cables:

- Belden: p/n 8132 - 2x 28AWG stranded twisted pairs conductor + foil shield + braid shield;
- Belden p/n 82842 - 2x 24AWG stranded twisted pairs conductor + foil shield + braid shield;
- Tasker: p/n C521 - 1x 24AWG twisted pair conductor + foil shield + braid shield;
- Tasker: p/n C522 - 2x 24AWG twisted pairs conductor + foil shield + braid shield.

**RS422:**

For terminate the RS422 line with a 120Ω resistor it is necessary to put ON dip 1 for T line and/or put ON dip 2 for R line, like in figure.

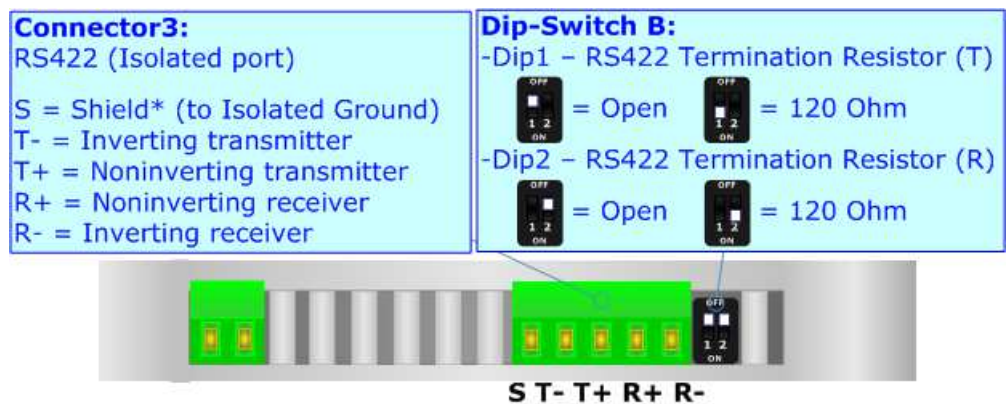

The maximum length of the cable should be 1200m (4000 feet).



### USE OF COMPOSITOR SW67510:

To configure the Converter, use the available software that runs with Windows called SW67510. It is downloadable on the site [www.adfweb.com](http://www.adfweb.com) and its operation is described in this document. *(This manual is referenced to the last version of the software present on our web site)*. The software works with MSWindows (XP, Vista, Seven, 8, 10; 32/64bit).

When launching the SW67510, the window on the right appears (Fig. 2).



**Note:**

It is necessary to have installed .Net Framework 4.

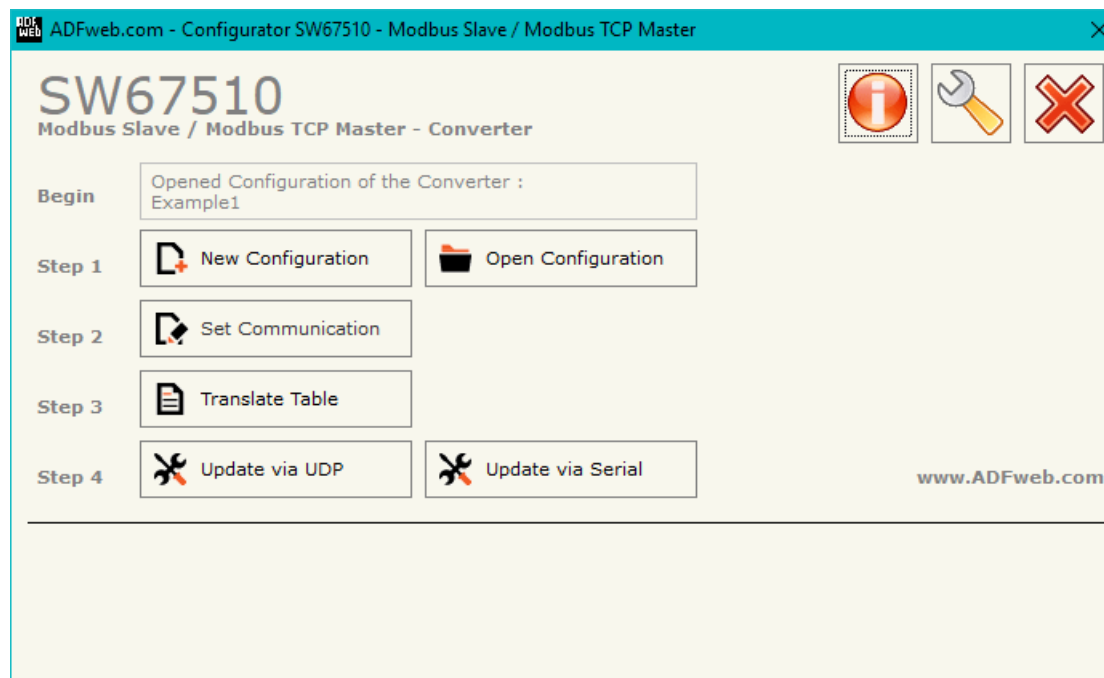
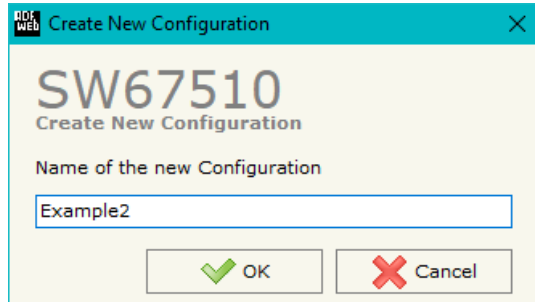

Figure 2: Main window for SW67510

**NEW CONFIGURATION / OPEN CONFIGURATION:**

The “**New Configuration**” button creates the folder which contains the entire device’s configuration.



A device’s configuration can also be imported or exported:

- To clone the configurations of a Programmable “Modbus Slave / Modbus TCP Master - Converter” in order to configure another device in the same manner, it is necessary to maintain the folder and all its contents;
- To clone a project in order to obtain a different version of the project, it is sufficient to duplicate the project folder with another name and open the new folder with the button “**Open Configuration**”.

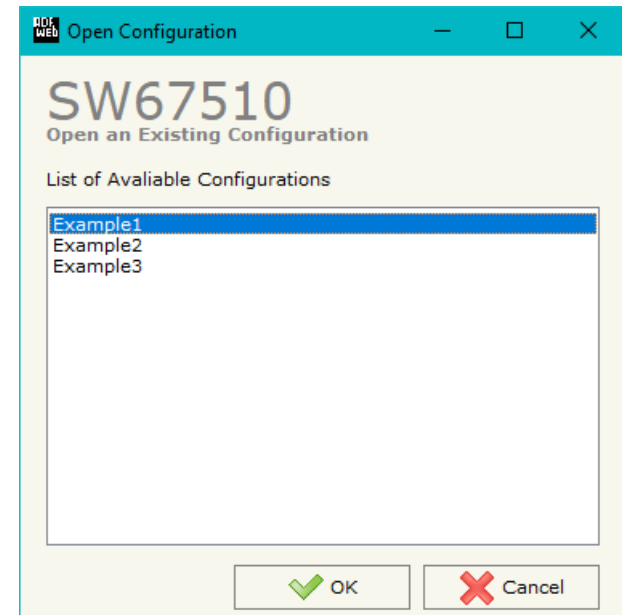

## SOFTWARE OPTIONS:

By pressing the “**Settings**” () button there is the possibility to change the language of the software and check the updatings for the compositor.

In the section “Language” it is possible to change the language of the software.

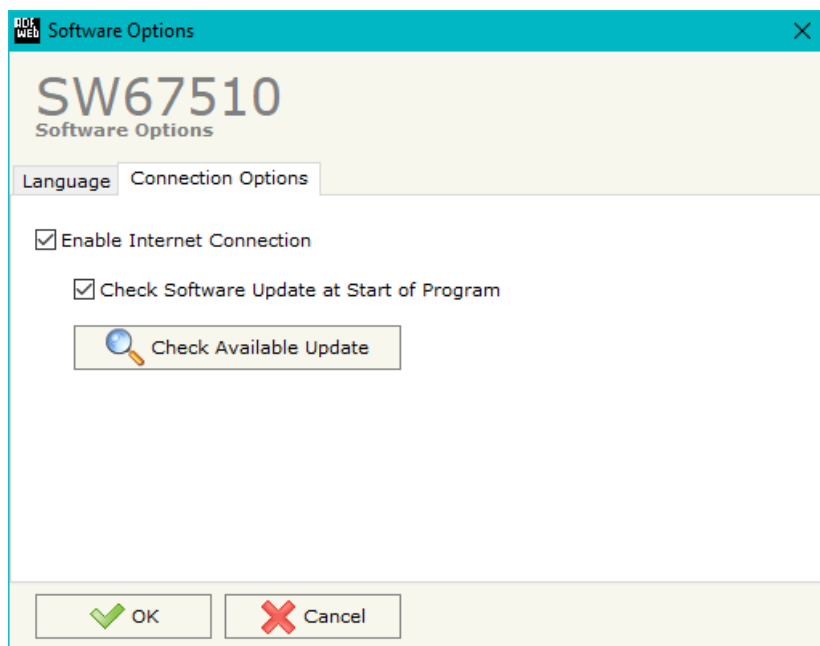

In the section “Connection Options”, it is possible to check if there are some updatings of the software compositor in ADFweb.com website. Checking the option “**Check Software Update at Start of Program**”, the SW67510 check automatically if there are updatings when it is launched.

**SET COMMUNICATION:**

By Pressing the "**Set Communication**" button from the main window for SW67510 (Fig. 2) the window "Set Communication" appears (Fig. 3).

The window is divided in different sections in order to define the different parameters of the converter:

- Operation Mode
- Modbus Slave
- Modbus TCP Master

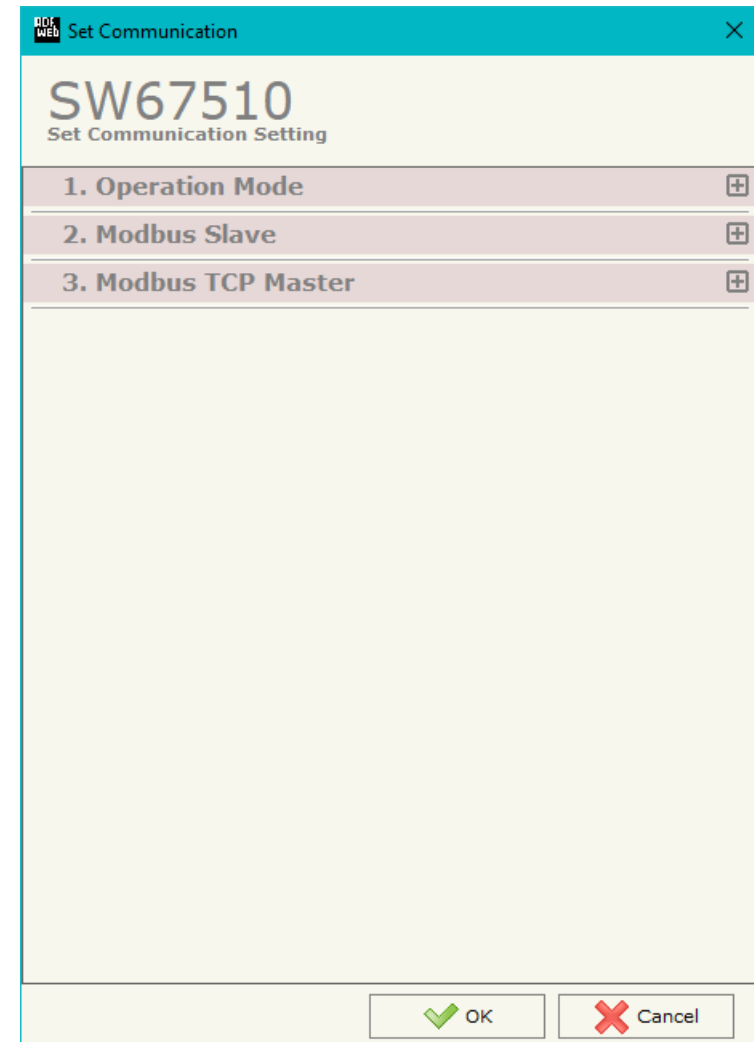

Figure 3a: "Set Communication" window

**OPERATION MODE:**

This section is used to define the working mode of MQTT side of the converter. It is possible to define:

- **Normal Mode (with Translate Table):** the converter can be seen like a single serial Modbus slave. The address of Modbus is assigned in the "Set Communication" section.
- **Routing Slave Address:** the converter can be seen like more than one serial Modbus slave. Each serial Modbus slave is a row of the table and it is possible to assign to which TCP device is linked.
- **Work with Fix IP Address:** the converter can be seen like a single serial Modbus slave. The address of Modbus is assigned in the "Set Communication" section. It is not necessary to compile the Translate Table: every request that arrives on serial is transferred on TCP (using TCP format of frame) to the slave with the IP address defined in the "Set Communication" section.

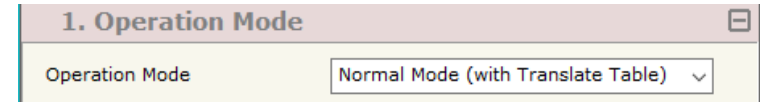

Figure 3b: "Set Communication → Operation Mode" window

**MODBUS SLAVE:**

This section is used to define the main parameters of Modbus line. The means of the fields are:

- In the field "Serial" the serial lien to use for Modbus communication is defined;
- In the field "Baudrate" the baudrate for the serial line is defined;
- In the field "Parity" the parity of the serial line is defined;
- In the field "Stop Bits" the number of Stop Bits is defined;
- In the field "ID Device" the address of serial Modbus device is defined. This field can be compiled only if the selected "Operation Mode" is "Normal Mode (with Translate Table)" or "Work with Fix IP Address";
- If the option "Enable Broadcast message with ID Zero" is checked, the converter will accept broadcast requests addressed to the Modbus ID 0 (only if "Routing Slave Address" mode is set);
- If the option "No Modbus Exception on TCP TimeOut" is checked, the converter does not send any exception code in case of missing response from Modbus TCP side. Otherwise, it sends the exception code 0x36.

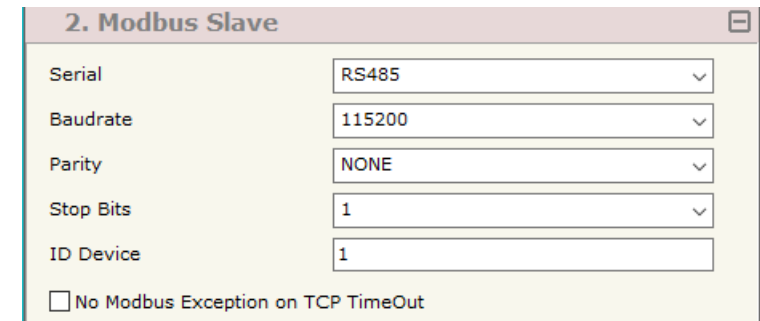
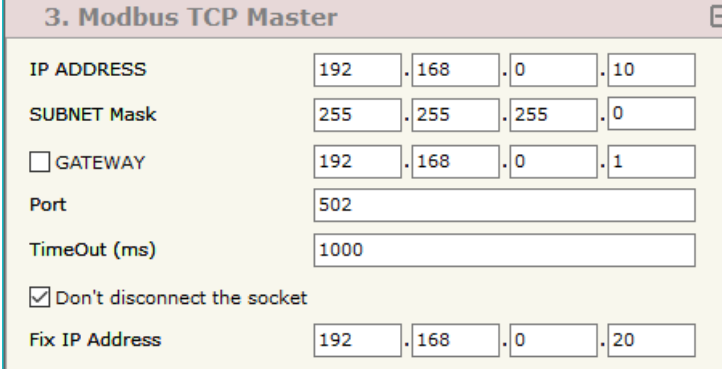

Figure 3c: "Set Communication → Modbus Slave" window

**MODBUS TCP MASTER:**

This section is used to define the main parameters of Modbus line. The means of the fields are:

- In the field "**IP Address**" the IP address of the converter is defined;
- In the field "**SubNet Mask**" the Subnet Mask of the converter is defined;
- In the field "**Gateway**" the default gateway of the net is defined. This feature can be enabled or disabled pressing the Check Box field. This feature is used for going out of the net;
- In the field "**Port**" the TCP port for Modbus TCP communication of the converter is defined;
- If the option "**Don't disconnect the socket**" is checked, the converter will hold the TCP connection opened. Otherwise. It will close it after every request/response.
- In the field "**Fix IP Address**" the IP Address of the Modbus TCP slave is defined (only if "Work with Fix IP Address" mode is set).



3. Modbus TCP Master				
IP ADDRESS	192	.168	.0	.10
SUBNET Mask	255	.255	.255	.0
<input type="checkbox"/> GATEWAY	192	.168	.0	.1
Port	502			
TimeOut (ms)	1000			
<input checked="" type="checkbox"/> Don't disconnect the socket				
Fix IP Address	192	.168	.0	.20

Figure 3d: "Set Communication → Modbus TCP Master" window



**NORMAL MODE (WITH TRANSLATE TABLE):**

Using this function, the converter can be seen like a single serial Modbus slave. The address of Modbus is assigned in the "Set Communication" section.

By pressing the "Translate Table" button from the main window for SW67510 (Fig. 2), the window "Set Translate Table" appears (Fig. 4).

The data of the columns have the following meanings:

- In the field "Data Type" the type of Modbus data is defined;
- In the field "Address" the address of the Modbus register to which address the requests on RTU side is defined;
- In the field "IP Address TCP" the IP address of the Modbus TCP slave to which the converter will address the request is defined;
- In the field "Address TCP" the address of the Modbus register to which the converter will address the TCP request is defined;
- In the field "NPoint" the number of consecutive registers starting from the one set is defined;
- In the field "Mnemonic" a brief description is defined.

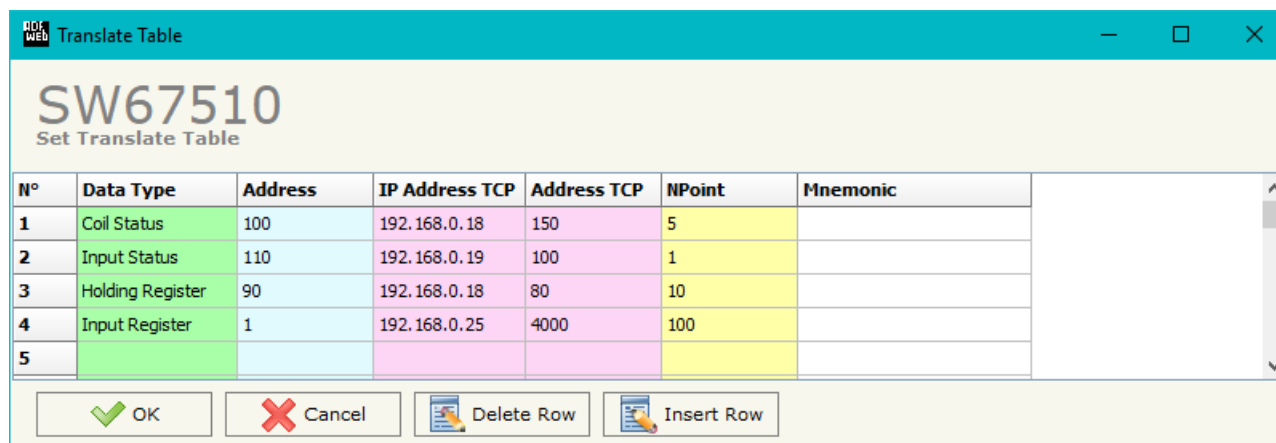

Figure 4: "Set Translate Table" window

**EXAMPLE 1:**

Taking the first row of Figure 4:

**Step 1:** A serial Modbus master do the request to the Converter to read the "Coil Status" address 100 for 5 consecutive points;

**Step 2:** The Converter sends to the TCP Slave 192.168.0.18 the read request of "Coil Status" address 150 for 5 consecutive points;

**Step 3:** The slave TCP replies to the Converter with the data;

**Step 4:** The Converter sends back the data on serial.

**EXAMPLE 2:**

Taking the second row of Figure 4:

**Step 1:** A serial Modbus master do the request to the Converter to read the "Input Status" address 110;

**Step 2:** The Converter sends to the TCP Slave 192.168.0.19 the read request of "Input Status" address 100;

**Step 3:** The slave TCP replies to the Converter with the data;

**Step 4:** The Converter sends back the data on serial.

**EXAMPLE 3:**

Taking the third row of Figure 4:

**Step 1:** A serial Modbus master do the request to the Converter to read the "Holding Register" address 91 for 6 consecutive points;

**Step 2:** The Converter sends to the TCP Slave 192.168.0.18 the read request of "Holding Register" address 81 for 6 consecutive points;

**Step 3:** The slave TCP replies to the Converter with the data;

**Step 4:** The Converter sends back the data on serial.

**Note:**

If the TCP slave responds with an exception, that exception code will be transmitted to the serial master. If the TCP slave does not respond within the estimated time defined by the Timeout parameter, an exception response will be given: error code \$36.

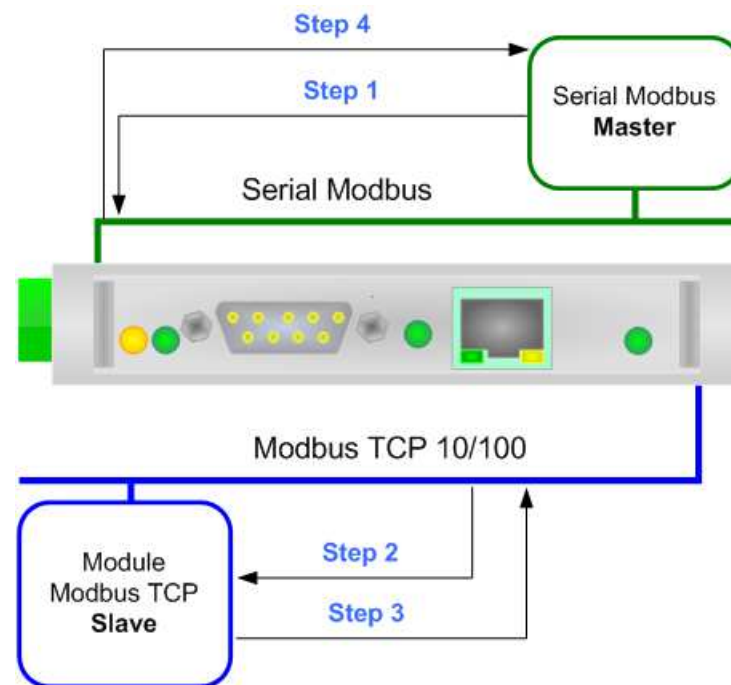

Figure 5: Chart of Request data from serial Modbus

**ROUTING SLAVE ADDRESS:**

Using this function, the converter can be seen like more than one serial Modbus slave. Each serial Modbus slave is a row of the table and it is possible to define to which TCP device is linked.

By pressing the “**Translate Table**” button from the main window for SW67510 (Fig. 2) the window “Set Translate Table” appears (Fig. 6).

The data of the columns have the following meanings:

- In the field “**Slave ID**” the ID of the virtual Modbus slave device created by the converter is defined;
- In the field “**IP Address TCP**” the IP address of the Modbus TCP slave device to which address the TCP requests is defined;
- In the field “**Slave ID TCP**” the station ID of the Modbus TCP slave device to which address the TCP requests is defined;
- If the field “**Reserved Socket**” is checked, the converter will reserve a socket for the specific Modbus TCP slave. This socket will be closed only after the number of consecutive errors defined in the “**Errors Sock**” column. It is possible to reserve up to 3 sockets for 3 different Modbus TCP slaves (function available only for Hardware Version with Dip-Switches);
- If the option “**UDP**” is checked, Modbus over UDP communication is enabled;
- If the option “**Broadcast**” is checked, the broadcast requests for that slave are accepted;
- In the field “**Mnemonic**” a brief description is defined.

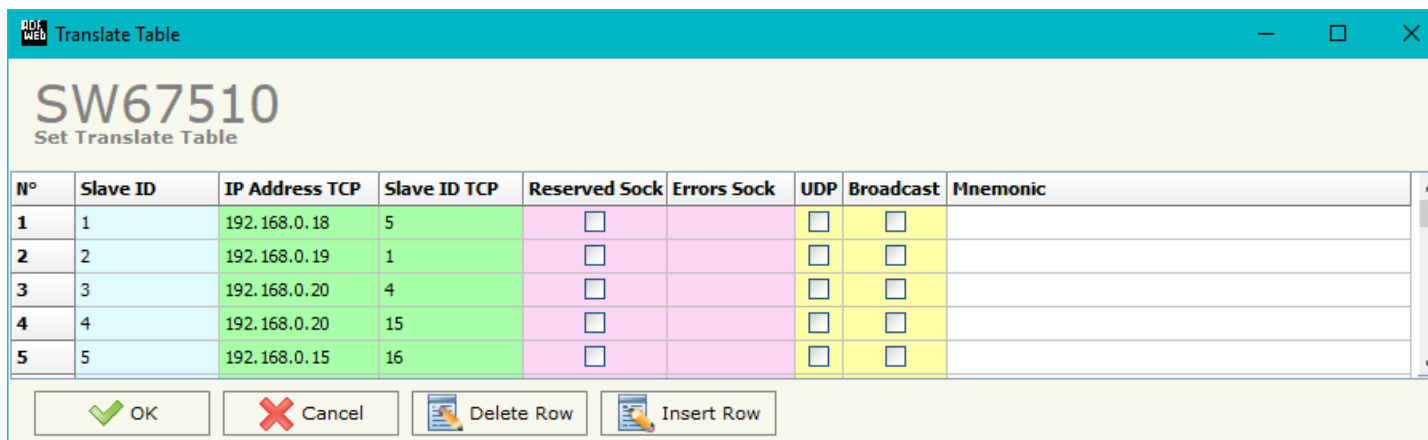

Figure 6: “Set Translate Table” window

**EXAMPLE 1:**

Taking the first row of Figure 6:

**Step 1:** A serial Modbus master do the request to the Converter to read/write a register from the serial slave Modbus ID 1;

**Step 2:** The Converter sends to the TCP slave 192.168.0.18 the read/write request using the TCP slave ID 5;

**Step 3:** The slave TCP replies to the Converter with the data;

**Step 4:** The Converter sends back the data on serial.

**EXAMPLE 2:**

Taking the second row of Figure 4:

**Step 1:** A serial Modbus master do the request to the Converter to read/write a register from the serial slave Modbus ID 2;

**Step 2:** The Converter sends to the TCP slave 192.168.0.19 the read/write request using the TCP slave ID 1;

**Step 3:** The slave TCP replies to the Converter with the data;

**Step 4:** The Converter sends back the data on serial.

**EXAMPLE 3:**

Taking the third row of Figure 4:

**Step 1:** A serial Modbus master do the request to the Converter to read/write a register from the serial slave Modbus ID 4;

**Step 2:** The Converter sends to the TCP slave 192.168.0.20 the read/write request using the TCP slave ID 4;

**Step 3:** The slave TCP replies to the Converter with the data;

**Step 4:** The Converter sends back the data on serial.

**Note:**

If the TCP slave responds with an exception, that exception code will be transmitted to the serial master. If the TCP slave does not respond within the estimated time defined by the Timeout parameter, an exception response will be given: error code \$36.

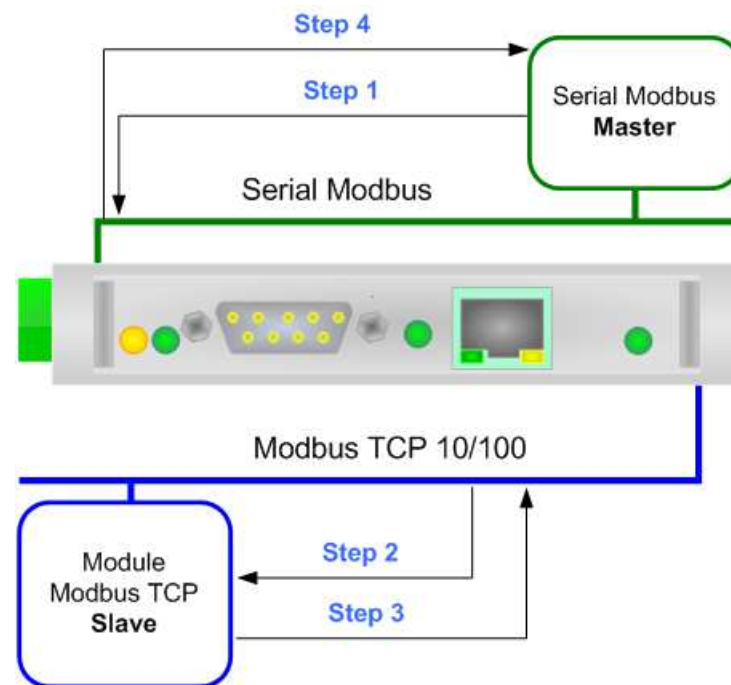

Figure 7: Chart of Request data from serial Modbus

**WORK WITH FIX IP ADDRESS:**

Using this function, the converter can be seen like a single serial Modbus slave. The address of Modbus is assigned in the "Set Communication" section.

In this working mode it is not necessary to compile a Translate Table; every request that arrives on serial is transferred on TCP (using TCP format of frame) to the slave with the IP address defined in the "Set Communication" section.

**EXAMPLE 1:**

Using the configuration of Figure 3:

- Step 1:** A serial Modbus master do the request to the Converter to read/write a register from the RTU Slave Address 1;
- Step 2:** The Converter sends to the TCP slave 192.168.0.20 the read/write request;
- Step 3:** The slave TCP replies to the Converter with the data;
- Step 4:** The Converter sends back the data on serial.

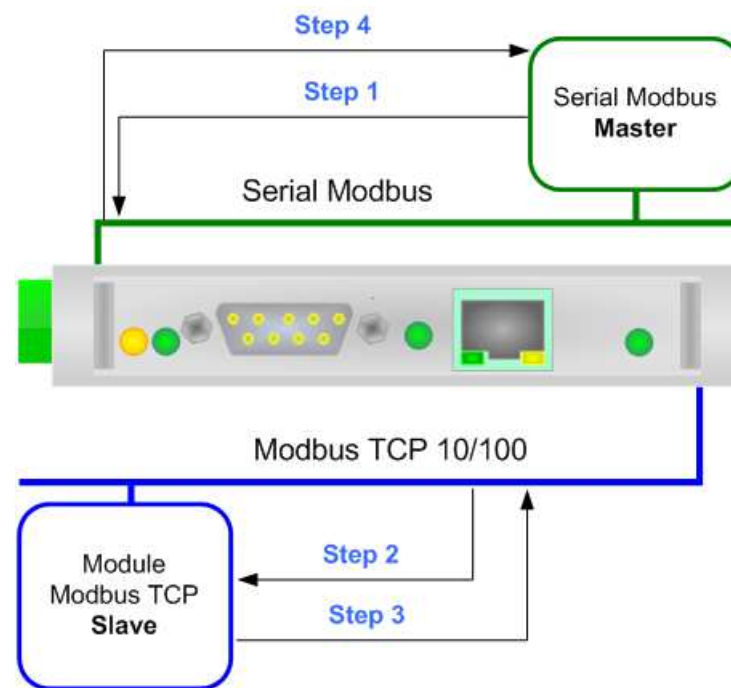

Figure 8: Chart of Request data from serial Modbus

**Note:** If the TCP slave responds with an exception, that exception code will be transmitted to the serial master. If the TCP slave does not respond within the estimated time defined by the Timeout parameter, an exception response will be given: error code \$36.

### UPDATE VIA SERIAL (only for hardware with jumpers):

By pressing the **Update Via Serial** button it is possible to load the created configuration into the device, and also the Firmware if is necessary. This by using the RS232 port.

In order to load the parameters or update the firmware in the device, follow these instructions:

- Turn OFF the Device;
- Connect the RS232 Null Modem cable form your PC to the Converter;
- Put Dip2 of 'Dip-Switch A' in ON position;
- Select the **COM port** and press the **Connect** button;
- Turn ON the device;
- Check the "Device state" Led. It must blink quickly (see "LEDS" section);
- Press the **Next** button;
- Select which operations you want to do.
- Press the **Execute Update Firmware** button to start the upload;
- When all the operations are "OK", turn OFF the device;
- Put Dip2 of 'Dip-Switch A' in OFF position;
- Disconnect the RS232 cable;
- Turn ON the device.

At this point the configuration/firmware on the device is correctly updated.

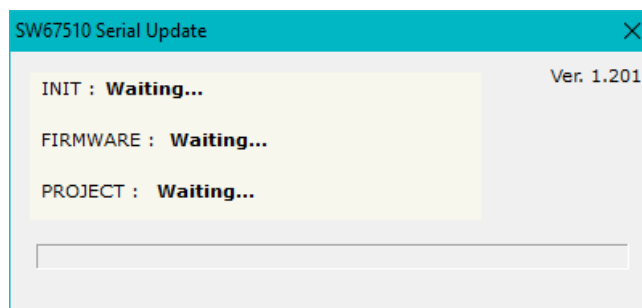
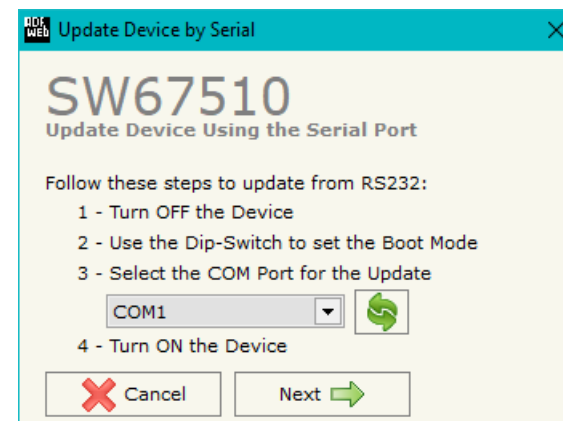

Figure 9: "Update Device" windows



**UPDATE VIA UDP (only for hardware with dip-switches):**

By pressing the **“Update via UDP”** button, it is possible to load the created configuration into the device; and also the Firmware, if necessary. This by using the Ethernet port.

If you don't know the actual IP address of the device you have to use this procedure:

- Turn OFF the Device;
- Put Dip2 of 'Dip-Switch A' in ON position;
- Turn ON the device
- Connect the Ethernet cable;
- Insert the IP **“192.168.2.205”**;
- Press the **“Ping”** button, “Device Found! must appear”;
- Press the **“Next”** button;
- Select which operations you want to do;
- Press the **“Execute update firmware”** button to start the upload;
- When all the operations are “OK”, turn OFF the Device;
- Put Dip2 of 'Dip-Switch A' in OFF position;
- Turn ON the device.

If you know the actual IP address of the device, you have to use this procedure:

- Turn ON the Device with the Ethernet cable inserted;
- Insert the actual IP of the Converter;
- Press the **“Ping”** button, must appear “Device Found!”;
- Press the **“Next”** button;
- Select which operations you want to do;
- Press the **“Execute update firmware”** button to start the upload;
- When all the operations are “OK” the device automatically goes at Normal Mode.

At this point the configuration/firmware on the device is correctly updated.

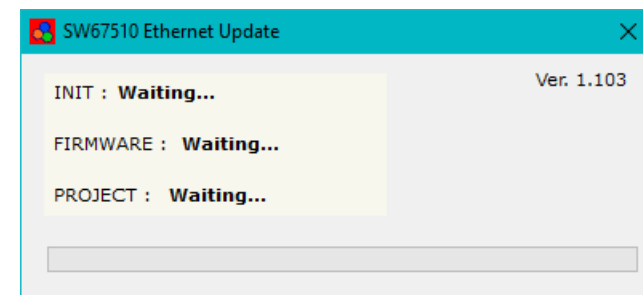
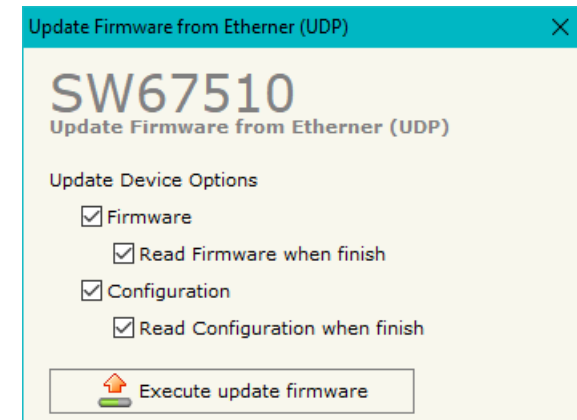
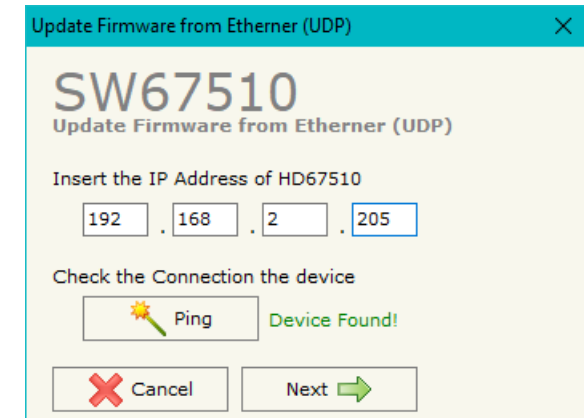





Figure 10: “Update device” windows

 **Note:**  
When you install a new version of the software, if it is the first time it is better you do the update of the Firmware in the HD67510 device.

 **Note:**  
When you receive the device, for the first time, you also have to update the Firmware in the HD67510 device.

 **Warning:**  
If Fig. 11 appears when you try to do the Update try these points before seeking assistance:

- Check if the serial COM port selected is the correct one;
- Check if the serial cable is connected between the PC and the device;
- If you are using a USB↔RS232 converter try with a native COM port or change the converter;
- Try to repeat the operations for the updating;
- Try with another PC;
- Try to restart the PC;
- Check the LAN settings;
- If you are using the program inside a Virtual Machine, try to use in the main Operating System;
- If you are using Windows Seven, Vista, 8 or 10 make sure that you have the administrator rights;
- In case you have to program more than one device, using the "UDP Update", you have to cancel the ARP table every time you connect a new device on Ethernet. For do this you have to launch the "Command Prompt" and write the command "arp -d". Pay attention that with Windows Vista, Seven, 8 you have to launch the "Command Prompt" with Administrator Rights;
- Pay attention at Firewall lock.

 **Warning:**  
In the case of HD67510 you have to use the software "SW67510": [www.adfweb.com/download/filefold/SW67510.zip](http://www.adfweb.com/download/filefold/SW67510.zip).

 **Note:**  
The minimum version of the configuration software must be the 2.000.

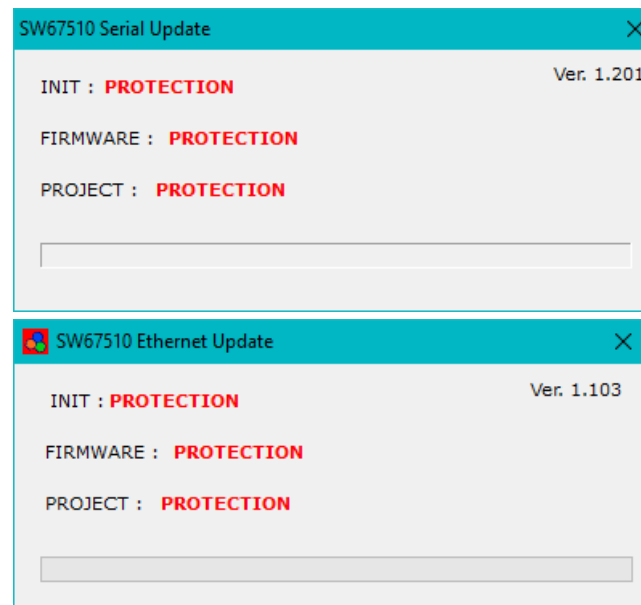
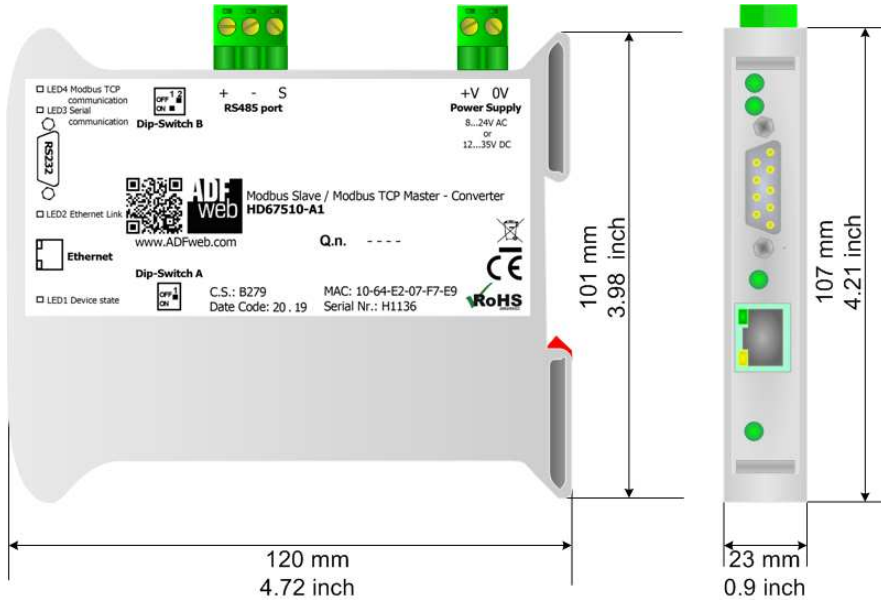

Figure 11: "Protection" windows

**MECHANICAL DIMENSIONS:**



Housing: PVC  
Weight: 200g (Approx)

Figure 12a: Mechanical dimensions scheme for HD67510-A1

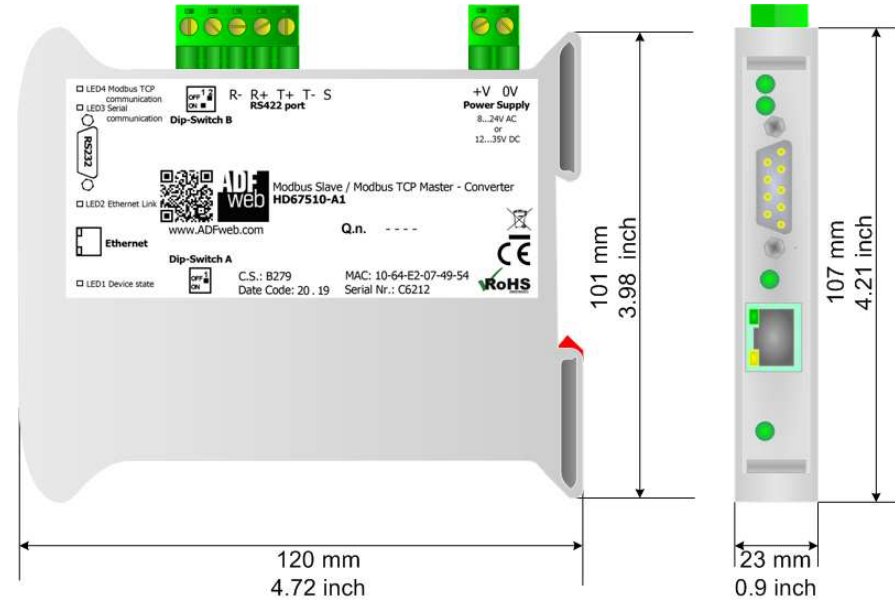

Housing: PVC  
Weight: 200g (Approx)

Figure 12b: Mechanical dimensions scheme for HD67510-A1-422

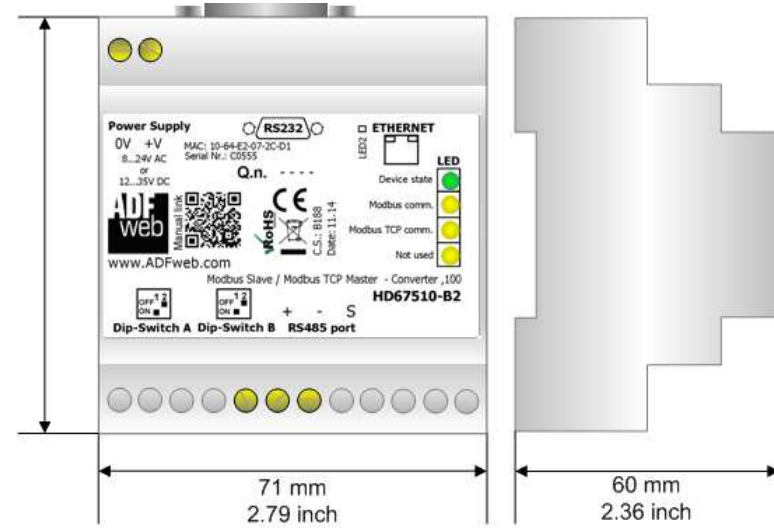

Housing: PVC  
 Weight: 200g (Approx)

Figure 12c: Mechanical dimensions scheme for HD67510-B2

### ORDERING INFORMATIONS:

The ordering part number is formed by a valid combination of the following:

#### **HD67510 - A 1 - 422**

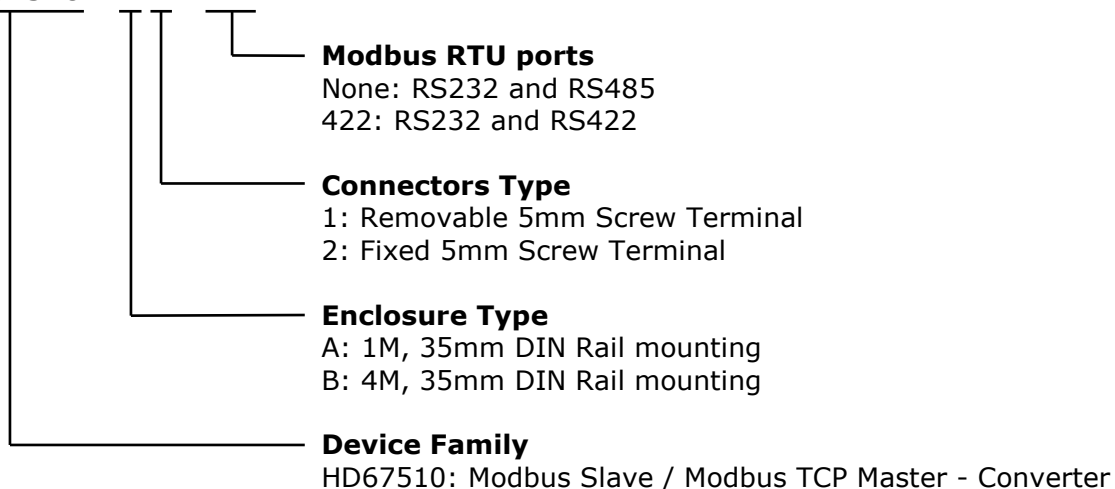

- Order Code: **HD67510-A1** - Modbus Slave / Modbus TCP Master - Converter ( Housing type: A, Terminal Blocks Connectors )
- Order Code: **HD67510-A1-422** - Modbus Slave / Modbus TCP Master - Converter ( Housing type: A, Terminal Blocks Connectors )
- Order Code: **HD67510-B2** - Modbus Slave / Modbus TCP Master - Converter ( Housing type: B, Terminal Blocks Connectors )

### ACCESSORIES:

- Order Code: **AC34107** - Null Modem Cable Fem/Fem D-sub 9 Pin 1,5 m
- Order Code: **AC34114** - Null Modem Cable Fem/Fem D-sub 9 Pin 5 m
- Order Code: **AC34001** - Rail DIN - Power Supply 220/240V AC 50/60Hz - 12 V AC
- Order Code: **AC34002** - Rail DIN - Power Supply 110V AC 50/60Hz - 12 V AC

**DISCLAIMER:**

All technical content within this document can be modified without notice. The content of the document is a under continual renewal. For losses due to fire, earthquake, third party access or other accidents, or intentional or accidental abuse, misuse, or use under abnormal conditions repairs are charged to the user. ADFweb.com S.r.l. will not be liable for accidental loss of use or inability to use this product, such as loss of business income. ADFweb.com S.r.l. shall not be liable for consequences of improper use.

**OTHER REGULATIONS AND STANDARDS:****WEEE INFORMATION**

Disposal of old electrical and electronic equipment (as in the European Union and other European countries with separate collection systems).

— This symbol on the product or on its packaging indicates that this product may not be treated as household rubbish. Instead, it should be taken to an applicable collection point for the recycling of electrical and electronic equipment. If the product is disposed correctly, you will help prevent potential negative environmental factors and impact of human health, which could otherwise be caused by inappropriate disposal. The recycling of materials will help to conserve natural resources. For more information about recycling this product, please contact your local city office, your household waste disposal service or the shop where you purchased the product.

**RESTRICTION OF HAZARDOUS SUBSTANCES DIRECTIVE**

The device respects the 2002/95/EC Directive on the restriction of the use of certain hazardous substances in electrical and electronic equipment (commonly referred to as Restriction of Hazardous Substances Directive or RoHS).

**CE MARKING**

The product conforms with the essential requirements of the applicable EC directives.



**WARRANTIES AND TECHNICAL SUPPORT:**

For fast and easy technical support for your ADFweb.com SRL products, consult our internet support at [www.adfweb.com](http://www.adfweb.com). Otherwise contact us at the address [support@adfweb.com](mailto:support@adfweb.com)

**RETURN POLICY:**

If while using your product you have any problem and you wish to exchange or repair it, please do the following:

- Obtain a Product Return Number (PRN) from our internet support at [www.adfweb.com](http://www.adfweb.com). Together with the request, you need to provide detailed information about the problem.
- Send the product to the address provided with the PRN, having prepaid the shipping costs (shipment costs billed to us will not be accepted).

If the product is within the warranty of twelve months, it will be repaired or exchanged and returned within three weeks. If the product is no longer under warranty, you will receive a repair estimate.



**ADFweb.com S.r.l.**  
Via Strada Nuova, 17  
IT-31010 Mareno di Piave  
TREVISO (Italy)  
Phone +39.0438.30.91.31  
Fax +39.0438.49.20.99  
[www.adfweb.com](http://www.adfweb.com)

