

User Manual

Revision 1.100
English

PROFIBUS Slave / Modbus TCP Master - Converter

(Order Code: HD67564-A1, HD67564M)

For Website information:

Benefits and Main Features:

Triple electrical isolation

Two Ethernet ports

Temperature range: -40°C/+85°C (-40°F/+185°F)



HD67564-A1



HD67564M

For others Gateway / Adapters:

PROFIBUS to

See also the following link:



User Manual

INDEX:

	Page
INDEX	2
UPDATED DOCUMENTATION	2
REVISION LIST	2
WARNING	2
TRADEMARKS	2
SECURITY ALERT	3
EXAMPLES OF CONNECTION	4
CONNECTION SCHEME	5
CHARACTERISTICS	7
CONFIGURATION	7
POWER SUPPLY	8
FUNCTION MODES	9
LEDS (for HD67564-A1)	10
LEDS (for HD67564M)	11
PROFIBUS	12
ETHERNET	13
RS232 (only for HD67564M)	13
USE OF COMPOSITOR SW67564	14
NEW PROJECT / OPEN PROJECT	15
SOFTWARE OPTIONS	16
SET COMMUNICATION	17
SET ACCESS	19
PROFIBUS GSD	21
UPDATE VIA SERIAL (only for HD67564M)	22
UPDATE VIA UDP (only for HD67564-A1)	23
MECHANICAL DIMENSIONS	25
ORDERING INFORMATIONS	27
ACCESSORIES	27
DISCLAIMER	28
OTHER REGULATIONS AND STANDARDS	28
WARRANTIES AND TECHNICAL SUPPORT	29
RETURN POLICY	29

UPDATED DOCUMENTATION:

Dear customer, we thank you for your attention and we remind you that you need to check that the following document is:

- ✚ Updated
- ✚ Related to the product you own

To obtain the most recently updated document, note the “document code” that appears at the top right-hand corner of each page of this document.

With this “Document Code” go to web page www.adfweb.com/download/ and search for the corresponding code on the page. Click on the proper “Document Code” and download the updates.

REVISION LIST:

Revision	Date	Author	Chapter	Description
1.001	15/07/2009	MI	All	Revision
1.002	24/06/2010	Ft	All	Revision
1.003	11/01/2013	Nt & FI	All	Added new chapters
1.100	15/09/2015	Ff	All	Added A1 version

WARNING:

ADFweb.com reserves the right to change information in this manual about our product without warning. ADFweb.com is not responsible for any error this manual may contain.

TRADEMARKS:

All trademarks mentioned in this document belong to their respective owners.

SECURITY ALERT:**GENERAL INFORMATION**

To ensure safe operation, the device must be operated according to the instructions in the manual. When using the device, legal and safety regulation are required for each individual application. The same applies also when using accessories.

INTENDED USE

Machines and systems must be designed so the faulty conditions do not lead to a dangerous situation for the operator (i.e. independent limit switches, mechanical interlocks, etc.).

QUALIFIED PERSONNEL

The device can be used only by qualified personnel, strictly in accordance with the specifications.

Qualified personnel are persons who are familiar with the installation, assembly, commissioning and operation of this equipment and who have appropriate qualifications for their job.

RESIDUAL RISKS

The device is state-of-the-art and is safe. The instruments can represent a potential hazard if they are inappropriately installed and operated by untrained personnel. These instructions refer to residual risks with the following symbol:



This symbol indicates that non-observance of the safety instructions is a danger for people that could lead to serious injury or death and / or the possibility of damage.

CE CONFORMITY

The declaration is made by our company. You can send an email to or give us a call if you need it.

EXAMPLE OF CONNECTION:

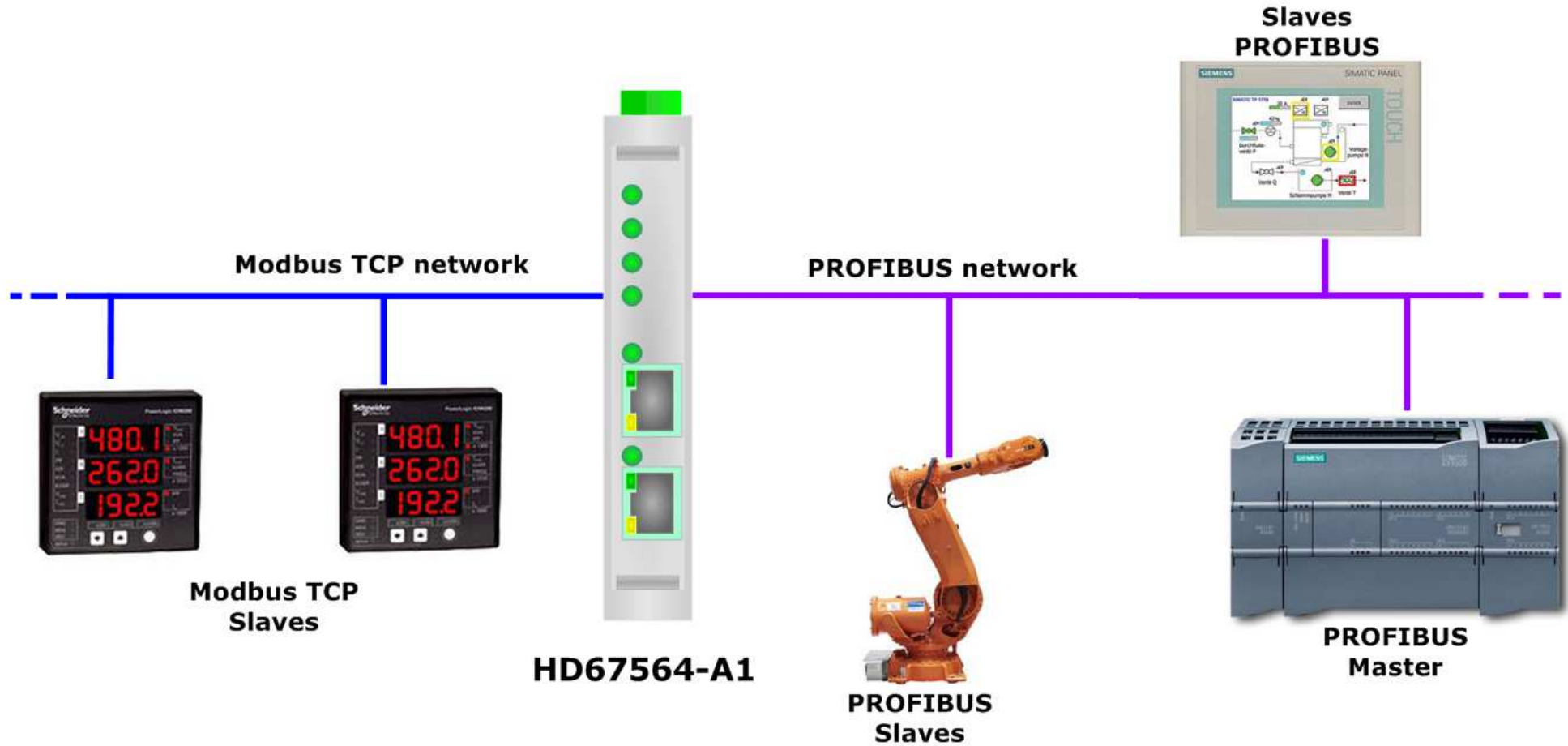

CONNECTION SCHEME:

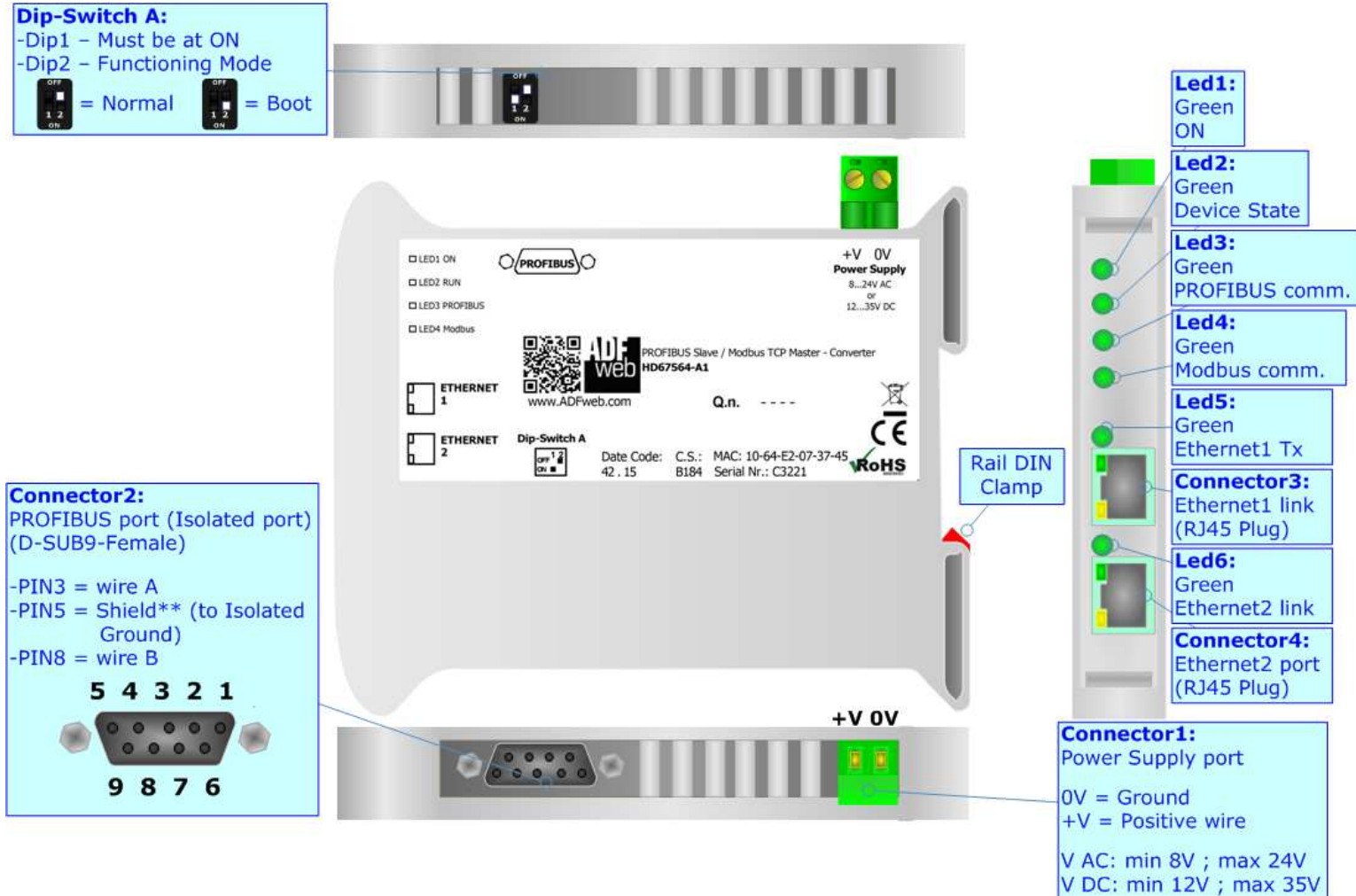

Figure 1a: Connection scheme for HD67564-A1

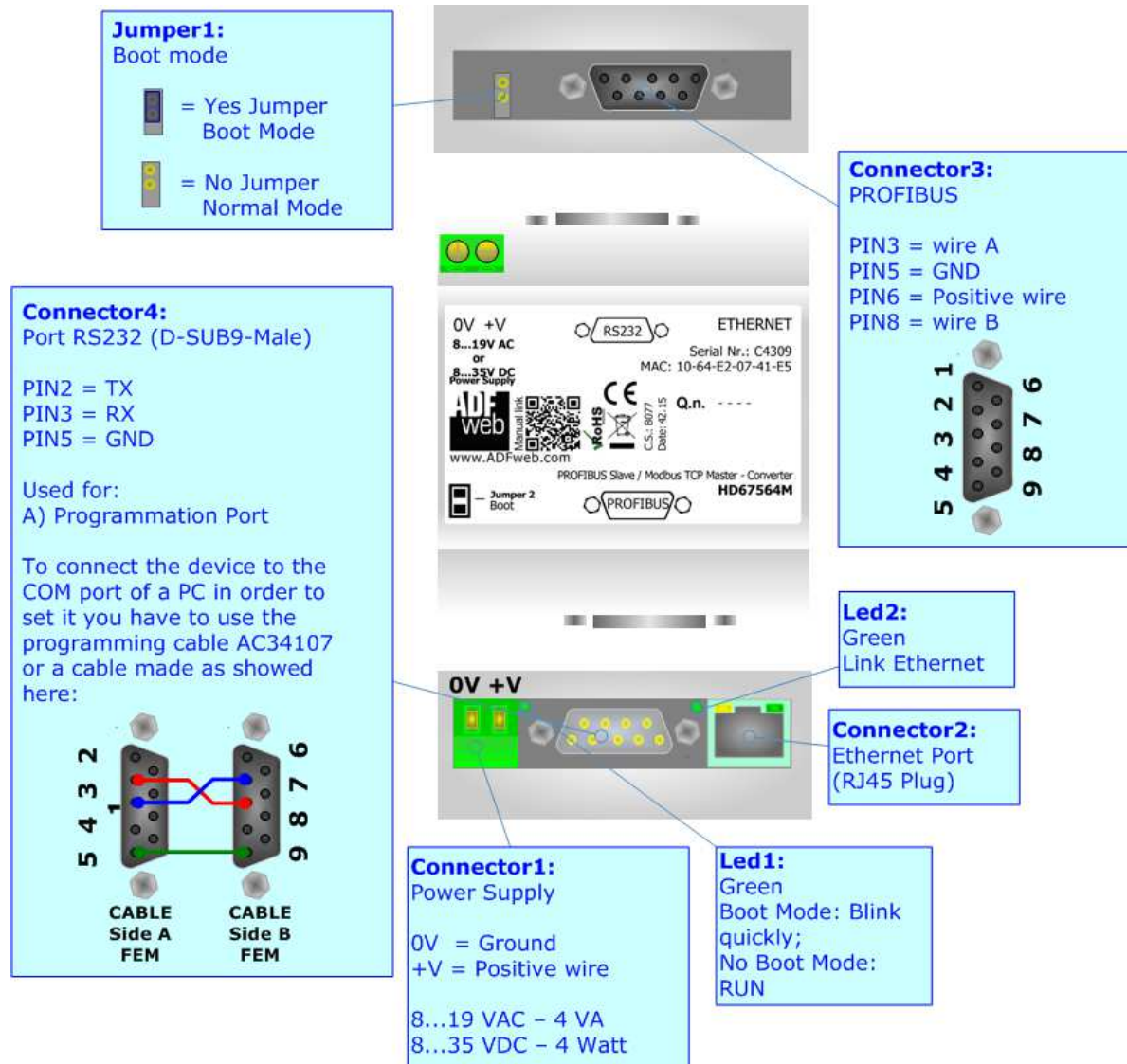

Figure 1b: Connection scheme for HD67564M

CHARACTERISTICS:

The HD67564-A1 and HD67564M are a PROFIBUS Slave / Modbus TCP Master Converter.

They allow the following characteristics:

- Two-directional information between Modbus TCP network and PROFIBUS;
- Electrical isolation between two buses;
- Up to 244 bytes in reading and 244 bytes in writing;
- Power Supply 8...19V AC or 8...35V DC;
- Mountable on 35mm Rail DIN;
- Temperature range -40°C to 85°C.

CONFIGURATION:

You need Compositor SW67564 software on your PC in order to perform the following:

- Define the parameter of the PROFIBUS;
- Define the parameter of Modbus TCP;
- Define which Modbus registers read/write from/to the Modbus TCP slaves;
- Define in/from which PROFIBUS bytes map/take the data;
- Create a GSD file;
- Update the device.

POWER SUPPLY:

The devices can be powered at 8...24V AC and 12...35V DC (for the HD67564-A1) and at 8...19V AC and 8...35V DC (for HD67564M). The consumption depends to the code of the device. For more details see the two tables below.

VAC		VDC	
Vmin	Vmax	Vmin	Vmax
8V	24V	12V	35V

HD67564-A1

VAC		VDC	
Vmin	Vmax	Vmin	Vmax
8V	19V	8V	35V

HD67564M

Consumption at 24V DC:

Device	Consumption [W/VA]
HD67564-A1	3.5
HD67564M	3.5

Connector1:
Power Supply port
0V = Ground
+V = Positive wire
V AC: min 8V ; max 24V
V DC: min 12V ; max 35V



Connector1:
Power Supply
0V = Ground
+V = Positive wire
8...19 VAC – 4 VA
8...35 VDC – 4 Watt



Caution: Not reverse the polarity power

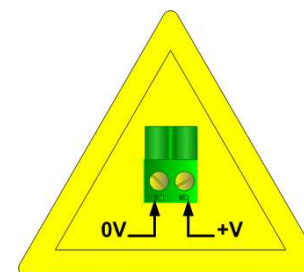

HD67564-A1

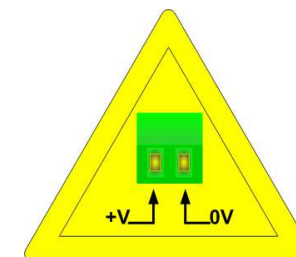

HD67564M

FUNCTION MODES:

HD67564-A1

The HD67564-A1 has got two functions mode depending of the position of the 'Dip2 of Dip-Switch A':

- The first, with 'Dip2 of Dip-Switch A' at "OFF" position, is used for the normal working of the device.
- The second, with 'Dip2 of Dip-Switch A' at "ON" position, is used for upload the Project and/or Firmware.



Warning: Dip1 of 'Dip-Switch A' must be at ON position for working even if the Ethernet cable isn't inserted.

HD67564M

The HD67564M has got two functions mode depending of the position of the 'Jumper1':

- The first, with 'Jumper1' not inserted, is used for the normal working of the device.
- The second, with 'Jumper1' inserted, is used for upload the Project and/or Firmware.

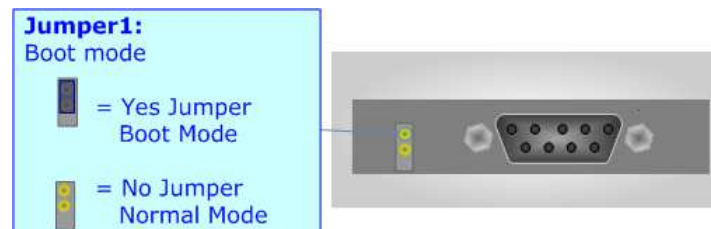

For the operations to follow for the updating, see 'UPDATE DEVICE' section.
 According to the functioning mode, the LEDs will have specifics functions, see 'LEDS' section.

LEDS (HD67564-A1):

The device has got six LEDs that are used to give information of the functioning status. The various meanings of the LEDs are described in the table below.

LED	Normal Mode	Boot Mode
1: ON [supply voltage] (green)	ON: Device powered OFF: Device not powered	ON: Device powered OFF: Device not powered
2: Device State (green)	Blinks slowly (~1Hz)	Blinks quickly: Boot state Blinks very slowly (~0.5Hz): update in progress
3: PROFIBUS communication (green)	Flashing: PROFIBUS communication is working correctly OFF: PROFIBUS communication is not working	Blinks quickly: Boot state Blinks very slowly (~0.5Hz): update in progress
4: Modbus communication (green)	Changes state when a correct Modbus response is received	Blinks quickly: Boot state Blinks very slowly (~0.5Hz): update in progress
5: Ethernet1 link (green)	ON: Ethernet cable connected OFF: Ethernet cable not connected	Blinks quickly: Boot state Blinks very slowly (~0.5Hz): update in progress
6: Ethernet2 link (green)	ON: Ethernet cable connected OFF: Ethernet cable not connected	Blinks quickly: Boot state Blinks very slowly (~0.5Hz): update in progress

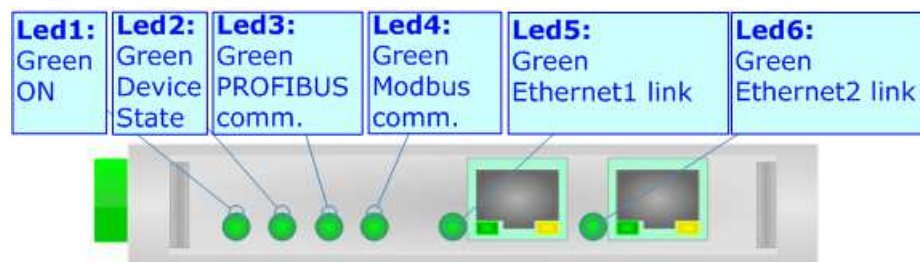

LEDS (HD67564M):

The device has got two LEDs that are used to give information of the functioning status. The various meanings of the LEDs are described in the table below.

LED	Normal Mode	Boot Mode
1: Device State (green)	Blinks slowly (~1Hz)	Blinks quickly
2: Ethernet link (green)	ON: Ethernet cable connected OFF: Ethernet cable not connected	OFF

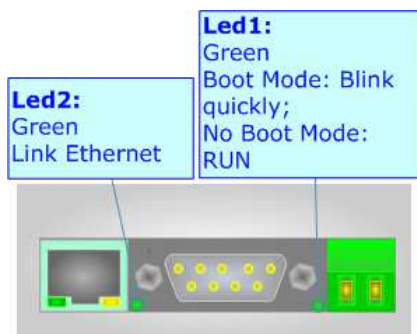

PROFIBUS:

The PROFIBUS uses a 9-pin D-SUB connector. The pin assignment is defined like in the following figure.

Here some codes of cables:

- ✦ Belden: p/n 183079A - Continuous Armor DataBus® ISA/SP-50 PROFIBUS Cable.

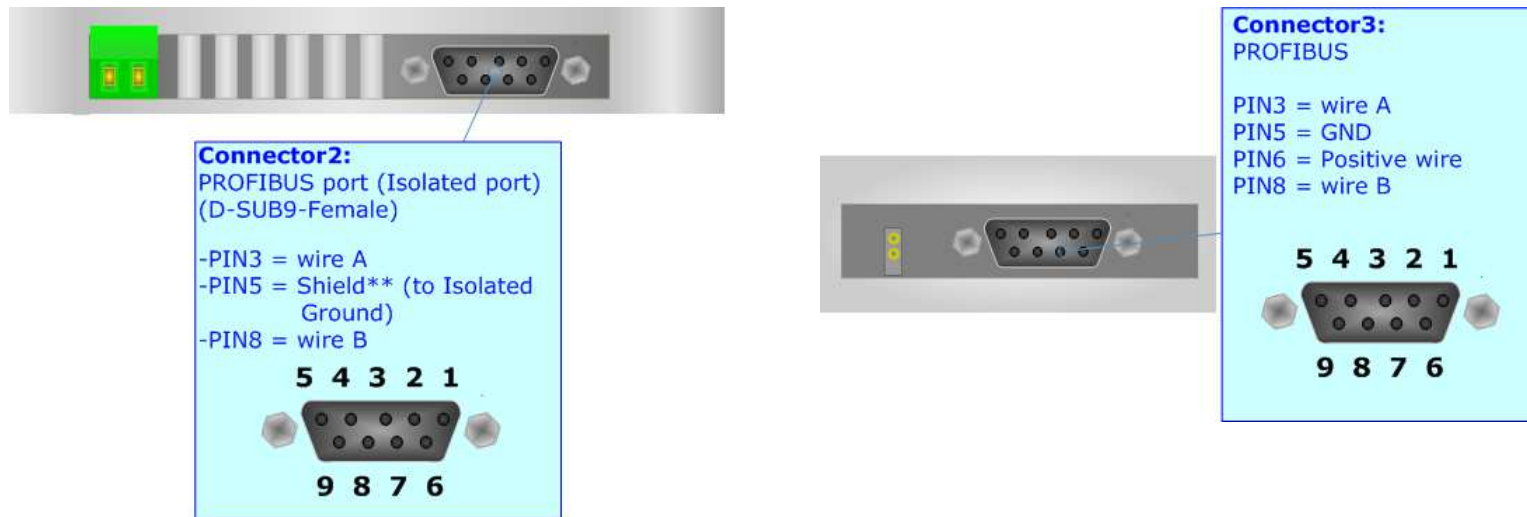

ETHERNET:

The Ethernet connection must be made using Connector2/3/4 of HD67564-A1/HD67564M with at least a Category 5E cable. The maximum length of the cable should not exceed 100m. The cable has to conform to the T568 norms relative to connections in cat.5 up to 100 Mbps. To connect the device to an Hub/Switch is recommended the use of a straight cable, to connect the device to a PC/PLC/other is recommended the use of a cross cable.

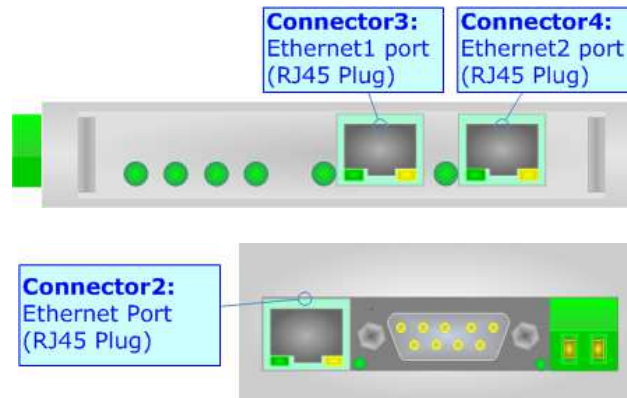

RS232 (only for HD67564M):

The connection from RS232 socket to a serial port (example one from a personal computer), must be made with a Null Modem cable (a serial cable where the pins 2 and 3 are crossed). It is recommended that the RS232C Cable not exceed 15 meters. The serial port is used for programming the device.

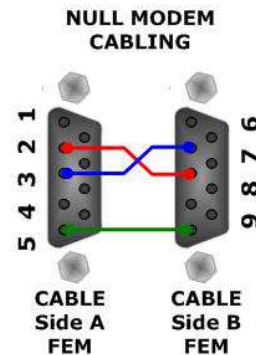

USE OF COMPOSITOR SW67564:

To configure the Converter, use the available software that runs with Windows called SW67564. It is downloadable on the site www.adfweb.com and its operation is described in this document. *(This manual is referenced to the last version of the software present on our web site)*. The software works with MSWindows (XP, Vista, Seven, 8, 10; 32/64bit).

When launching the SW67564, the window below appears (Fig. 2).



Note:

It is necessary to have installed .Net Framework 4.

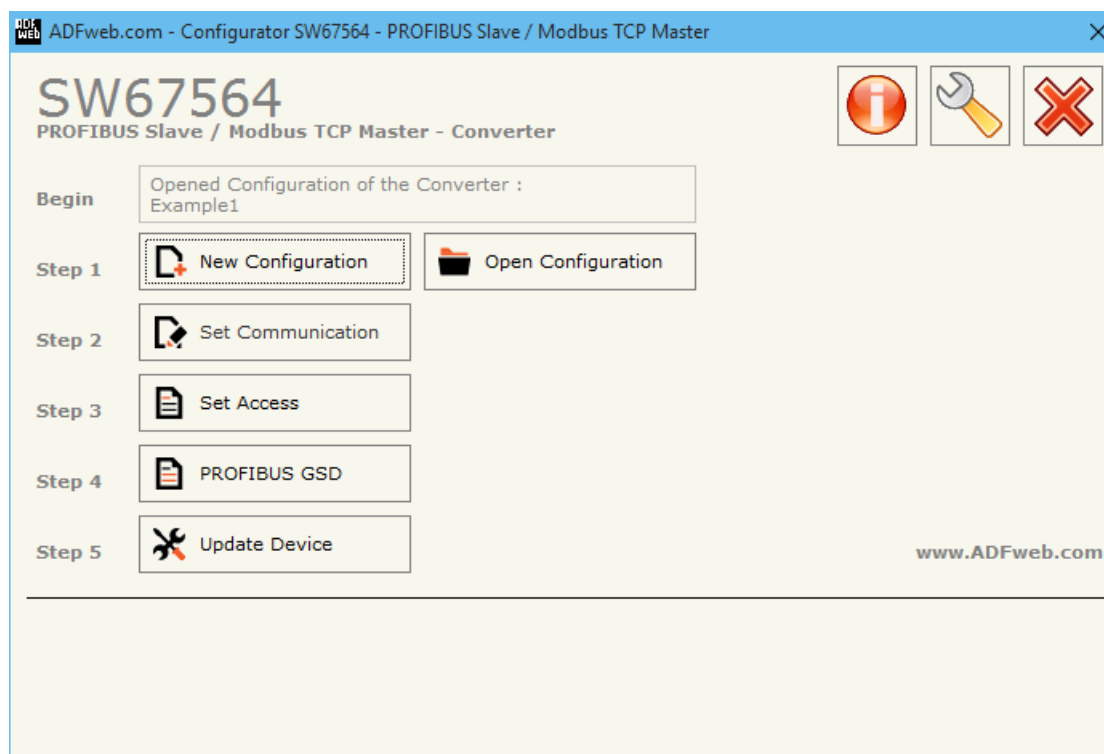
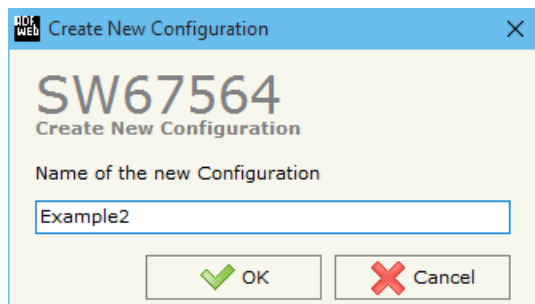

Figure 2: Main window for SW67564

NEW CONFIGURATION / OPEN CONFIGURATION:

The “**New Configuration**” button creates the folder which contains the entire device’s configuration.



A device’s configuration can also be imported or exported:

- To clone the configurations of a Programmable “PROFIBUS Slave / Modbus TCP Master - Converter” in order to configure another device in the same manner, it is necessary to maintain the folder and all its contents;
- To clone a project in order to obtain a different version of the project, it is sufficient to duplicate the project folder with another name and open the new folder with the button “**Open Configuration**”.

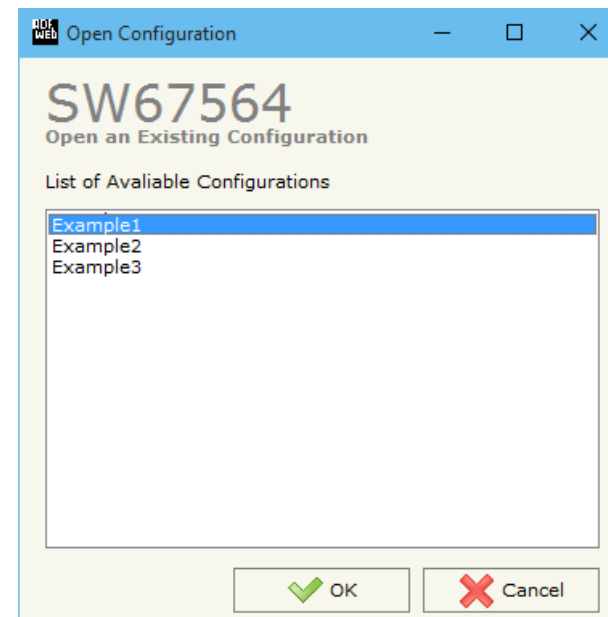

SOFTWARE OPTIONS:

By pressing the “**Settings**” () button there is the possibility to change the language of the software and check the updatings for the compositor.

In the section “Language” it is possible to change the language of the software.

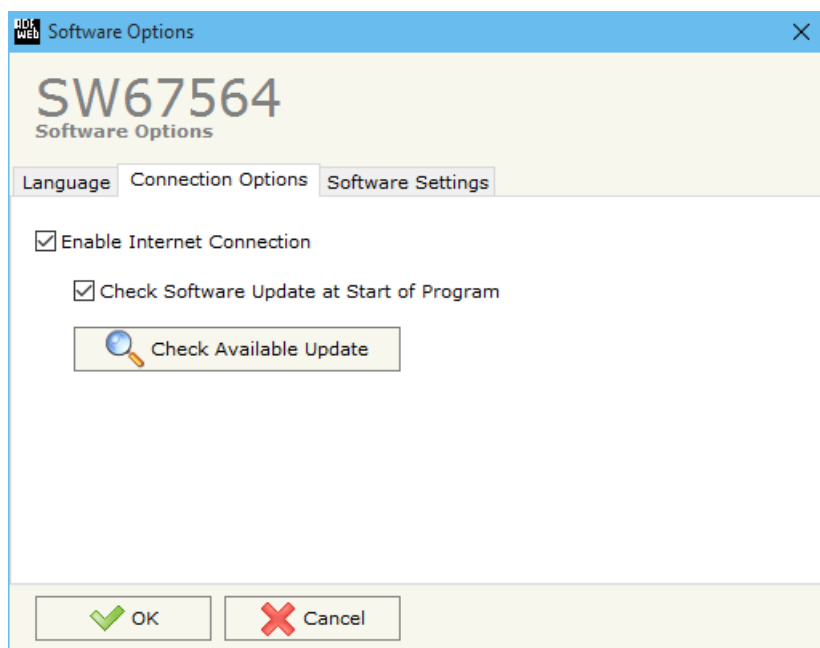

In the section “Connection Options”, it is possible to check if there are some updatings of the software compositor in ADFweb.com website. Checking the option “**Check Software Update at Start of Program**”, the SW67564 check automatically if there are updatings when it is launched.

SET COMMUNICATION:

This section defines the fundamental communication parameters of two buses, PROFIBUS and Modbus TCP.

By pressing the **"Set Communication"** button from the main window for SW67564 (Fig. 2) the window "Set Communication" appears (Fig. 3).

The window is divided in three sections, one for selecting the device used, one for the Modbus TCP (Ethernet) and one for the PROFIBUS.

In the section **"Select Device"** is possible to select the type of converter used:

- HD67564-A1 ("Device from May 2014 (with Dip-Switch)");
- HD67564M ("Device till April 2014 (with Jumper)").

The means of the fields for **"Modbus TCP Master"** are:

- In the field **"IP ADDRESS"**, the IP address of the Modbus TCP side is defined;
- In the field **"SUBNET Mask"**, SubNet Mask of the Modbus TCP network is defined;
- If the field **"GATEWAY"** is checked, insert the default gateway that you want to use. This feature can be enabled or disabled pressing the Check Box field. This feature is used for going out of the net (only for HD67564-A1);
- In the field **"Port"**, the number of the port of the Modbus TCP side is defined (only for HD67564M);
- In the **"TimeOut (ms)"** define the maximum time that the converter waits for the answer from the slave interrogated;
- In the field **"Cyclic Delay (ms)"** the delay between two Modbus requests is defined;
- If the field **"Write Only When Data Change"** is checked, the converter sends the Modbus writing requests only when the data on PROFIBUS side change (only for HD67564M);
- If the field **"Don't Disconnect the Socket"** is checked, when the Converter receives the TCP response it does not disconnect the opened socket; otherwise for every request the Converter opens the socket and when it receives the TCP response it closes it (only for HD67564M).

The screenshot shows the 'Set Communication' window for device SW67564. The window is titled 'Set Communication' and has a close button (X) in the top right corner. The device name 'SW67564' is prominently displayed at the top. Below the title, there are three main sections: 'Select Device', 'Modbus TCP Master', and 'PROFIBUS Slave'. The 'Select Device' section has a dropdown menu showing 'HD67564M (Hardware with Jumper)'. The 'Modbus TCP Master' section includes fields for IP ADDRESS (192.168.0.10), SUBNET Mask (255.255.255.0), Port (502), and checkboxes for 'Don't Disconnect the Socket' and 'Write Only When Data Change'. It also has input fields for TimeOut (ms) (1000) and Cyclic Delay (ms) (100). The 'PROFIBUS Slave' section includes fields for ID Device (20), Baudrate (Auto Baudrate), Number Byte IN (244), and Number Byte Out (244). At the bottom, there are 'OK' and 'Cancel' buttons.

Figure 3: "Set Communication" window

The means of the fields for "**PROFIBUS Slave**" are:

- In the field "**ID Device**", the address of the PROFIBUS side is defined;
- In the field "**Baudrate**", the baudrate of the PROFIBUS side is defined (fixed to "Auto Baudrate");
- In the field "**Number Byte IN**", the number of Input bytes of PROFIBUS is defined (at maximum it is possible to use 244 byte);
- In the field "**Number Byte OUT**", the number of Output bytes of PROFIBUS is defined (at maximum it is possible to use 244 byte).

SET ACCESS:

By pressing the **Set Access** button from the main window for SW67564 (Fig. 2) the window "Set Modbus TCP Master Access" appears.

The window is divided in two parts, the "Modbus Read" and the "Modbus Write" table.

The first part (Modbus Read) is used to make available the data that is sent from the PROFIBUS Master to the Modbus TCP Client when it performs the reading requests.

The second part (Modbus Write) is used to create the Modbus registers which are updated by the Modbus TCP Client (when it performs the writing requests) to be transferred to the PROFIBUS.

If "Device till April 2014 (with Jumper)" is set in the section "Set Communication", the window appears like below:

- If the field **Enable** is checked, the Modbus TCP request is enabled;
- In the field **Slave IP Address**, the IP Address of the Modbus TCP slave is defined;
- In the field **Type** insert the data type of the Register you would like to read/write. You can choose between the following:
 - Coil Status (R/W);
 - Input Status (R);
 - Holding Register (R/W);
 - Input Register (R);
- In the field **Address** the start address of the register/status to read/write is defined;
- In the field **NPoint** the number of consecutive registers/status to read/write is defined;
- In the field **Position** the starting byte of the PROFIBUS array where mapping/taking the data is defined;
- In the field **Mnemonic**, a brief description is defined.

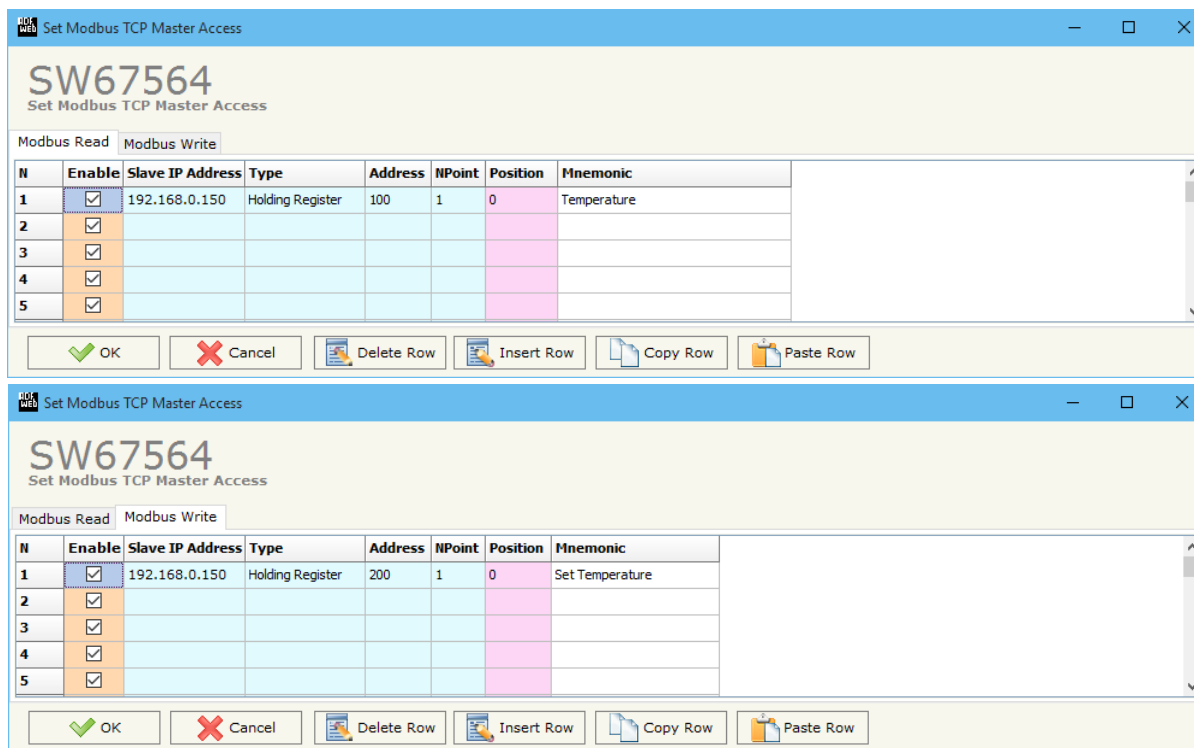

Figure 4a: "Set Access" windows

If "Device from May 2014 (with Dip-Switch)" is set in the section "Set Communication", the window appears like below:

- If the field "Enable" is checked, the Modbus TCP request is enabled;
- In the field "Slave IP Address", the IP Address of the Modbus TCP slave is defined;
- In the field "Port", the number of the port used for the Modbus TCP request is defined;
- In the field "Type" insert the data type of the Register you would like to read/write. You can choose between the following:
 - Coil Status (R/W);
 - Input Status (R);
 - Holding Register (R/W);
 - Input Register (R);
- In the field "Address" the start address of the register/status to read/write is defined;
- In the field "NPoint" insert the number of consecutive registers/status to read/write;
- In the field "Position" the starting byte of the PROFIBUS array where mapping/taking the data is defined;
- The field "Start Bit" is used for select from which Bit save the data (to use only when the "Type" is 'Coil Status' or 'Input Status' and the "NPoint" is more than one);
- In the field "Mnemonic", a brief description is defined.

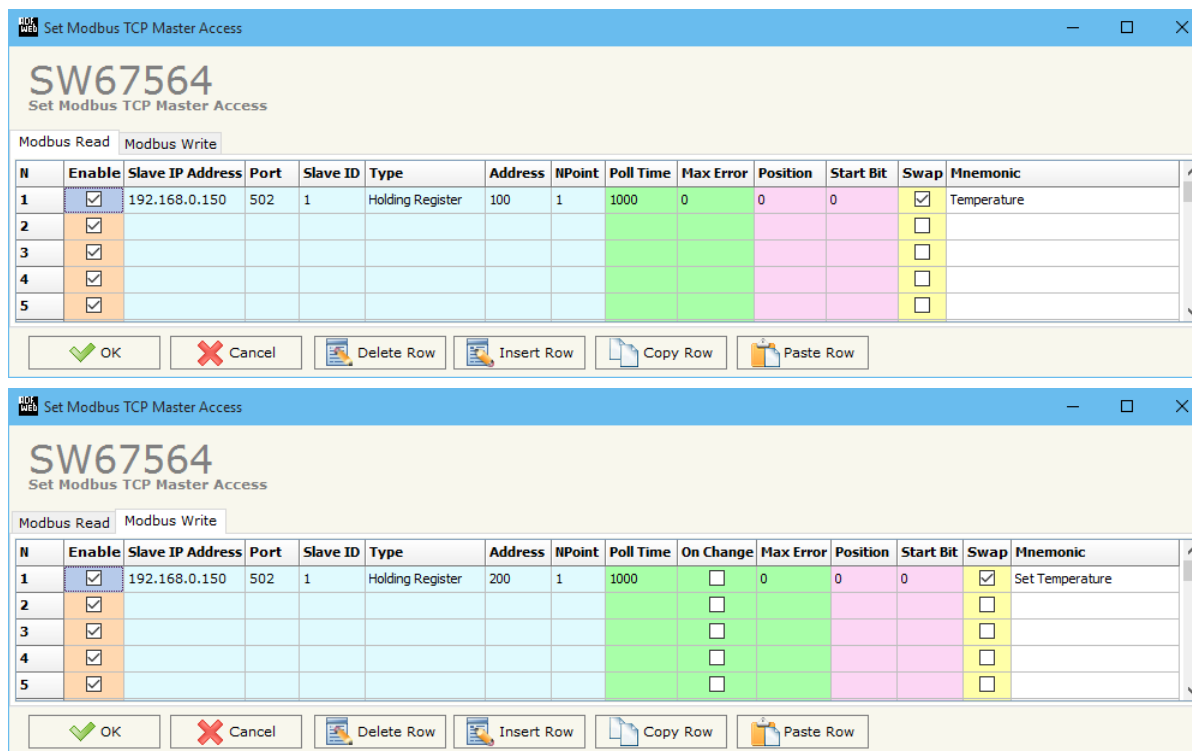

Figure 4b: "Set Access" windows

GSD FILE:

By pressing the "**PROFIBUS GSD**" button it is possible to save the GSD file for the PROFIBUS side. With this feature you can save the configuration of the gateway of the PROFIBUS side.

**Note:**

When you import the .gsd file on your Master PROFIBUS you have to add all the modules that are present inside it in the correct order.

UPDATE VIA SERIAL (only for the HD67564M):

By pressing the “**Update Device**” button it is possible to load the created Configuration into the device, and also the Firmware if is necessary, using the RS232 port.

In order to load the parameters or update the firmware in the device, follow these instructions:

- Turn off the Device;
- Connect the RS232 cable from your PC to the Converter;
- Insert the Jumper1 in the Boot Position;
- Select the “**COM port**” and press the “**Connect**” button;
- Turn on the device;
- Check the “Device state” Led. It must blink quickly (see “LEDS” section);
- Press the “**Next**” button;
- Select which operations you want to do.
- Press the “**Execute update firmware**” button to start the upload;
- When all the operations are “OK” turn off the device;
- Remove the Jumper1;
- Disconnect the RS232 cable;
- Turn on the device.

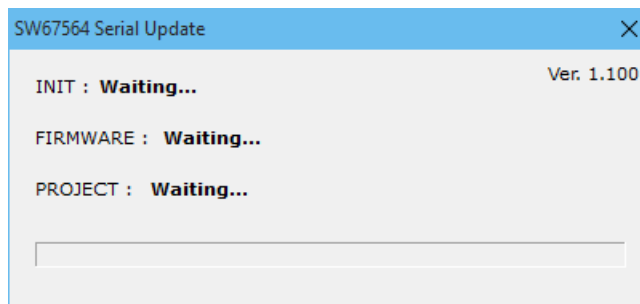
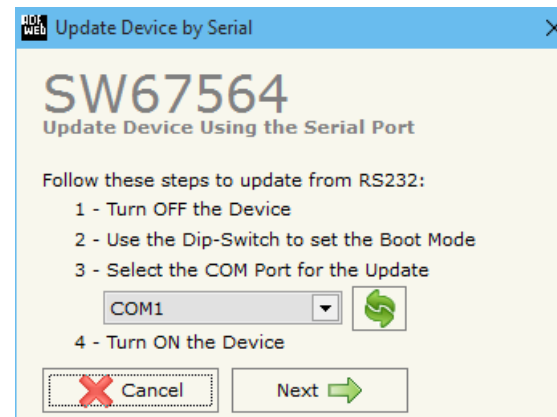

Figure 5: “Update via Serial” windows

UPDATE VIA UDP (only for HD67564-A1):

By pressing the **“Update Device”** button, it is possible to load the created Configuration into the device; and also the Firmware, if necessary.

If you don't know the actual IP address of the device you have to use this procedure:

- Turn off the Device;
- Put Dip2 of 'Dip-Switch A' in ON position;
- Turn on the device
- Connect the Ethernet cable;
- Insert the IP **“192.168.2.205”**;
- Press the **“Ping”** button, “Device Found! must appear”;
- Press the **“Next”** button;
- Select which operations you want to do;
- Press the **“Execute update firmware”** button to start the upload;
- When all the operations are “OK” turn off the Device;
- Put Dip2 of 'Dip-Switch A' in OFF position;
- Turn on the device.

At this point the configuration/firmware on the device is correctly updated.

If you know the actual IP address of the device, you have to use this procedure:

- Turn on the Device with the Ethernet cable inserted;
- Insert the actual IP of the Converter;
- Press the **“Ping”** button, must appear “Device Found!”;
- Press the **“Next”** button;
- Select which operations you want to do;
- Press the **“Execute update firmware”** button to start the upload;
- When all the operations are “OK” the device automatically goes at Normal Mode.

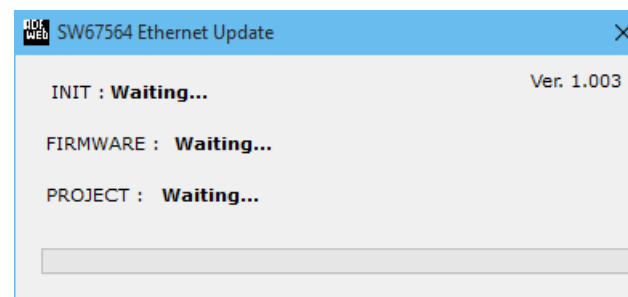
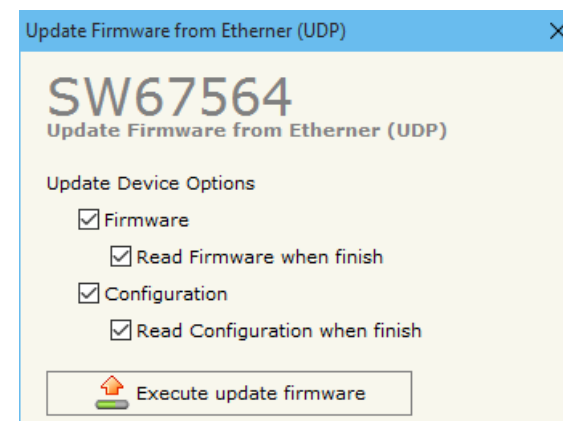
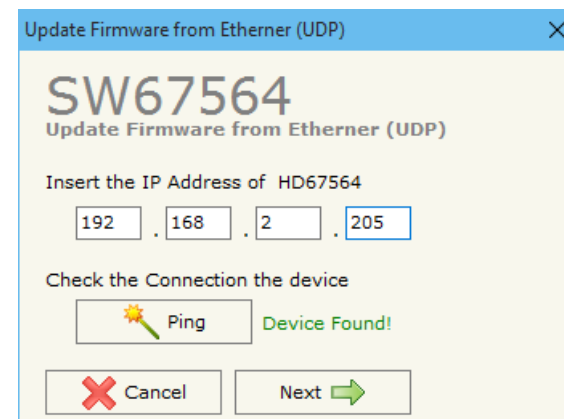

Figure 6: “Update via UDP” windows



Note:

When you install a new version of the software, if it is the first time it is better you do the update of the Firmware in the HD67564 device.



Note:

When you receive the device, for the first time, you also have to update the Firmware in the HD67564 device.



Warning:

If Fig. 7 appears when you try to do the Update try these points before seeking assistance:

- Check if the serial COM port selected is the correct one;
- Check if the serial cable is connected between the PC and the device;
- Try to repeat the operations for the updating;
- If you are using a USB↔RS232 converter try with a native COM port or change the converter;
- Try to repeat the operations for the updating;
- Try with another PC;
- Try to restart the PC;
- Check the LAN settings;
- If you are using the program inside a Virtual Machine, try to use in the main Operating System;
- If you are using Windows Seven, Vista and 8 make sure that you have the administrator privileges;
- In case you have to program more than one device, using the "UDP Update", you have to cancel the ARP table every time you connect a new device on Ethernet. For do this you have to launch the "Command Prompt" and write the command "arp -d". Pay attention that with Windows Vista, Seven, 8 you have to launch the "Command Prompt" with Administrator Rights;
- Pay attention at Firewall lock.

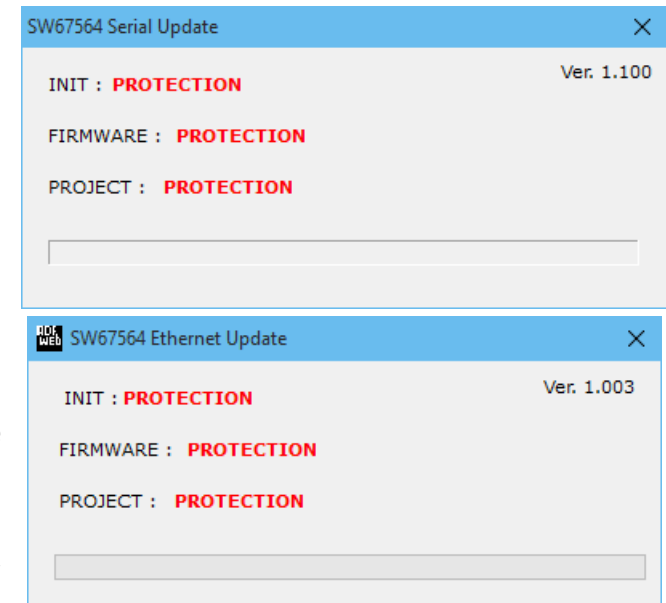

Figure 7: "Protection" windows

In the case of HD67564 you have to use the software "SW67564": www.adfweb.com/download/filefold/SW67564.zip.

MECHANICAL DIMENSIONS:

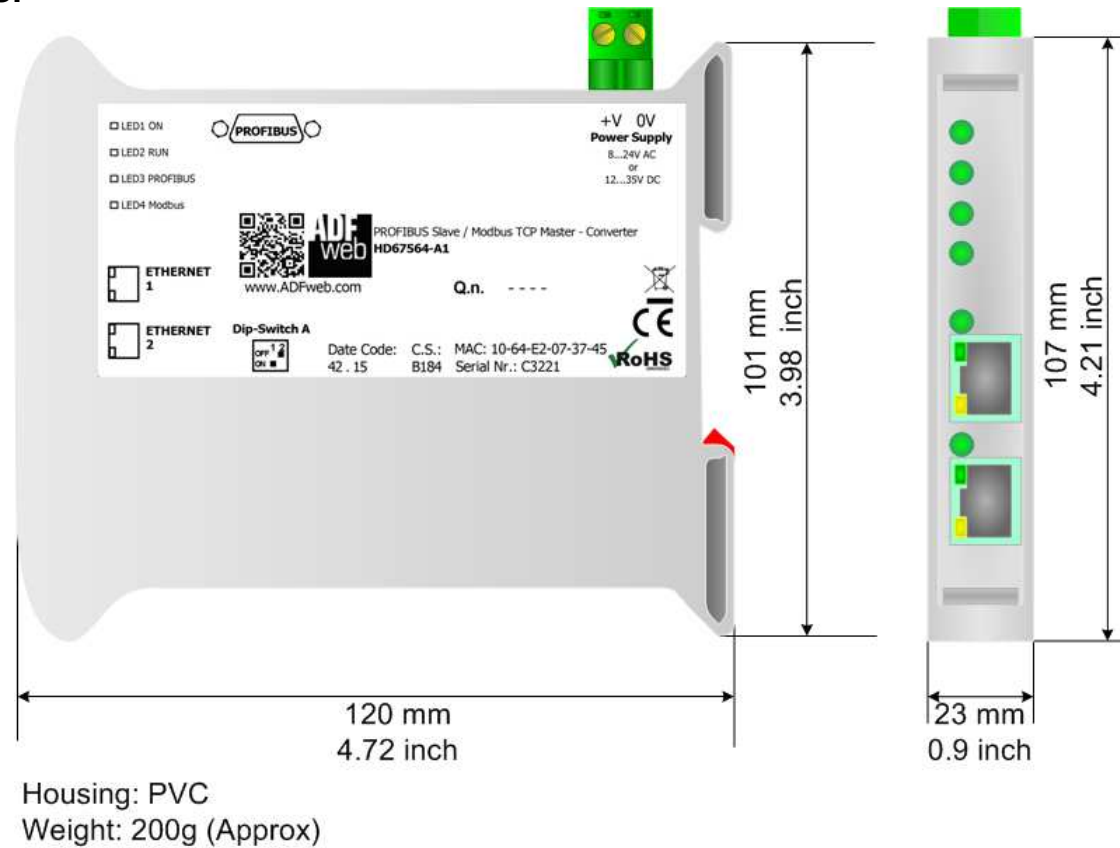
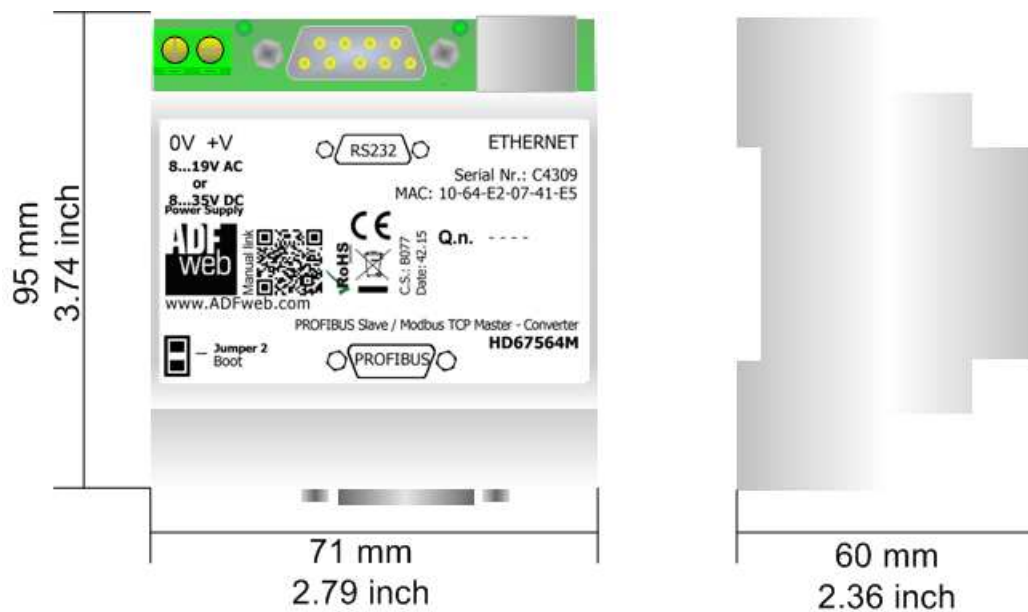

Figure 8a: Mechanical dimensions for HD67564-A1



Housing: PVC
Weight: 200g (Approx)

Figure 8b: Mechanical dimensions for HD67564M

ORDER CODE:

- Order Code: **HD67564-A1** - PROFIBUS Slave / Modbus TCP Master - Converter (Housing type: A, Terminal Blocks Connectors)
- Order Code: **HD67564M** - PROFIBUS Slave / Modbus TCP Master - Converter (Housing type: B, Terminal Blocks Connectors)

ACCESSORIES:

- Order Code: **AC34107** - Null Modem Cable Fem/Fem D-sub 9 Pin 1,5 m
- Order Code: **AC34114** - Null Modem Cable Fem/Fem D-sub 9 Pin 5 m
- Order Code: **AC34001** - Rail DIN - Power Supply 220/240V AC 50/60Hz – 12 V AC
- Order Code: **AC34002** - Rail DIN - Power Supply 110V AC 50/60Hz – 12 V AC

DISCLAIMER:

All technical content within this document can be modified without notice. The content of the document is a under continual renewal. For losses due to fire, earthquake, third party access or other accidents, or intentional or accidental abuse, misuse, or use under abnormal conditions repairs are charged to the user. ADFweb.com S.r.l. will not be liable for accidental loss of use or inability to use this product, such as loss of business income. ADFweb.com S.r.l. shall not be liable for consequences of improper use.

OTHER REGULATIONS AND STANDARDS:**WEEE INFORMATION**

Disposal of old electrical and electronic equipment (as in the European Union and other European countries with separate collection systems).

— This symbol on the product or on its packaging indicates that this product may not be treated as household rubbish. Instead, it should be taken to an applicable collection point for the recycling of electrical and electronic equipment. If the product is disposed correctly, you will help prevent potential negative environmental factors and impact of human health, which could otherwise be caused by inappropriate disposal. The recycling of materials will help to conserve natural resources. For more information about recycling this product, please contact your local city office, your household waste disposal service or the shop where you purchased the product.

RESTRICTION OF HAZARDOUS SUBSTANCES DIRECTIVE

The device respects the 2002/95/EC Directive on the restriction of the use of certain hazardous substances in electrical and electronic equipment (commonly referred to as Restriction of Hazardous Substances Directive or RoHS).

CE MARKING

The product conforms with the essential requirements of the applicable EC directives.

WARRANTIES AND TECHNICAL SUPPORT:

For fast and easy technical support for your ADFweb.com SRL products, consult our internet support at www.adfweb.com. Otherwise contact us at the address support@adfweb.com

RETURN POLICY:

If while using your product you have any problem and you wish to exchange or repair it, please do the following:

- ➔ Obtain a Product Return Number (PRN) from our internet support at www.adfweb.com. Together with the request, you need to provide detailed information about the problem.
- ➔ Send the product to the address provided with the PRN, having prepaid the shipping costs (shipment costs billed to us will not be accepted).

If the product is within the warranty of twelve months, it will be repaired or exchanged and returned within three weeks. If the product is no longer under warranty, you will receive a repair estimate.



ADFweb.com S.r.l.
Via Strada Nuova, 17
IT-31010 Mareno di Piave
TREVISO (Italy)
Phone +39.0438.30.91.31
Fax +39.0438.49.20.99
www.adfweb.com

