

User Manual

Revision 1.003
English

NMEA2000 / Modbus Slave - Converter

(Order Code: HD67222-A1 – HD67222-B2)

for Website information:

www.adfweb.com?Product=HD67222-A1

www.adfweb.com?Product=HD67222-B2

for Price information:

www.adfweb.com?Price=HD67222-A1

www.adfweb.com?Price=HD67222-B2

Benefits and Main Features:

- ▶ Very easy to configure
- ▶ Low cost
- ▶ Modbus RTU on Serial RS232/485
- ▶ RS232/485 selection
- ▶ Galvanic isolation
- ▶ Industrial temperature range:
-40°C / 85°C (-40°F / 185°F)

Similar
Products
→

←
Benefit

INDEX:

	Page
INDEX	2
UPDATED DOCUMENTATION	2
REVISION LIST	2
WARNING	2
TRADEMARKS	2
SECURITY ALERT	3
CONNECTION SCHEME	4
CHARACTERISTICS	6
POWER SUPPLY	6
CONFIGURATION	7
USE OF COMPOSITOR SW67222	7
NEW PROJECT / OPEN PROJECT	8
SET COMMUNICATION	9
RECIVE NMEA	10
DEFINE RECEIVE NMEA	11
TRANSMIT NMEA	12
DEFINE TANSMIT NMEA	13
REMOTE REQUEST	14
UPDATE DEVICE	15
CHARACTERISTICS OF THE CABLES	16
MECHANICAL DIMENSIONS	16
ORDER CODE	17
ACCESSORIES	17
DISCLAIMER	18
OTHER REGULATIONS AND STANDARDS	18
WARRANTIES AND TECHNICAL SUPPORT	19
RETURN POLICY	19
PRODUCTS AND RELATED DOCUMENTS	19

UPDATED DOCUMENTATION:

Dear customer, we thank you for your attention and we remind you that you need to check that the following document is:

- Updated
- Related to the product you own

To obtain the most recently updated document, note the “document code” that appears at the top right-hand corner of each page of this document.

With this “Document Code” go to web page www.adfweb.com/download/ and search for the corresponding code on the page. Click on the proper “Document Code” and download the updates.

To obtain the updated documentation for the product that you own, note the “Document Code” (Abbreviated written "Doc. Code" on the label on the product) and download the updated from our web site www.adfweb.com/download/

REVISION LIST:

Revision	Date	Author	Chapter	Description
1.000	09/07/2010	Dp	All	First release version
1.001	23/07/2010	Dp	All	Revision
1.002	12/02/2013	Nt	All	Added new chapters
1.003	10/04/2014	Dp	All	Revision

WARNING:

ADFweb.com reserves the right to change information in this manual about our product without warning.
ADFweb.com is not responsible for any error this manual may contain.

TRADEMARKS:

All trademarks mentioned in this document belong to their respective owners.

SECURITY ALERT:**GENERAL INFORMATION**

To ensure safe operation, the device must be operated according to the instructions in the manual. When using the device are required for each individual application, legal and safety regulation. The same applies also when using accessories.

INTENDED USE

Machines and systems must be designed so the faulty conditions do not lead to a dangerous situation for the operator (i.e. independent limit switches, mechanical interlocks, etc.).

QUALIFIED PERSONNEL

The device can be used only by qualified personnel, strictly in accordance with the specifications.

Qualified personnel are persons who are familiar with the installation, assembly, commissioning and operation of this equipment and who have appropriate qualifications for their job.

RESIDUAL RISKS

The device is state of the art and is safe. The instrument can represent a potential hazard if they are inappropriately installed and operated by personnel untrained. These instructions refer to residual risks with the following symbol:

 This symbol indicates that non-observance of the safety instructions is danger for people to serious injury or death and / or the possibility of damage.

CE CONFORMITY

The declaration is made by us. You can send an email to or give us a call if you need it.

CONNECTION SCHEME:

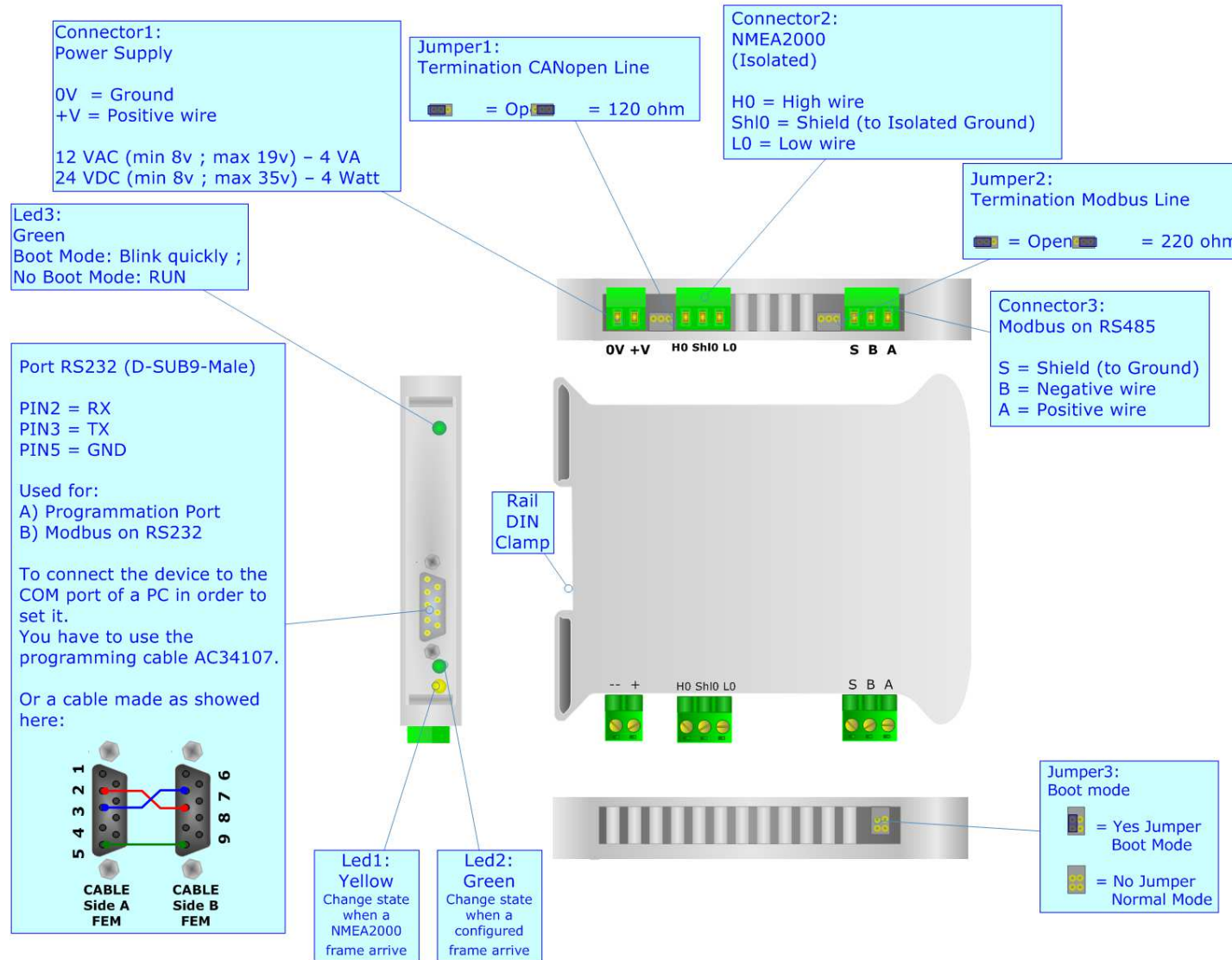

Figure 1: Connection scheme for HD67222-A1

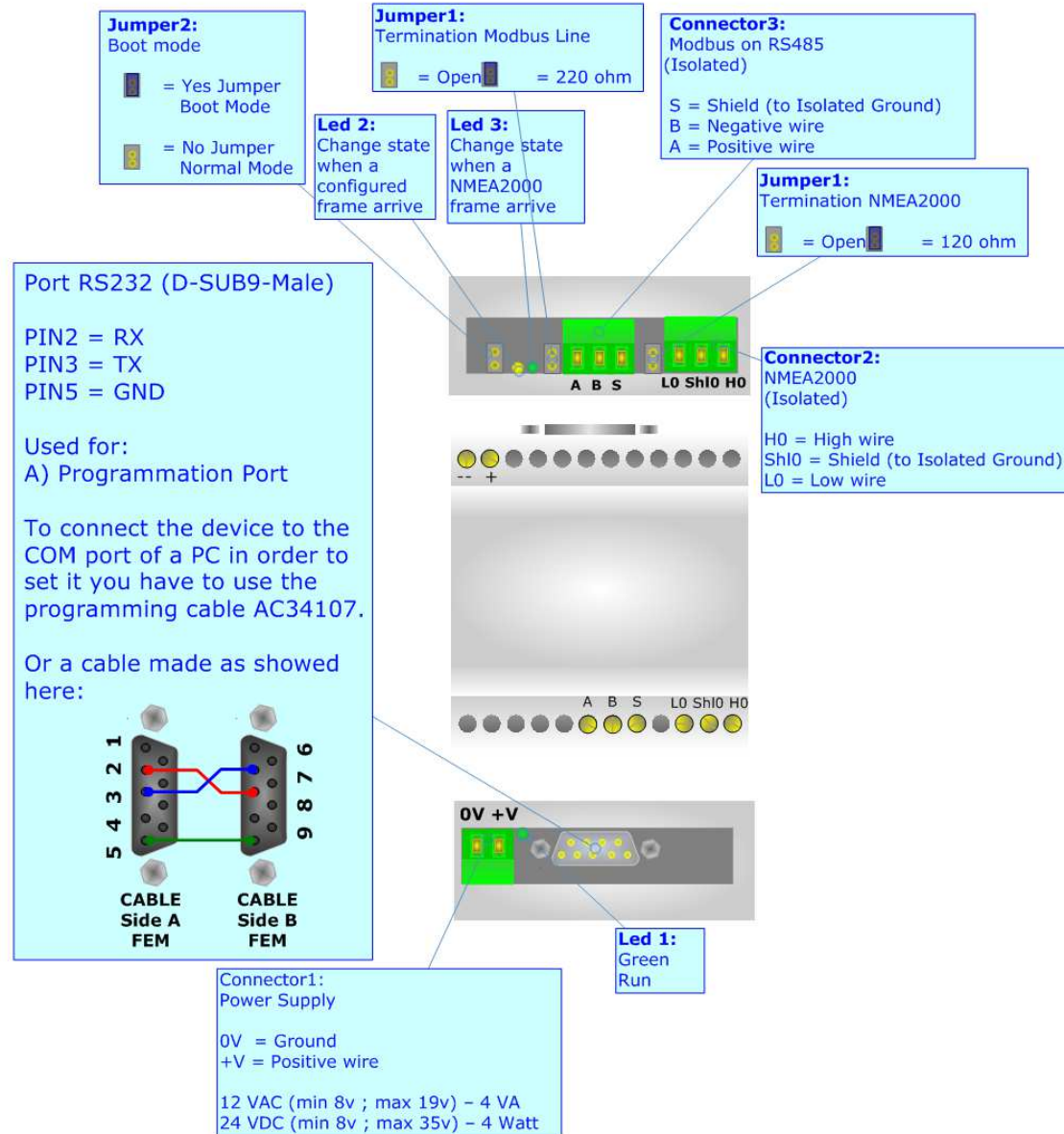

Figure 2: Connection scheme for HD67222-B2

CHARACTERISTICS:

The configurable NMEA 2000 into Modbus Slave gateway allow the following:

- Baud rate changeable with software;
- Mountable on Rail DIN;
- Temperature range from -40°C to 85°C.

POWER SUPPLY:

Recommended Power Supply	
VDC	VAC
24v	12v

VDC		VAC	
Vmin	Vmax	Vmin	Vmax
8v	35v	8v	19v

Caution: Not reverse the polarity power.

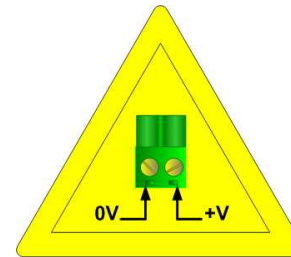

HD67222-A1

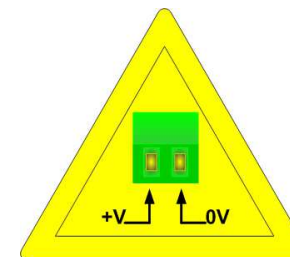

HD67222-B2

CONFIGURATION:

The “NMEA 2000 / Modbus Slave - Converter”, allows a NMEA 2000 network to communicate with a Modbus network.

You need Compositor SW67222 software on your PC in order to perform the following:

- Define which NMEA 2000 frames are reading from Modbus;
- Define which NMEA 2000 frames are writing from Modbus.

USE OF COMPOSITOR SW67222:

To configure the Gateway, use the available software that runs with Windows, called SW67222. It is downloadable on the site www.adfweb.com and its operation is described in this document.

When launching the SW67222 the right window appears (Fig. 2).

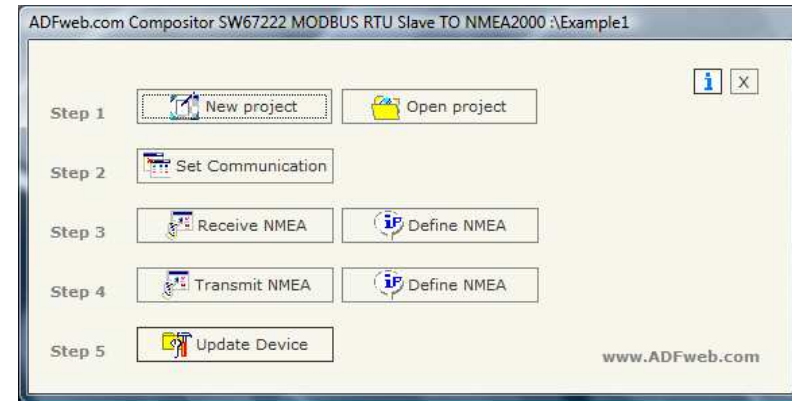

Figure 3: Main window for SW67222

NEW PROJECT / OPEN PROJECT:

The “New Project” button creates the folder which contains the entire device configuration.
A device configuration can also be imported and exported:

- To clone the configurations of a Programmable NMEA 2000 to Modbus Gateway in order to configure another device in the same manner, it is necessary to maintain the folder and all its contents;
- To clone a project in order to obtain a different version of the project, it is sufficient to duplicate the project folder with another name and open the new folder with the button “Open Project”;

When a new project is created or an existent project is open, it will be possible to access the various configuration section of the software:

- **Set Communication;**
- **Receive NMEA;**
- **Define NMEA;**
- **Transmit NMEA;**
- **Define NMEA.**

GENERAL PARAMETER:

This section defines the fundamental communication parameters of two Buses, NMEA 2000 and Modbus.

By pressing the "Set communication" button from the main window for SW67222 (Fig. 3) the window "Set Communication" appears (Fig. 4):

- In the fields "Baud Rate" the velocity of the two buses are defined;
- In the field "TimeOut Data" insert a time, when this time is elapsed the data isn't reliable, and in the Modbus register you can read "FFFF";
- The field "Modbus register" insert a number of register, in this register you can visualize if the data is reliable, if 1 the data is ok, if 0 the data is oldest of the time inserted in the time out data;
- If the field "Peer to Peer" is checked the gateway accept any source address that have the PGN inserted in the section "Receive NMEA";
- If the field "Enable write NMEA on request" is checked, the field "Write NMEA 2000 frame" in "Transmit NMEA 2000 frame info" is enabled. If this field is not checked, the device send a NMEA 2000 frame for every written register. Otherwise it is possible to select when to send the NMEA 2000 frame;
- If "Send frame every xx ms" is checked the gateway sends the NMEA 2000 frames defined in "Transmit NMEA" section every xx ms. Otherwise a frame is sent in NMEA 2000 when a modbus register is written into the gateway;
- If the field "Enable Remote Request" is checked it is possible to use the "Remote Request". To use this, is necessary to insert in the four fields under the four Modbus Registers.
- In the field "parity", the serial parity is defined;
- The Gateway has two alternative outlets from the Modbus side: RS485 or RS232. Select the desired choice;
- In the field "Dev ID" the Modbus address is defined;
- In the section Hardware, the type of hardware is selected. For more info about your hardware see the connection scheme at page 3 (HD67222-A1) and 4 (HD67222-B2).

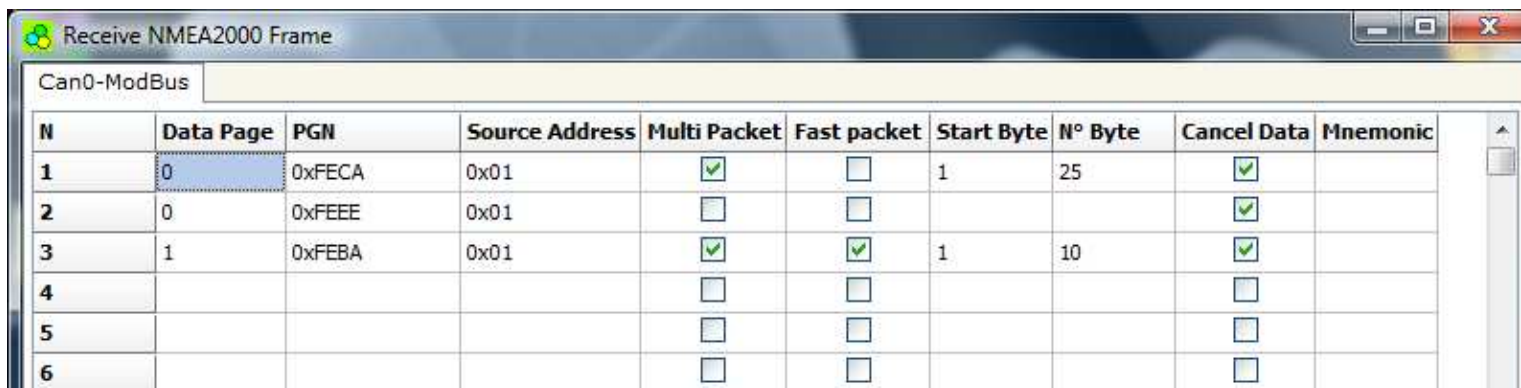

Figure 4: "Set Communication" window

RECEIVE NMEA:

N	Data Page	PGN	Source Address	Multi Packet	Fast packet	Start Byte	N° Byte	Cancel Data	Mnemonic
1	0	0xFECA	0x01	<input checked="" type="checkbox"/>	<input type="checkbox"/>	1	25	<input checked="" type="checkbox"/>	
2	0	0xFEEE	0x01	<input type="checkbox"/>	<input type="checkbox"/>			<input checked="" type="checkbox"/>	
3	1	0xFEBA	0x01	<input checked="" type="checkbox"/>	<input checked="" type="checkbox"/>	1	10	<input checked="" type="checkbox"/>	
4				<input type="checkbox"/>	<input type="checkbox"/>			<input type="checkbox"/>	
5				<input type="checkbox"/>	<input type="checkbox"/>			<input type="checkbox"/>	
6				<input type="checkbox"/>	<input type="checkbox"/>			<input type="checkbox"/>	

Figure 5: "Receive NMEA2000 frame" window

By pressing the "Receive NMEA" button from the main window for SW67222 (Fig. 3) the window "Receive NMEA 2000 frame" appears (Fig. 5):

The means of the fields of the table are:

- In the field "Data Page" insert the data page, the value is 0 or 1 (usually is 0)
- In the field "PGN" insert the PGN of the data you would to read from modbus to NMEA 2000. (in the NMEA 2000 protocol the PGN is an identifier);
- In the field "Source Address" insert the address of the device that send the frame.
- If the field "Multi Packet" is checked the frame could use transporrt protocol functions;
- If the field "Fast Packet" is checked the frame could use the Fast Packet Protocol functions;
- In the field "StartByte" insert the byte which you would start read, this field is enable only when the field multi frame or fast packet is checked;
- In the field "N° Byte" insert the number of byte you would read, for example your start byte is 20 an N°byte is 10, you can read the byte from 20 to 30.
- If the field "Cancel Data" is checked and the Modbus Register in the section "set communication" is 0 the gateway when the data is oldest of the time inserted in the "time out data" you visualize "FFFF" in the Modbus registers of this PGN.
- In the field "Mnemonic" the description for the frame is defined.

DEFINE RECEIVE NMEA

By pressing the "Define NMEA" button from the main window for SW67222 (Fig. 3) the window "Receive NMEA 2000 frame info" appears (Fig. 6):

- In the field "PGN" there are PGN who you insert in the list;
- In the field "MODBUS" there are the modbus words;
- In the field "Index MODBUS" there is the address who contain the Modbus word;
- In the field "Selecet Frame Byte" you select the position of the byte.

For example:

Click on the PGN, insert the valid address in the field Index MODBUS, select the byte position(B1 in high MODBUS byte and B2 in low MODBUS byte), click the "New" button, in the field MODBUS appears the names of modbus words (The fist word is name IND MB 0, second IND MB 1, third Ind MB 2 and so on).

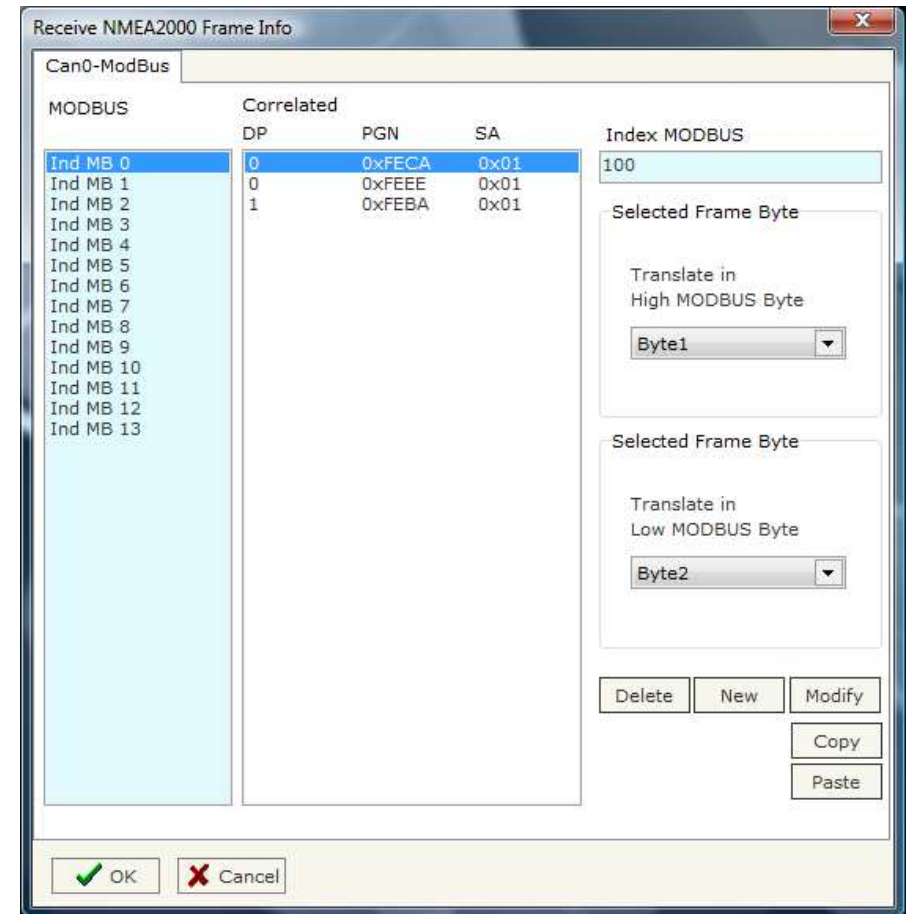

Figure 6: "Receive NMEA2000 frame info" window

TRANSMIT NMEA

By pressing the "Transmit NMEA" button from the main window of SW67222 the window "Transmit NMEA 2000 frame" appears (Fig. 7):

In the right scenario:

- In the field "Priority" insert the priority of the frame, in NMEA 2000 protocol is a number among 0,1,2,3,4,5,6,7. The number 0 is the highest priority and 7 is the lowest;
- In the field "Data Page" insert the data page, in the NMEA 2000 protocol is 0 or 1;
- In the field "PGN" insert the PGN of the data you would to write from modbus to NMEA 2000. (in the NMEA 2000 protocol the PGN is an identifier);
- In the field "ID device" you insert the ID of device that send the frame.

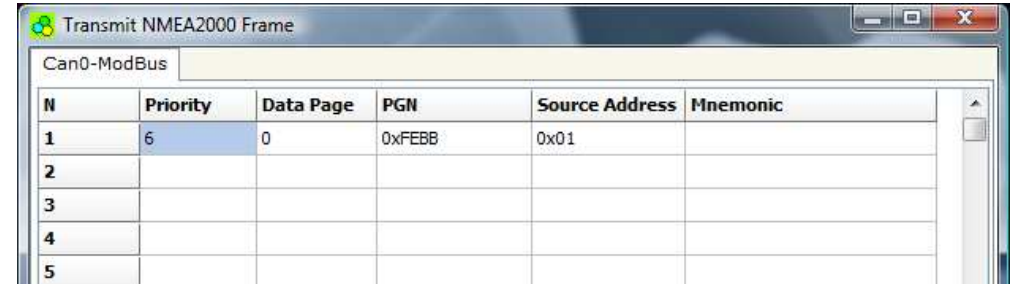

Figure 7: "Transmit NMEA2000 frame" window

DEFINE TRNASMIT NMEA

By pressing the "Define NMEA" button from the main window for SW67222 (Fig. 3) the window "Transmit NMEA 2000 Frame Info" appears (Fig. 8):

- In the field "PGN" there are PGN who you insert in the list of transmit NMEA;
- In the field "MODBUS" there are the modbus words.
- In the field "Index MODBUS" there is the address who contain the Modbus word;
- In the field "Selecet Frame Byte" you select the position of the byte;
- With the field "Write NMEA 2000 Frame" it is possible to decide when to send the NMEA 2000 frame. If a modbus register has setted "True" in this field and it is written the frame NMEA 2000 will be sent, otherwise if is setted to False the NMEA 2000 frame will not be sent. It is possible to have this function only if the field "Enable write NMEA on request" in the "Set Communication" window is checked.

For example:

Click on the PGN, insert the valid address in the field Index MODBUS, select the byte position(B1 in high MODBUS byte and B2 in low MODBUS byte), click the "New" button, in the field MODBUS appears the names of modbus words (The fist word is name IND MB 0, second IND MB 1, third Ind MB 2 and so on).

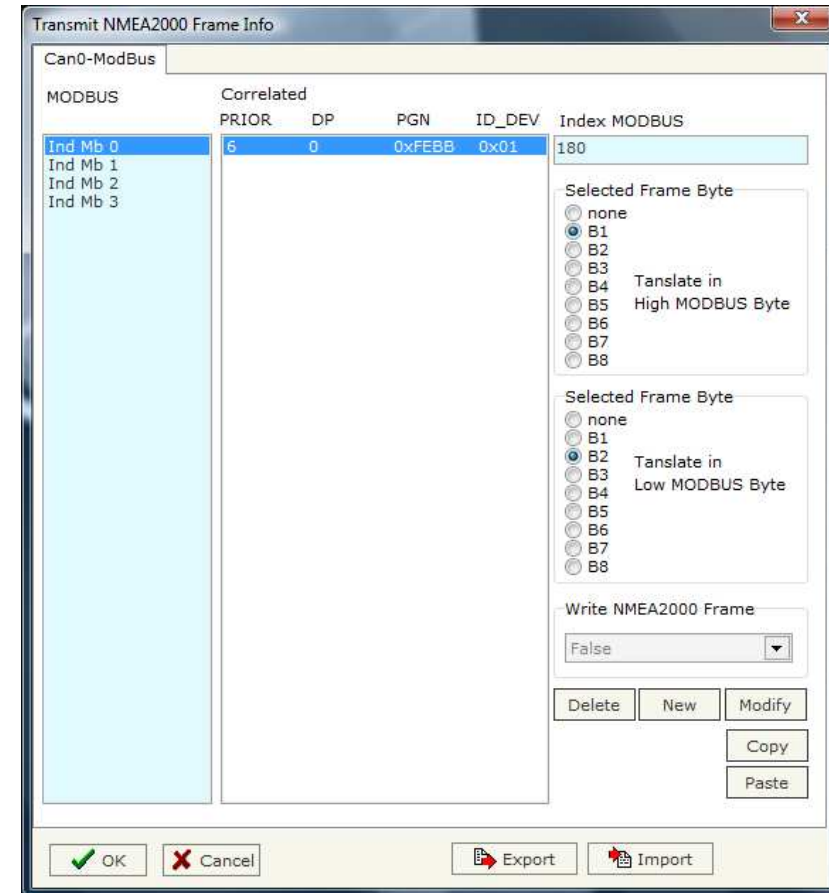

Figure 8: "Transmit NMEA2000 frame info" window

REMOTE REQUEST

In the "Priority and Destination" Register you have to indicate the Priority of the request in the high byte of the register (usually this value is equal to 6) and the Address of the Destination Device in the low byte of register.

In the "PGN Part 1" you have to indicate the first two byte of the PGN while in the "PGN Part 2" Register you have to indicate, in the high byte of register, the third byte of the PGN.

In the "Source Address" Register you have to indicate the Source Address of the request in the high part of the register.

Only when you write the "Source Address" register the request will be send to the NMEA 2000 network.

For example if you want to request the PGN 0x00FEE5 at device with address 5 you have to write:

1st reg = 0x0605

2nd reg = 0xE5FE

3rd reg = 0x0000

4th reg = 0x0100

UPDATE DEVICE:

Section "Update device Serial" (Fig. 9):

In order to load the parameters or update the firmware in the gateway, follow these instructions:

- Turn off the Device;
- Connect the Null Modem Cable Form your PC to the Gateway;
- Insert the Boot Jumper (see the Fig. 1 for more info);
- Select COM port and press the "Connect" Button;
- Turn on the device;
- Press the "Next" Button;
- Select which operations you want to do. Can select only Firmware or only Project or both;
- Press the "Execute update firmware" to start the upload;
- When all the operation are "OK" turn off the device;
- Disconnect the Boot jumper;
- Disconnect the RS232 Cable;
- Turn on the device.

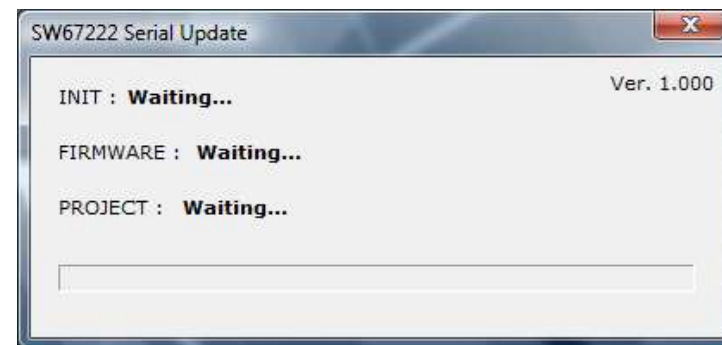
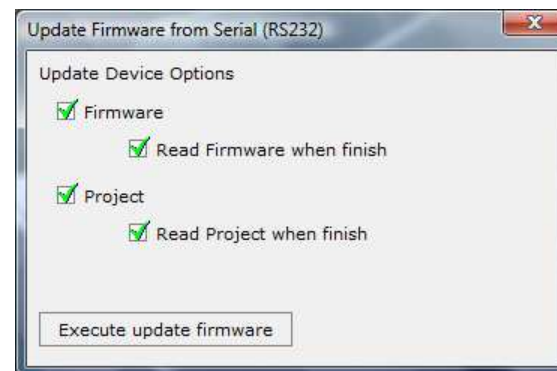

Figure 9: Update device procedure

CHARACTERISTICS OF THE CABLES:

The connection from RS232 socket to a serial port (example one from a personal computer), must be made with a Null Modem cable (a serial cable where the pins 2 and 3 are crossed).
It is recommended that the RS232C Cable not exceed 15 meters.

MECHANICAL DIMENSIONS:

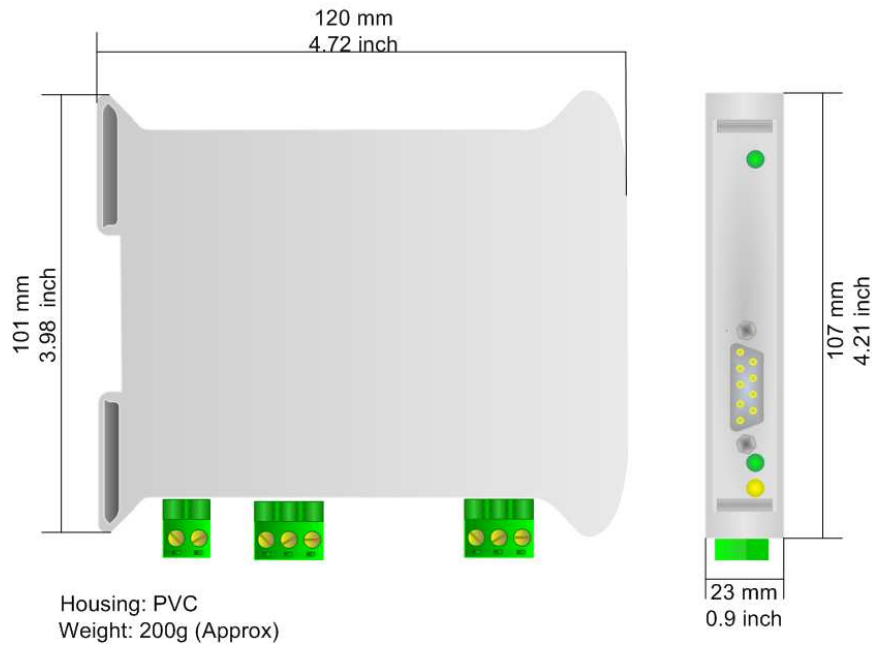

Figure 10: Mechanical dimensions scheme for HD67222-A1

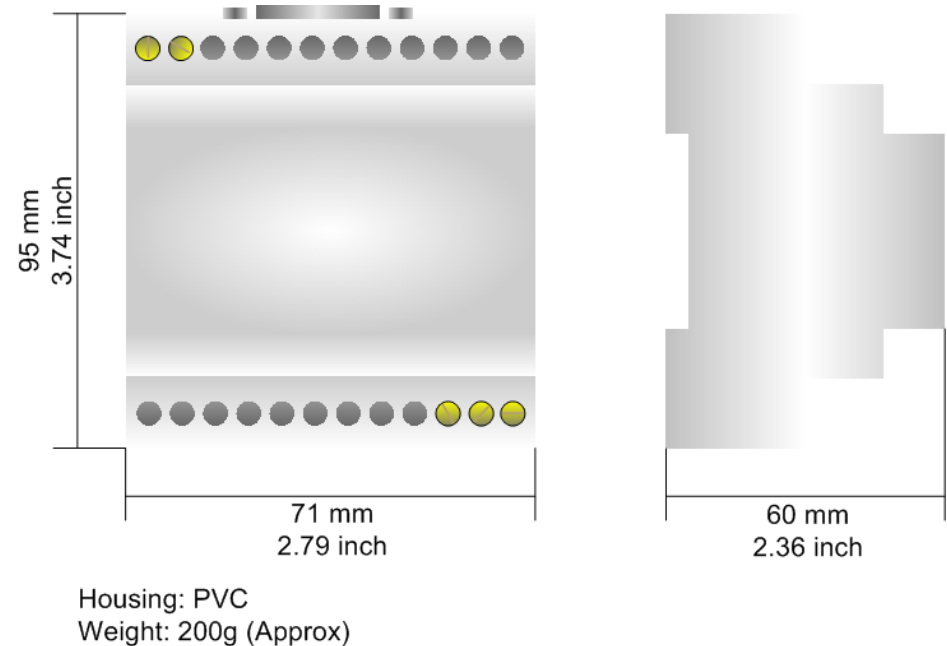

Figure 11: Mechanical dimensions scheme for HD67222-B2

ORDER CODES:

Order Code: **HD67222-A1** - NMEA 2000 / Modbus Slave - Converter

Order Code: **HD67222-B2** - NMEA 2000 / Modbus Slave - Converter

ACCESSORIES:

Order Code: **AC34107** - Null Modem Cable Fem/Fem DSub 9 Pin 1,5 m

Order Code: **AC34114** - Null Modem Cable Fem/Fem DSub 9 Pin 5 m

Order Code: **AC34001** - Rail DIN - Power Supply 220/240V AC 50/60Hz - 12 V AC

Order Code: **AC34002** - Rail DIN - Power Supply 110V AC 50/60Hz - 12 V AC

DISCLAIMER

All technical content within this document can be modified without notice. The content of the document content is a recurring audit. For losses due to fire, earthquake, third party access or other accidents, or intentional or accidental abuse, misuse, or use under abnormal conditions repairs are charged to the user. ADFweb.com S.r.l. will not be liable for accidental loss of use or inability to use this product, such as loss of business income. ADFweb.com S.r.l. shall not be liable for consequences of improper use.

OTHER REGULATIONS AND STANDARDS

WEEE INFORMATION



Disposal of old electrical and electronic equipment (as in the European Union and other European countries with separate collection systems).

— This symbol on the product or on its packaging indicates that this product may not be treated as household rubbish. Instead, it should be taken to an applicable collection point for the recycling of electrical and electronic equipment. If the product is disposed correctly, you will help prevent potential negative environmental factors and human health, which could otherwise be caused by inappropriate disposal. The recycling of materials will help to conserve natural resources. For more information about recycling this product, please contact your local city office, your household waste disposal service or the shop where you purchased the product.

RESTRICTION OF HAZARDOUS SUBSTANCES DIRECTIVE



The device respects the 2002/95/EC Directive on the restriction of the use of certain hazardous substances in electrical and electronic equipment (commonly referred to as Restriction of Hazardous Substances Directive or RoHS).

CE MARKING



The product conforms with the essential requirements of the applicable EC directives.

WARRANTIES AND TECHNICAL SUPPORT:

For fast and easy technical support for your ADFweb.com SRL products, consult our internet support at www.adfweb.com.

Otherwise contact us at the address support@adfweb.com

RETURN POLICY:

If while using your product you have any problem and you wish to exchange or repair it, please do the following:

- 1) Obtain a Product Return Number (PRN) from our internet support at www.adfweb.com. Together with the request, you need to provide detailed information about the problem.
- 2) Send the product to the address provided with the PRN, having prepaid the shipping costs (shipment costs billed to us will not be accepted).

If the product is within the warranty of twelve months, it will be repaired or exchanged and returned within three weeks.

If the product is no longer under warranty, you will receive a repair estimate.

PRODUCTS AND RELATED DOCUMENTS:

Part	Description	URL
HD67121	Gateway CANopen / Canopen	www.adfweb.com?product=HD67121
HD67002	Gateway CANopen / Modbus - RTU	www.adfweb.com?product=HD67002
HD67004 HD67005	Gateway CANopen / Modbus - Ethernet TCP	www.adfweb.com?product=HD67004
HD67134	Gateway CANopen / DeviceNet	www.adfweb.com?product=HD67134
HD67117	CAN bus Repeater	www.adfweb.com?product=HD67117
HD67216	CAN bus Analyzer	www.adfweb.com?product=HD67216