

User Manual

Revision 1.001
English

PROFINET / NMEA 2000 – Converter

(Order Code: HD67600-A1)

For Website information:



INDEX:

	Page
INDEX	2
UPDATED DOCUMENTATION	2
REVISION LIST	2
WARNING	2
TRADEMARKS	2
SECURITY ALERT	3
EXAMPLE OF CONNECTION	4
CONNECTION SCHEME	5
CHARACTERISTICS	6
CONFIGURATION	6
POWER SUPPLY	7
FUNCTION MODES	8
LEDS	9
PROFINET	10
NMEA 2000	11
USE OF COMPOSITOR SW67600	12
NEW CONFIGURATION / OPEN CONFIGURATION	13
SOFTWARE OPTIONS	14
SET COMMUNICATION	15
RECEIVE NMEA	16
SEND NMEA	17
UPDATE DEVICE	18
MECHANICAL DIMENSIONS	21
ORDERING INFORMATIONS	22
ACCESSORIES	22
PLC CONFIGURATION	23
DISCLAIMER	28
OTHER REGULATIONS AND STANDARDS	28
WARRANTIES AND TECHNICAL SUPPORT	29
RETURN POLICY	29

UPDATED DOCUMENTATION:

Dear customer, we thank you for your attention and we remind you that you need to check that the following document is:

- ✚ Updated
- ✚ Related to the product you own

To obtain the most recently updated document, note the “document code” that appears at the top right-hand corner of each page of this document.

With this “Document Code” go to web page www.adfweb.com/download/ and search for the corresponding code on the page. Click on the proper “Document Code” and download the updates.

REVISION LIST:

Revision	Date	Author	Chapter	Description
1.000	28/09/2012	Dp	All	First Release
1.001	13/02/2014	Fl	All	Revision

WARNING:

ADFweb.com reserves the right to change information in this manual about our product without warning.
ADFweb.com is not responsible for any error this manual may contain.

TRADEMARKS:

All trademarks mentioned in this document belong to their respective owners.

SECURITY ALERT:**GENERAL INFORMATION**

To ensure safe operation, the device must be operated according to the instructions in the manual. When using the device, legal and safety regulation are required for each individual application. The same applies also when using accessories.

INTENDED USE

Machines and systems must be designed so the faulty conditions do not lead to a dangerous situation for the operator (i.e. independent limit switches, mechanical interlocks, etc.).

QUALIFIED PERSONNEL

The device can be used only by qualified personnel, strictly in accordance with the specifications. Qualified personnel are persons who are familiar with the installation, assembly, commissioning and operation of this equipment and who have appropriate qualifications for their job.

RESIDUAL RISKS

The device is state-of-the-art and is safe. The instruments can represent a potential hazard if they are inappropriately installed and operated by untrained personnel. These instructions refer to residual risks with the following symbol:



This symbol indicates that non-observance of the safety instructions is a danger for people that could lead to serious injury or death and / or the possibility of damage.

CE CONFORMITY

The declaration is made by our company. You can send an email to or give us a call if you need it.

EXAMPLES OF CONNECTION:

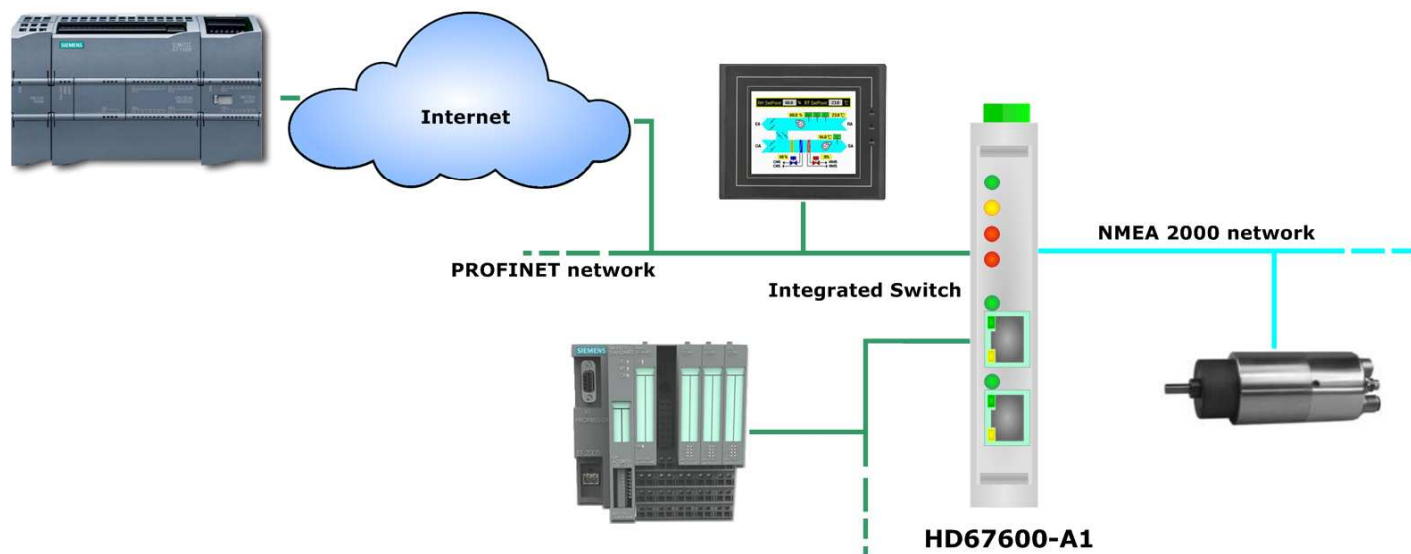
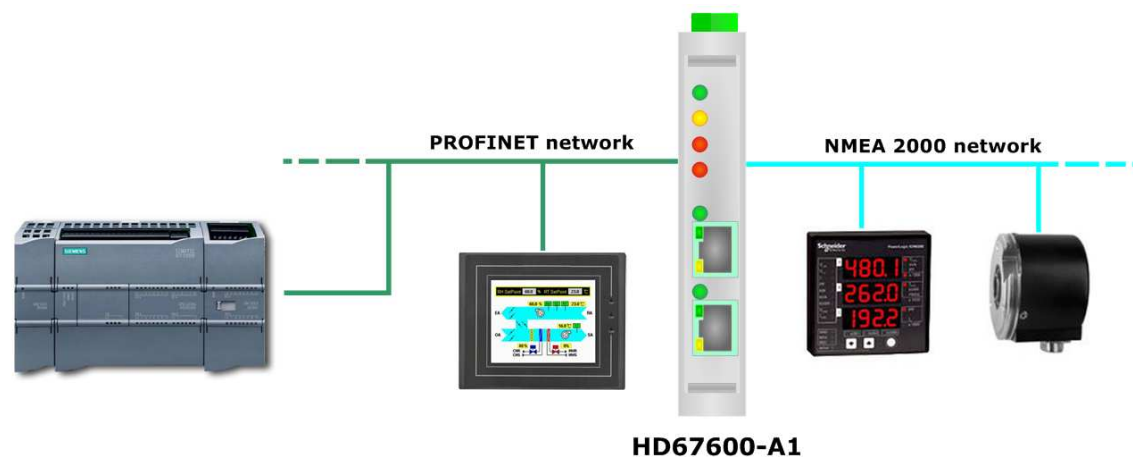

CONNECTION SCHEME:

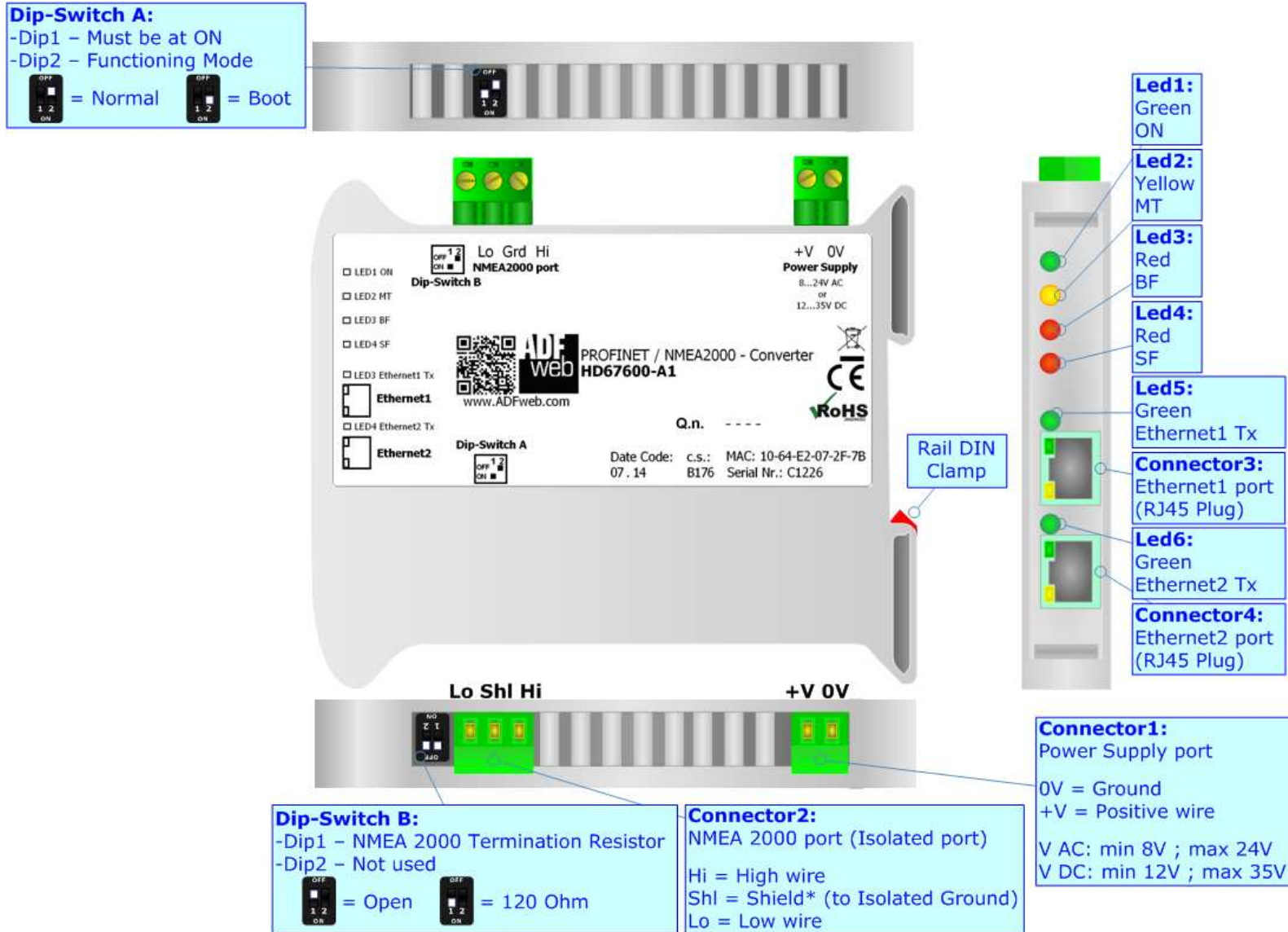

Figure 1: Connection scheme for HD67600-A1

CHARACTERISTICS:

The HD67600-A1 is a PROFINET / NMEA 2000 - Converter.

It allows for the following characteristics:

- Up to 512 bytes in reading and 512 bytes in writing;
- Triple isolation between CAN - Power Supply, CAN - Ethernet, Power Supply - Ethernet.
- Two-directional information between NMEA 2000 bus and PROFINET bus;
- Mountable on 35mm Rail DIN;
- Wide power supply input range: 8...24V AC or 12...35V DC;
- Wide temperature range: -40°C / 85°C [-40°F / +185°F].

**Note:**

The number of Input / Output used by the Converter is calculated automatically according to the NMEA 2000 frames defined in section "Receive NMEA 2000" and "Send NMEA 2000".



CONFIGURATION:

You need Compositor SW67600 software on your PC in order to perform the following:

- Define the parameter of PROFINET line;
- Define the parameter of NMEA 2000 line;
- Define the NMEA 2000 frames that the Converter can accept;
- Define the NMEA 2000 frames that the Converter sends through the NMEA 2000 line;
- Update the device.

POWER SUPPLY:

The device can be powered at 8...24V AC and 12...35V DC. For more details see the two tables below.

VAC 		VDC 	
Vmin	Vmax	Vmin	Vmax
8V	24V	12V	35V

Consumption at 24V DC:

Device	Consumption [W/VA]
HD67600-A1	3.5

 **Caution: Not reverse the polarity power**

Connector1:
 Power Supply port
 0V = Ground
 +V = Positive wire
 V AC: min 8V ; max 24V
 V DC: min 12V ; max 35V

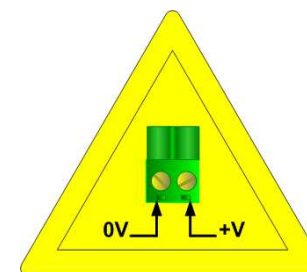
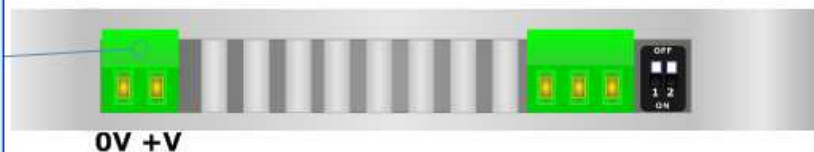

HD67600-A1

FUNCTION MODES:

The device has got two function modes depending on the position of the 'Dip2 of Dip-Switch A':

- The first, with 'Dip2 of Dip-Switch A' at "OFF" position, is used for the normal working of the device.
- The second, with 'Dip2 of Dip-Switch A' at "ON" position, is used for uploading the Project and/or Firmware.

For the operations to follow for the updating, see 'UPDATE DEVICE' section.

According to the functioning mode, the LEDs will have specific functions, see 'LEDS' section.

**Warning:**

Dip1 of 'Dip-Switch A' must be at ON position to work even if the Ethernet cable is not inserted.

LEDS:

The device has got six LEDs that are used to give information of the functioning status. The various meanings of the LEDs are described in the table below.

LED	Normal Mode	Boot Mode
1: ON [supply voltage] (green)	ON: Device powered OFF: Device not powered	ON: Device powered OFF: Device not powered
2: MT [maintenance display] (yellow)	ON: Maintenance Problem is present OFF: No maintenance are present	Blinks quickly: Boot state Blinks very slowly (~0.5Hz): update in progress
3: BF [bus fault] (red)	ON: The Ethernet connection is defective; the IP address exists several times in the network; the own NameOfStation exists several times in the network; no IP address has been set Flashing: At least one configured AR is no longer in the data exchange OFF: No errors are present	Blinks quickly: Boot state Blinks very slowly (~0.5Hz): update in progress
4: SF [group error] (red)	ON: At least one AR is not in the data exchange OFF: No errors are present	Blinks quickly: Boot state Blinks very slowly (~0.5Hz): update in progress
5: Ethernet1 Tx (green)	Blinks when is transmitting Ethernet frames	Blinks quickly: Boot state Blinks very slowly (~0.5Hz): update in progress
6: Ethernet2 Tx (green)	Blinks when is transmitting Ethernet frames	Blinks quickly: Boot state Blinks very slowly (~0.5Hz): update in progress

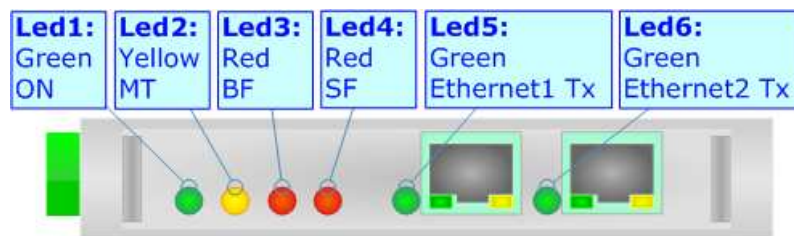

PROFINET:

The Ethernet connection must be made using Connector3 or Connector4 of HD67600-A1 with at least a Category 5E cable. The maximum length of the cable should not exceed 100m. The cable has to conform to the T568 norms relative to connections in cat.5 up to 100 Mbps. To connect the device to a Hub/Switch the use of a straight cable is recommended. To connect the device to a PC/PLC/other the use of a cross cable is recommended.

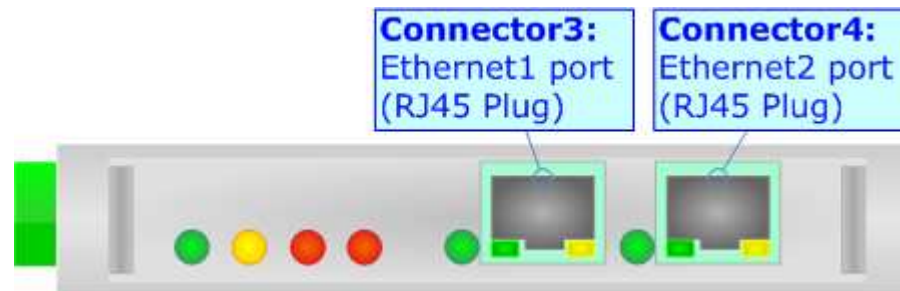

NMEA 2000:

For terminate the NMEA 2000 line with a 120Ω resistor it is necessary that the Dip1 of 'Dip-Switch B' is at ON position.

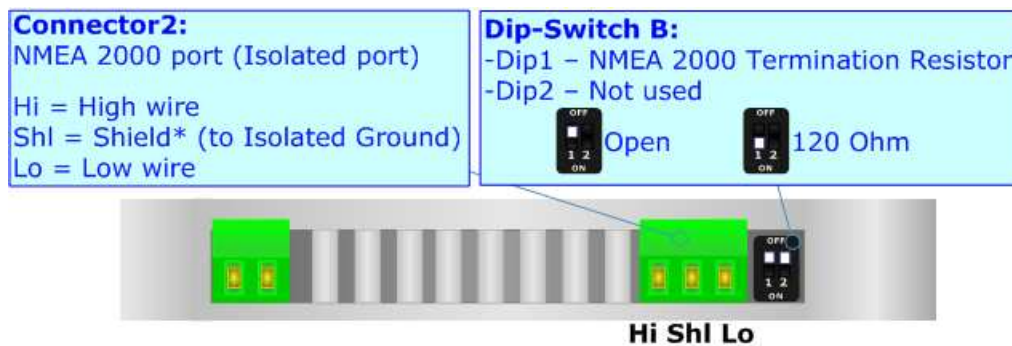

Cable characteristics:

DC parameter:	Impedance	70 Ohm/m
AC parameters:	Impedance	120 Ohm/m
	Delay	5 ns/m
Length	Baud Rate [bps]	Length MAX [m]
	10 K	5000
	20 K	2500
	50 K	1000
	100 K	650
	125 K	500
	250 K	250
	500 K	100
	800 K	50
	1000 K	25

USE OF COMPOSITOR SW67510:

To configure the Converter, use the available software that runs with Windows called SW67600. It is downloadable on the site www.adfweb.com and its operation is described in this document. *(This manual is referenced to the last version of the software present on our web site).* The software works with MSWindows (XP, Vista, Seven, 8; 32/64bit).

When launching the SW67600, the window on the right appears (Fig. 2).



Note:

It is necessary to have installed .Net Framework 4.

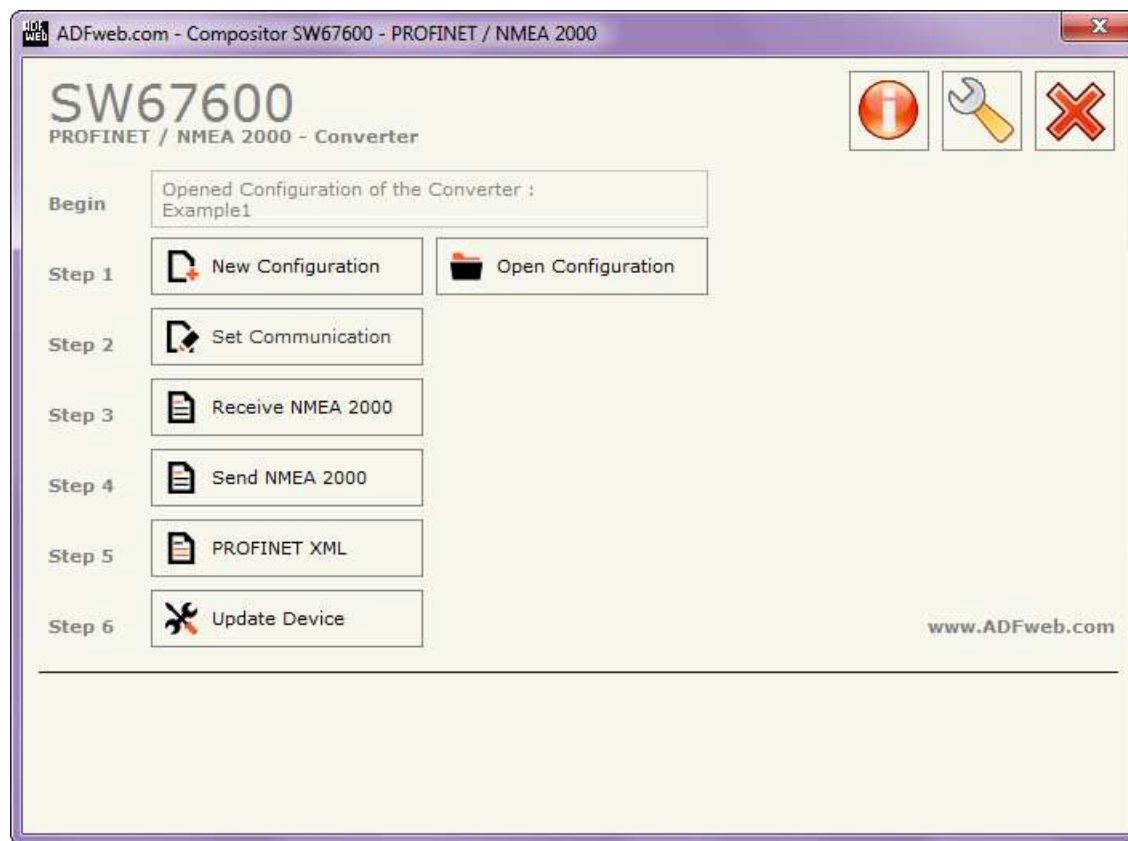

Figure 2: Main window for SW67600

NEW CONFIGURATION / OPEN CONFIGURATION:

The **“New Configuration”** button creates the folder which contains the entire device’s configuration.



A device’s configuration can also be imported or exported:

- To clone the configurations of a Programmable “PROFINET / NMEA 2000 - Converter” in order to configure another device in the same manner, it is necessary to maintain the folder and all its contents;
- To clone a project in order to obtain a different version of the project, it is sufficient to duplicate the project folder with another name and open the new folder with the button **“Open Configuration”**.

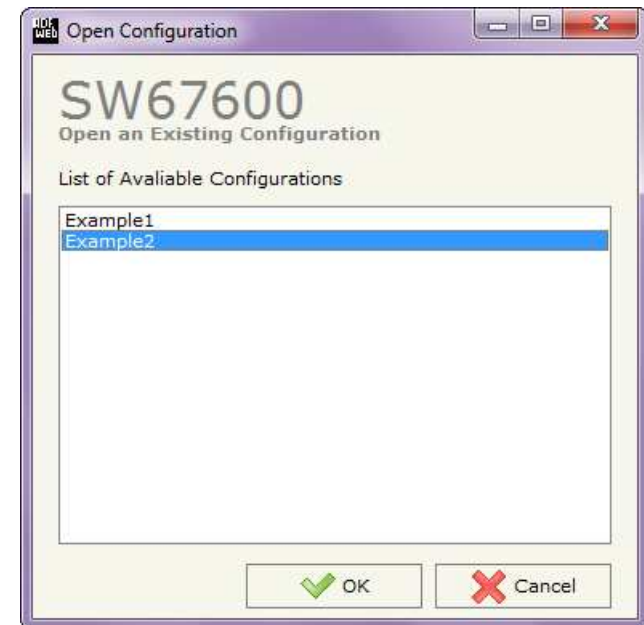

SOFTWARE OPTIONS:

By pressing the “**Settings**” () button there is the possibility to change the language of the software and check the updatings for the compositor.

In the section “Language” it is possible to change the language of the software.

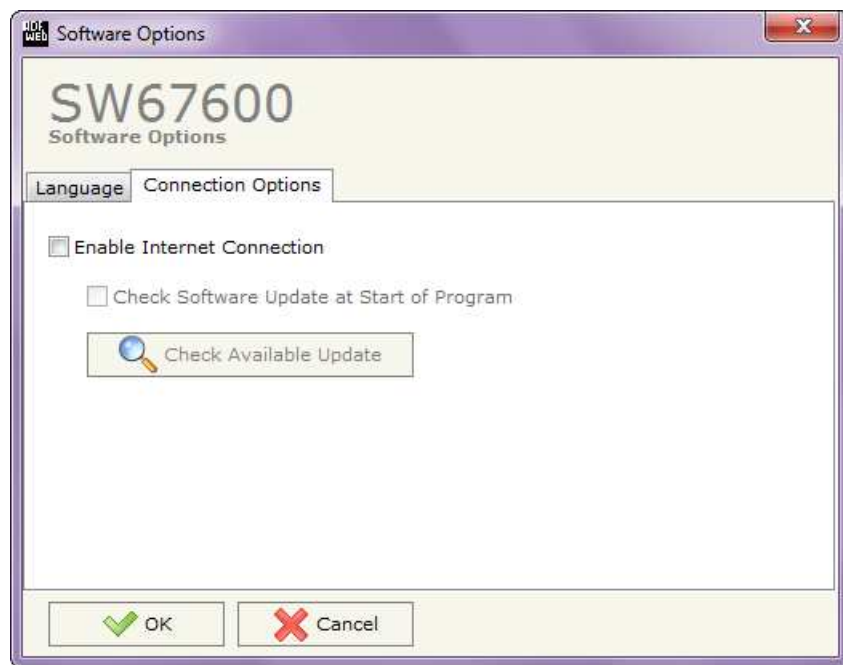

In the section “Connection Options”, it is possible to check if there are some updatings of the software compositor in ADFweb.com website. Checking the option “**Check Software Update at Start of Program**”, the SW67600 check automatically if there are updatings when it is launched.

SET COMMUNICATION:

This section define the fundamental communication parameters of two buses, PROFINET and NMEA 2000.

By Pressing the "**Set Communication**" button from the main window for SW67600 (Fig. 2) the window "Set Communication" appears (Fig. 3).

The window is divided in two sections, one for the PROFINET and the other for the NMEA 2000.

The means for the fields of "PROFINET" are:

- In the fields "**IP ADDRESS**" insert the IP address that you want to give to the Converter;
- In the fields "**SUBNET Mask**" insert the SubNet Mask;
- In the fields "**GATEWAY**" insert the default gateway that you want to use. This feature can be enabled or disabled pressing the Check Box field. This feature is used for going out of the net;
- In the field "**Port**" the port used for PROFINET communication is defined. The port has a fixed value of 34964;
- In the field "**PROFINET Name of Station**" is possible to assign a name to the PROFINET node.

The means of the fields for the "NMEA 2000" section are:

- In the "**Baudrate**" field the NMEA 2000 baudrate is defined;
- In the field "**TimeOut Data**" insert a time; when this time is elapsed and the data isn't reliable, in the PROFINET data array you read "0". It is possible to use this function only for the "Receive Frames";
- If the field "**Enable Peer to Peer**" is checked, the Converter accepts all the ID that have the PGN inserted in the "Receive Frames" section.

The screenshot shows a software window titled "Set Communication" for device "SW67600". It is divided into two main sections: "PROFINET" and "NMEA 2000".

PROFINET Section:

- IP ADDRESS:** 192 . 168 . 0 . 10
- SUBNET Mask:** 255 . 255 . 255 . 0
- GATEWAY:** GATEWAY, 192 . 168 . 0 . 1
- Port:** 34964
- PROFINET Name of Station:** devicename1

NMEA 2000 Section:

- Baudrate:** 250K
- Time Out Data (s):** 0
- Enable Peer to Peer:**

At the bottom, there are "OK" and "Cancel" buttons.

Figure 3: "Set Communication" window

RECEIVE FRAMES:

By pressing the "Receive NMEA" button from the main window for SW67600 (Fig. 2) the "Receive NMEA 2000 Frames" window appears (Fig. 4).

The NMEA 2000 frames inserted in this table contains the Output data of PROFINET. These frames are accepted by the Converter.

The data of the columns have the following meanings:

- In the field "PGN" insert the PGN of the data you would like to read from PROFINET to NMEA 2000 (it is an identifier);
- In the field "Source Address" insert the address of the device that sends the frame;
- If the field "Transport Protocol" is checked the frame use transport protocol functions;
- If the field "Fast Packet" is checked the frame use the fast packet protocol;
- In the field "Start Byte" insert the byte which you would start read, this field is enable only when the field Transport Protocol and/or Fast Packet are checked;
- In the field "N° Byte" insert the number of byte you would read, for example your start byte is 20 an N°byte is 10, you can read the byte from 20 to 30;
- If the field "Cancel Data" is checked, the data in the frame will be erased after the expiration of the "TimeOut Data" defined in "Set Communication" section;
- In the field "Mnemonic" it is possible to insert a brief description.

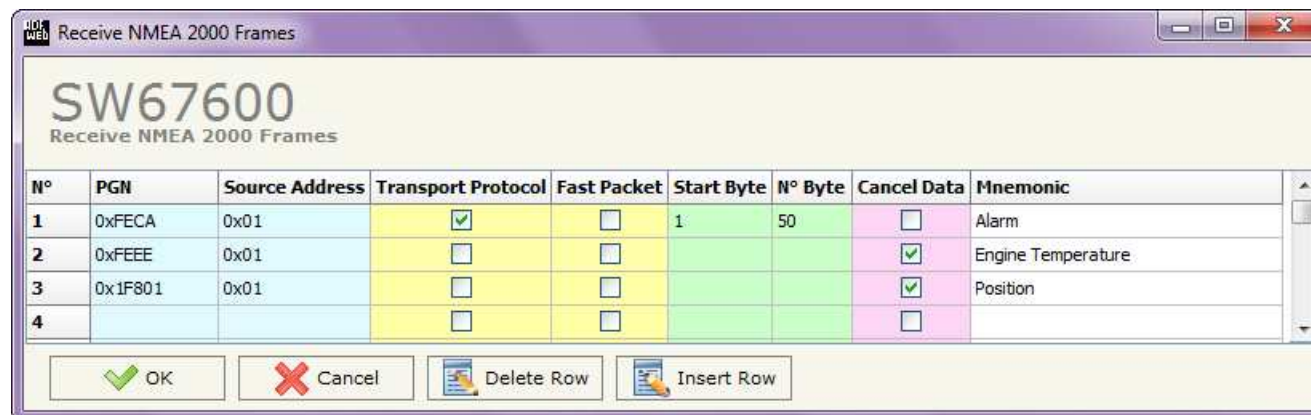

Figure 4: "Receive NMEA 2000 Frames" window



Note:

It is possible to configure a maximum of 62 frames in the "Receive NMEA 2000 Frames" section.

SEND FRAMES:

By pressing the "Send NMEA" button from the main window for SW67600 (Fig. 2) the "Send NMEA 2000 frames" window appears (Fig. 5).

The NMEA 2000 frames inserted in this table contains the Input data of PROFINET. These frames are sent by the Converter.

The data of the columns have the following meanings:

- In the field "Priority" insert the priority of the Frame: in NMEA 2000 protocol it is a number among 0,1,2,3,4,5,6,7. The number "0" is the highest priority and "7" is the lowest;
- In the field "PGN" insert the PGN of the data you would like to write from PROFINET to NMEA 2000 (in NMEA 2000 protocol the PGN is an identifier);
- In the field "Source Address" insert the address of the device that sends the frame;
- If the field "Fast Packet" is checked the frame use the Fast Packet Protocol;
- In the field "Num Byte" the number of byte of the frame is defined, this field is enable only when the field Transport Protocol and/or Fast Packet are checked;
- If the field "Request" is checked, the data can be send when the converter receive the "On Request" command (PGN: 0x00EA00+Destination Address) of the defined PGN/Source Address;
- If the field "Data Change" is checked, the frame is sent when the data changes;
- If the field "On Timer" is checked, the frame is send cyclically;
- In the field "Send Timer" insert the interval used for the "On Timer". The time is in milliseconds;
- In the field "Mnemonic" it is possible to insert a brief description.

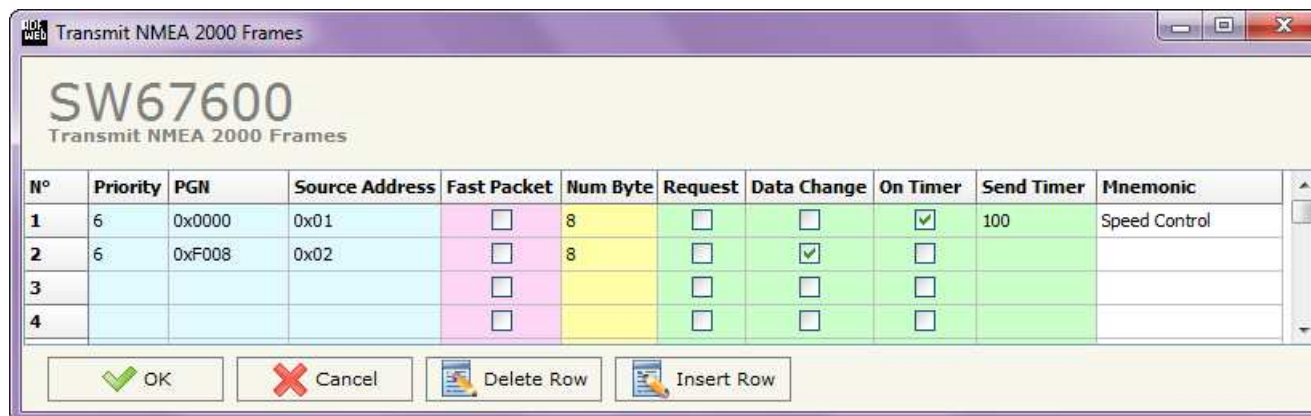

Figure 5: "Send NMEA 2000 Frames" window



Note:

It is possible to configure a maximum of 62 frames in the "Transmit NMEA 2000 Frames" section.

UPDATE DEVICE:

By pressing the **"Update Device"** button, it is possible to load the created configuration into the device; and also the Firmware, if necessary. This by using the Ethernet port.

If you don't know the actual IP address of the device you have to use this procedure:

- Turn off the Device;
- Put Dip2 of 'Dip-Switch A' in ON position;
- Turn on the device
- Connect the Ethernet cable;
- Insert the IP **"192.168.2.205"**;
- Press the **"Ping"** button, "Device Found! must appear";
- Press the **"Next"** button;
- Select which operations you want to do;
- Press the **"Execute update firmware"** button to start the upload;
- When all the operations are "OK" turn off the Device;
- Put Dip2 of 'Dip-Switch A' in OFF position;
- Turn on the device.

At this point the configuration/firmware on the device is correctly updated.

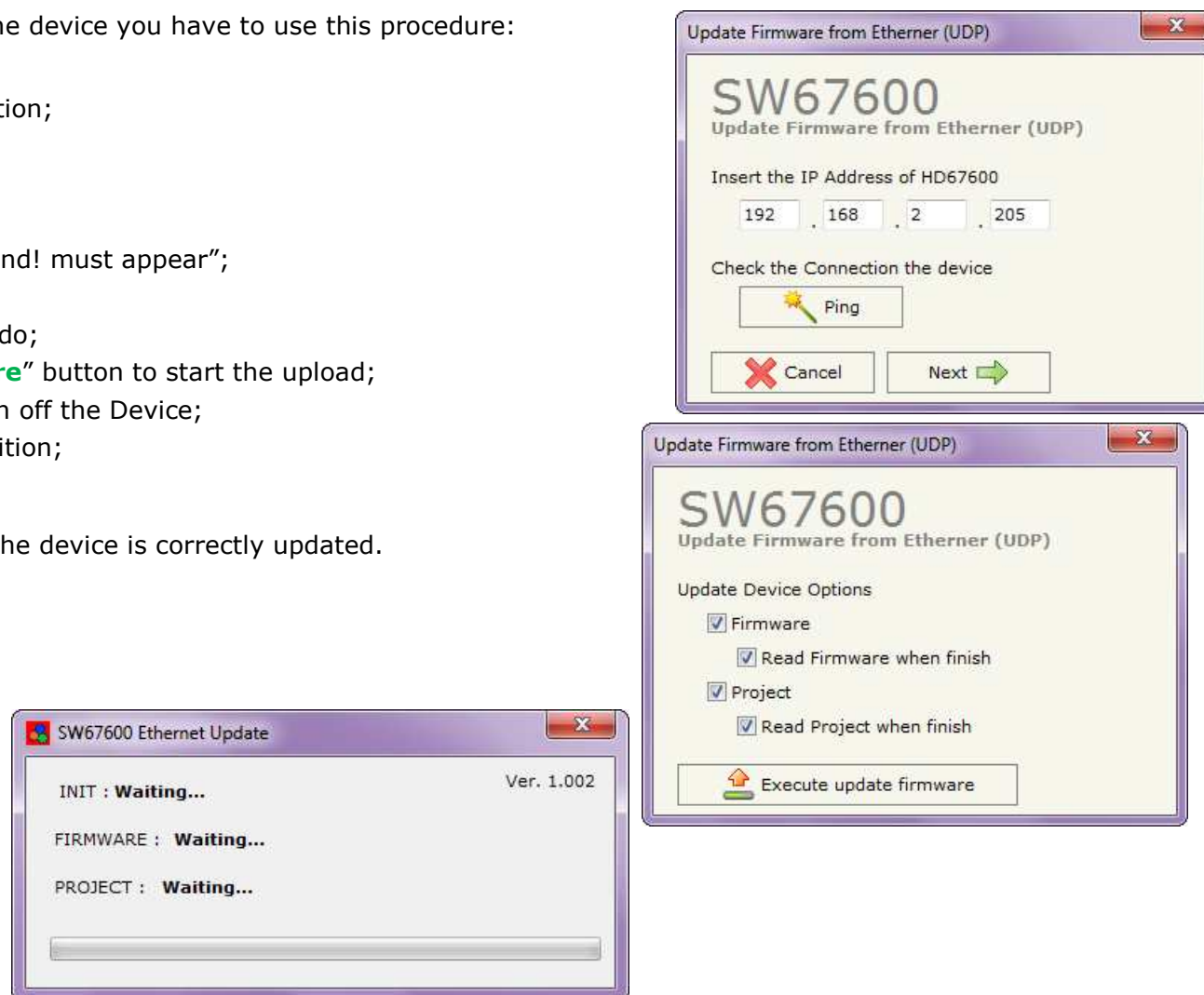



Figure 6: "Update device" windows

If you know the actual IP address of the device, you have to use this procedure:

- Turn on the Device with the Ethernet cable inserted;
- Insert the actual IP of the Converter;
- Press the "**Ping**" button, must appear "Device Found!";
- Press the "**Next**" button;
- Select which operations you want to do;
- Press the "**Execute update firmware**" button to start the upload;
- When all the operations are "OK" the device automatically goes at Normal Mode.

At this point the configuration/firmware on the device is correctly updated.

 **Note:** When you install a new version of the software, if it is the first time it is better you do the update of the Firmware in the HD67600-A1 device.

 **Note:** When you receive the device, for the first time, you also have to update the Firmware in the HD67600-A1 device.

**Warning:**

If Fig. 7 appears when you try to do the Update try these points before seeking assistance:

- Try to repeat the operations for the updating;
- Try with another PC;
- Try to restart the PC;
- Check the LAN settings;
- If you are using the program inside a Virtual Machine, try to use in the main Operating System;
- If you are using Windows Seven, Vista and 8 make sure that you have the administrator privileges;
- In case you have to program more than one device, using the "UDP Update", you have to cancel the ARP table every time you connect a new device on Ethernet. For do this you have to launch the "Command Prompt" and write the command "arp -d". Pay attention that with Windows Vista, Seven, 8 you have to launch the "Command Prompt" with Administrator Rights;
- Take attention at Firewall lock.

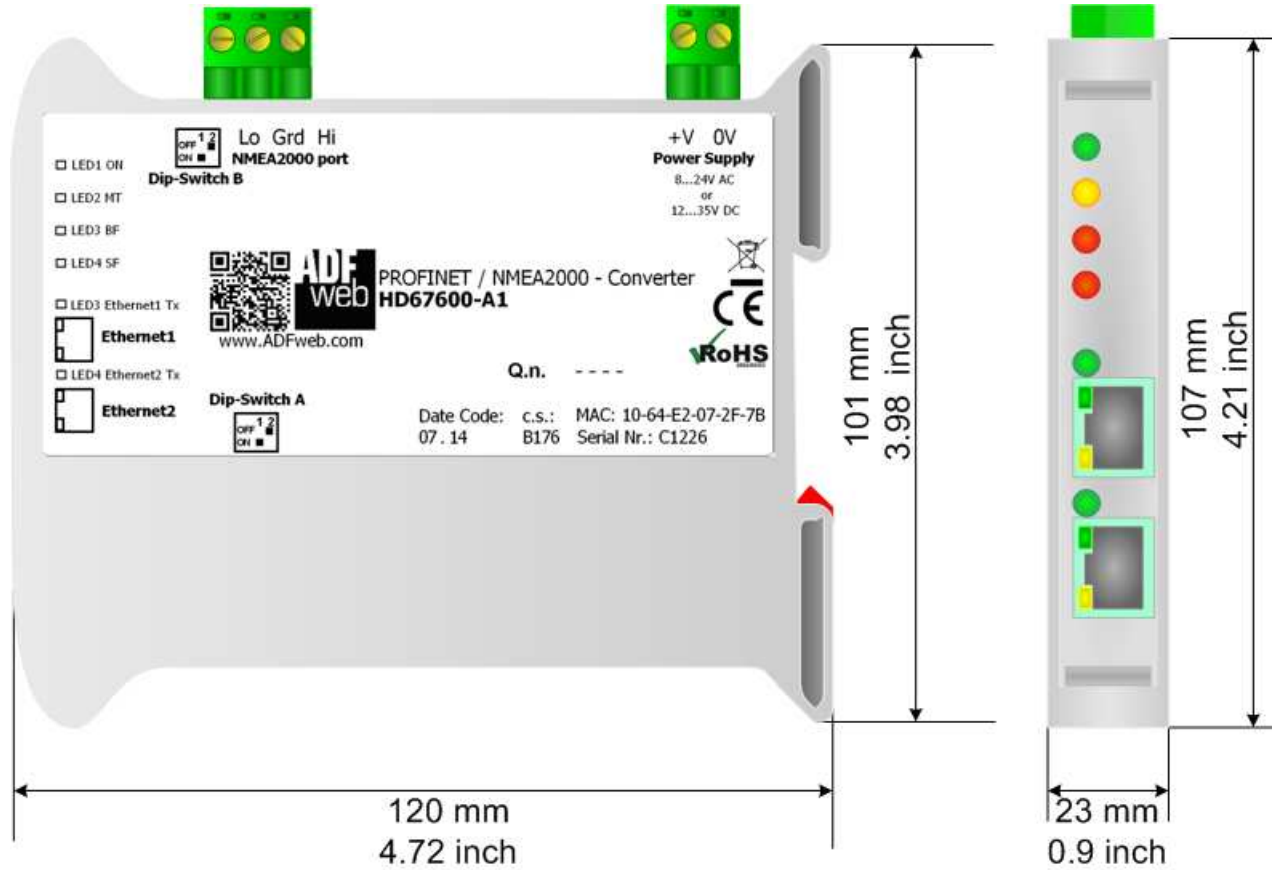

Figure 7: "Protection" windows

**Warning:**

In the case of HD67600-A1 you have to use the software "SW67600": www.adfweb.com/download/filefold/SW67600.zip.

MECHANICAL DIMENSIONS:



Housing: PVC
Weight: 200g (Approx)

Figure 8: Mechanical dimensions scheme for HD67600-A1

ORDERING INFORMATION:

The ordering part number is formed by a valid combination of the following:

HD67600 - A 1

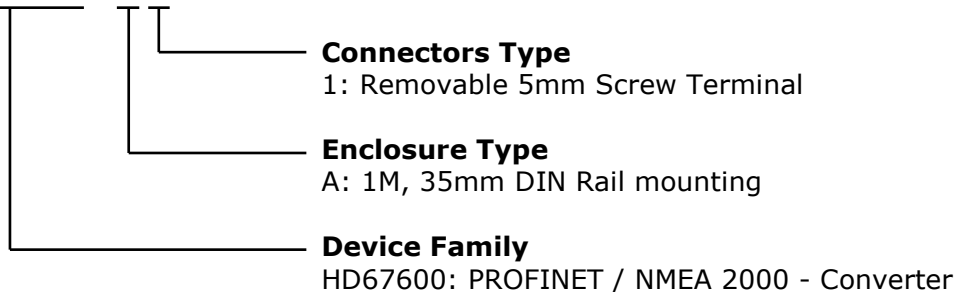

Order Code: **HD67600-A1** - PROFINET / NMEA 2000 - Converter

ACCESSORIES:

Order Code: **AC34001** - 35mm Rail DIN - Power Supply 220/240V AC 50/60Hz – 12 V AC

Order Code: **AC34002** - 35mm Rail DIN - Power Supply 110V AC 50/60Hz – 12 V AC

PLC CONFIGURATION:

The configuration and commissioning of the PROFINET Converter as described on the following pages was accomplished with the help of the TIA Portal V11-software by Siemens. In the case of using a control system from another supplier, refer to attend to the associated documentation.

These are the steps to follow:

- 1) Install the description file of the module.

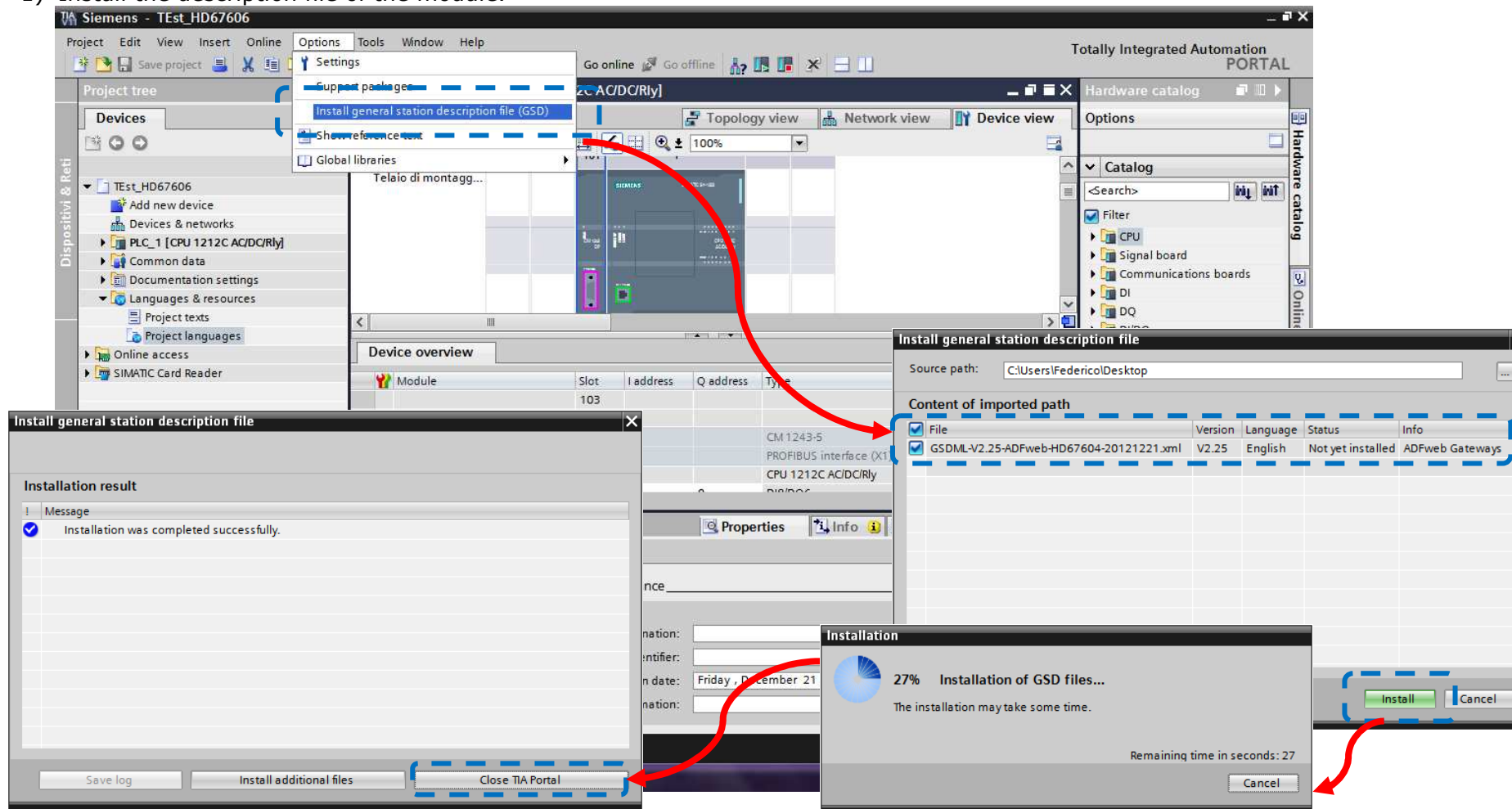

- 2) Press the “**Devices and networks**” button (1), from the right drop-down menu, under “Other field devices→PROFINET IO→Gateway→ADFWEB.com→HD67600” double click on “DNslave” module (2).



Note:

If you have installed more than one GSD file, go to the Information section and in the “Version” field select the correct gsd file (3), before double clicking on “DNslave” module

- 3) Connect the PLC to the HD67600 module by drawing the Ethernet wire between the two Ethernet ports. Then assign the IP Address **(1)** defined in the Compositor_SW67600 to the HD67600. Then double click the "Module" **(2)**.

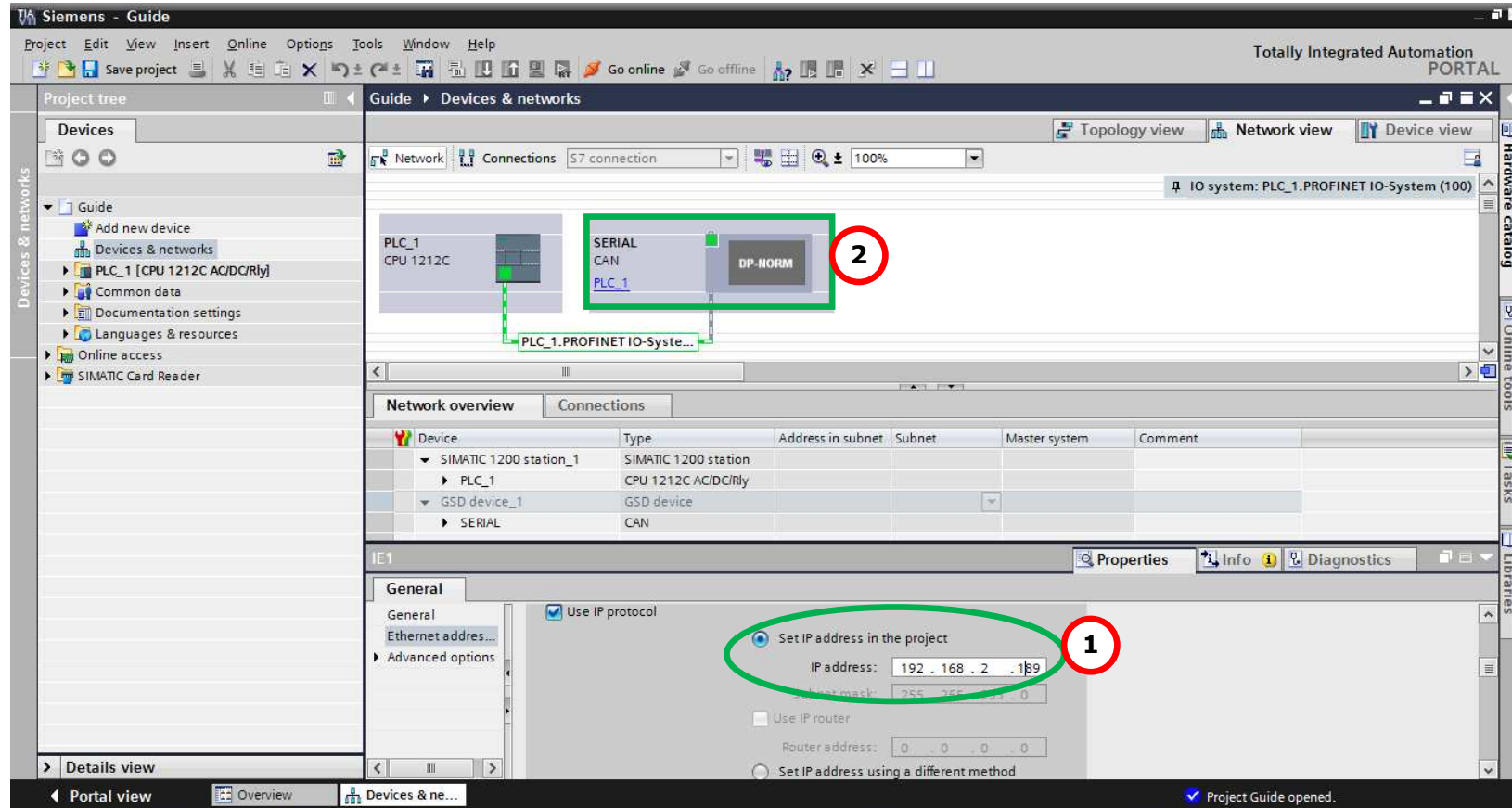

- 4) Then doubleclick on the "DNslave" label **(1)** and in the field name change it accordingly to the name defined in the Compositor_SW67600 **(2)**. Then add the main module "Module" and the sub-modules of "Digital Input" and "Digital Output" by double click on the three items in this order "Module" **(3)**, "Submodule 1" **(4)**, "Submodule 2" **(5)**.

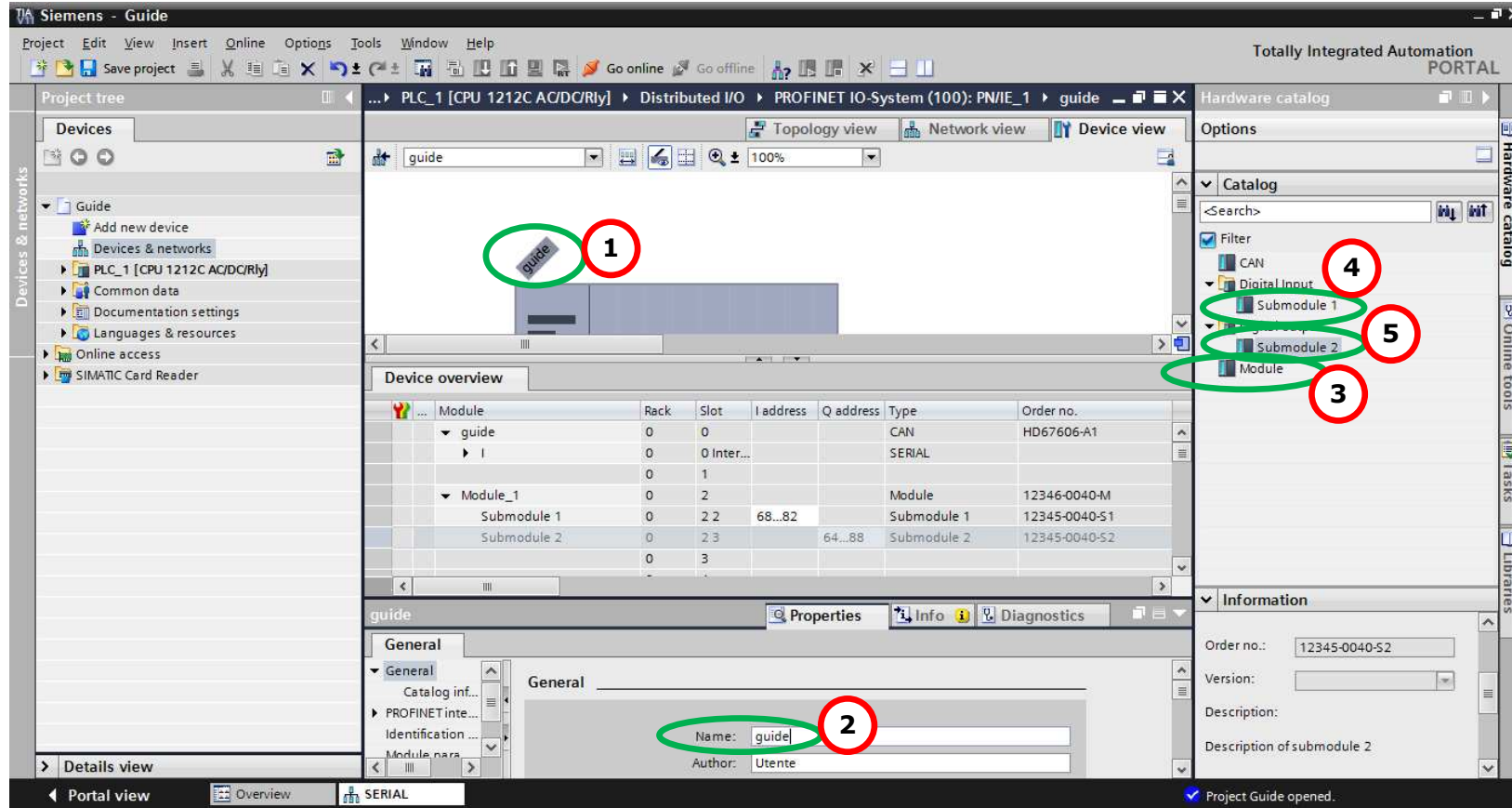

5) Load the configuration into the PLC.

Configured access nodes of "PLC_1"

Device	Device type	Type	Address	Subnet
PLC_1	CPU 1212C AC/D...	PNI/E	192.168.2.50	PNI/E_1
CM 1243-5	CM 1243-5	PROFIBUS	2	

Type of the PG/PC interface:

PG/PC interface:

Connection to subnet:

1st gateway:

Accessible devices in target subnet: Show all accessible devices

Device	Device type	Type	Address	Target device
PLC_1	CPU 1212C AC/D...	PNI/E	192.168.2.50	PLC_1
--	--	PNI/E	Access address	--

Flash LED

Online status information:
 Connected to address 192.168.2.50
 Scanning ended.

Buttons: Refresh, Load, Cancel

Load preview

? Check before loading

Status	!	Target	Message	Action
<input checked="" type="checkbox"/>		PLC_1	Ready for loading.	
<input checked="" type="checkbox"/>		▶ Stop modules	All modules will be stopped for downloading to device.	Stop all
<input checked="" type="checkbox"/>		▶ Device configurati...	Delete and replace system data in target	Download to device
<input checked="" type="checkbox"/>		▶ Software	Download software to device	Consistent download
<input checked="" type="checkbox"/>		▶ Additional inform...	There are differences between the settings for the project and the se	<input checked="" type="checkbox"/> Overwrite all

Buttons: Refresh, Finish, Load, Cancel

DISCLAIMER:

All technical content within this document can be modified without notice. The content of the document is a under continual renewal. For losses due to fire, earthquake, third party access or other accidents, or intentional or accidental abuse, misuse, or use under abnormal conditions repairs are charged to the user. ADFweb.com S.r.l. will not be liable for accidental loss of use or inability to use this product, such as loss of business income. ADFweb.com S.r.l. shall not be liable for consequences of improper use.

OTHER REGULATIONS AND STANDARDS:**WEEE INFORMATION**

Disposal of old electrical and electronic equipment (as in the European Union and other European countries with separate collection systems).

— This symbol on the product or on its packaging indicates that this product may not be treated as household rubbish. Instead, it should be taken to an applicable collection point for the recycling of electrical and electronic equipment. If the product is disposed correctly, you will help prevent potential negative environmental factors and impact of human health, which could otherwise be caused by inappropriate disposal. The recycling of materials will help to conserve natural resources. For more information about recycling this product, please contact your local city office, your household waste disposal service or the shop where you purchased the product.

RESTRICTION OF HAZARDOUS SUBSTANCES DIRECTIVE

The device respects the 2002/95/EC Directive on the restriction of the use of certain hazardous substances in electrical and electronic equipment (commonly referred to as Restriction of Hazardous Substances Directive or RoHS).

CE MARKING

The product conforms with the essential requirements of the applicable EC directives.

WARRANTIES AND TECHNICAL SUPPORT:

For fast and easy technical support for your ADFweb.com SRL products, consult our internet support at www.adfweb.com.
Otherwise contact us at the address support@adfweb.com

RETURN POLICY:

If while using your product you have any problem and you wish to exchange or repair it, please do the following:

- Obtain a Product Return Number (PRN) from our internet support at www.adfweb.com. Together with the request, you need to provide detailed information about the problem.
- Send the product to the address provided with the PRN, having prepaid the shipping costs (shipment costs billed to us will not be accepted).

If the product is within the warranty of twelve months, it will be repaired or exchanged and returned within three weeks. If the product is no longer under warranty, you will receive a repair estimate.



ADFweb.com S.r.l.
Via Strada Nuova, 17
IT-31010 Mareno di Piave
TREVISO (Italy)
Phone +39.0438.30.91.31
Fax +39.0438.49.20.99
www.adfweb.com

