

User Manual

Revision 1.000
English

- ✦ Triple electrical isolation
- ✦ Power Supply 18...35V DC and 8...24 V AC
- ✦ Temperature range: -40°C/+85°C (-40°F/+185°F)



User Manual

INDEX:

	Page
INDEX	2
UPDATED DOCUMENTATION	2
REVISION LIST	2
WARNING	2
TRADEMARKS	2
SECURITY ALERT	3
EXAMPLE OF CONNECTION	4
CONNECTION SCHEME	5
CHARACTERISTICS	6
CONFIGURATION	6
POWER SUPPLY	7
FUNCTION MODES	8
LEDS	9
ETHERNET	10
USE OF COMPOSITOR SW67B47	11
NEW PROJECT / OPEN PROJECT	12
SOFTWARE OPTIONS	13
SET COMMUNICATION	15
OPC UA ACCESS	16
SNMP SET ACCESS	17
UPDATE DEVICE	19
MECHANICAL DIMENSIONS	21
ORDERING INFORMATIONS	22
ACCESSORIES	22
DISCLAIMER	23
OTHER REGULATIONS AND STANDARDS	23
WARRANTIES AND TECHNICAL SUPPORT	24
RETURN POLICY	24

UPDATED DOCUMENTATION:

Dear customer, we thank you for your attention and we remind you that you need to check that the following document is:

- Updated
- Related to the product you own

To obtain the most recently updated document, note the “document code” that appears at the top right-hand corner of each page of this document.

With this “Document Code” go to web page www.adfweb.com/download/ and search for the corresponding code on the page. Click on the proper “Document Code” and download the updates.

REVISION LIST:

Revision	Date	Author	Chapter	Description
1.000	13/03/2019	Tf	All	First release version

WARNING:

ADFweb.com reserves the right to change information in this manual about our product without warning.
ADFweb.com is not responsible for any error this manual may contain.

TRADEMARKS:

All trademarks mentioned in this document belong to their respective owners.

SECURITY ALERT:**GENERAL INFORMATION**

To ensure safe operation, the device must be operated according to the instructions in the manual. When using the device, legal and safety regulation are required for each individual application. The same applies also when using accessories.

INTENDED USE

Machines and systems must be designed so the faulty conditions do not lead to a dangerous situation for the operator (i.e. independent limit switches, mechanical interlocks, etc.).

QUALIFIED PERSONNEL

The device can be used only by qualified personnel, strictly in accordance with the specifications.

Qualified personnel are persons who are familiar with the installation, assembly, commissioning and operation of this equipment and who have appropriate qualifications for their job.

RESIDUAL RISKS

The device is state-of-the-art and is safe. The instruments can represent a potential hazard if they are inappropriately installed and operated by untrained personnel. These instructions refer to residual risks with the following symbol:



This symbol indicates that non-observance of the safety instructions is a danger for people that could lead to serious injury or death and / or the possibility of damage.

CE CONFORMITY

The declaration is made by our company. You can send an email to or give us a call if you need it.

EXAMPLE OF CONNECTION:

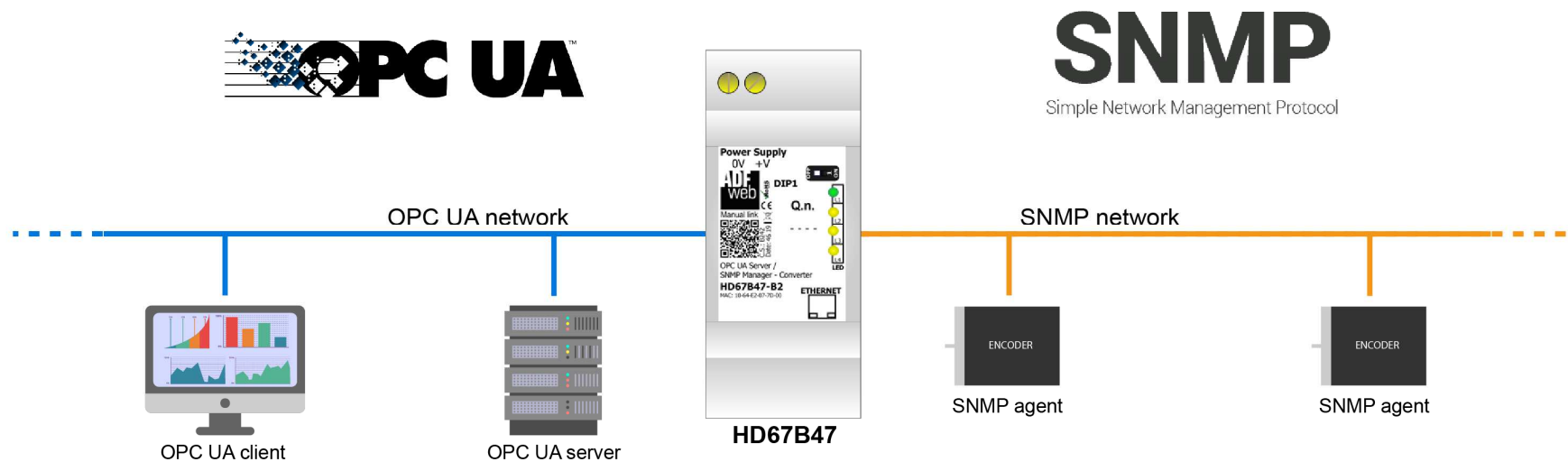

ADFweb ADFweb.com srl
 Tel. +39 0438 309 131 - Fax +39 0438 492 099
 info@adfweb-com - www.adfweb.com

CONNECTION SCHEME:

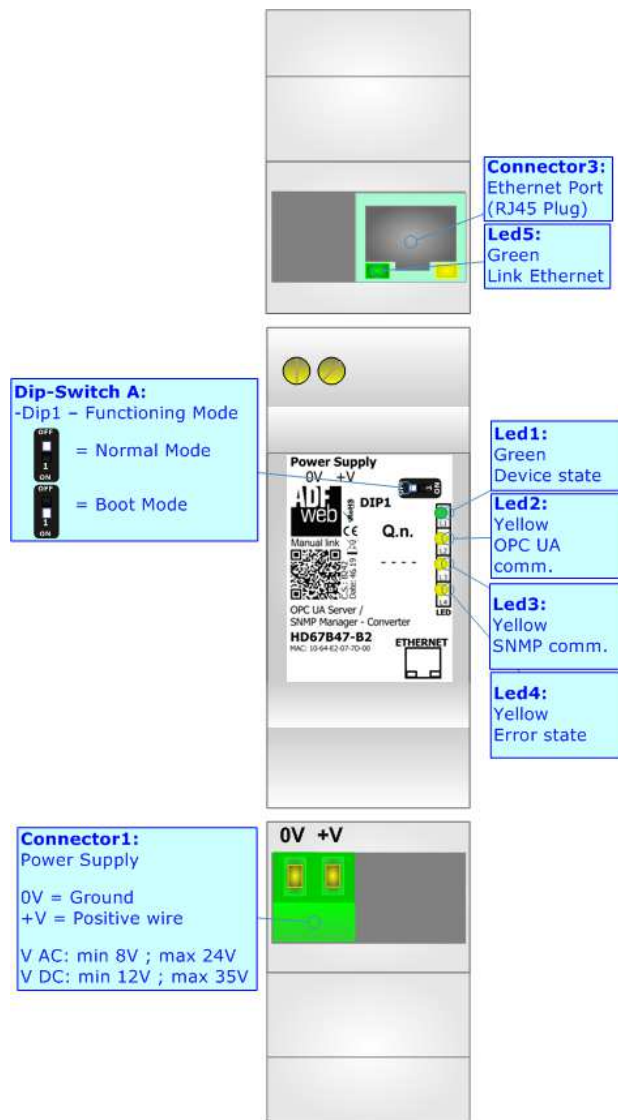

Figure 1: Connection scheme for HD67B47-B2

CHARACTERISTICS:

The HD67B47-B2 is a OPC UA Server / SNMP Manager converter.

It allows the following characteristics:

- Up to 1500 bytes in reading and 1500 bytes in writing;
- Two-directional information between SNMP and OPC UA;
- Mountable on 35mm Rail DIN;
- Wide power supply input range: 8...24V AC or 12...35V DC;
- Wide temperature range: -40°C / 85°C [-40°F / +185°F].

CONFIGURATION:

You need Compositor SW67B47 software on your PC in order to perform the following:

- Define the parameter of the OPC UA;
- Define the parameter of the SNMP;
- Define the SNMP requests to send to the SNMP Agents;
- Update the device.

POWER SUPPLY:

The devices can be powered between a wide range of tensions. For more details see the two tables below.

	VAC		VDC	
	Vmin	Vmax	Vmin	Vmax
HD67B47-B2	8V	24V	12V	35V

Consumption at 24V DC:

Device	W/VA
HD67B47-B2	4



Caution: Not reverse the polarity power

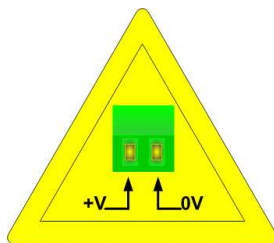

HD67B47-B2



Connector1:
Power Supply
0V = Ground
+V = Positive wire
V AC: min 8V ; max 24V
V DC: min 12V ; max 35V

FUNCTION MODES:

The device has got two functions mode depending of the position of the Dip1 of 'Dip-Switch A':

- The first, with Dip1 in Off position (factory setting), is used for the normal working of the device.
- The second, with Dip1 in On position, is used for upload the Project/Firmware.

For the operations to follow for the updating (see 'UPDATE DEVICE' section).

According to the functioning mode, the LEDs will have specifics functions (see 'LEDS' section).

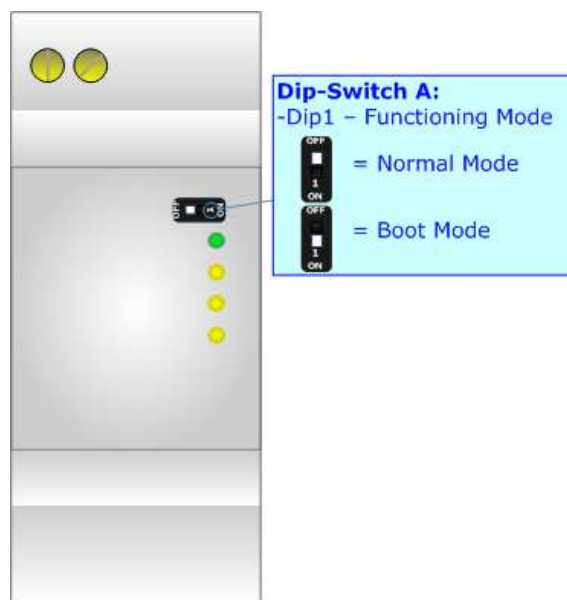

LEDS:

The device has got six LEDs that are used to give information of the functioning status. The various meanings of the LEDs are described in the table below.

LED	Normal Mode	Boot Mode
1: Device State (green)	Blinks slowly (~1Hz)	Blinks quickly: Boot state Blinks very slowly (~0.5Hz): update in progress
2: OPC UA comm. (yellow)	Flashing: OPC UA request OFF: OPC UA request	Blinks quickly: Boot state Blinks very slowly (~0.5Hz): update in progress
3: SNMP comm. (yellow)	Flashing: SNMP response OFF: No SNMP response	Blinks quickly: Boot state Blinks very slowly (~0.5Hz): update in progress
4: Error state (yellow)	ON: At least one OPC UA Server is disconnected OFF: all OPC UA Servers are connected	Blinks quickly: Boot state Blinks very slowly (~0.5Hz): update in progress
5: Link Ethernet (green)	ON: Ethernet cable connected OFF: Ethernet cable disconnected	ON: Ethernet cable connected OFF: Ethernet cable disconnected

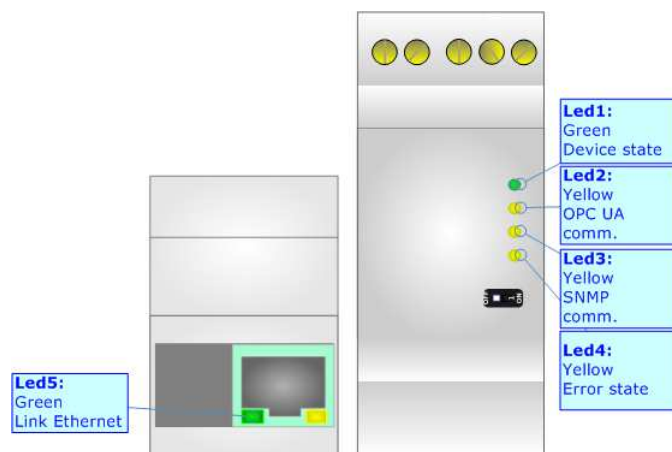

ETHERNET:

The Ethernet connection must be made using Connector3 of HD67B47-B2 with at least a Category 5E cable. The maximum length of the cable should not exceed 100m. The cable has to conform to the T568 norms relative to connections in cat.5 up to 100 Mbps. To connect the device to an Hub/Switch is recommended the use of a straight cable, to connect the device to a PC/PLC/other is recommended the use of a cross cable.

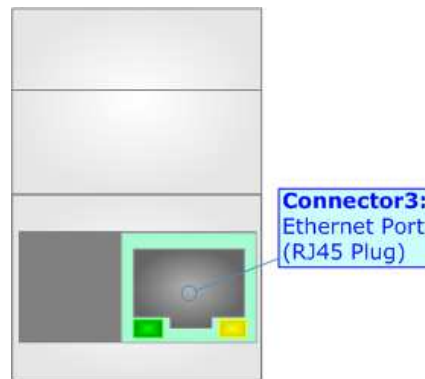

USE OF COMPOSITOR SW67B47:

To configure the Converter, use the available software that runs with Windows called SW67B47. It is downloadable on the site www.adfweb.com and its operation is described in this document. *(This manual is referenced to the last version of the software present on our web site)*. The software works with MSWindows (XP, Vista, Seven, 8, 10; 32/64bit).

When launching the SW67B47, the window below appears (Fig. 2).

 **Note:**
It is necessary to have installed .Net Framework 4.

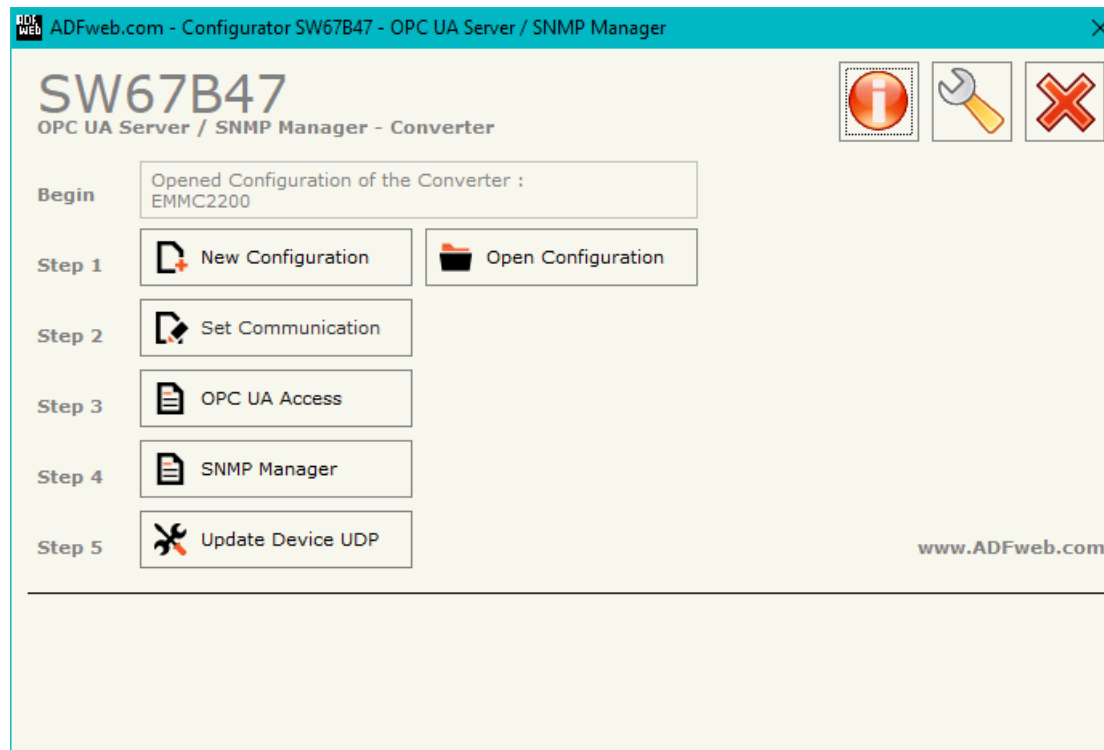
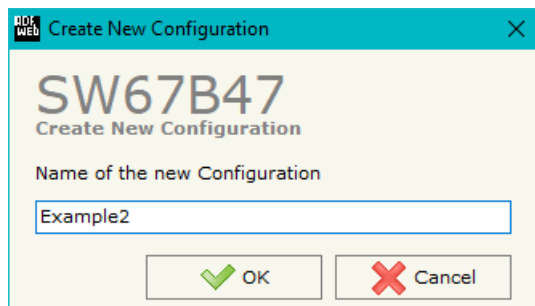

Figure 2: Main window for SW67B47

NEW CONFIGURATION / OPEN CONFIGURATION:

The “**New Configuration**” button creates the folder which contains the entire device’s configuration.



A device’s configuration can also be imported or exported:

- To clone the configurations of a programmable “OPC UA Server / SNMP Manager - Converter” in order to configure another device in the same manner, it is necessary to maintain the folder and all its contents;
- To clone a project in order to obtain a different version of the project, it is sufficient to duplicate the project folder with another name and open the new folder with the button “**Open Configuration**”.

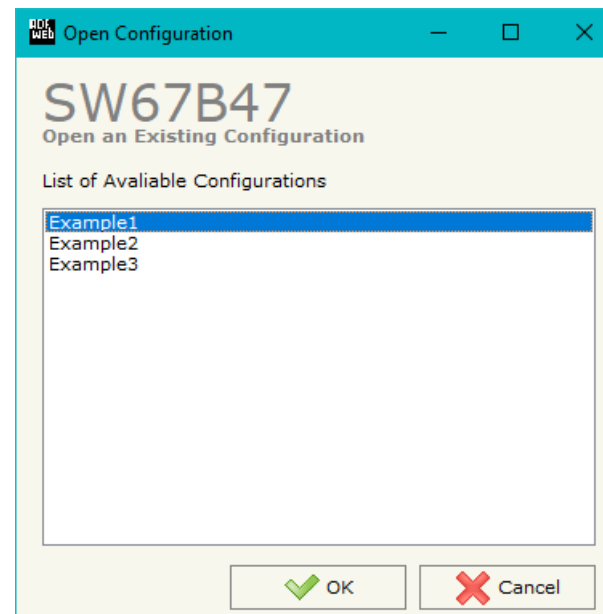

SOFTWARE OPTIONS:

By pressing the “**Settings**” () button there is the possibility to change the language of the software and check the updatings for the compositor.

In the section “Language” it is possible to change the language of the software.

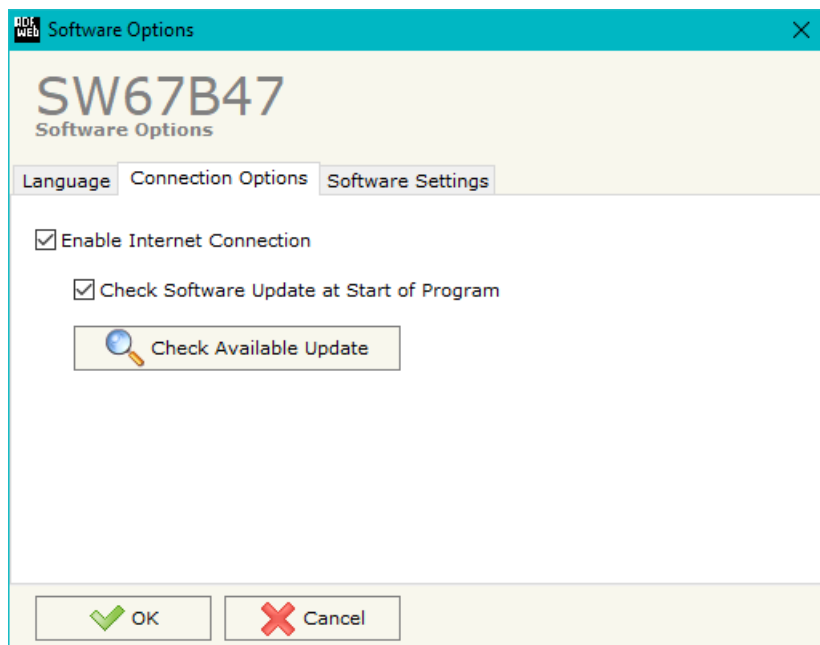

In the section “Connection Options”, it is possible to check if there are some updatings of the software compositor in ADFweb.com website. Checking the option “**Check Software Update at Start of Program**”, the SW67B47 check automatically if there are updatings when it is launched.

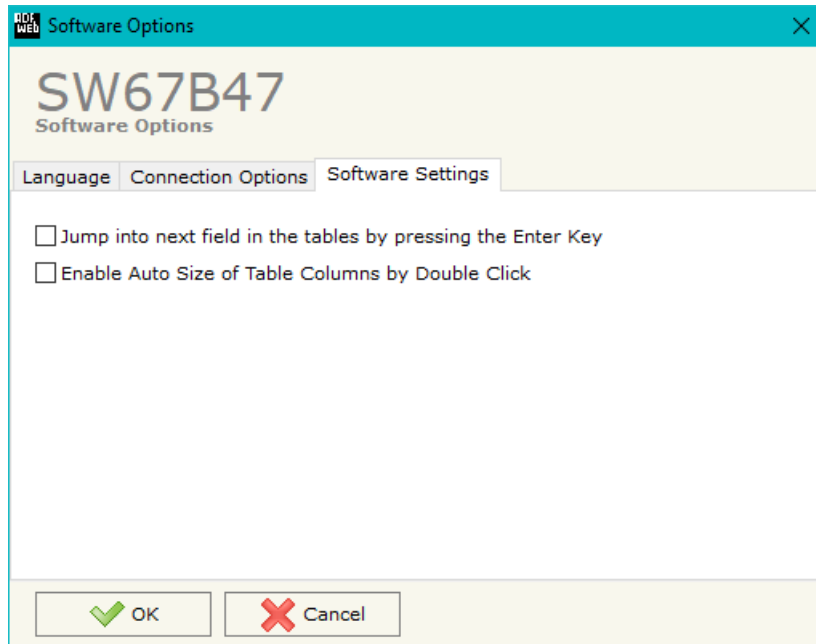

In the section "Software Settings", it is possible to enable/disable some keyboard's commands for an easier navigation inside the tables contained in the different sections of the software.

SET COMMUNICATION:

This section define the fundamental communication parameters of two buses, OPC UA Server and SNMP Manager.

By Pressing the **"Set Communication"** button from the main window for SW67B47 (Fig. 2) the window "Set Communication" appears (Fig. 3).

The means of the fields for "OPC UA Server" are:

- In the field **"IP Address"** the IP address of the converter is defined;
- In the field **"Subnet Mask"** the SubNet Mask of the converter is defined;
- In the field **"GATEWAY"** the default gateway of the net is defined. This feature can be enabled or disabled pressing the Check Box field. This feature is used for going out of the net;
- In the field **"DNS"** the DNS address is defined. This field is required if the server address is define by URL and not IP Address.
- In the field **"Port"** the port used for OPC UA communication is defined.

The means of the fields for "SNMP Manager" are:

- In the field **"IP ADDRESS"** the IP address that you want to give to the SNMP side is defined;
- In the field **"SUBNET Mask"** the SubNet Mask of the SNMP side is defined;
- In the field **"GATEWAY"** the default gateway that you want to use is defined. This feature can be enabled or disabled pressing the Check Box field. This feature is used for going out of the net;
- In the field **"Name of Station"** it is possible to assign a name to the SNMP node.

The means of the fields for "NTP (Network Time Protocol)" are:

- In the field **"Server URL"** the URL or the IP Address of the NTP Server is defined;
- In the field **"Poll Time (seconds)"** the polling time for the time synchronization is defined.

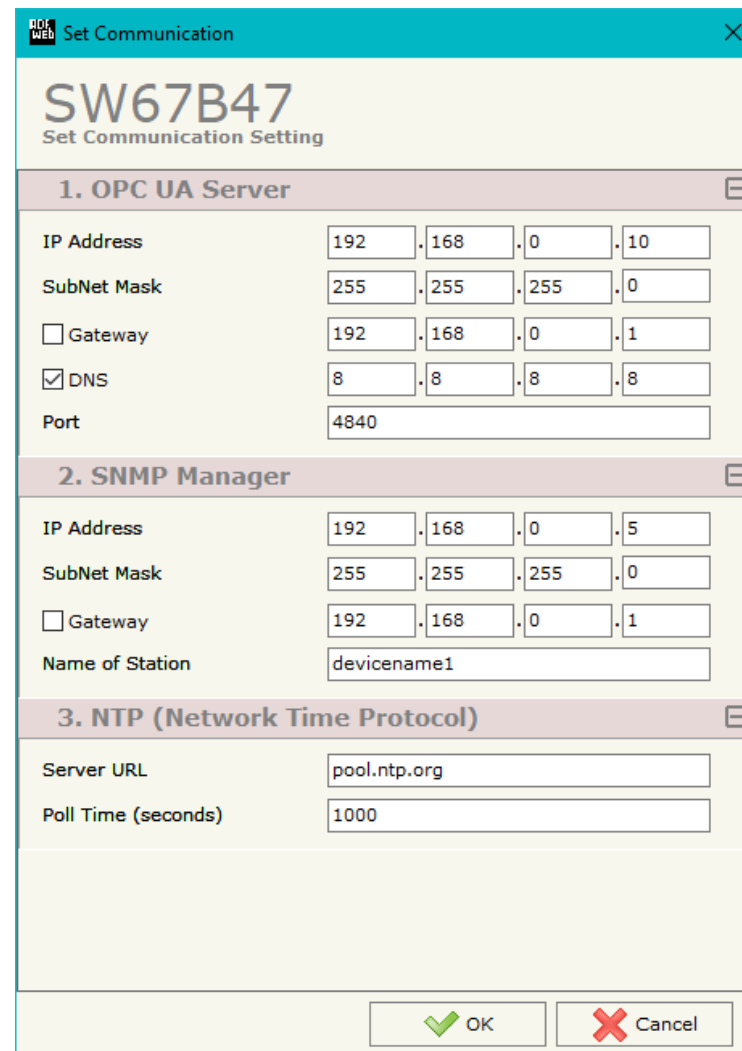

The screenshot shows the 'Set Communication' window for device SW67B47. It is divided into three main sections:

- 1. OPC UA Server:**
 - IP Address: 192.168.0.10
 - SubNet Mask: 255.255.255.0
 - Gateway: 192.168.0.1
 - DNS: 8.8.8.8
 - Port: 4840
- 2. SNMP Manager:**
 - IP Address: 192.168.0.5
 - SubNet Mask: 255.255.255.0
 - Gateway: 192.168.0.1
 - Name of Station: devicename1
- 3. NTP (Network Time Protocol):**
 - Server URL: pool.ntp.org
 - Poll Time (seconds): 1000

At the bottom right, there are two buttons: a green 'OK' button and a red 'Cancel' button.

Figure 3: "Set Communication" window

OPC UA ACCESS:

By Pressing the **"OPC UA Access"** button from the main window for SW67B48 (Fig. 2) the window "OPC UA Server Access" appears (Fig. 4). This section is used to define the list of OPC UA variables to read/write.

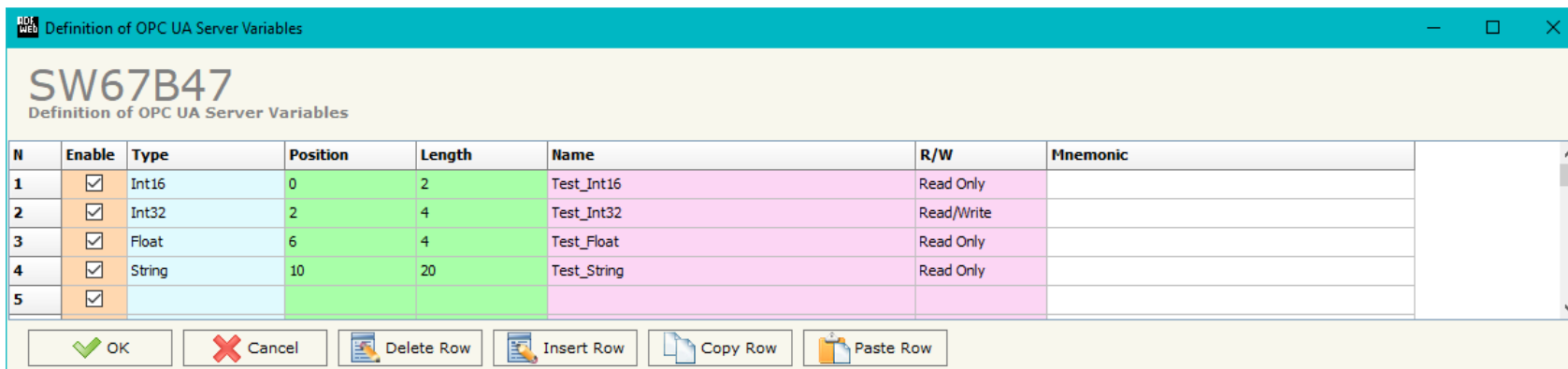

N	Enable	Type	Position	Length	Name	R/W	Mnemonic
1	<input checked="" type="checkbox"/>	Int16	0	2	Test_Int16	Read Only	
2	<input checked="" type="checkbox"/>	Int32	2	4	Test_Int32	Read/Write	
3	<input checked="" type="checkbox"/>	Float	6	4	Test_Float	Read Only	
4	<input checked="" type="checkbox"/>	String	10	20	Test_String	Read Only	
5	<input checked="" type="checkbox"/>						

Figure 4: "OPC UA Server Access" window

The means of the checkboxes inside the table are:

- If the field **"Enable"** is checked, the OPC UA variable is enabled;
- In the field **"Type"** the data format of the OPC UA variable is defined;
- In the field **"Position"** the starting byte of the internal memory arrays where getting the value is defined;
- In the field **"Length"** the byte length of the OPC UA variable is defined;
- In the field **"Name"** the name of the OPC UA variable is defined;
- In the field **"R/W"** the access type of the OPC UA variable is defined;
- In the field **"Mnemonic"** a description of the OPC UA variable is defined.

SNMP SET ACCESS:

N	Enable	IP Address	Version	Community Name	OID	Type	Mode	OnChange	OnCMD	OnTimer	Time	Position	Num Bytes	Conversion	Cancel	User	Auth Pass	Priv Pass	Security Level	Auth Mode	Priv Mode	Mnemonic
1	<input checked="" type="checkbox"/>	192.168.0.150	1	Public	1.3.6.1.4.1.33118	Int	Get	<input checked="" type="checkbox"/>	<input checked="" type="checkbox"/>	<input checked="" type="checkbox"/>	1000	0	2	None	<input type="checkbox"/>							
2	<input checked="" type="checkbox"/>	192.168.0.151	1	Private	1.3.6.1.4.1.33118	String	Trap	<input checked="" type="checkbox"/>	<input checked="" type="checkbox"/>	<input checked="" type="checkbox"/>	1000	2	10	None	<input type="checkbox"/>							
3	<input checked="" type="checkbox"/>							<input type="checkbox"/>	<input type="checkbox"/>	<input type="checkbox"/>					<input type="checkbox"/>							
4	<input checked="" type="checkbox"/>							<input type="checkbox"/>	<input type="checkbox"/>	<input type="checkbox"/>					<input type="checkbox"/>							
5	<input checked="" type="checkbox"/>							<input type="checkbox"/>	<input type="checkbox"/>	<input type="checkbox"/>					<input type="checkbox"/>							
6	<input checked="" type="checkbox"/>							<input type="checkbox"/>	<input type="checkbox"/>	<input type="checkbox"/>					<input type="checkbox"/>							
7	<input checked="" type="checkbox"/>							<input type="checkbox"/>	<input type="checkbox"/>	<input type="checkbox"/>					<input type="checkbox"/>							
8	<input checked="" type="checkbox"/>							<input type="checkbox"/>	<input type="checkbox"/>	<input type="checkbox"/>					<input type="checkbox"/>							
9	<input checked="" type="checkbox"/>							<input type="checkbox"/>	<input type="checkbox"/>	<input type="checkbox"/>					<input type="checkbox"/>							

Figure 5: "Set SNMP Manager Access" window

By Pressing the "SNMP Manager" button from the main window for SW67B47 (Fig. 2) the window "Set SNMP Manager Access" appears (Fig. 5).

The meaning of the fields in the window are the follows:

- If the field "Enable" is checked, the SNMP request is enabled;
- In the field "IP Address" the address of the SNMP Manager device to read/write is defined;
- In the field "Version" the SNMP version used to send the SNMP request (1 or 2 is allowed) is defined;
- In the field "Community Name" the Community Name used for the SNMP request is defined (selectable or editable manually);
- In the field "OID" the OID to read/write from/to the SNMP Agent device is defined;
- In the field "Type" the type of data to read/write ('String' or 'Int') is defined;
- In the field "Mode" the type of SNMP request used ('Get', 'Set' or 'Trap') is defined;
- By checking the field "On Change" the SNMP request (only for 'Set' Mode) is made only if data written by the OPC UA Client are changed;
- By checking the field "OnCMD" the SNMP request is sent only when a OPC UA command for the associated variable is received;
- If the field "On Timer" is checked, the SNMP request is sent cyclically;
- In the field "Time" the delay in ms between two SNMP requests is defined (if "On Timer" is checked);
- In the field "Position" it is possible to select the position where take/save the data from/to the internal memory array;
- In the field "Num Bytes" it is possible to select define the dimension of the SNMP data;

- In the field "**Conversion**" it is possible to select the conversion to apply to the data read/written from/to the SNMP Manager;
- If the field "**Cancel**" is checked, if the answer to the SNMP request is missing, the data on OPC UA side are set to '0';
- If SNMP version is set to '3', the following fields must be set:
 - In the field "**User**" the user for the SNMP authentication is defined;
 - In the field "**Auth Pass**" the password for the SNMP authentication is defined;
 - In the field "**Priv Pass**" the password for Privacy authentication is defined;
 - In the field "**Security Level**" the type of security used is defined;
 - In the field "**Auth Mode**" the mode used for the authentication is defined;
 - In the field "**Priv Mode**" the mode used for Privacy is defined;
- In the field "**Mnemonic**" a description of the data inserted in the row is defined.

**Note:**

If the field "On change" and "On Timer" is checked and the "Poll Time" is different from 0, the converter sends the SNMP writing request cyclically and also when the data is changed.

**Note:**

If the "Trap" mode is used, the fields "On Change" and "On Timer" must be disabled.

UPDATE DEVICE:

By pressing the **"Update Device"** button, it is possible to load the created Configuration into the device; and also the Firmware, if necessary. This by using the Ethernet port.

If you don't know the actual IP address of the device you have to use this procedure:

- Turn OFF the Device;
- Put Dip1 of 'Dip-Switch A' in ON position;
- Turn ON the device
- Connect the Ethernet cable;
- Insert the IP **"192.168.2.205"**;
- Select which operations you want to do;
- Press the **"Execute update firmware"** button to start the upload;
- When all the operations are "OK" turn OFF the Device;
- Put Dip1 of 'Dip-Switch A' in OFF position;
- Turn ON the device.

If you know the actual IP address of the device, you have to use this procedure:

- Turn ON the Device with the Ethernet cable inserted;
- Insert the actual IP of the Converter;
- Select which operations you want to do;
- Press the **"Execute update firmware"** button to start the upload;
- When all the operations are "OK" the device automatically goes at Normal Mode.

At this point the configuration/firmware on the device is correctly updated.

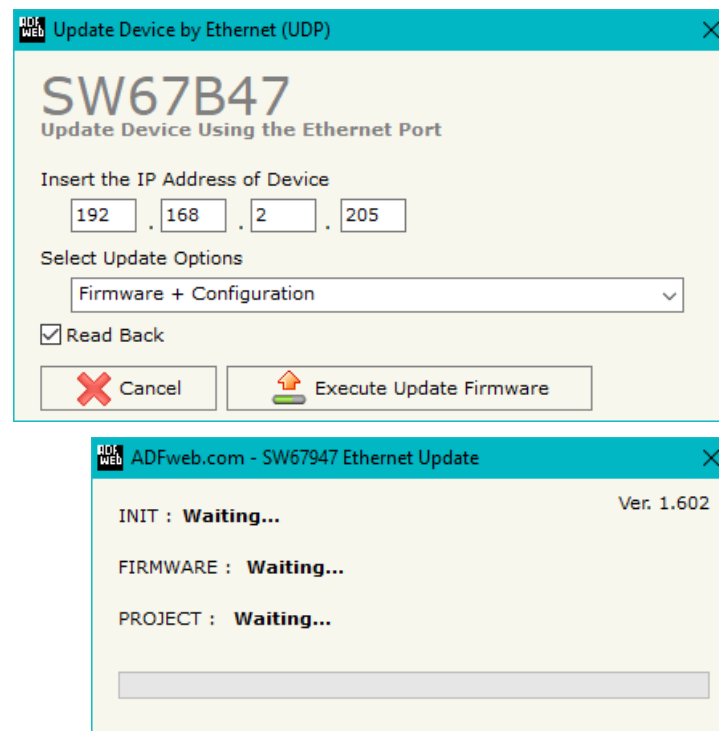

Figure 6: "Update device" windows



Note:

When you receive the device, for the first time, you also have to update the Firmware in the HD67B47 device.



Warning:

If Fig. 7 appears when you try to do the Update try these points before seeking assistance:

- Check if the serial cable is connected between the PC and the device;
- Try to repeat the operations for the updating;
- Try with another PC;
- Try to restart the PC;
- Check the LAN settings;
- If you are using the program inside a Virtual Machine, try to use in the main Operating System;
- If you are using Windows Seven, Vista, 8 or 10 make sure that you have the administrator privileges;
- In case you have to program more than one device, using the "UDP Update", you have to cancel the ARP table every time you connect a new device on Ethernet. For do this you have to launch the "Command Prompt" and write the command "arp -d". Pay attention that with Windows Vista, Seven, 8, 10 you have to launch the "Command Prompt" with Administrator Rights;
- Pay attention at Firewall lock.



Warning:

In the case of HD67B47 you have to use the software "SW67B47": www.adfweb.com/download/filefold/SW67B47.zip.

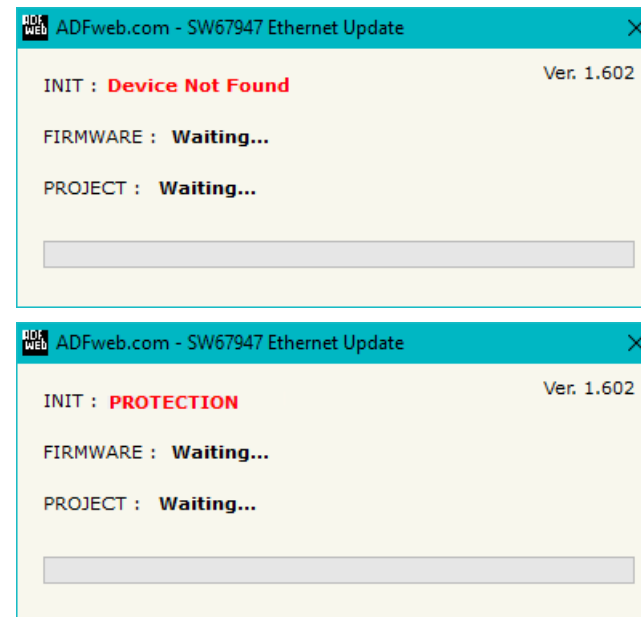
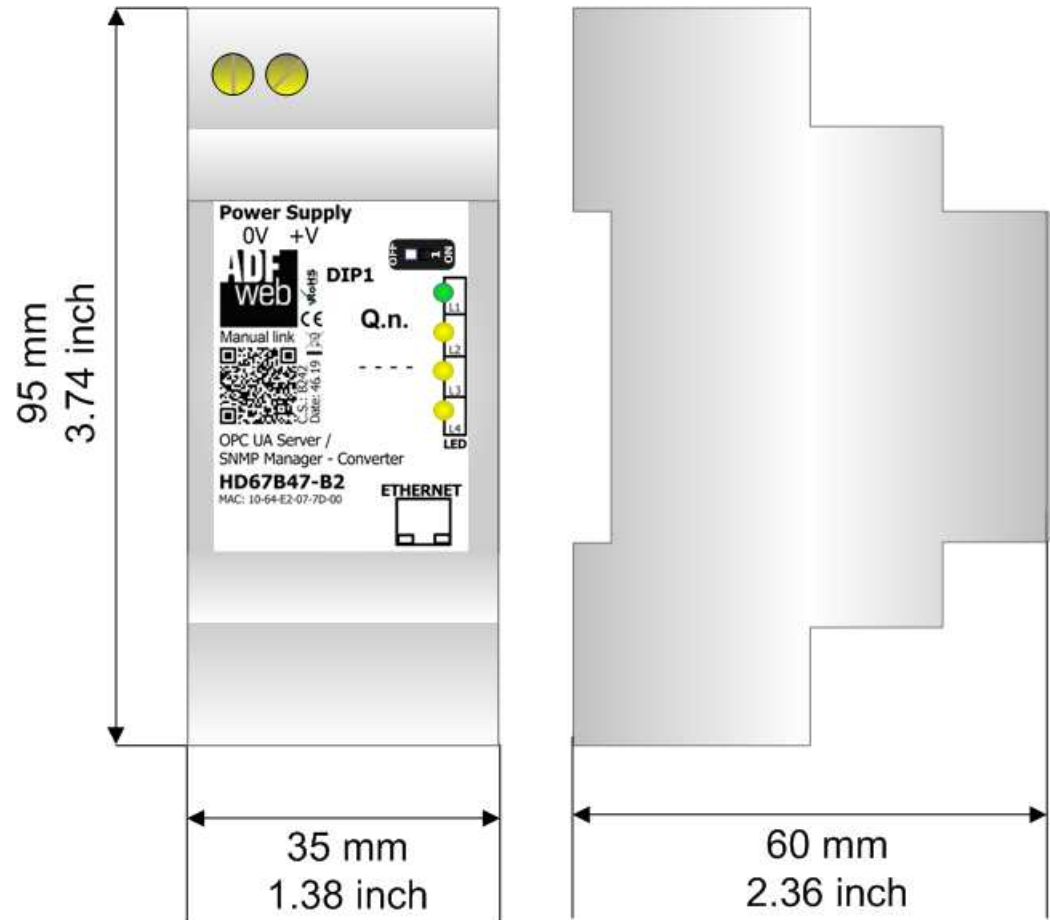

Figure 7: "Error" window

MECHANICAL DIMENSIONS:



Housing: PVC
 Weight: 200g
 (Approx)

Figure 8: Mechanical dimensions scheme for HD67B47-B2

ORDERING INFORMATIONS:

The ordering part number is formed by a valid combination of the following:

HD67B47 - B 2

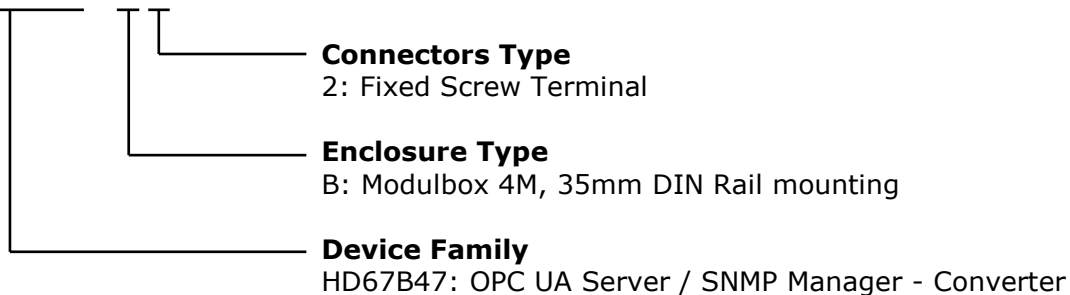

Order Code: **HD67B47-B2** - OPC UA Server / SNMP Manager - Converter

ACCESSORIES:

Order Code: **AC34011** - 35mm Rail DIN - Power Supply 220/240V AC 50/60Hz – 12 V DC

Order Code: **AC34012** - 35mm Rail DIN - Power Supply 220/240V AC 50/60Hz – 24 V DC

DISCLAIMER:

All technical content within this document can be modified without notice. The content of the document is a under continual renewal. For losses due to fire, earthquake, third party access or other accidents, or intentional or accidental abuse, misuse, or use under abnormal conditions repairs are charged to the user. ADFweb.com S.r.l. will not be liable for accidental loss of use or inability to use this product, such as loss of business income. ADFweb.com S.r.l. shall not be liable for consequences of improper use.

OTHER REGULATIONS AND STANDARDS:**WEEE INFORMATION**

Disposal of old electrical and electronic equipment (as in the European Union and other European countries with separate collection systems).

— This symbol on the product or on its packaging indicates that this product may not be treated as household rubbish. Instead, it should be taken to an applicable collection point for the recycling of electrical and electronic equipment. If the product is disposed correctly, you will help prevent potential negative environmental factors and impact of human health, which could otherwise be caused by inappropriate disposal. The recycling of materials will help to conserve natural resources. For more information about recycling this product, please contact your local city office, your household waste disposal service or the shop where you purchased the product.

RESTRICTION OF HAZARDOUS SUBSTANCES DIRECTIVE

The device respects the 2002/95/EC Directive on the restriction of the use of certain hazardous substances in electrical and electronic equipment (commonly referred to as Restriction of Hazardous Substances Directive or RoHS).

CE MARKING

The product conforms with the essential requirements of the applicable EC directives.

WARRANTIES AND TECHNICAL SUPPORT:

For fast and easy technical support for your ADFweb.com SRL products, consult our internet support at www.adfweb.com. Otherwise contact us at the address support@adfweb.com

RETURN POLICY:

If while using your product you have any problem and you wish to exchange or repair it, please do the following:

- Obtain a Product Return Number (PRN) from our internet support at www.adfweb.com. Together with the request, you need to provide detailed information about the problem.
- Send the product to the address provided with the PRN, having prepaid the shipping costs (shipment costs billed to us will not be accepted).

If the product is within the warranty of twelve months, it will be repaired or exchanged and returned within three weeks. If the product is no longer under warranty, you will receive a repair estimate.



ADFweb.com S.r.l.
 Via Strada Nuova, 17
 IT-31010 Mareno di Piave
 TREVISO (Italy)
 Phone +39.0438.30.91.31
 Fax +39.0438.49.20.99
www.adfweb.com

