

User Manual

Revision 3.100

English

CAN / Optic Fiber – Repeater – Extender bus line

(Order Code: HD67117F – HD67117FSX
HD67180F – HD67180FSX
HD67181F – HD67181FSX
HD67182F – HD67182FSX)

Benefits and Main Features:

- ⊕ Different baud rate of CAN branches
- ⊕ Very easy to configure
- ⊕ Triple electrical isolation
- ⊕ Protocol independent, allowing it to work with all the different CAN protocols and frame lengths
- ⊕ Temperature range: -40°C/85°C (-40°F/185°F)



User Manual

INDEX:

| | Page |
|---------------------------------------|------|
| INDEX | 2 |
| UPDATED DOCUMENTATION | 2 |
| REVISION LIST | 2 |
| WARNING | 2 |
| TRADEMARKS | 2 |
| SECURITY ALERT | 3 |
| INTRODUCTION | 4 |
| BENEFITS AND CHARACTERISTICS | 4 |
| "F" SERIES | 5 |
| "FSX" SERIES | 6 |
| CONNECTION SCHEME | 7 |
| POWER SUPPLY | 9 |
| FUNCTION MODES | 10 |
| LEDS (F SERIE) | 11 |
| LEDS (FSX SERIE) | 12 |
| CAN | 13 |
| SET SWITCH BAUD RATE FOR "F" SERIES | 14 |
| SET SWITCH BAUD RATE FOR "FSX" SERIES | 15 |
| ETHERNET | 16 |
| RS232 | 16 |
| USE OF COMPOSITOR SW67FSX | 17 |
| NEW PROJECT / OPEN PROJECT | 18 |
| SOFTWARE OPTIONS | 19 |
| SET COMMUNICATION | 20 |
| UPDATE VIA SERIAL | 21 |
| UPDATE VIA UDP | 22 |
| MECHANICAL DIMENSIONS | 24 |
| ORDER CODE | 26 |
| ACCESSORIES | 26 |
| DISCLAIMER | 27 |
| OTHER REGULATIONS AND STANDARDS | 27 |
| WARRANTIES AND TECHNICAL SUPPORT | 28 |
| RETURN POLICY | 28 |

UPDATED DOCUMENTATION:

Dear customer, we thank you for your attention and we remind you that you need to check that the following document is:

- Updated
- Related to the product you own

To obtain the most recently updated document, note the "document code" that appears at the top right-hand corner of each page of this document.

With this "Document Code" go to web page www.adfweb.com/download/ and search for the corresponding code on the page. Click on the proper "Document Code" and download the updates.

REVISION LIST:

| Revision | Date | Author | Chapter | Description |
|----------|------------|--------|---------|--------------------------|
| 3.000 | 15/06/2010 | Ft | All | New document format |
| 3.001 | 23/08/2011 | Fl | All | Revision |
| 3.002 | 15/02/2013 | Nt | All | Added new chapters |
| 3.100 | 23/09/2015 | Ff | All | New hardware version FSX |

WARNING:

ADFweb.com reserves the right to change information in this manual about our product without warning. ADFweb.com is not responsible for any error this manual may contain.

TRADEMARKS:

All trademarks mentioned in this document belong to their respective owners.

SECURITY ALERT:**GENERAL INFORMATION**

To ensure safe operation, the device must be operated according to the instructions in the manual. When using the device, legal and safety regulation are required for each individual application. The same applies also when using accessories.

INTENDED USE

Machines and systems must be designed so the faulty conditions do not lead to a dangerous situation for the operator (i.e. independent limit switches, mechanical interlocks, etc.).

QUALIFIED PERSONNEL

The device can be used only by qualified personnel, strictly in accordance with the specifications. Qualified personnel are persons who are familiar with the installation, assembly, commissioning and operation of this equipment and who have appropriate qualifications for their job.

RESIDUAL RISKS

The device is state-of-the-art and is safe. The instruments can represent a potential hazard if they are inappropriately installed and operated by untrained personnel. These instructions refer to residual risks with the following symbol:



This symbol indicates that non-observance of the safety instructions is a danger for people that could lead to serious injury or death and / or the possibility of damage.

CE CONFORMITY

The declaration is made by our company. You can send an email to or give us a call if you need it.

INTRODUCTION:

The "HD67XXXF" and "HD67XXXFSX" series are CAN Bus devices designed to extend high CAN bus signals to Fiber Optic cables, providing RFI and electrical isolation. These CAN bus bridges and repeaters support the CAN-based higher level protocols.

BENEFITS AND CHARACTERISTICS:**Benefits:**

- Naturally Resistant to Surges, Spikes and Electrical Noise;
- Multi Modal Optic Fiber up to 2000 meters;
- MAX baud rate 1Mb;
- Allows extension of a line segment (without lowering the Baud Rate);
- Extension of nodes number;
- Different baud rate setting;
- CAN Protocol independent;
- Microprocessor 16bit;
- Rail DIN mounting;
- Removable terminal block;
- Low Cost.

Characteristics:

- Electrical isolation ISO 11898/ISO IEC 11801
- Optical link: UP 2000 metres at 1Mbps;
- Copper link: 5000 m for 10Kbps and 25m for 1Mbps;
- Baud rate from 10k up to 1Mbs;
- Possible different baud rate setting (into different branches)
- Temperature range -40°C to 85°C;
- Mountable on Rail Din;
- Dimensions 120x23x107 (D x W x H);
- Weight 200g.

"F" SERIES

Bridges and repeaters for CANbus, CANopen, DeviceNet, J1939, CAN2.0A, CAN2.0B:

HD67117F CANopen to Optic Fiber Repeater;

HD67180F DeviceNet to Optic Fiber Repeater;

HD67181F CAN to Optic Fiber Repeater for generic use (Standard and Extended Protocol);

HD67182F J1939 to Optic Fiber Repeater.

Function scheme:

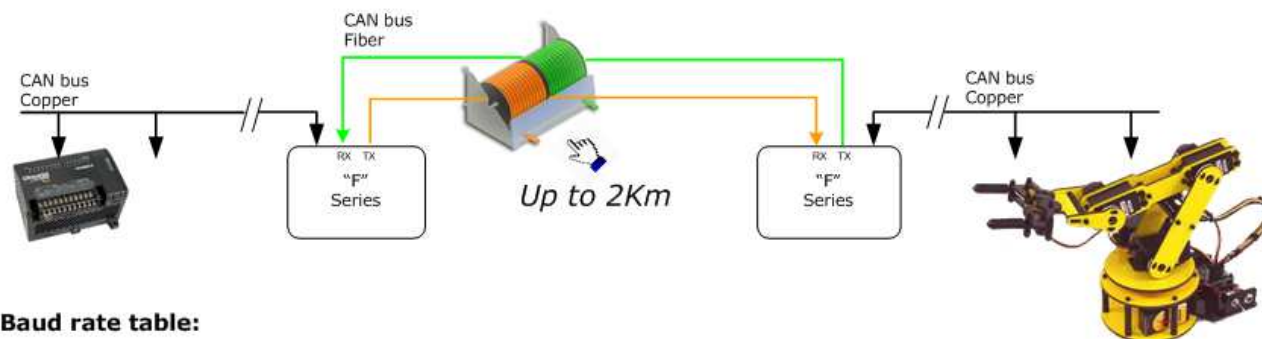

Baud rate table:

Copper Side:

| Baud rate [bps] | Lenght max [m] |
|-----------------|----------------|
| 10 K | 5000 |
| 20 K | 2500 |
| 50 K | 1000 |
| 100 K | 650 |
| 125 K | 500 |
| 250 K | 250 |
| 500 K | 100 |
| 800 K | 50 |
| 1000 K | 25 |

Fiber Optic Side:

| Baud rate [bps] | Lenght max [m] |
|-----------------|----------------|
| 10 K | 2000 |
| 20 K | 2000 |
| 50 K | 1000 (*) |
| 100 K | 650 (*) |
| 125 K | 500 (*) |
| 250 K | 250 (*) |
| 500 K | 100 (*) |
| 800 K | 50 (*) |
| 1000 K | 25 (*) |

www.ADFweb.com

(*) Link distance is limited by signaling rate as specified by the CAN bus specification to bus arbitration.

Figure 1: Function scheme and Baud rate table for "F" series

“FSX” SERIES

Bridges and repeaters for CANbus, CANopen, DeviceNet, J1939, CAN2.0A, CAN2.0B:

HD67117FSX CANopen to Optic Fiber Repeater;

HD67180FSX DeviceNet to Optic Fiber Repeater;

HD67181FSX CAN to Optic Fiber Repeater for generic use (Standard and Extended Protocol);

HD67182FSX J1939 to Optic Fiber Repeater.

These series of device use the large bandwidth of optics fibres for extend the CAN bus link.

Function scheme:

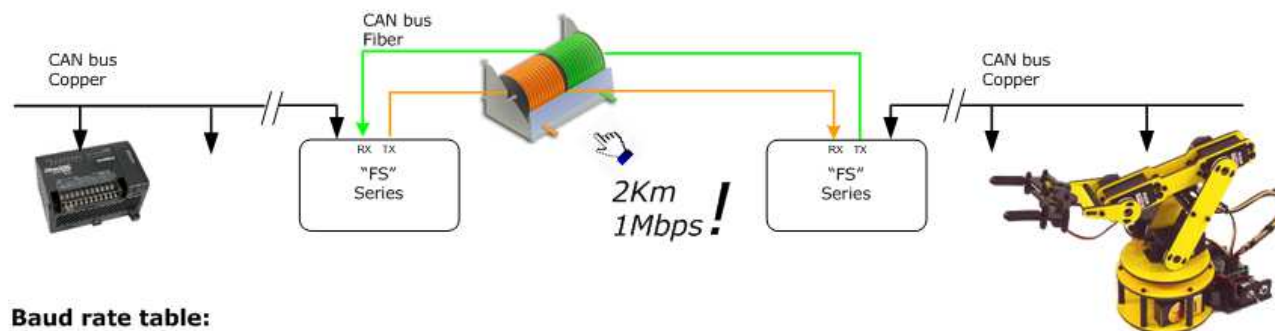

Baud rate table:

Copper Side:

| Baud rate [bps] | Lenght max [m] |
|-----------------|----------------|
| 10 K | 5000 |
| 20 K | 2500 |
| 50 K | 1000 |
| 100 K | 650 |
| 125 K | 500 |
| 250 K | 250 |
| 500 K | 100 |
| 800 K | 50 |
| 1000 K | 25 |

Fiber Optic Side: (*)

| Baud rate [bps] | Lenght max [m] |
|-----------------|----------------|
| 10 K | 2000 |
| 20 K | 2000 |
| 50 K | 2000 |
| 100 K | 2000 |
| 125 K | 2000 |
| 250 K | 2000 |
| 500 K | 2000 |
| 800 K | 2000 |
| 1000 K | 2000 |

www.ADFweb.com

(*) Fiber optic 62.5/125µm

Figure 2: Function scheme and Baud rate table for “FSX” series

CONNECTION SCHEME:

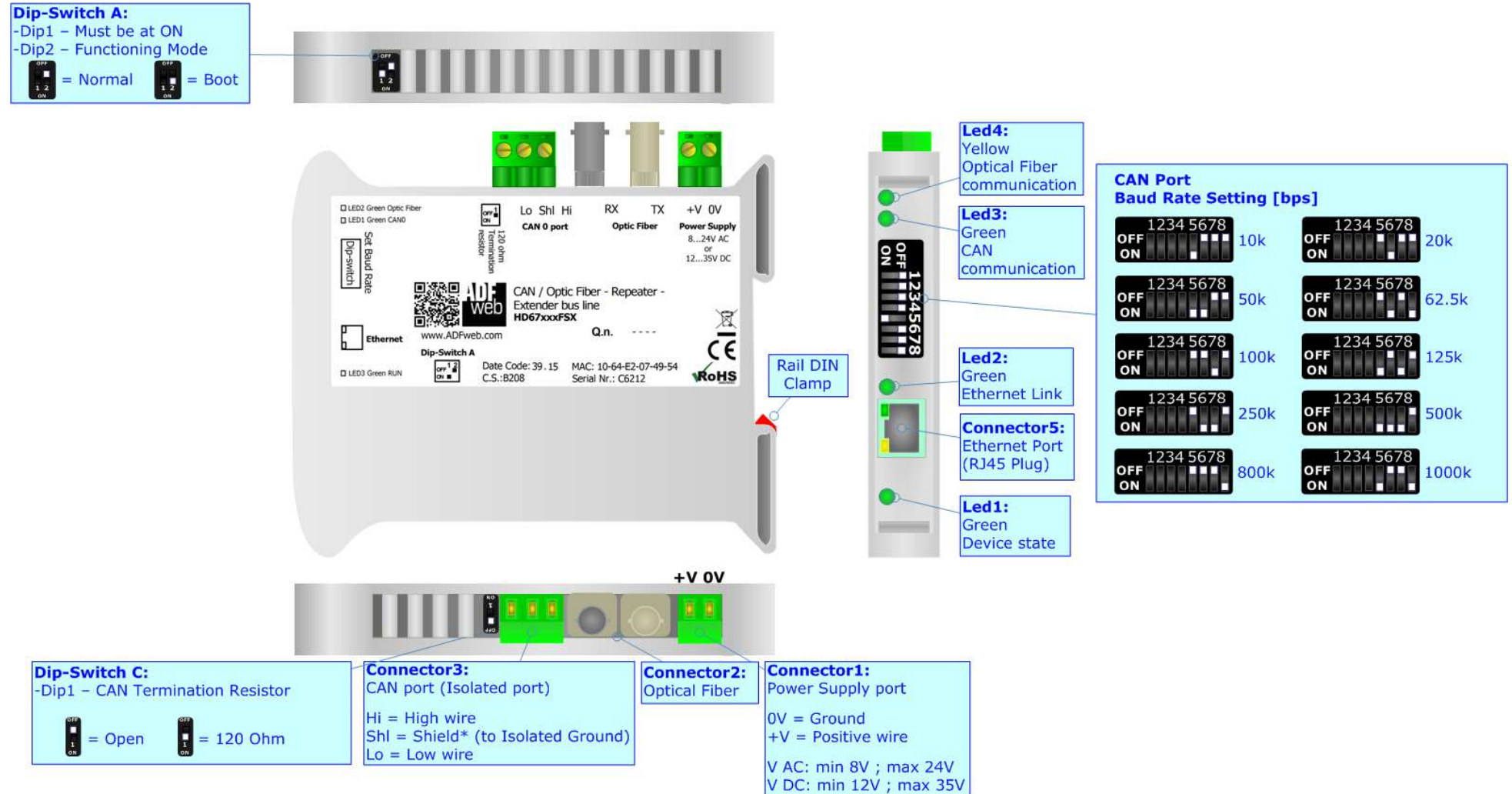

Figure 3b: Connection scheme for HD67117/180/181/182FSX

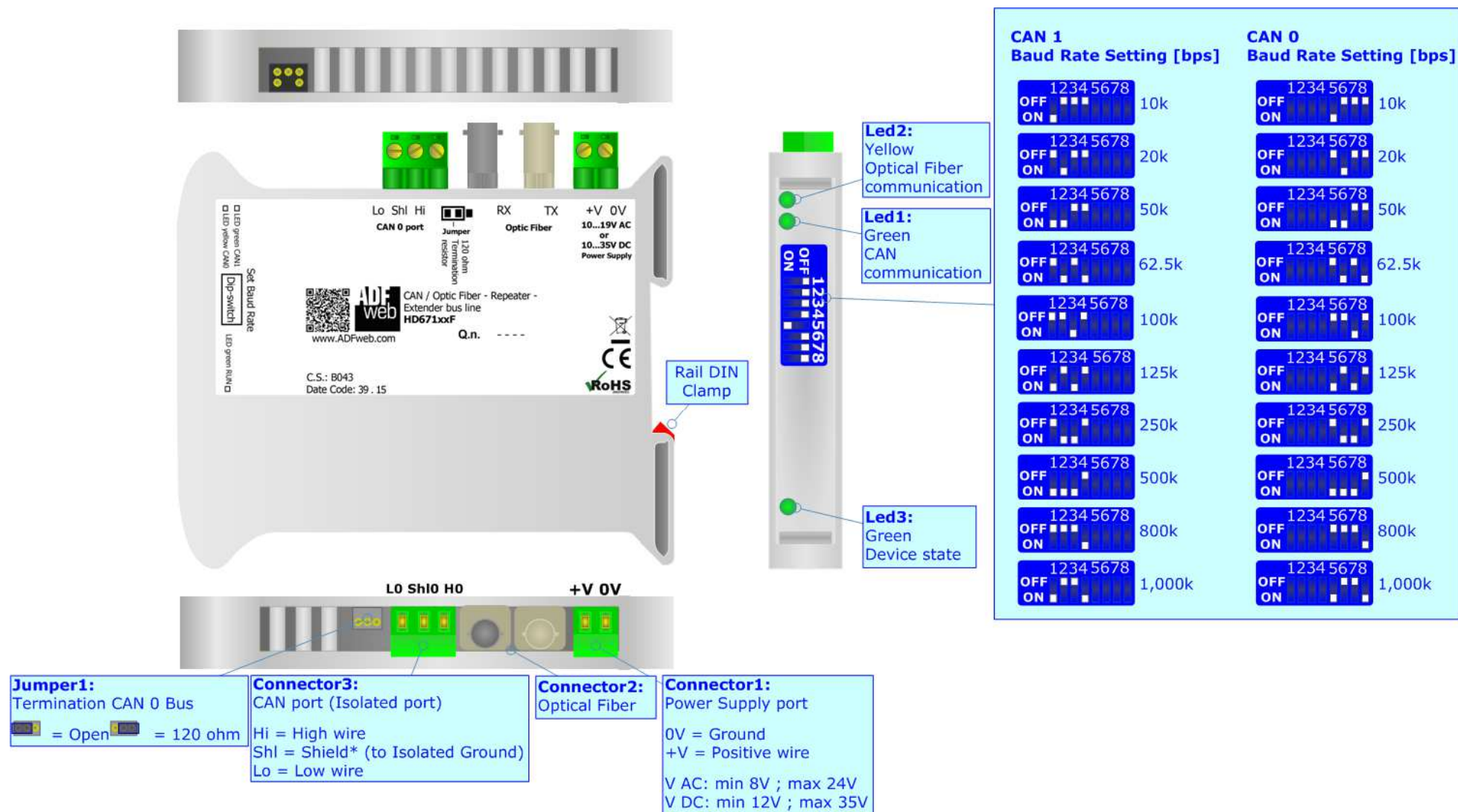

Figure 3b: Connection scheme for HD67117/180/181/182F

POWER SUPPLY:

The devices can be powered at 8...24V AC and 12...35V DC (FSX series) or at 10...19V AC and 10...19V DC (F series). For more details see the two tables below.

| | VAC | | VDC | |
|-------------------|------------|------------|------------|------------|
| | Vmin | Vmax | Vmin | Vmax |
| Series F | 10V | 19V | 10V | 35V |
| Series FSX | 8V | 24V | 12V | 35V |

Consumption at 24V DC:

| Device | Consumption [W/VA] |
|------------|--------------------|
| Series F | 4 |
| Series FSX | 3.5 |

Connector1:
Power Supply
0V = Ground
+V = Positive wire
V AC: min 10V ; max 19V
V DC: min 10V ; max 35V

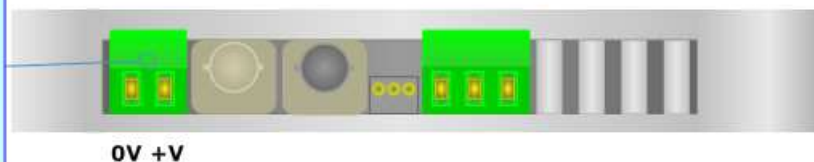

Connector1:
Power Supply port
0V = Ground
+V = Positive wire
V AC: min 8V ; max 24V
V DC: min 12V ; max 35V



Caution: Not reverse the polarity power

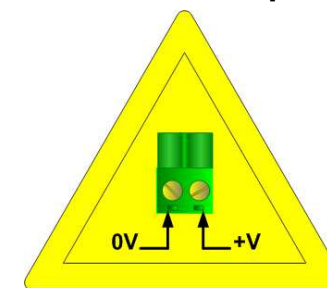

HD671xxF/FSX

FUNCTION MODES (FSX series):Hardware version with Dip-Switches

The device has got two function modes depending on the position of the 'Dip2 of Dip-Switch A':

- The first, with 'Dip2 of Dip-Switch A' at "OFF" position, is used for the normal working of the device.
- The second, with 'Dip2 of Dip-Switch A' at "ON" position, is used for uploading the Project and/or Firmware.

For the operations to follow for the updating, see 'UPDATE DEVICE' section.

According to the functioning mode, the LEDs will have specific functions, see 'LEDS' section.

**Warning:**

Dip1 of 'Dip-Switch A' must be at ON position to work even if the Ethernet cable is not inserted.

Hardware version with Jumpers

The device has got two functions mode depending of the position of the 'Boot Jumper':

- The first, with 'Boot Jumper' not inserted, is used for the normal working of the device.
- The second, with 'Boot Jumper' inserted, is used for upload the Firmware.

LEDS (F series):

The devices have got three green LEDs that are used to give information of the functioning status. The various meanings of the LEDs are described in the table below.

| LED | Normal Mode | Boot Mode |
|--------------------------------------|--|-----------------------------------|
| 1: CAN Communication (green) | Changes State when a CAN message arrives | OFF |
| 2: Optic Fiber Communication (green) | Changes state when a Optic Fiber message arrives | OFF |
| 3: Device State (green) | Blinks slowly (~1Hz) | Blinks quickly: Boot state |



LEDS (FSX series, Hardware version with Dip-Switches):

The devices have got four green LEDs that are used to give information of the functioning status. The various meanings of the LEDs are described in the table below.

| LED | Normal Mode | Boot Mode |
|--------------------------------------|--|--|
| 1: Device State (green) | Blinks slowly (~1Hz) | Blinks quickly: Boot state |
| 2: Ethernet Link (green) | ON: Ethernet cable connected OFF: Ethernet cable disconnected | ON: Ethernet cable connected OFF: Ethernet cable disconnected |
| 3: CAN communication (green) | Changes state when a CAN message arrives | Blinks quickly: Boot state |
| 4: Optic Fiber Communication (green) | Changes state when a Optic Fiber message arrives | Blinks quickly: Boot state |



CAN:

For terminating the CAN line with a 120Ω resistor it is necessary that the Dip1 of 'Dip-Switch C' is at ON position (for the FSX serie) and that the Jumper1 is at "120Ohm" position (for the F serie).

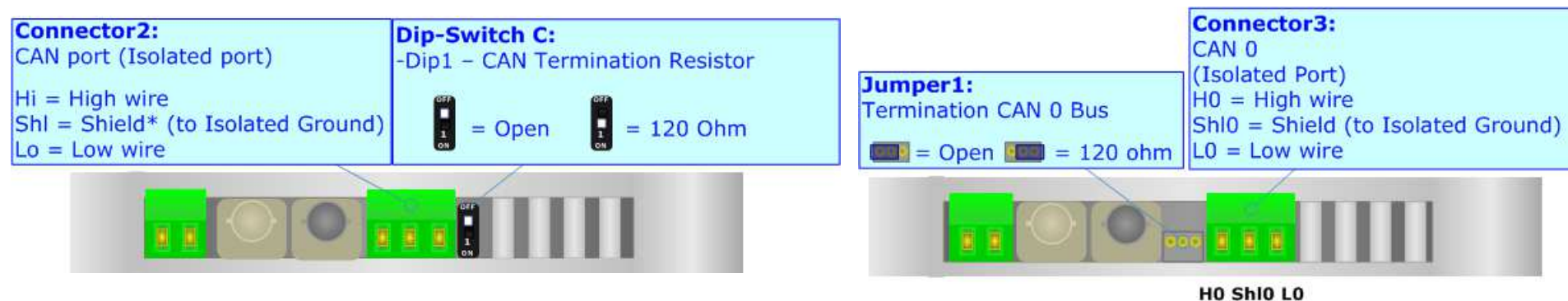

Cable characteristics:

| | | |
|-----------------------|------------------------|-----------------------|
| DC parameter: | Impedance | 70 Ohm/m |
| AC parameters: | Impedance | 120 Ohm/m |
| | Delay | 5 ns/m |
| Length | Baud Rate [bps] | Length MAX [m] |
| | 10 K | 5000 |
| | 20 K | 2500 |
| | 50 K | 1000 |
| | 100 K | 650 |
| | 125 K | 500 |
| | 250 K | 250 |
| | 500 K | 100 |
| | 800 K | 50 |
| | 1000 K | 25 |

SET SWITCH BAUD RATE FOR “F” SERIES:

The switches for setting the CAN0 baud rate and CAN1 on the front panel of the device:

Dip n° 1, 2, 3, 4 CAN1 setting;

Dip n° 5, 6, 7, 8 CAN0 setting.

| Speed CAN1 BPS | Dip 1 | Dip 2 | Dip 3 | Dip 4 |
|----------------|-------|-------|-------|-------|
| Speed CAN0 BPS | Dip 5 | Dip 6 | Dip 7 | Dip 8 |
| 10K | ON | OFF | OFF | OFF |
| 20K | OFF | ON | OFF | OFF |
| 50K | ON | ON | OFF | OFF |
| 62.5K | OFF | ON | OFF | ON |
| 100K | OFF | OFF | ON | OFF |
| 125K | ON | OFF | ON | OFF |
| 250K | OFF | ON | ON | OFF |
| 500K | ON | ON | ON | OFF |
| 800K | OFF | OFF | OFF | ON |
| 1000K | ON | OFF | OFF | ON |

SET SWITCH BAUD RATE FOR “FSX” SERIES:

The switches for setting the CAN0 baud rate on the front panel of the device:

Dip n° 5, 6, 7, 8 CAN0 setting.

| Speed CAN0 BPS | Dip 5 | Dip 6 | Dip 7 | Dip 8 |
|----------------|-------|-------|-------|-------|
| 10K | ON | OFF | OFF | OFF |
| 20K | OFF | ON | OFF | OFF |
| 50K | ON | ON | OFF | OFF |
| 62.5K | OFF | ON | OFF | ON |
| 100K | OFF | OFF | ON | OFF |
| 125K | ON | OFF | ON | OFF |
| 250K | OFF | ON | ON | OFF |
| 500K | ON | ON | ON | OFF |
| 800K | OFF | OFF | OFF | ON |
| 1000K | ON | OFF | OFF | ON |

ETHERNET (FSX serie, Hardware version with Dip-Switches):

The Ethernet port is used for the firmware updating of the HD671xxFSX.

The Ethernet connection must be made using Connector5 of HD671xxFSX with at least a Category 5E cable. The maximum length of the cable should not exceed 100m. The cable has to conform to the T568 norms relative to connections in cat.5 up to 100 Mbps. To connect the device to a Hub/Switch the use of a straight cable is recommended. To connect the device to a PC/PLC/other the use of a cross cable is recommended.

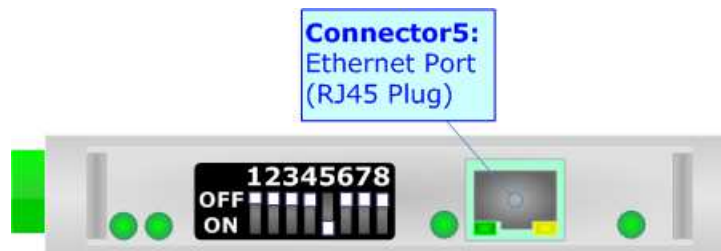

RS232 (FSX serie, Hardware version with Jumpers):

The connection from RS232 socket to a serial port (example one from a personal computer), must be made with a Null Modem cable (a serial cable where the pins 2 and 3 are crossed). It is recommended that the RS232C Cable not exceed 15 meters.

The serial port is used for programming the device.

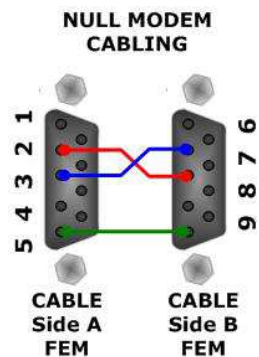

USE OF COMPOSITOR SW67FSX (only for FSX serie):

To configure the Converter, use the available software that runs with Windows called SW67507. It is downloadable on the site www.adfweb.com and its operation is described in this document. *(This manual is referenced to the last version of the software present on our web site)*. The software works with MSWindows (XP, Vista, Seven, 8, 10; 32/64bit).

When launching the SW67FSX, the window below appears (Fig. 4).

 **Note:**
The minimum version of the configuration software must be the 2.000.

 **Note:**
It is necessary to have installed .Net Framework 4.

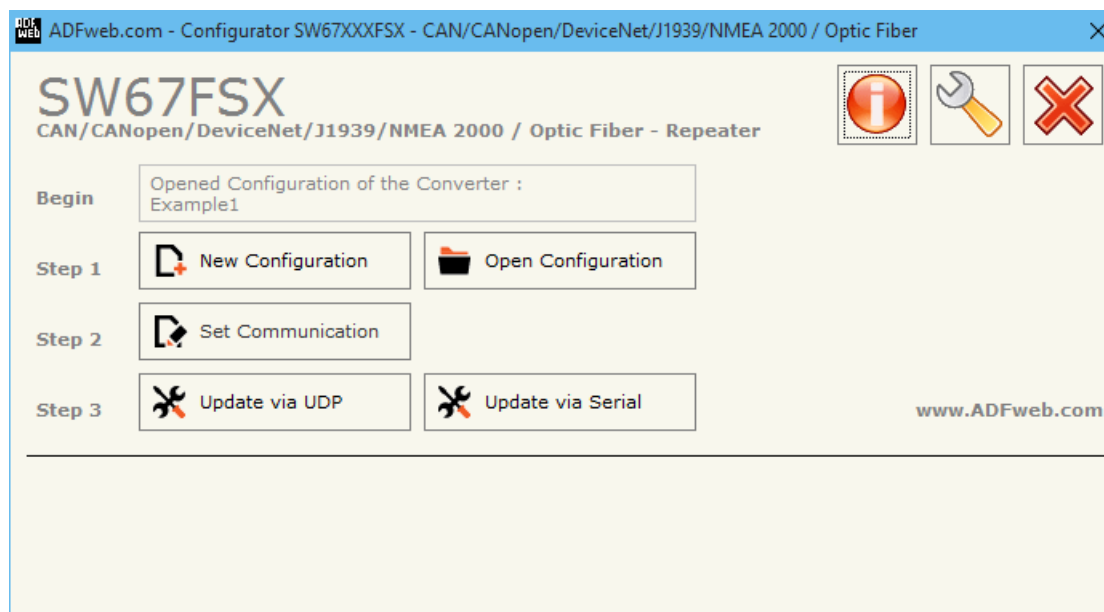
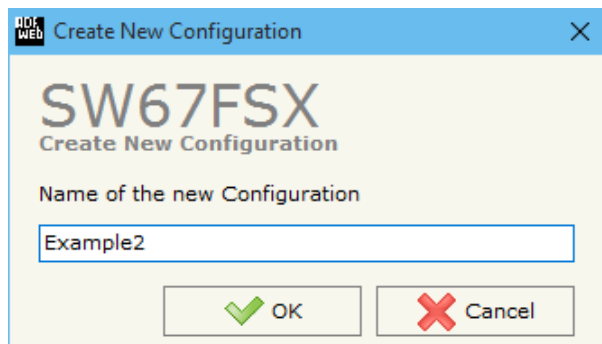

Figure 4: Main window for SW67FSX

NEW CONFIGURATION / OPEN CONFIGURATION:

The “**New Configuration**” button creates the folder which contains the entire device’s configuration.



A device’s configuration can also be imported or exported:

- To clone the configurations of a programmable “CAN/CANopen/DeviceNet/J1939/NMEA 2000 / Optic Fiber – Repeater” in order to configure another device in the same manner, it is necessary to maintain the folder and all its contents;
- To clone a project in order to obtain a different version of the project, it is sufficient to duplicate the project folder with another name and open the new folder with the button “**Open Configuration**”.

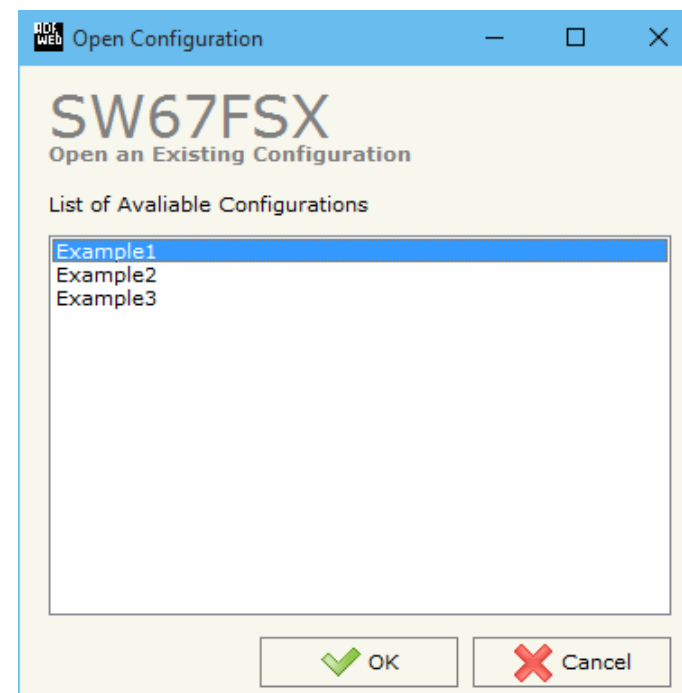

SOFTWARE OPTIONS:

By pressing the “**Settings**” () button there is the possibility to change the language of the software and check the updatings for the compositor.

In the section “Language” it is possible to change the language of the software.

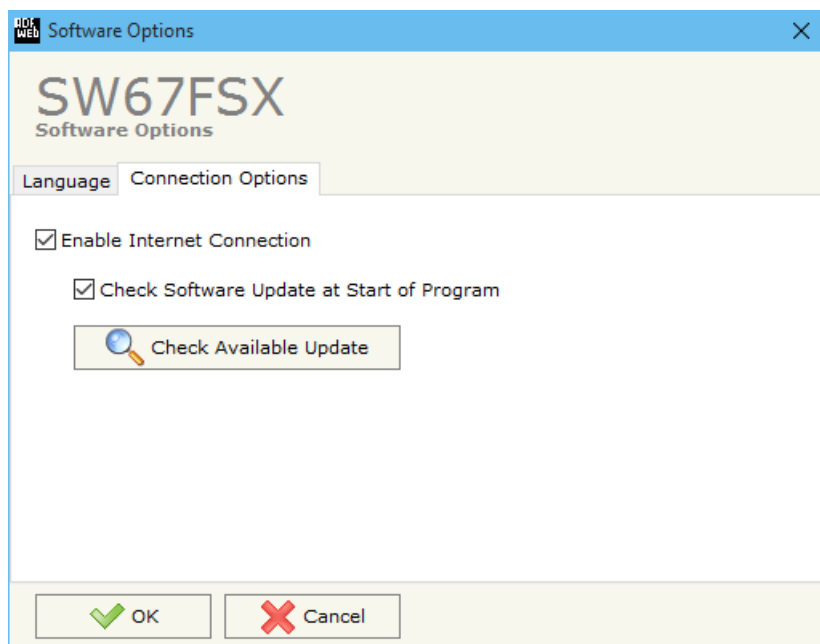

In the section “Connection Options”, it is possible to check if there are some updatings of the software compositor in ADFweb.com website. Checking the option “**Check Software Update at Start of Program**”, the SW67FSX check automatically if there are updatings when it is launched.

SET COMMUNICATION:

This section defines the parameters of Ethernet port for the hardware version with the Dip-Switches. The Ethernet port is used for the firmware updating in case of new releases.

By pressing the "Set Communication" button from the main window for SW67FSX (Fig. 4) the window "Set Communication" appears (Fig. 5).

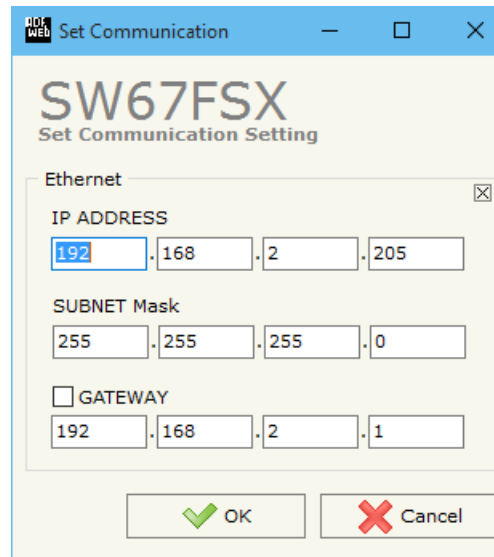

The screenshot shows a web-based configuration window titled "Set Communication" for the device "SW67FSX". The window is divided into an "Ethernet" section, which is currently expanded. Within this section, there are three rows of input fields for IP configuration. The first row is labeled "IP ADDRESS" and contains four boxes with the values 192, 168, 2, and 205. The second row is labeled "SUBNET Mask" and contains four boxes with the values 255, 255, 255, and 0. The third row is labeled "GATEWAY" and has a checkbox to its left that is checked; the input boxes contain the values 192, 168, 2, and 1. At the bottom of the window, there are two buttons: "OK" with a green checkmark icon and "Cancel" with a red X icon.

Figure 5: "Set Communication" window

The means of the fields for "Ethernet" are:

- ➔ In the field "IP ADDRESS", the IP address of the Ethernet side is defined;
- ➔ In the field "SUBNET Mask", SubNet Mask of the Ethernet network is defined;
- ➔ If the field "GATEWAY" is checked, insert the default gateway that you want to use. This feature can be enabled or disabled pressing the Check Box field. This feature is used for programming the device remotely.

UPDATE VIA SERIAL (FSX serie, only for the Hardware version with Jumpers):

By pressing the **Update Device** button it is possible to load the firmware into the device using the RS232 port.

In order to load the parameters or update the firmware in the device, follow these instructions:

- Turn off the Device;
- Connect the RS232 cable from your PC to the Converter;
- Insert the Boot Jumper in the Boot Position;
- Select the **COM port** and press the **Connect** button;
- Turn on the device;
- Check the "Device state" Led. It must blink quickly;
- Press the **Next** button;
- Select which operations you want to do.
- Press the **Execute update firmware** button to start the upload;
- When all the operations are "OK" turn off the device;
- Remove the Boot Jumper;
- Disconnect the RS232 cable;
- Turn on the device.

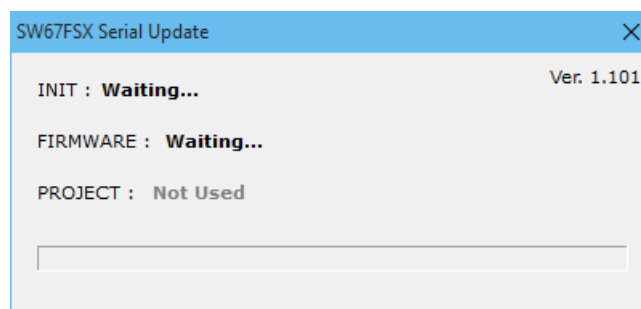
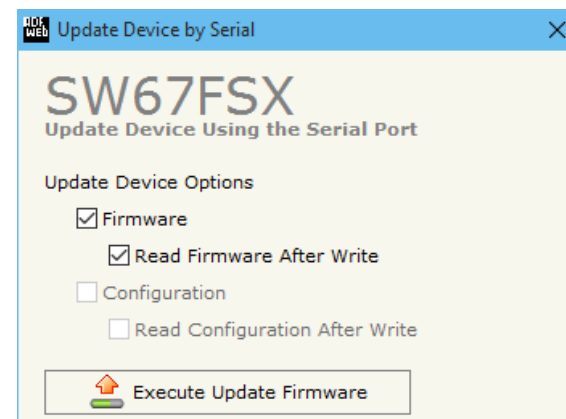
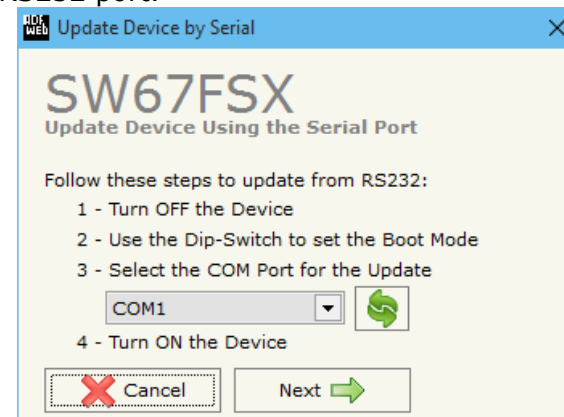

Figure 6: "Update via Serial" windows

UPDATE VIA UDP (FSX serie, only for the Hardware version with Dip-Switches):

By pressing the **Update Device** button, it is possible to load the created Configuration into the device; and also the Firmware, if necessary.

If you don't know the actual IP address of the device you have to use this procedure:

- Turn off the Device;
- Put Dip2 of 'Dip-Switch A' in ON position;
- Turn on the device
- Connect the Ethernet cable;
- Insert the IP **"192.168.2.205"**;
- Press the **"Ping"** button, "Device Found! must appear";
- Press the **"Next"** button;
- Select which operations you want to do;
- Press the **"Execute update firmware"** button to start the upload;
- When all the operations are "OK" turn off the Device;
- Put Dip2 of 'Dip-Switch A' in OFF position;
- Turn on the device.

At this point the configuration/firmware on the device is correctly updated.

If you know the actual IP address of the device, you have to use this procedure:

- Turn on the Device with the Ethernet cable inserted;
- Insert the actual IP of the Converter;
- Press the **"Ping"** button, must appear "Device Found!";
- Press the **"Next"** button;
- Select which operations you want to do;
- Press the **"Execute update firmware"** button to start the upload;
- When all the operations are "OK" the device automatically goes at Normal Mode.

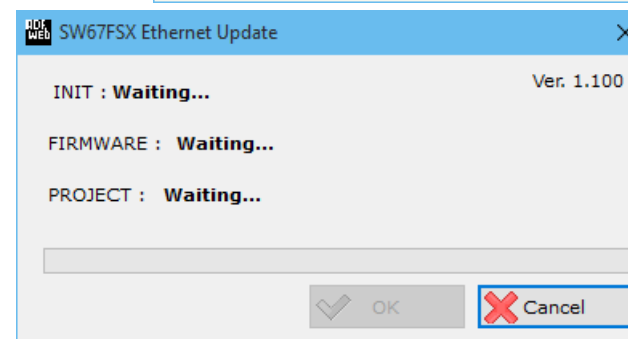
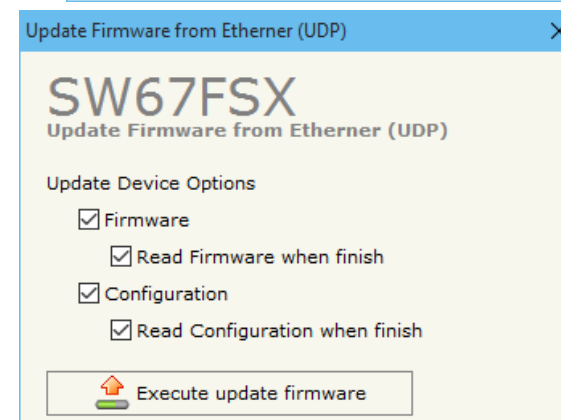
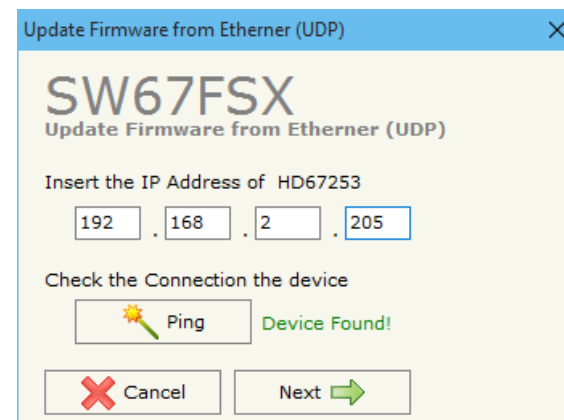



Figure 7: "Update via UDP" windows

 **Note:**
When you install a new version of the software, if it is the first time it is better you do the update of the Firmware in the HD671xxFSX device.

 **Note:**
When you receive the device, for the first time, you also have to update the Firmware in the HD671xxFSX device.

 **Warning:**
If Fig. 8 appears when you try to do the Update try these points before seeking assistance:

- Check if the serial COM port selected is the correct one;
- Check if the serial cable is connected between the PC and the device;
- Try to repeat the operations for the updating;
- If you are using a USB↔RS232 converter try with a native COM port or change the converter;
- Try to repeat the operations for the updating;
- Try with another PC;
- Try to restart the PC;
- Check the LAN settings;
- If you are using the program inside a Virtual Machine, try to use in the main Operating System;
- If you are using Windows Seven, Vista and 8 make sure that you have the administrator privileges;
- In case you have to program more than one device, using the "UDP Update", you have to cancel the ARP table every time you connect a new device on Ethernet. For do this you have to launch the "Command Prompt" and write the command "arp -d". Pay attention that with Windows Vista, Seven, 8 you have to launch the "Command Prompt" with Administrator Rights;
- Pay attention at Firewall lock.

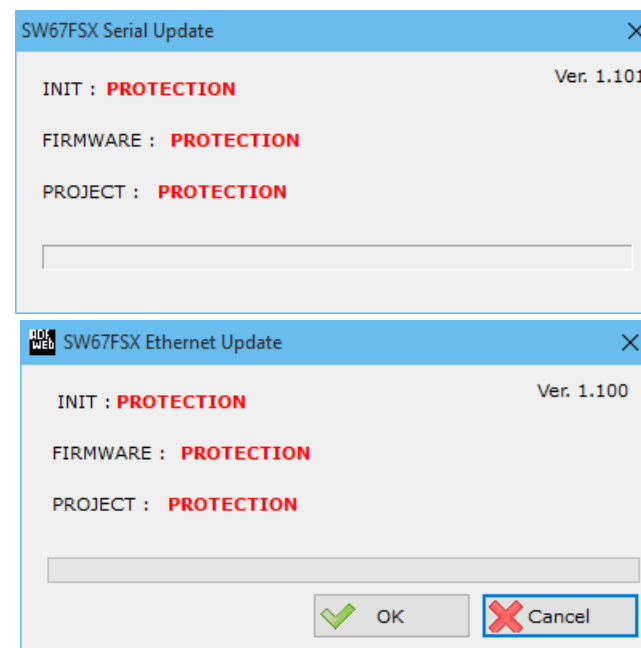

Figure 8: "Protection" windows

In the case of HD671xxFSX you have to use the software "SW67FSX": www.adfweb.com/download/filefold/SW67FSX.zip.

MECHANICAL DIMENSIONS:

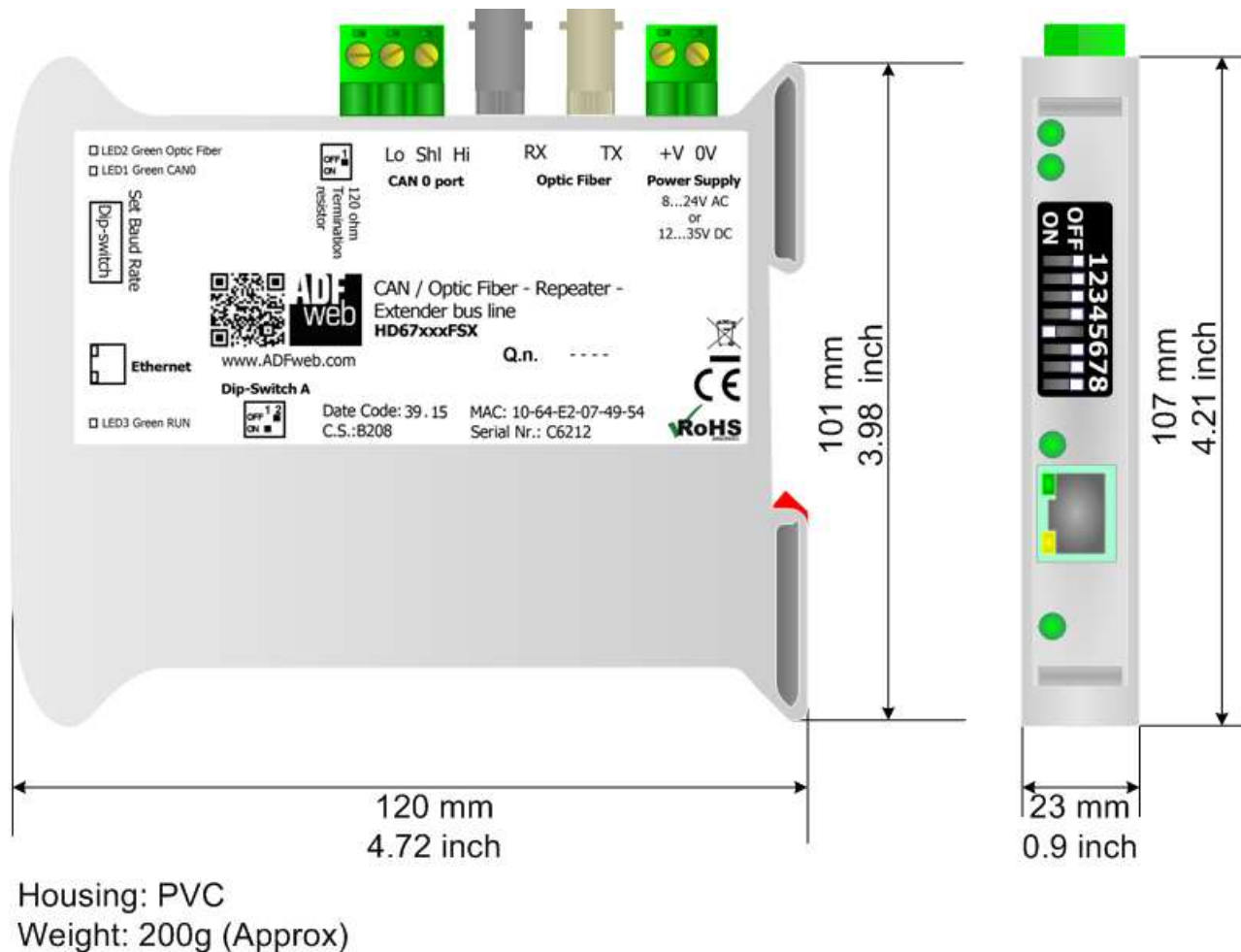

Figure 9a: Mechanical dimensions for HD671xxFSX

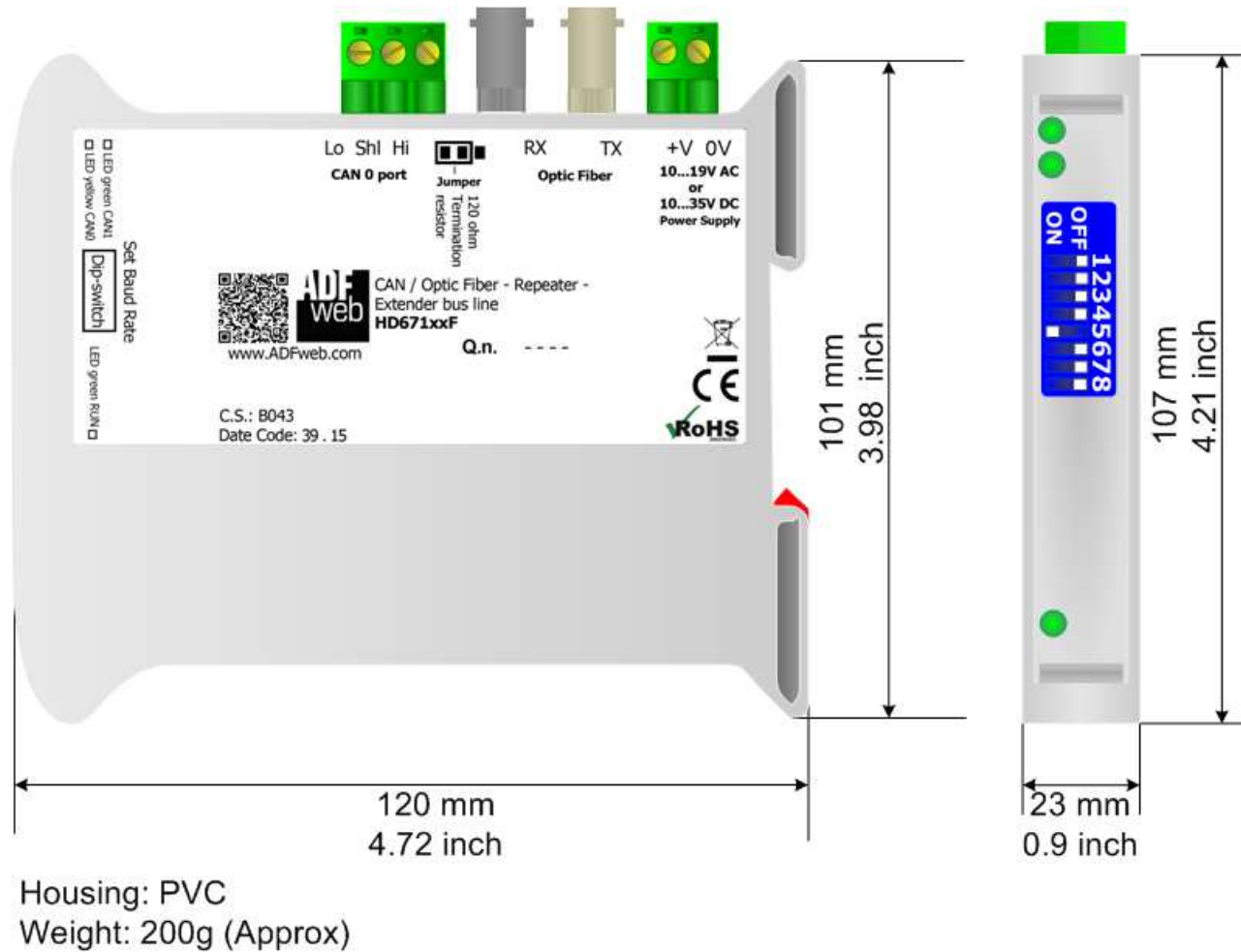

Figure 9b: Mechanical dimensions for HD671xxF

ORDER CODE:

| | | |
|-------------------------------|---|---|
| Order Code: HD67117FSX | - | CANopen / Optic Fiber – Repeater – Extender bus line (High Performance) |
| Order Code: HD67180FSX | - | DeviceNet / Optic Fiber – Repeater – Extender bus line (High Performance) |
| Order Code: HD67181FSX | - | CAN / Optic Fiber – Repeater – Extender bus line (High Performance) |
| Order Code: HD67182FSX | - | J1939 and NMEA 2000 / Optic Fiber – Repeater – Extender bus line (High Performance) |
| Order Code: HD67117F | - | CANopen / Optic Fiber – Repeater – Extender bus line |
| Order Code: HD67180F | - | DeviceNet / Optic Fiber – Repeater – Extender bus line |
| Order Code: HD67181F | - | CAN / Optic Fiber – Repeater – Extender bus line |
| Order Code: HD67182F | - | J1939 and NMEA 2000 / Optic Fiber – Repeater – Extender bus line |

ACCESSORIES:

| | | |
|----------------|---|--------------------------------------|
| AC34001 | - | Power Supply 220/12V AC 50/60Hz |
| AC34002 | - | Power Supply 110/12V AC 50/60Hz |
| AC34021 | - | Patch Cable Optic Fibres ST/ST 2Mts |
| AC34022 | - | Patch Cable Optic Fibres ST/ST 10Mts |

DISCLAIMER:

All technical content within this document can be modified without notice. The content of the document is a under continual renewal. For losses due to fire, earthquake, third party access or other accidents, or intentional or accidental abuse, misuse, or use under abnormal conditions repairs are charged to the user. ADFweb.com S.r.l. will not be liable for accidental loss of use or inability to use this product, such as loss of business income. ADFweb.com S.r.l. shall not be liable for consequences of improper use.

OTHER REGULATIONS AND STANDARDS:**WEEE INFORMATION**

Disposal of old electrical and electronic equipment (as in the European Union and other European countries with separate collection systems).

■ This symbol on the product or on its packaging indicates that this product may not be treated as household rubbish. Instead, it should be taken to an applicable collection point for the recycling of electrical and electronic equipment. If the product is disposed correctly, you will help prevent potential negative environmental factors and impact of human health, which could otherwise be caused by inappropriate disposal. The recycling of materials will help to conserve natural resources. For more information about recycling this product, please contact your local city office, your household waste disposal service or the shop where you purchased the product.

RESTRICTION OF HAZARDOUS SUBSTANCES DIRECTIVE

The device respects the 2002/95/EC Directive on the restriction of the use of certain hazardous substances in electrical and electronic equipment (commonly referred to as Restriction of Hazardous Substances Directive or RoHS).

CE MARKING

The product conforms with the essential requirements of the applicable EC directives.

WARRANTIES AND TECHNICAL SUPPORT:

For fast and easy technical support for your ADFweb.com SRL products, consult our internet support at www.adfweb.com. Otherwise contact us at the address support@adfweb.com

RETURN POLICY:

If while using your product you have any problem and you wish to exchange or repair it, please do the following:

- Obtain a Product Return Number (PRN) from our internet support at www.adfweb.com. Together with the request, you need to provide detailed information about the problem.
- Send the product to the address provided with the PRN, having prepaid the shipping costs (shipment costs billed to us will not be accepted).

If the product is within the warranty of twelve months, it will be repaired or exchanged and returned within three weeks. If the product is no longer under warranty, you will receive a repair estimate.



ADFweb.com S.r.l.
Via Strada Nuova, 17
IT-31010 Mareno di Piave
TREVISO (Italy)
Phone +39.0438.30.91.31
Fax +39.0438.49.20.99
www.adfweb.com

