

HD67702

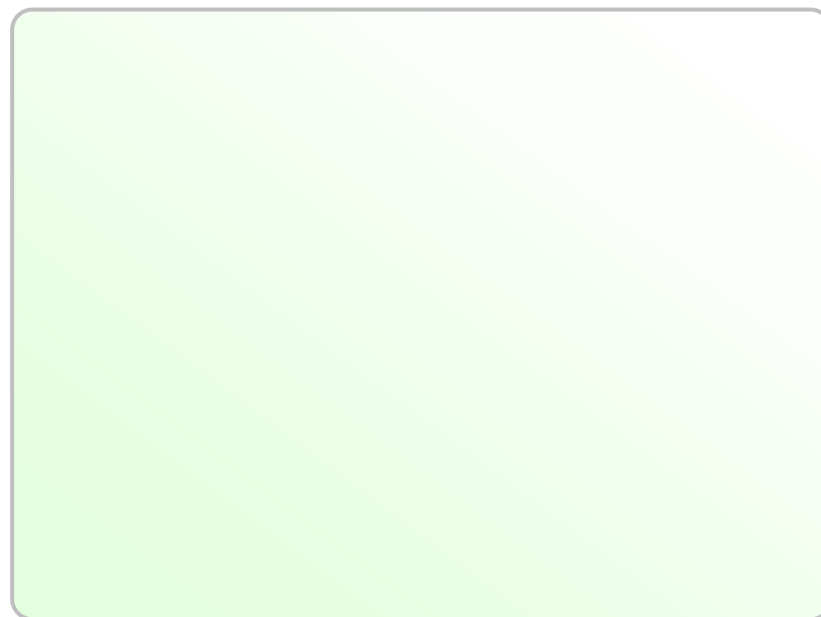
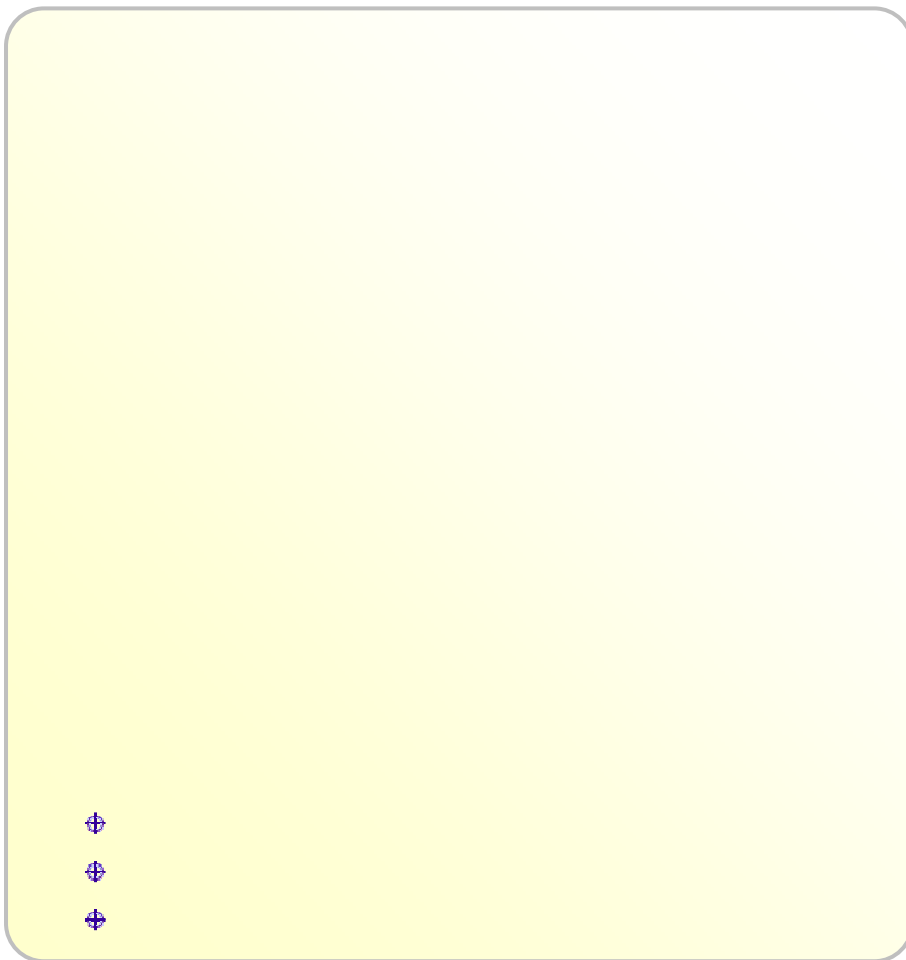

User Manual

INDEX:

	Page
INDEX	2
UPDATED DOCUMENTATION	2
REVISION LIST	2
WARNING	2
TRADEMARKS	2
SECURITY ALERT	3
EXAMPLES	4
CONNECTION SCHEME	6
CHARACTERISTICS	15
CONFIGURATION	15
POWER SUPPLY	16
FUNCTION MODES	17
LEDS	18
RS232	19
RS485	20
CAN	21
ETHERNET	22
USB	22
OPTICAL FIBER	23
I/O MODULE	24
USE OF COMPOSITOR SW67701	30
NEW/OPEN PROJECT	31
SOFTWARE OPTIONS	32
CONFIGURE DEVICES	33
MODBUS REGISTERS TABLE	36
UPDATE BY USB	38
UPDATE BY ETHERNET	39
MECHANICAL DIMENSIONS	41
ORDER CODE	42
ACCESSORIES	45
DISCLAIMER	46
OTHER REGULATIONS AND STANDARDS	46
WARRANTIES AND TECHNICAL SUPPORT	47
PRODUCTS AND RELATED DOCUMENTS	47

UPDATED DOCUMENTATION:

Dear customer, we thank you for your attention and we remind you that you need to check that the following document is:

- ✚ Updated
- ✚ Related to the product you own

To obtain the most recently updated document, note the “document code” that appears at the top right-hand corner of each page of this document.

With this “Document Code” go to web page www.adfweb.com/download/ and search for the corresponding code on the page. Click on the proper “Document Code” and download the updates.

REVISION LIST:

Revision	Date	Author	Chapter	Description
1.000	01/03/2013	Ff	All	First Released Version
1.001	17/02/2014	Ff	All	Revision
1.002	15/04/2015	Ff	All	Added new features
1.003	27/06/2016	Ff	All	Revision

WARNING:

ADFweb.com reserves the right to change information in this manual about our product without warning.
ADFweb.com is not responsible for any error this manual may contain.

TRADEMARKS:

All trademarks mentioned in this document belong to their respective owners.

SECURITY ALERT:**GENERAL INFORMATION**

To ensure safe operation, the device must be operated according to the instructions in the manual. When using the device, legal and safety regulation are required for each individual application. The same applies also when using accessories.

INTENDED USE

Machines and systems must be designed so the faulty conditions do not lead to a dangerous situation for the operator (i.e. independent limit switches, mechanical interlocks, etc.).

QUALIFIED PERSONNEL

The device can be used only by qualified personnel, strictly in accordance with the specifications. Qualified personnel are persons who are familiar with the installation, assembly, commissioning and operation of this equipment and who have appropriate qualifications for their job.

RESIDUAL RISKS

The device is state-of-the-art and is safe. The instruments can represent a potential hazard if they are inappropriately installed and operated by untrained personnel. These instructions refer to residual risks with the following symbol:



This symbol indicates that non-observance of the safety instructions is a danger for people that could lead to serious injury or death and / or the possibility of damage.

CE CONFORMITY

The declaration is made by our company. You can send an email to or give us a call if you need it.

EXAMPLE OF CONNECTION:

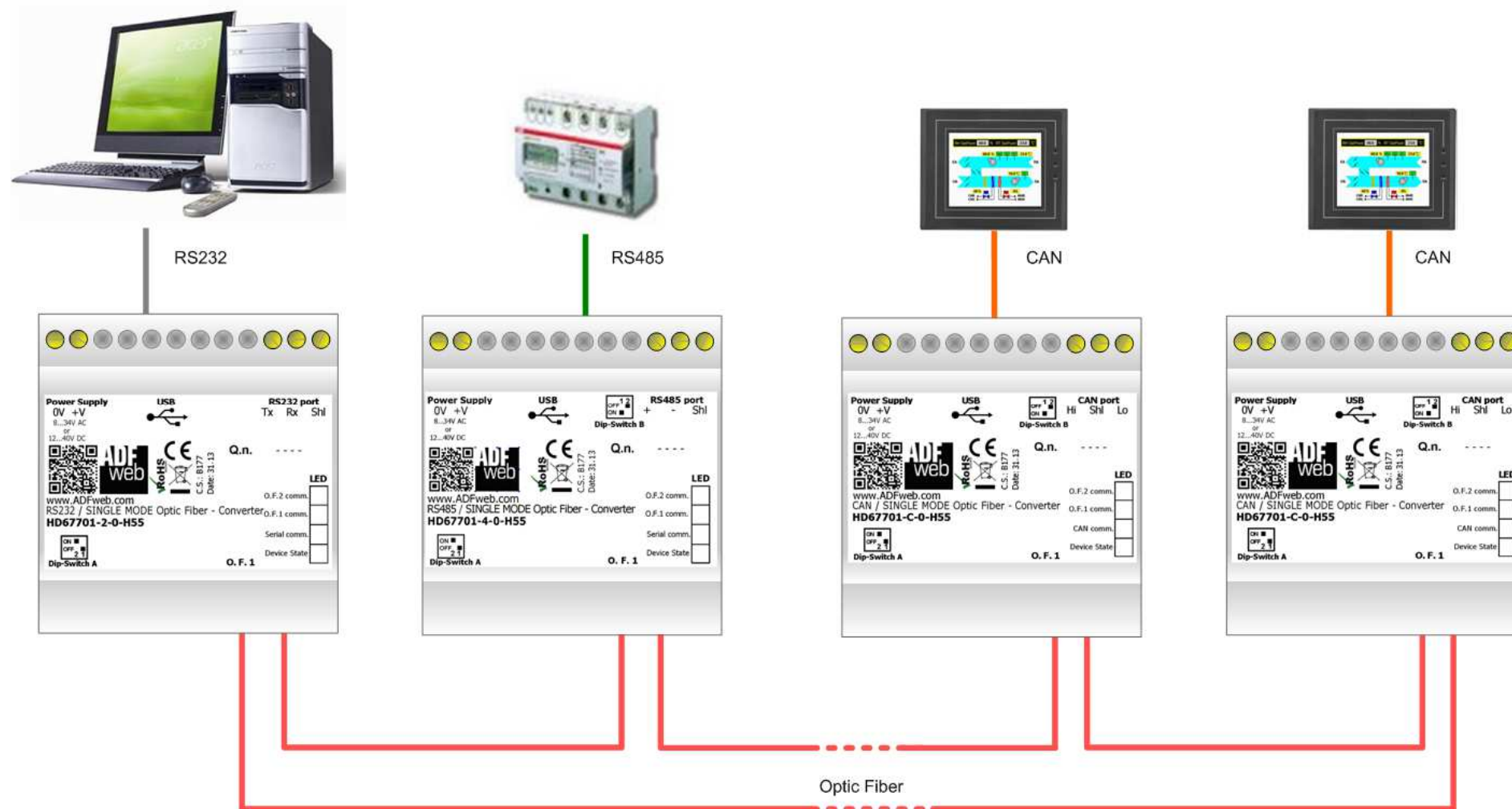



RS232



RS485



CAN



CAN

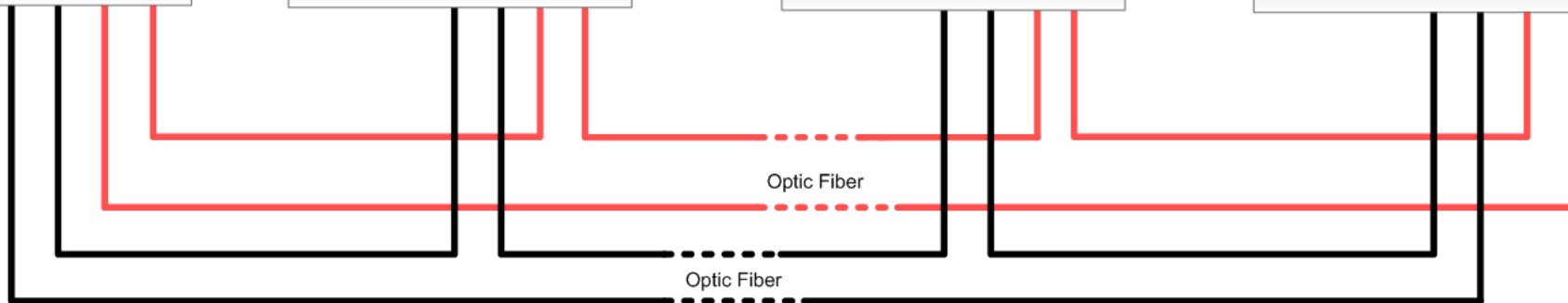
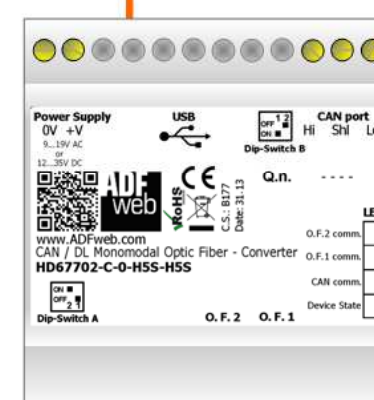
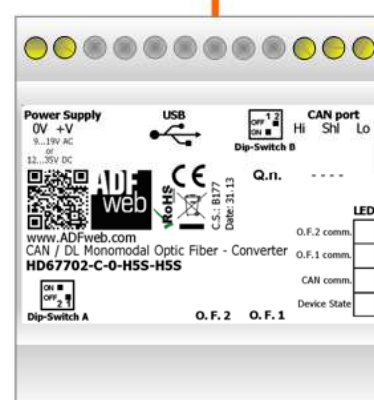
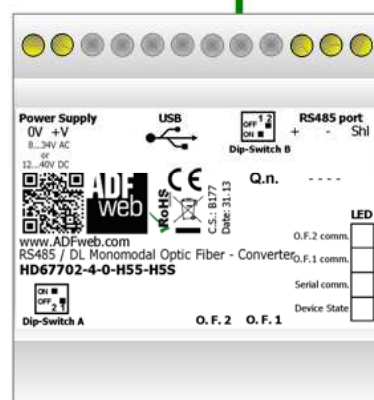
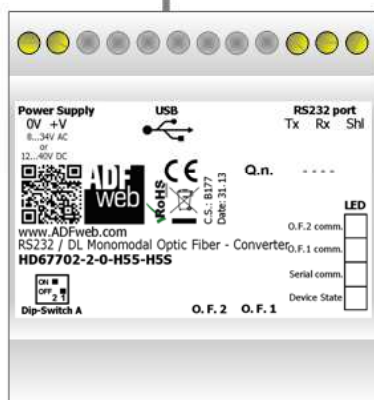

CONNECTION SCHEME:

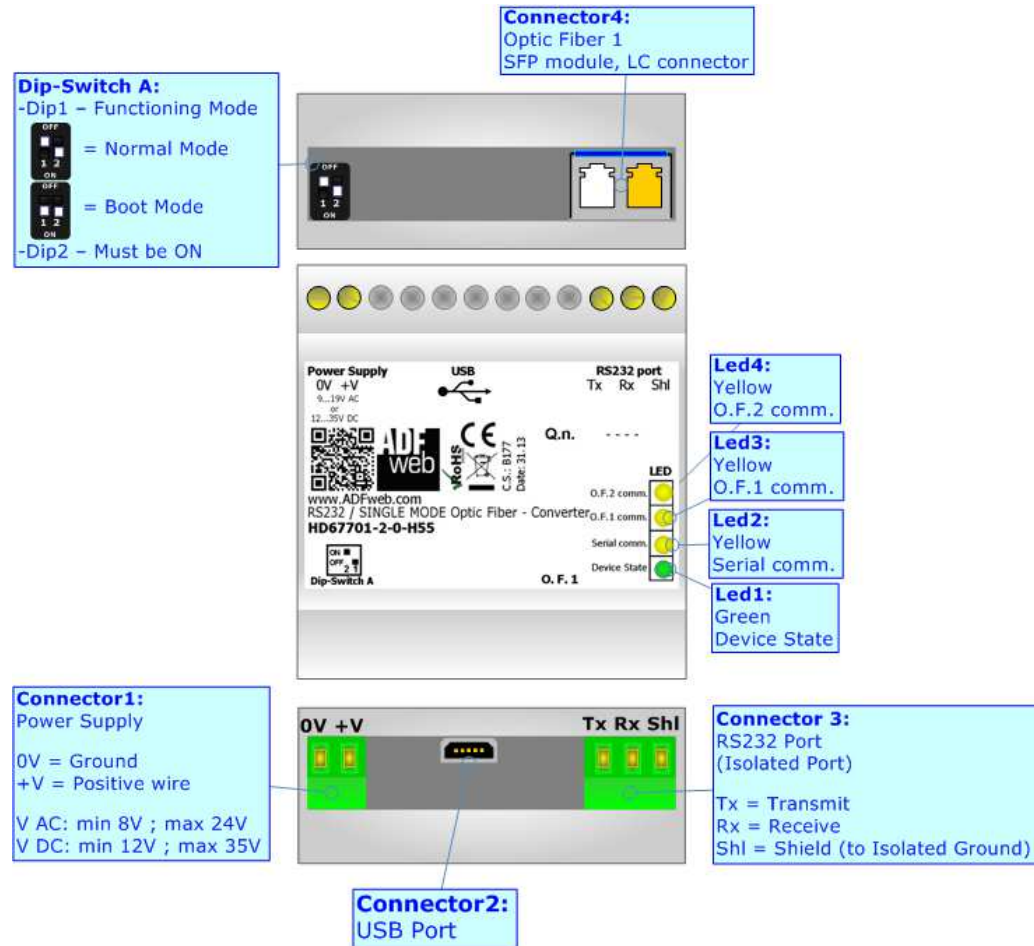

Figure 1a: Connection Scheme for HD67701-2-0-xxx

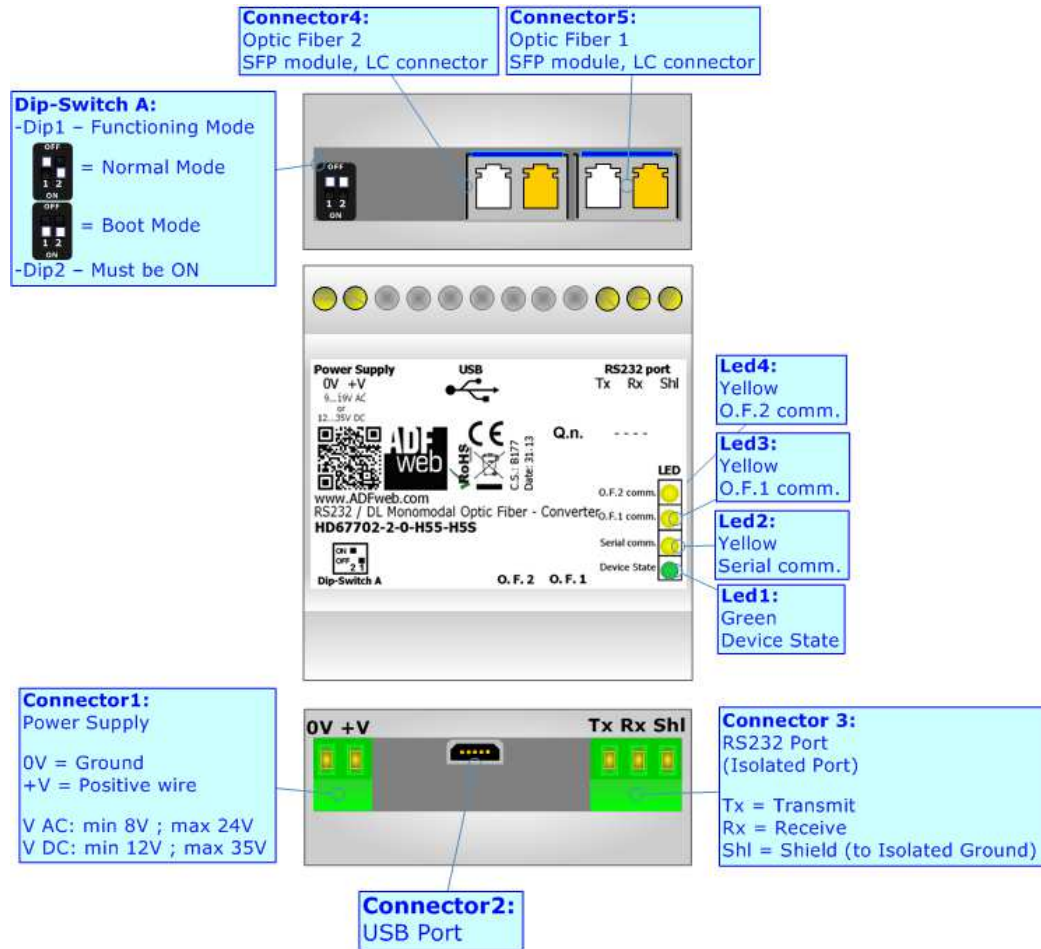

Figure 1b: Connection Scheme for HD67702-2-0-xxx-xxx

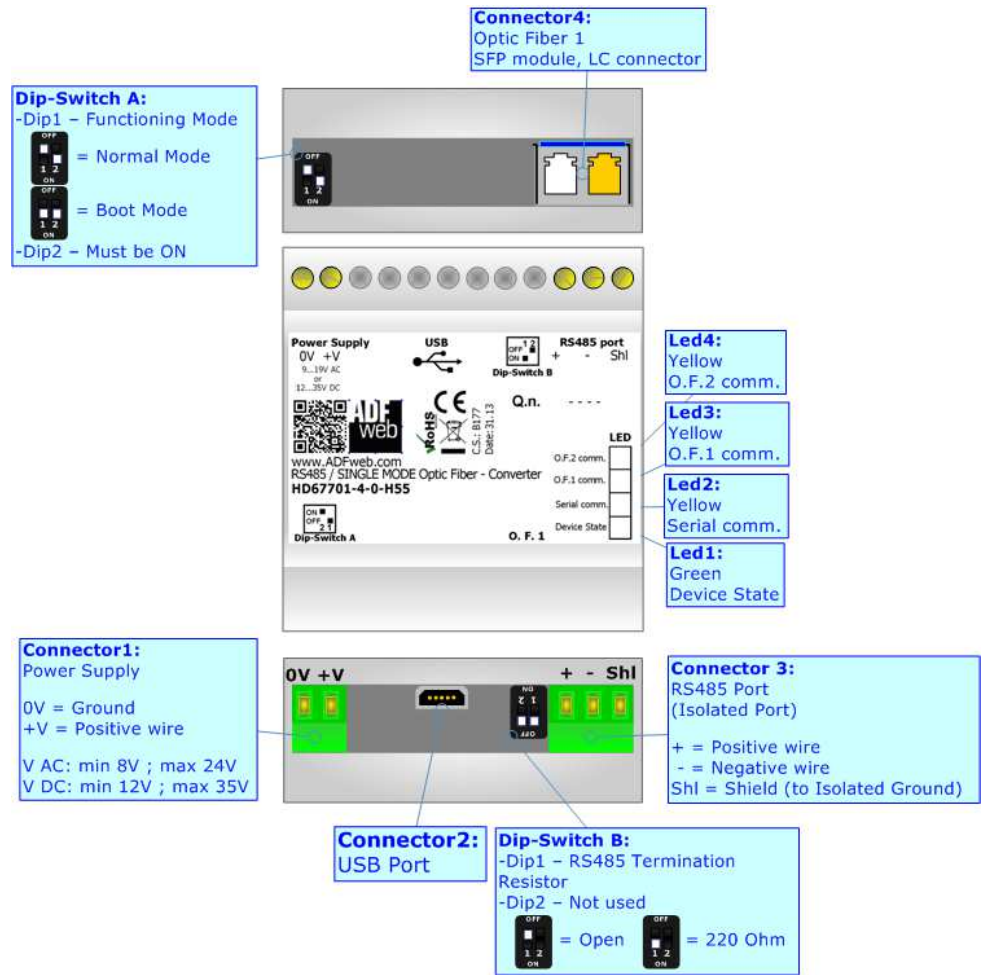

Figure 1c: Connection Scheme for HD67701-4-0-xxx

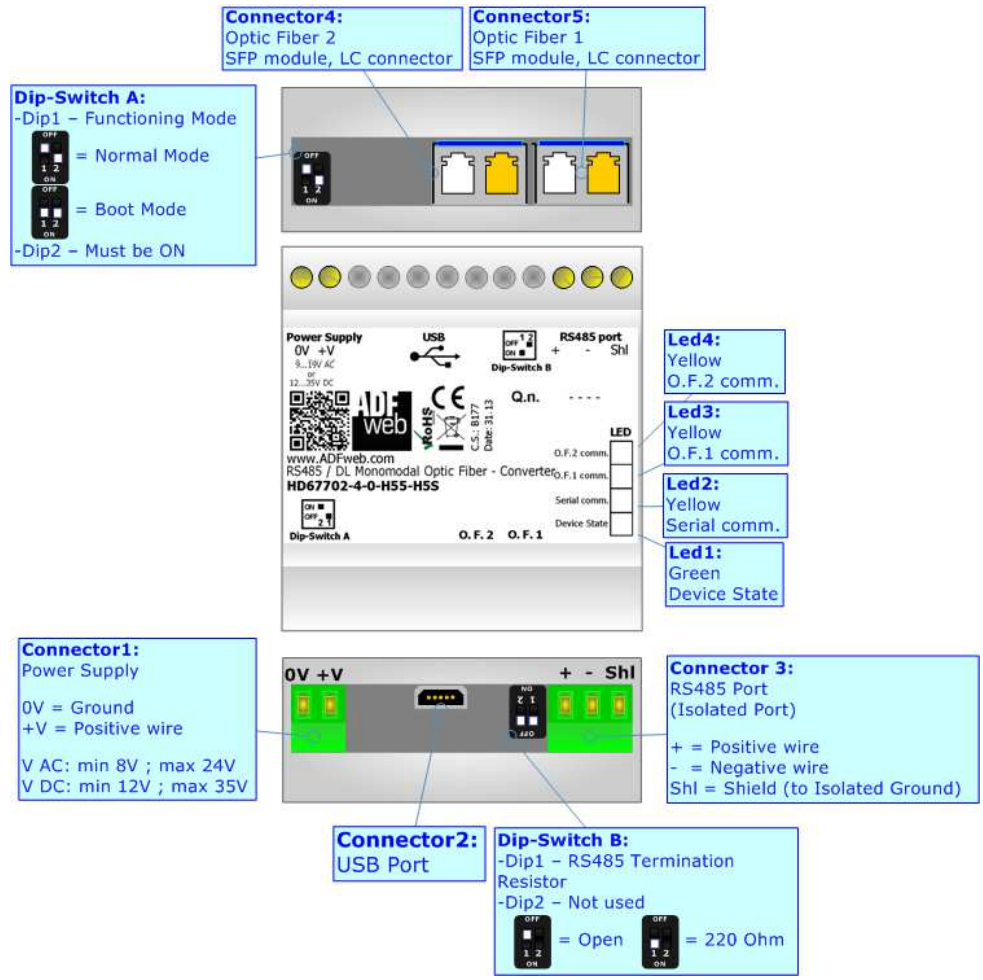

Figure 1d: Connection Scheme for HD67702-4-0-xxx-xxx

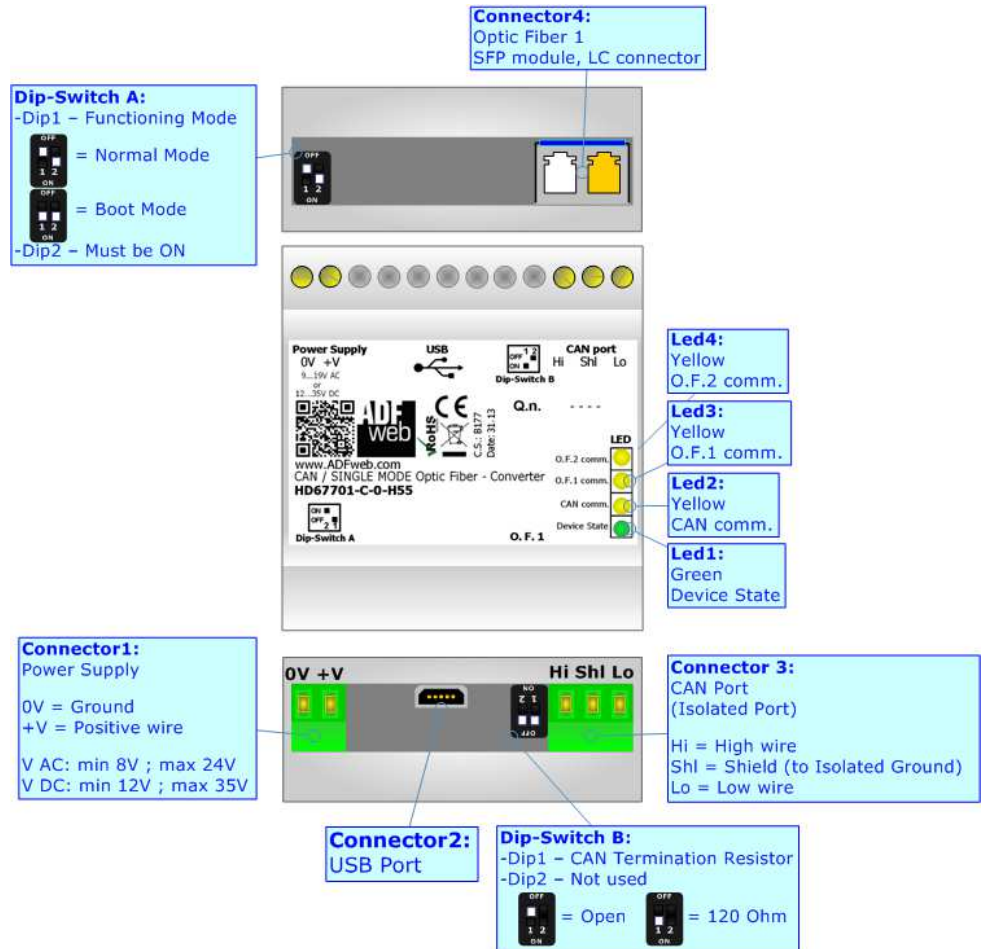

Figure 1e: Connection Scheme for HD67701-C-0-xxx

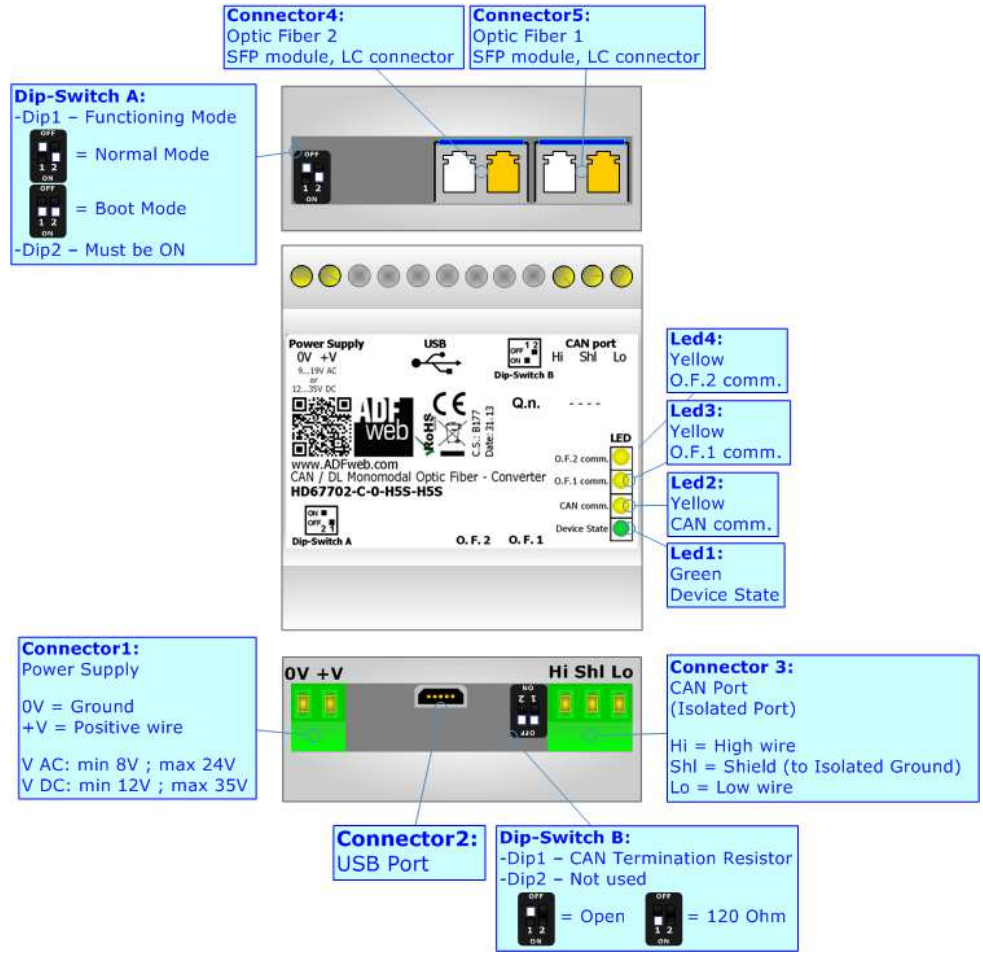

Figure 1f: Connection Scheme for HD67702-C-0-xxx-xxx

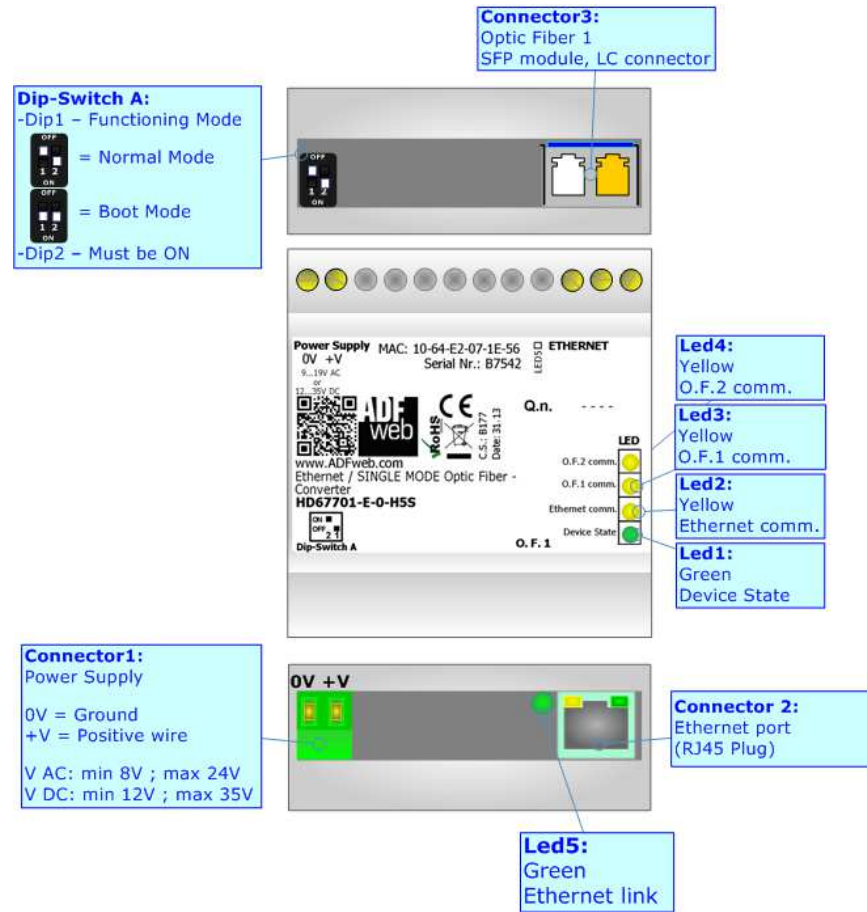

Figure 1g: Connection Scheme for HD67701-E-0-xxx

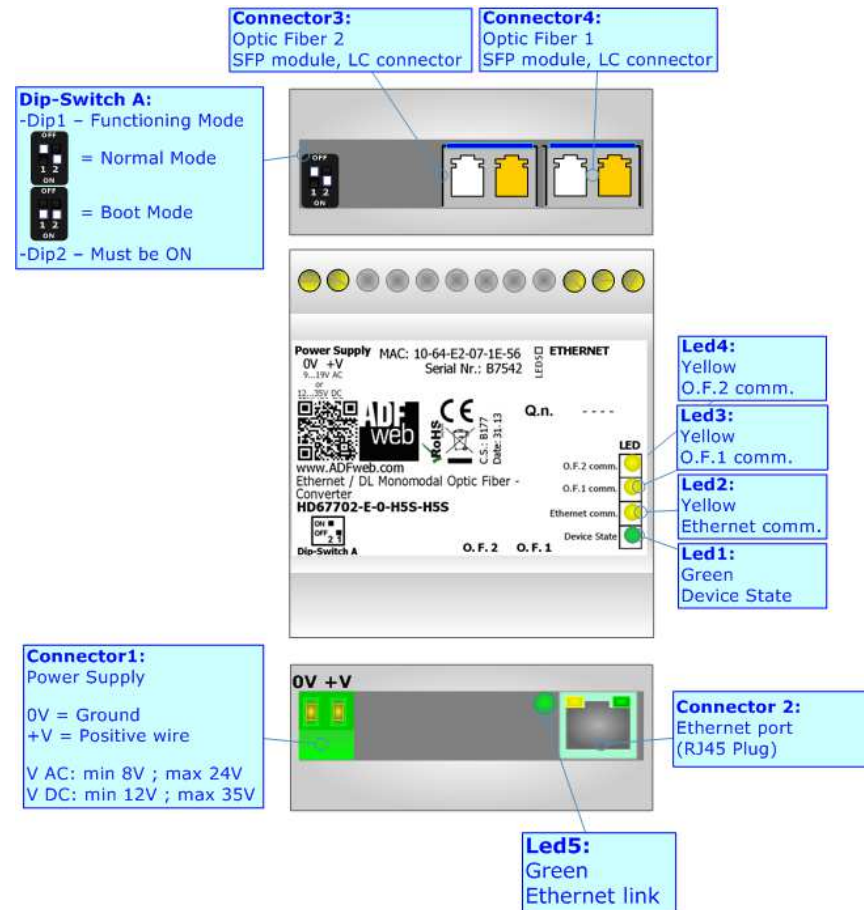

Figure 1h: Connection Scheme for HD67702-E-0-xxx-xxx

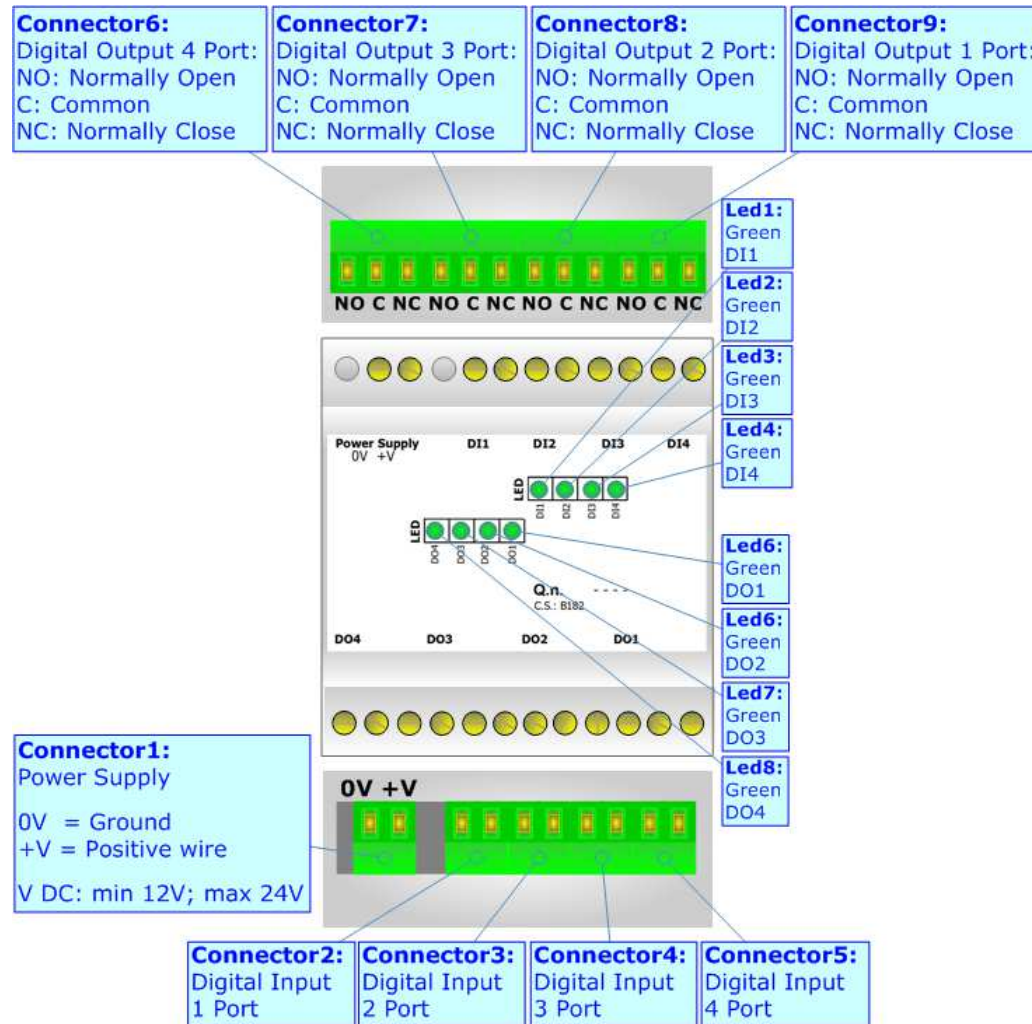

Figure 1i: Connection Scheme for I/O module

CHARACTERISTICS

The HD67701 and HD67702 are a Copper / Optical Fiber Converters.

It has the following characteristics:

- Triple isolation between Bus (copper) - Power Supply, Bus (copper) – Optical Fiber, Power Supply – Optical Fiber.;
- Mountable on 35mm Rail DIN;
- Two-directional information between Bus (copper) and Optical Fiber;
- Wide power supply input range: 8...24V AC or 12...35V DC;
- Wide temperature range: -40°C / 85°C [-40°F / +185°F].

CONFIGURATION:

You need Compositor SW67701 software on your PC in order to perform the following:

- Define the parameters of RS232/RS485/CAN/Ethernet line;
- Define the I/O map (if I/O module is present);
- Update the device.

POWER SUPPLY:

The devices can be powered at 8...19V AC and 12...35V DC. For more details see the two tables below.

VAC		VDC	
Vmin	Vmax	Vmin	Vmax
8V	24V	12V	35V

Consumption at 24V DC:

Device	Consumption [W/VA]
HD67701-2/4/C/E-0-xxx	3.5
HD67702-2/4/C/E-0-xxx-xxx	3.5

Caution: Not reverse the polarity power

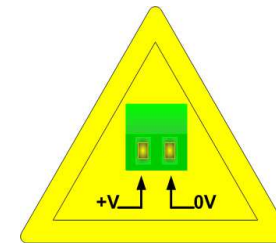
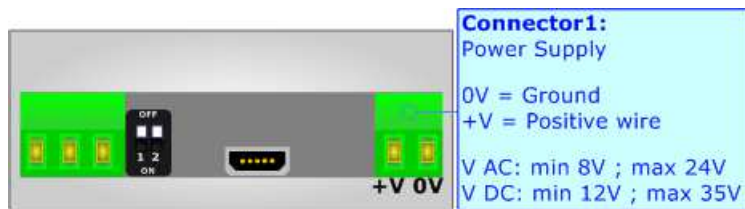

HD67701
HD67702

FUNCTION MODES:

The device has got two functions mode depending of the position of the 'Dip1 of Dip-Switch A':

- The first, with 'Dip1 of Dip-Switch A' at "OFF" position, is used for the normal working of the device.
- The second, with 'Dip1 of Dip-Switch A' at "ON" position, is used for upload the Project and/or Firmware.

For the operations to follow for the updating, see 'UPDATE DEVICE' section.

According to the functioning mode, the LEDs will have specifics functions, see 'LEDS' section.

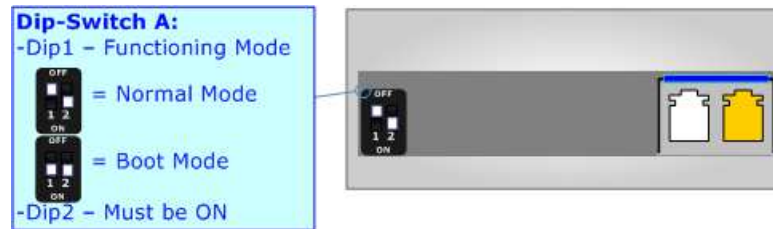
**Warning:**

Dip2 of 'Dip-Switch A' must be at ON position for working even if the Ethernet cable isn't inserted.

LEDS:

The device has got five LEDs that are used to give information of the functioning status. The various meanings of the LEDs are described in the table below.

LED	Normal Mode	Boot Mode
1: Device State (green)	Blinks slowly (~1Hz)	Blinks quickly: Boot state Blinks very slowly (~0.5Hz): update in progress
2: Bus comm. (yellow)	Blinks quickly for a short time when a frame is received (Serial, CAN or Ethernet)	Blinks quickly: Boot state Blinks very slowly (~0.5Hz): update in progress
3: O.F.1 comm. (yellow)	Blinks quickly for a short time when data on Optical Fiber 1 is received	Blinks quickly: Boot state Blinks very slowly (~0.5Hz): update in progress
4: O.F.2 comm. (yellow)	Blinks quickly for a short time when data on Optical Fiber 2 is received	Blinks quickly: Boot state Blinks very slowly (~0.5Hz): update in progress
5: Ethernet Link (green) (only for HD67701-E and HD67702-E)	ON: Ethernet cable inserted OFF: Ethernet cable not inserted	Blinks quickly: Boot state Blinks very slowly (~0.5Hz): update in progress

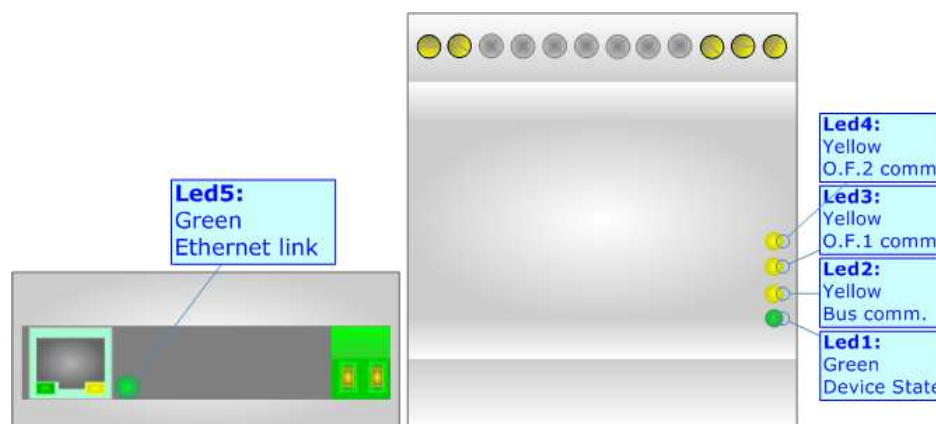

RS232 (for HD67701-2-0-xxx and HD67702-2-0-xxx-xxx):

The connection from RS232 socket to a serial port must be made with a cable with these characteristics:

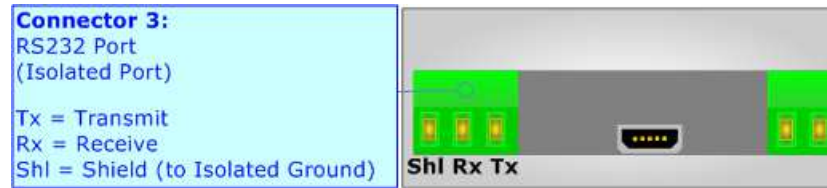

It is recommended that the cable not exceed 15 meters.

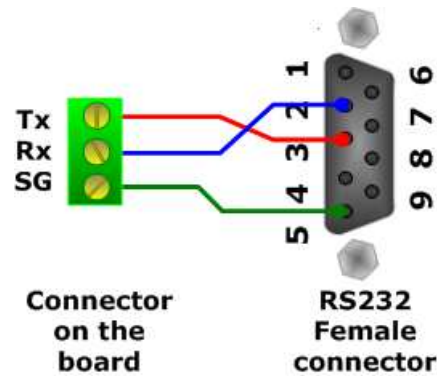

RS485 (for HD67701-4-0-xxx and HD67702-4-0-xxx-xxx):

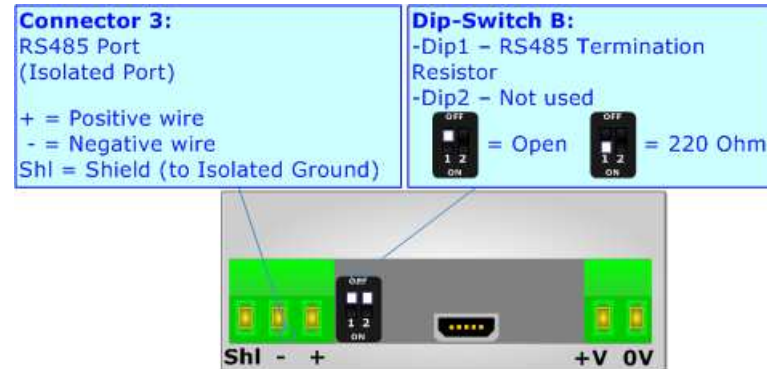

For terminate the RS485 line with a 220Ω resistor it is necessary that the 'Dip1' of the Dip-Switch B is at ON position.

The maximum length of the cable should be 1200m (4000 feet).

Here some codes of cables:

- Belden: p/n 8132 - 2x 28AWG stranded twisted pairs conductor + foil shield + braid shield;
- Belden p/n 82842 - 2x 24AWG stranded twisted pairs conductor + foil shield + braid shield;
- Tasker: p/n C521 - 1x 24AWG twisted pair conductor + foil shield + braid shield;
- Tasker: p/n C522 - 2x 24AWG twisted pairs conductor + foil shield + braid shield.

CAN (for HD67701-C-0-xxx and HD67702-C-0-xxx-xxx):

To terminate the CAN line with a 120Ω resistor it is necessary that the 'Dip1' of the Dip-Switch B is at ON position. CAN interface is compliant with ISO 11898 standard.

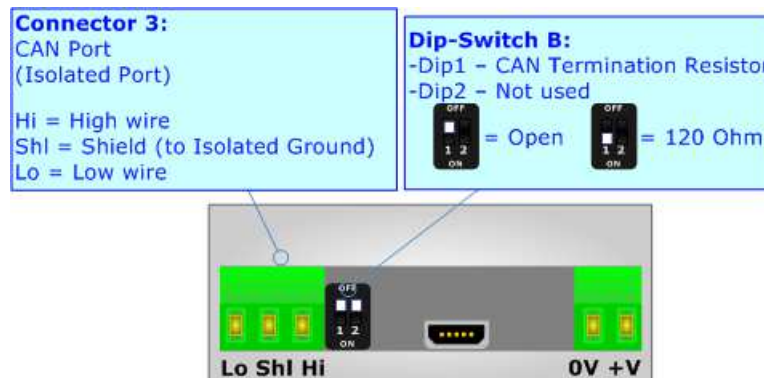

Cable characteristics:

DC parameter:	Impedance	70 Ohm/m
AC parameters:	Impedance	120 Ohm/m
	Delay	5 ns/m
Length	Baud Rate [bps]	Length MAX [m]
	10 K	5000
	20 K	2500
	50 K	1000
	100 K	650
	125 K	500
	250 K	250
	500 K	100
	800 K	50
	1000 K	25

ETHERNET (for HD67701-E-0-xxx and HD67702-E-0-xxx-xxx):

The Ethernet connection must be made using Connector2 of HD67701-E-0-xxx and HD67702-E-0-xxx-xxx with at least a Category 7E cable. The maximum length of the cable should not exceed 100m. The cable has to conform to the T568 norms relative to connections in cat.7 up to 100 Mbps. To connect the device to an Hub/Switch is recommended the use of a straight cable, to connect the device to a PC/PLC/other is recommended the use of a cross cable.

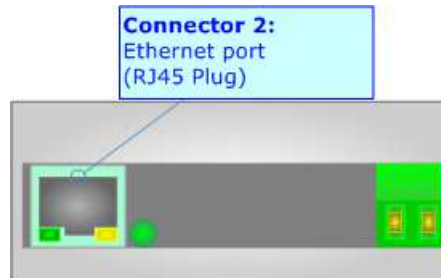

USB (updating port)

The USB connector (Connector2) is a Type-MINI AB Female. So the cable must be a Type-MINI AB Male.

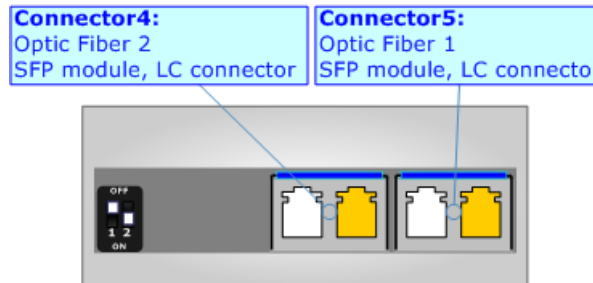

OPTICAL FIBER:

On optical fiber side, the SFPs (Small Factor Pluggable) are mounted: They are interchangeable modules through which you can choose the type of optical fiber and the maximum distance that can be covered.

In relation to the order code, it is possible to have different SFPs module mounted:

- Single-Mode Optical Fiber, LC connectors, Maximum distance of 10 km
- Multi-Mode Optical Fiber, LC connectors, Maximum distance 275 m (with 62.5/125 μm fiber) or 550 m (with 50/125 μm fiber)
- None

I/O MODULE:

In relation to the order code, it is possible to have an I/O module to transmit over Optical Fiber DI and DO and pilot over long distance I/O devices.

Digital Inputs:

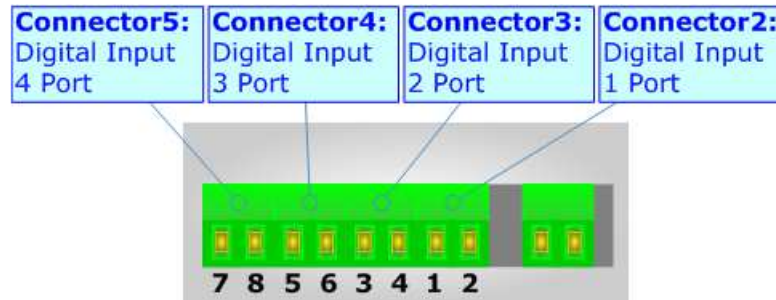

There are two different ways to pilot the DI inside the I/O module:

- Common Power Supply;
- Different Voltage for each DI.

Common Power Supply:

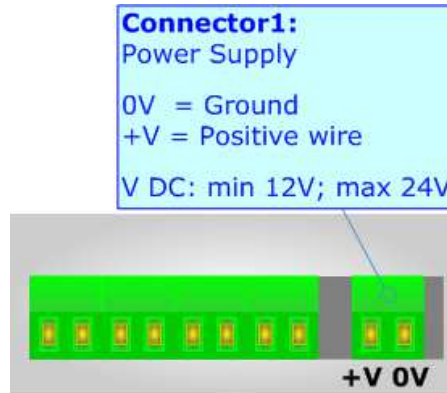

It is possible to feed the I/O Module with a single Power Supply. In this way, to pilot the DI, it enough to short the pins of the DI's connectors.

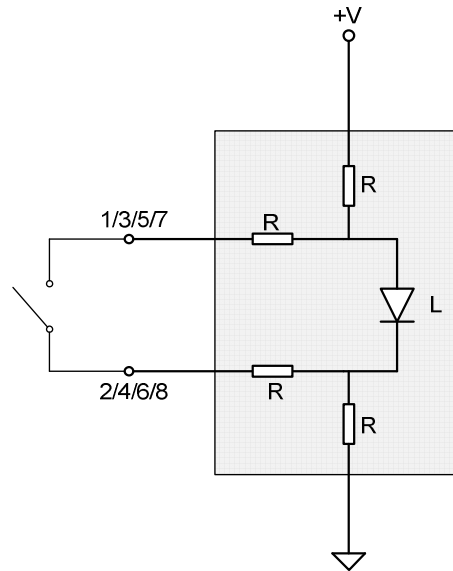

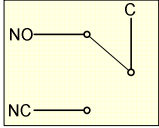
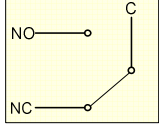
STATUS OF INPUT	STATUS OF OUTPUT	STATUS OF OUTPUT CONTACT
Open	Not activated	NO - C 
Closed (short circuit)	Activated	NC - C 

 Warning: Maximum voltage applied on Power Supply: 24V DC

 Warning: Minimum voltage applied on Power Supply: 12V DC

Different Power Supply for each DI:

It is possible to pilot the DI of the module using a specific voltage for each DI. In order to change the status of the DI, it is enough to apply or not the +V on the pins 1/3/5/7 and fix pins 2/4/6/8 to 0V.

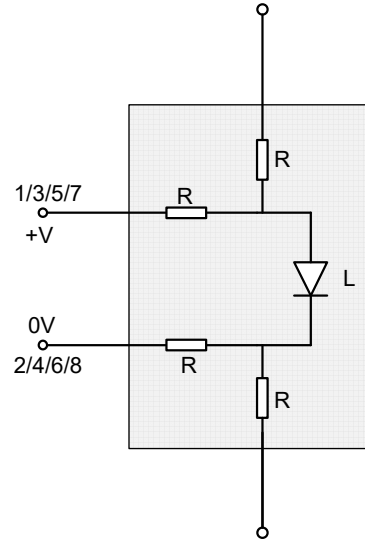

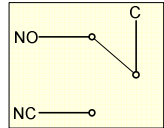
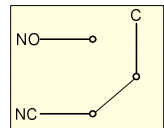
STATUS INPUT	STATUS OF OUTPUT	STATUS OF OUTPUT CONTACT
Opened (V+ not applied)	Not activated	NO - C 
Closed (V+ applied)	Activated	NC - C 

 **Warning:** Maximum voltage applied +V: 24V DC

 **Warning:** Minimum voltage applied +V: 6V DC

Digital Outputs:

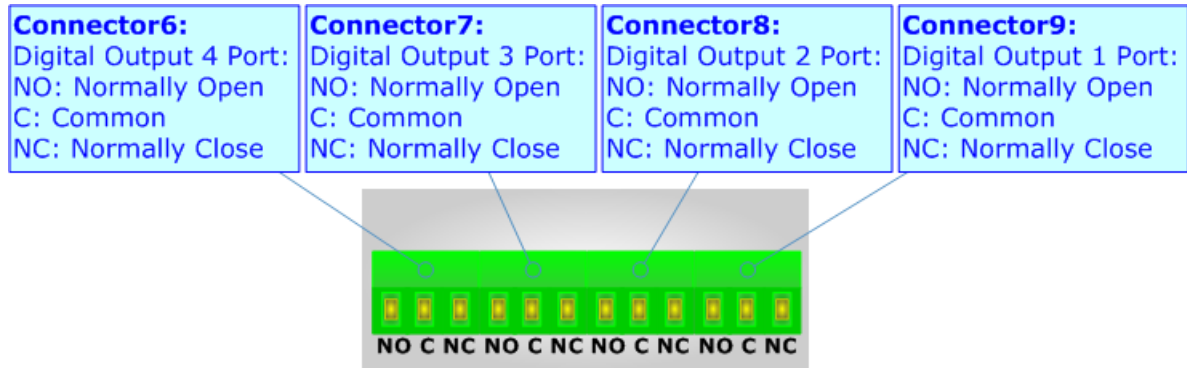

The Digital Outputs of the I/O module have two different states in relation to the pin where you will connect:

- NO: Normally Open -> When the Output is not activated, the contact is in this position, so the it is closed between C and NO;
- NC: Normally Close -> When the Output is activated, the contact is in this position, so it is closed between C and NC.



Note:
 The DOs are clean contacts, any voltage is supplied.

Leds:

The I/O module has got eight LEDs that are used to give information of the DI and DO status. The various meanings of the LEDs are described in the table below.

LED	MEANING
1: DI1 (green)	ON: Opened OFF: Closed
2: DI2. (green)	ON: Opened OFF: Closed
3: DI3 (green)	ON: Opened OFF: Closed
4: DI4 (green)	ON: Opened OFF: Closed
5: DO1 (green)	ON: Activated (NC-C) OFF: Not Activated (NO-C)
6: DO2. (green)	ON: Activated (NC-C) OFF: Not Activated (NO-C)
7: DO3 (green)	ON: Activated (NC-C) OFF: Not Activated (NO-C)
8: DO4 (green)	ON: Activated (NC-C) OFF: Not Activated (NO-C)

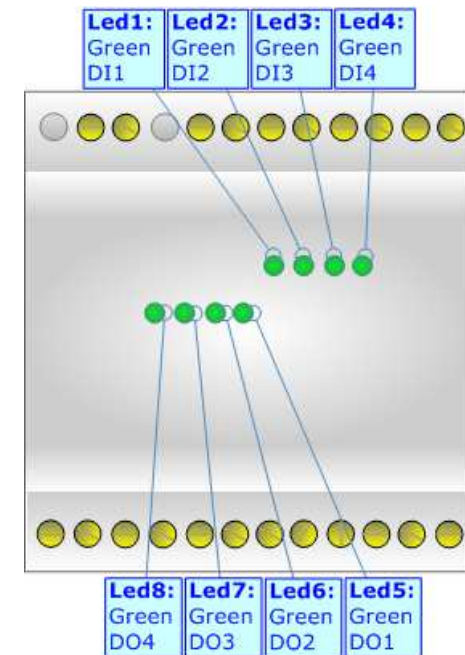

USE OF COMPOSITOR SW67701:

To configure the Converter, use the available software that runs with Windows called SW67701. It is downloadable on the site www.adfweb.com and its operation is described in this document. (*This manual is referenced to the last version of the software present on our web site*). The software works with MSWindows (XP, Vista, Seven, 8; 32/64bit).

When launching the SW67701, the window below appears (Fig. 2).

 **Note:**
It is necessary to have installed .Net Framework 4.

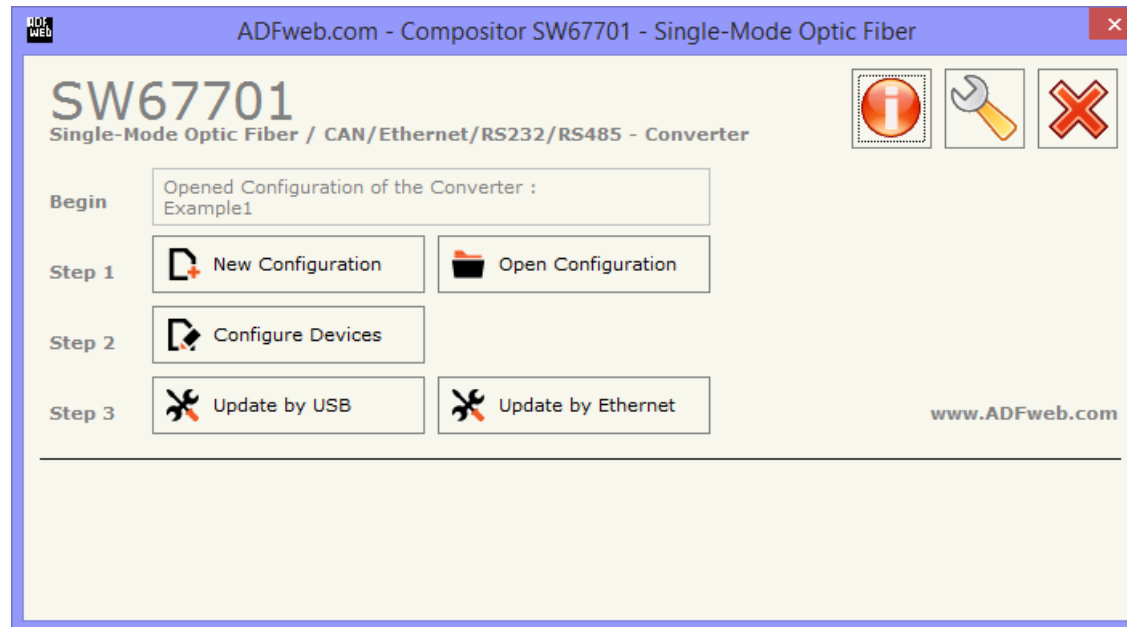
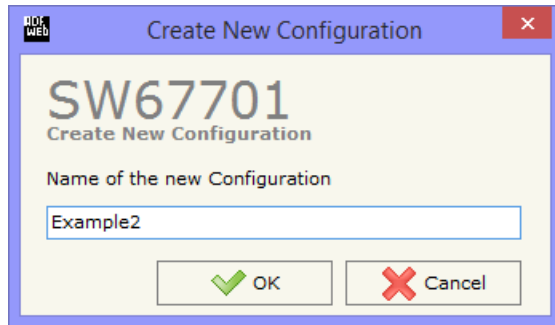

Figure 2: Main window for SW67701

NEW CONFIGURATION / OPEN CONFIGURATION:

The “**New Configuration**” button creates the folder which contains the entire device’s configuration.



A device’s configuration can also be imported or exported:

- To clone the configurations of a Programmable “Copper / Optical Fiber - Converter” in order to configure another device in the same manner, it is necessary to maintain the folder and all its contents;
- To clone a project in order to obtain a different version of the project, it is sufficient to duplicate the project folder with another name and open the new folder with the button “**Open Configuration**”.

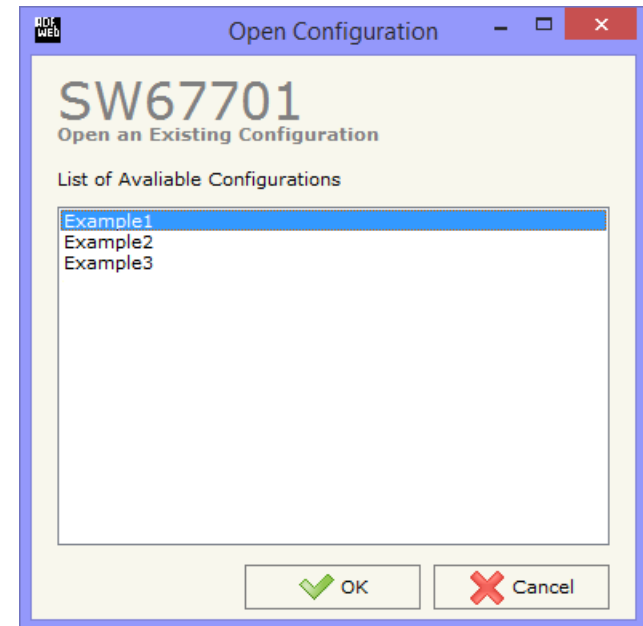

SOFTWARE OPTIONS:

By pressing the “**Settings**” () button there is the possibility to change the language of the software and check the updatings for the compositor.

In the section “Language” it is possible to change the language of the software.

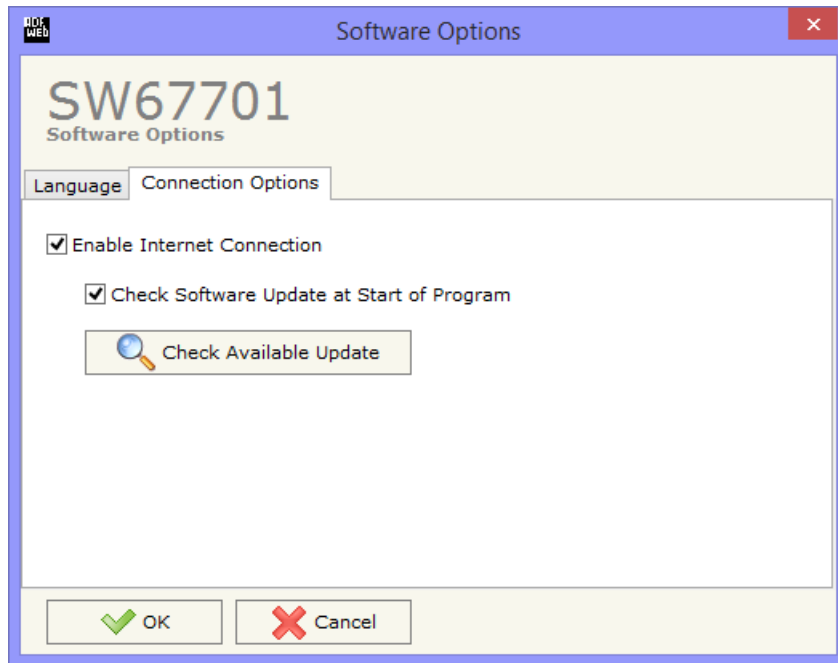

In the section “Connection Options”, it is possible to check if there are some updatings of the software compositor in ADFweb.com website. Checking the option “**Check Software Update at Start of Program**”, the SW67701 check automatically if there are updatings when it is launched.

CONFIGURE DEVICES:

By pressing the “**Configure Devices**” button from the main window for SW67701 (Fig. 2), the window “Configure Devices” appears (Fig. 3).

It is possible to add a new device by pressing the “**Add**” button and remove an existing device by pressing the “**Remove**” button.

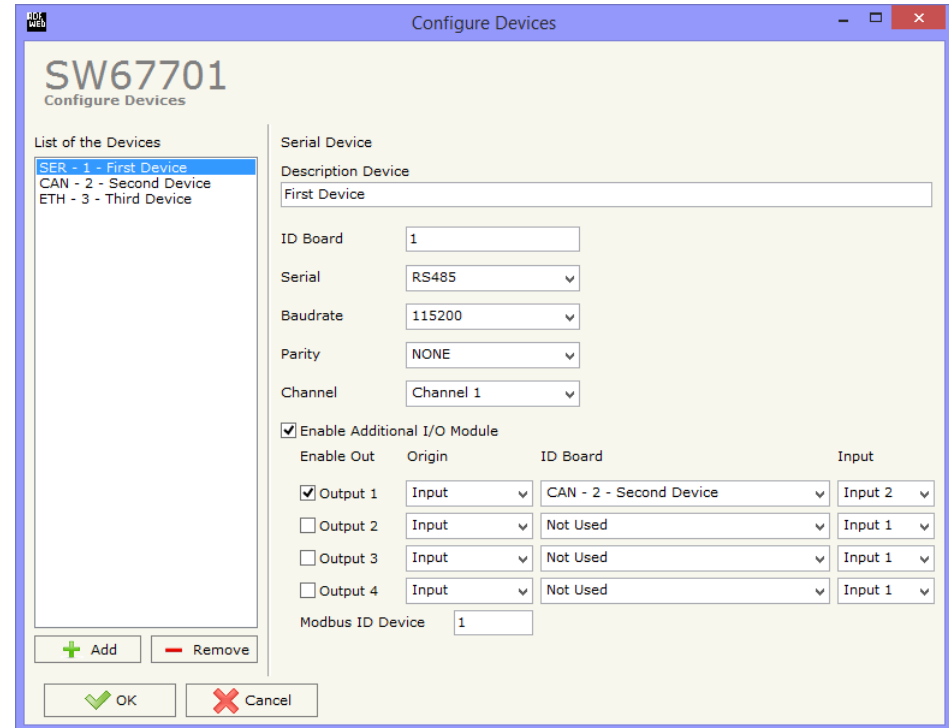

Figure 3: “Configure devices” window

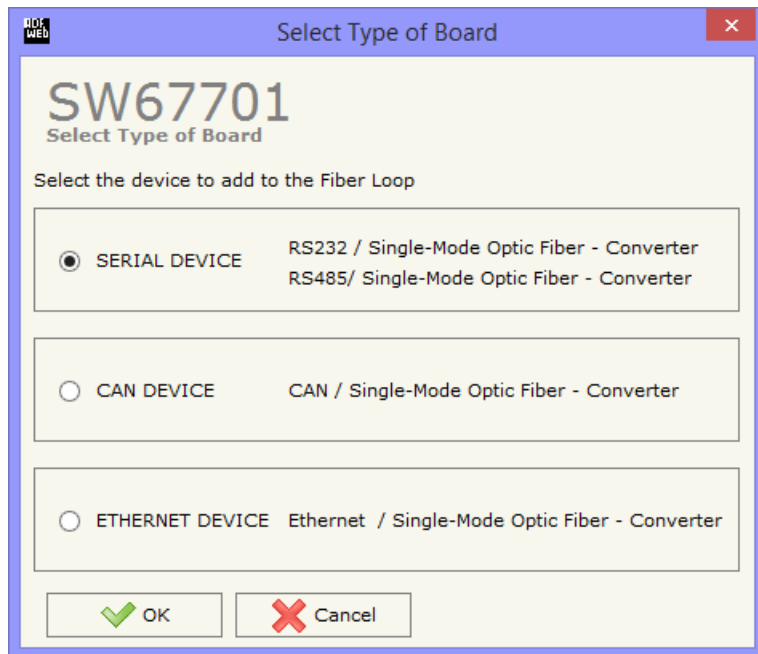

Figure 4: “Select Type of Board” window

When the “Add” button is pressed, the “**Select Type of Board**” window appears (Fig. 4). In this window, the type of board (Serial Device, CAN Device or Ethernet Device) must be defined.

SERIAL DEVICE:

For the Serial Devices, the fields to compile are the following (Fig. 5):

- In the field **"ID Board"**, the ID of the board is defined;
- In the field **"Serial"**, the type of serial port (RS232 or RS485) is defined;
- In the field **"Baudrate"**, the baudrate of the serial line is defined;
- In the field **"Parity"**, the parity of the serial line is defined;
- In the field **"Channel"**, the communication channel is defined; you can define up to 4 channels (4 different serial networks in the same optical fiber's network).

CAN DEVICE:

For the CAN Devices, the fields to compile are the following (Fig. 6):

- In the field **"ID Board"**, the ID of the board is defined;
- In the field **"Baudrate"**, the baudrate of the CAN line is defined;
- In the field **"Channel"**, the communication channel is defined; you can define up to 4 channels (4 different CAN networks in the same optical fiber's network).

ETHERNET DEVICE:

For the Serial Devices, the fields to compile are the following (Fig. 7):

- In the field **"ID Board"**, the ID of the board is defined;
- In the field **"IP Address"**, the IP Address of the board is defined;
- In the field **"SubNet Mask"**, the SubNet Mask is defined;
- If the field **"Gateway"** is checked, in the field below it is possible to insert the IP Address of the default gateway for going out to the net.

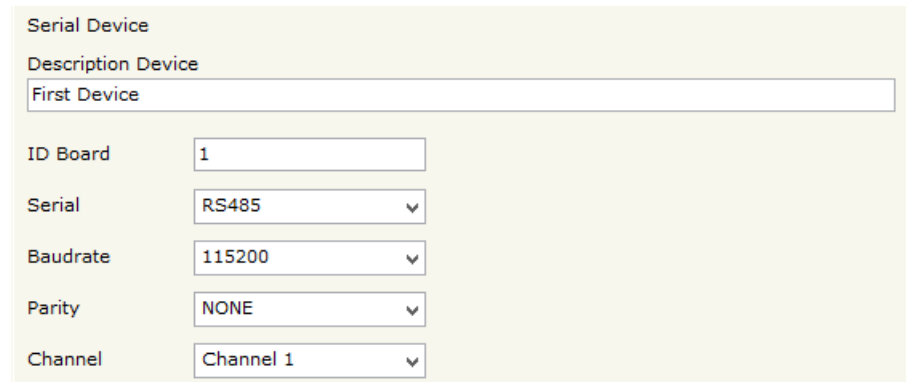

Figure 5: "Serial device" fields

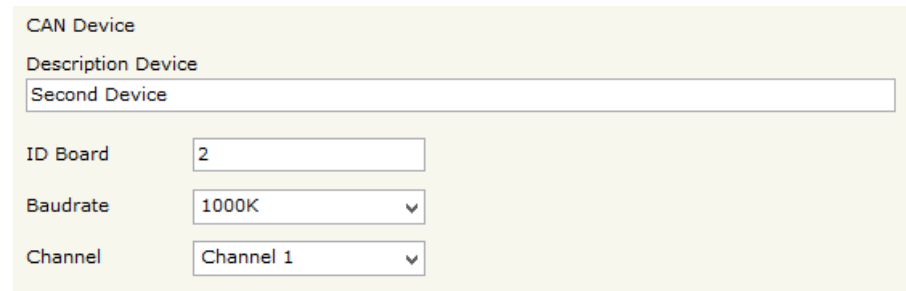

Figure 6: "CAN device" fields

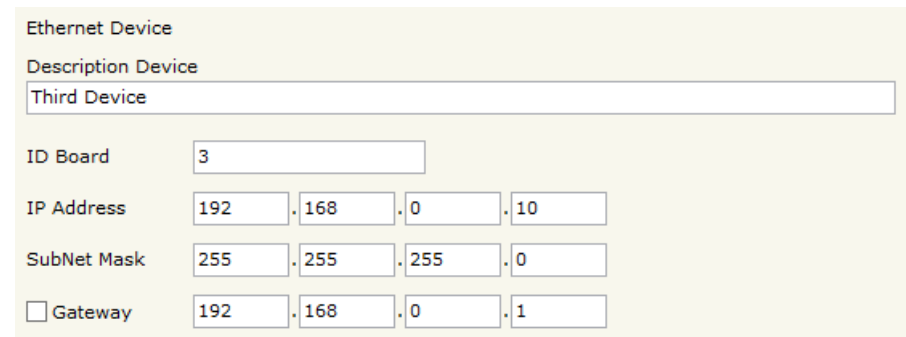

Figure 7: "Ethernet device" fields



Note:

The IDs of the boards in the same network must be different between them.

After having set the general parameters for the bus mounted inside the converter, for all the device types there is the possibility to configure the I/O module (if it is present). The means of the fields are (Fig. 8):

- If the field "**Enable Additional I/O Module**" is checked, the I/O module is enabled (only if it is present);
- If the field "**Enable Out**" is checked, the Output of the I/O module is enabled;
- In the field "**Origin**", the type of command to drive the Output is defined (Digital signal or Modbus command);
- In the field "**ID Board**", the source board from which the Digital command will arrive is defined (only if you set 'Input' as "Origin");
- In the field "**Input**", the Input line of the I/O module of the source board from which the Digital command will arrive is defined (only if you set 'Input' as "Origin");
- In the field "**Modbus ID Device**", the Modbus ID of the board to address the Modbus commands is defined.

<input type="checkbox"/> Enable Additional I/O Module			
Enable Out	Origin	ID Board	Input
<input type="checkbox"/> Output 1	Input	Not Used	Input 1
<input type="checkbox"/> Output 2	Input	Not Used	Input 1
<input type="checkbox"/> Output 3	Input	Not Used	Input 1
<input type="checkbox"/> Output 4	Input	Not Used	Input 1
Modbus ID Device		1	

Figure 8: "I/O settings" fields

MODBUS REGISTERS TABLE:

The Modbus commands can be sent over Serial (RS232/RS485) or over Ethernet: in the first case, it is necessary to use Modbus RTU format, in the second Modbus TCP.

In order to read the communication diagnostic and set the Outputs over Modbus commands, it is necessary to follow this table:

Modbus Register/Flag	Type	R/W	Meaning
16	Coil/Input Status	R/W	Read/Write Status Output 1
17	Coil/Input Status	R/W	Read/Write Status Output 2
18	Coil/Input Status	R/W	Read/Write Status Output 3
19	Coil/Input Status	R/W	Read/Write Status Output 4
24	Coil/Input Status	R	Read Status Input 1
25	Coil/Input Status	R	Read Status Input 1
26	Coil/Input Status	R	Read Status Input 1
27	Coil/Input Status	R	Read Status Input 1
0	Holding/Input Register	R	ID of the board
1	Holding/Input Register	R	Read Status Inputs / Outputs
2	Holding/Input Register	R	Hi Byte: Type of board (*) - Low Byte: 0
3	Holding/Input Register	R	Communication Channel's Number (**)
5	Holding/Input Register	R	Low Byte: nodes of loop 0 - Hi Byte: node of loop 1
6	Holding/Input Register	R	Previous node on Loop 0 (Low Byte)
7	Holding/Input Register	R	Previous node on Loop 1 (Low Byte)
16	Holding/Input Register	R/W (***)	Number of errors
17	Holding/Input Register	R/W (***)	Number of packets on received Optical Fiber
18	Holding/Input Register	R/W (***)	Number of bytes on received Optical Fiber
19	Holding/Input Register	R/W (***)	Test Time (minutes)
20-21	Holding/Input Register	R/W (***)	IP Address of the board (if it has Ethernet port)
22	Holding/Input Register	R/W (***)	Number of bytes on received copper side

(*) Type of Board:

Type of Board							
bit7	bit6	bit5	bit4	bit3	bit2	bit1	bit0
0	0	0	x	x	x	x	x

Bit3-Bit0:

- 0000B: RS485
- 0001B: RS232
- 0010B: CAN
- 0011B: Ethernet

Bit4:

- 0: I/O Module Not Present/Enabled
- 1: I/O Module Present/Enabled

(**) Communication Channel's Number:

- 0x00: Serial Channel 1
- 0x01: Serial Channel 2
- 0x02: Serial Channel 3
- 0x03: Serial Channel 4
- 0x10: CAN Channel 1
- 0x11: CAN Channel 2
- 0x12: CAN Channel 3
- 0x13: CAN Channel 4
- 0x20: Ethernet Channel

(***) You can write these registers to '0' to reset the tests and restart to analyze the communication status.



Note:

The diagnostic registers can be monitored easily with the "FO_Test" software. It is possible to download the manual from here: www.adfweb.com/download/filefold/MNFOTEST_ENG.pdf

UPDATE BY USB (for Serial and CAN versions):

By pressing the **“Update Device”** button it is possible to load the created Configuration into the device and also the Firmware, if is necessary.

In order to load the parameters or update the firmware in the device, follow these instructions:

- Turn off the Device;
- Connect the USB cable form your PC to the converter;
- Put Dip1 of Dip-Switch A at **“ON”** position;
- Select the **“COM port”** and press the **“Connect”** button;
- Select the Configuration/Device that you want to update;
- Turn on the device;
- Press the **“Next”** button;
- Select which operations you want to do.
- Press the **“Execute update firmware”** button to start the upload;
- When all the operations are **“OK”**, turn off the device;
- Put Dip1 of Dip-Switch A at **“OFF”** position;
- Disconnect the USB Cable;
- Turn on the device.

At this point the configuration/firmware on the device is correctly update.

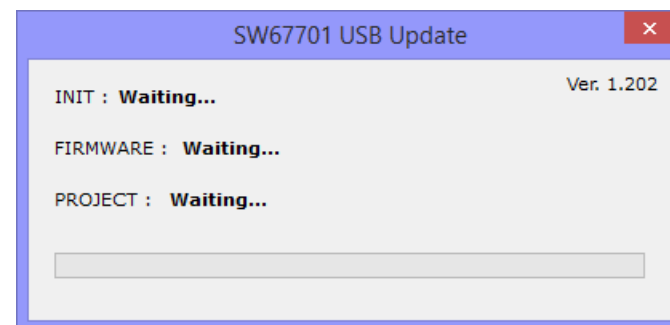
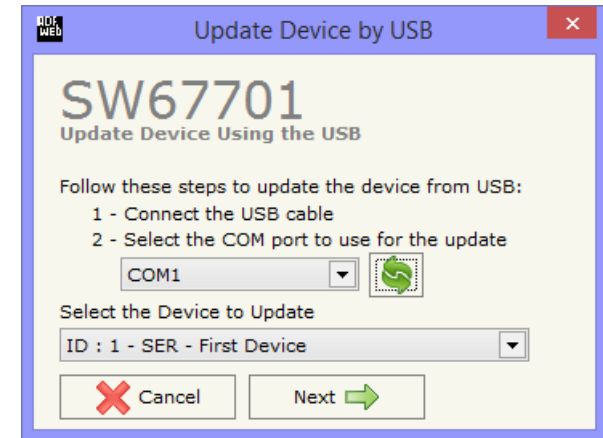

Figure 9: “Update by USB” windows

UPDATE BY ETHERNET (only for Ethernet version):

By pressing the **“Update Device”** button, it is possible to load the created Configuration into the device; and also the Firmware, if necessary.

If you don't know the actual IP address of the device you have to use this procedure:

- Turn off the Device;
- Put Dip1 of 'Dip-Switch A' in ON position;
- Turn on the device
- Connect the Ethernet cable;
- Insert the IP **“192.168.2.205”**;
- Press the **“Ping”** button, **“Device Found!”** must appear;
- Press the **“Next”** button;
- Select which operations you want to do;
- Press the **“Execute update firmware”** button to start the upload;
- When all the operations are **“OK”** turn off the Device;
- Put Dip1 of 'Dip-Switch A' at OFF position;
- Turn on the device.

At this point the configuration/firmware on the device is correctly updated.

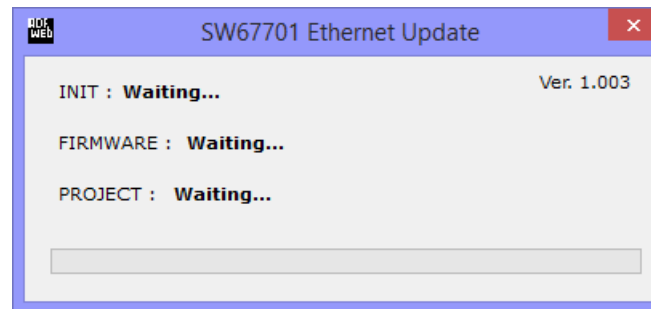
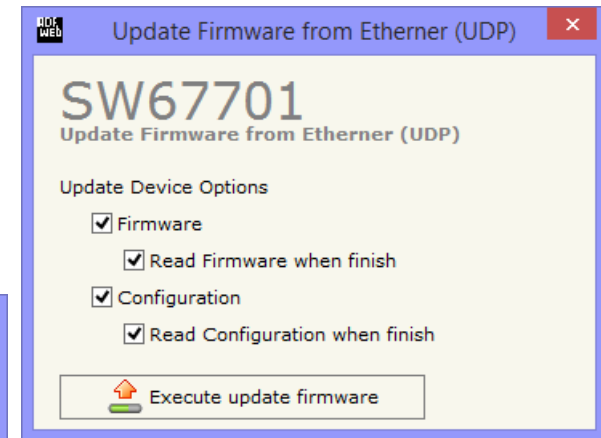
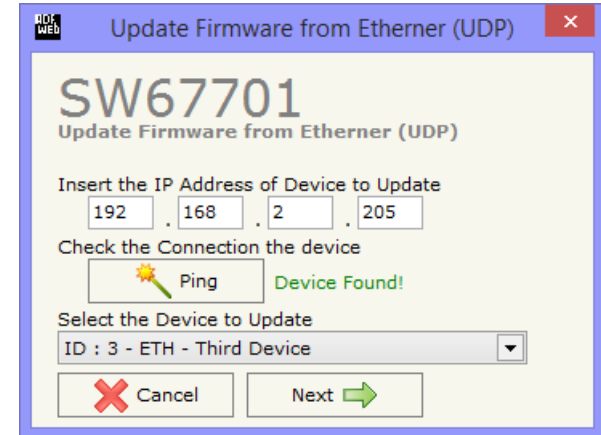

Figure 10: "Update by Ethernet" windows



Note:

When you install a new version of the software, if it is the first time it is better you do the update of the Firmware in the HD67701 and HD67702 device.



Note:

When you receive the device, for the first time, you also have to update the Firmware in the HD67701 and HD67702 device.



Warning:

If Fig. 11 appears when you try to do the Update try these points before seeking assistance:

- Check if the serial COM port selected is the correct one;
- Check if the serial cable is connected between the PC and the device;
- Try to repeat the operations for the updating;
- Try to repeat the operations for the updating;
- Try with another PC;
- Try to restart the PC;
- Check the LAN settings;
- If you are using the program inside a Virtual Machine, try to use in the main Operating System;
- If you are using Windows Seven, Vista and 8 make sure that you have the administrator privileges;
- In case you have to program more than one device, using the "UDP Update", you have to cancel the ARP table every time you connect a new device on Ethernet. For do this you have to launch the "Command Prompt" and write the command "arp -d". Pay attention that with Windows Vista, Seven, 8 you have to launch the "Command Prompt" with Administrator Rights;
- Pay attention at Firewall lock.

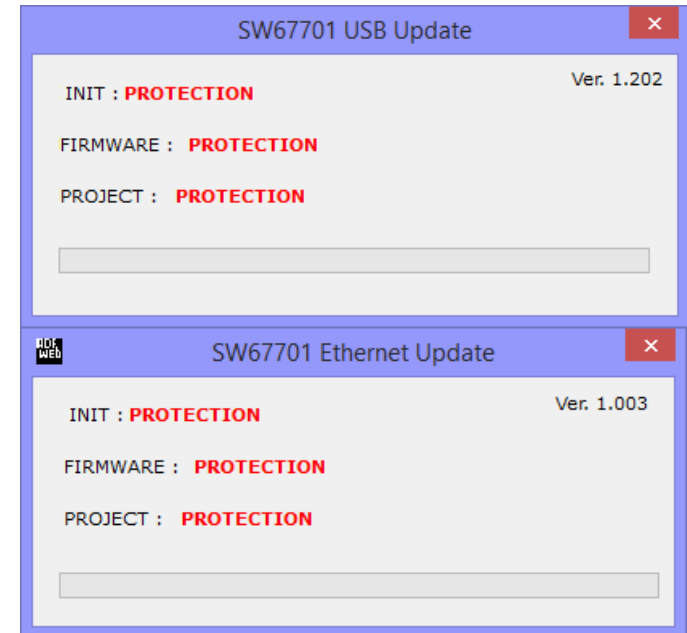
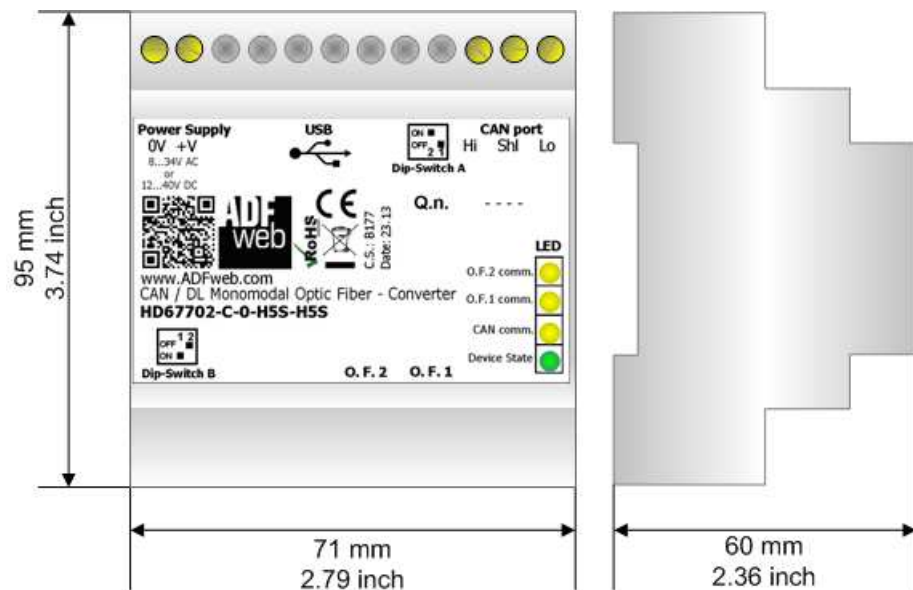

Figure 11: "Protection" windows

In the case of HD67701 or HD67702 you have to use the software "SW67701": www.adfweb.com/download/filefold/SW67701.zip.

MECHANICAL DIMENSIONS:



Housing: PVC
Weight: 200g (Approx)

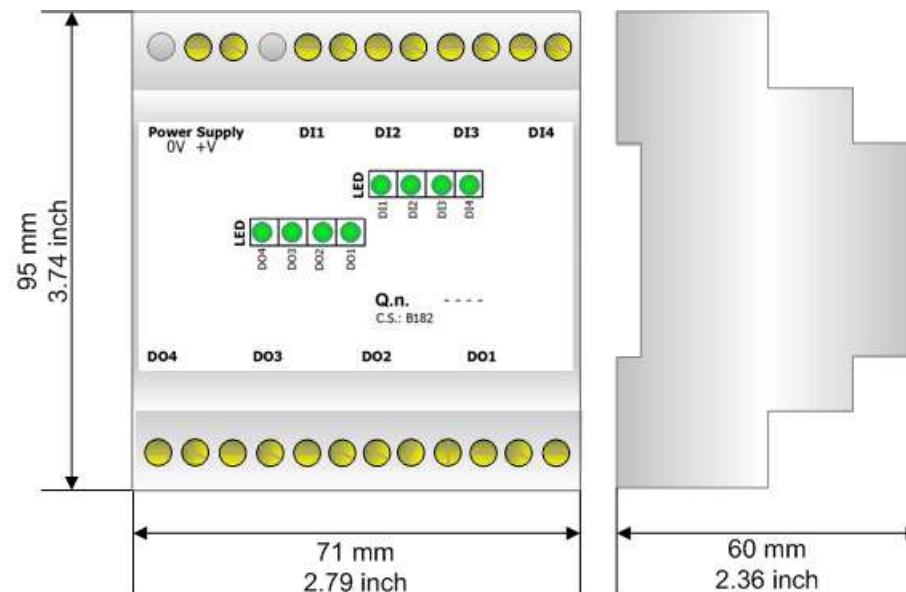

Housing: PVC
Weight: 200g (Approx)

Figure 12a: Mechanical dimensions scheme for HD67701 and HD67702

Figure 12b: Mechanical dimensions scheme for I/O Module



Note:

When the I/O module is present, the converter and the I/O module are put in the same enclosure (8M Modulbox).

ORDER CODES:

HD67701 serie

(Topologies: Single Loop - Point to Point)

HD67701 - x - x - xxx

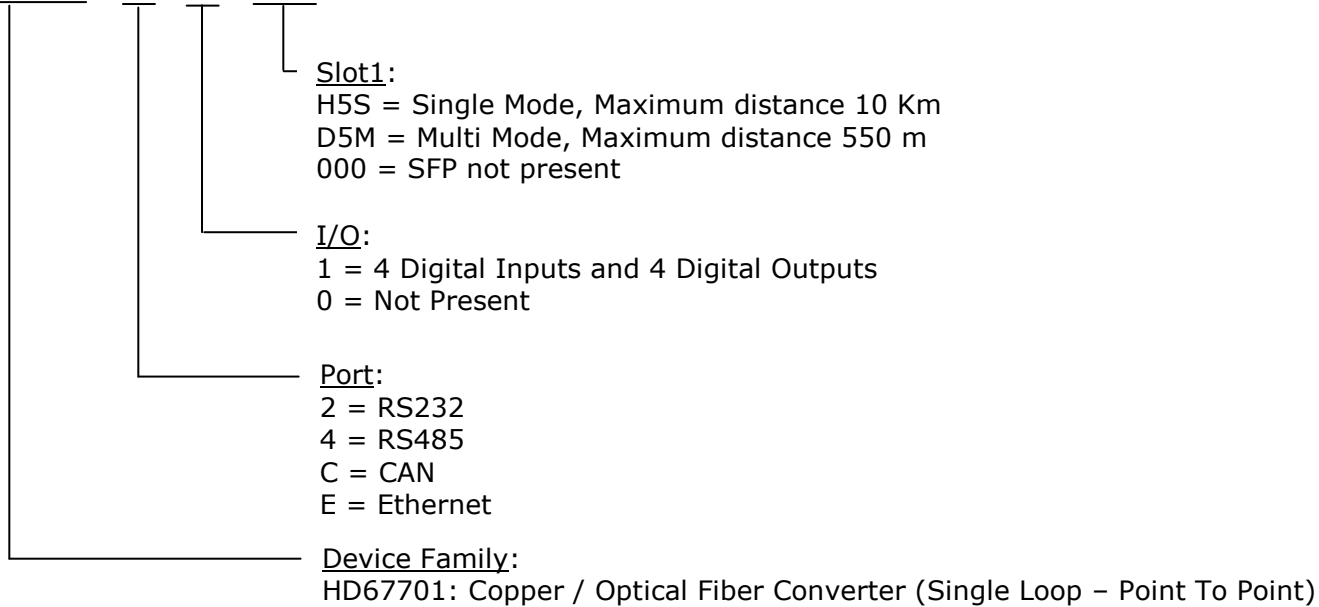

HD67702 serie:

(Topologies: Double Loop – Multidrop)

HD67702 - x - x - xxx - xxx

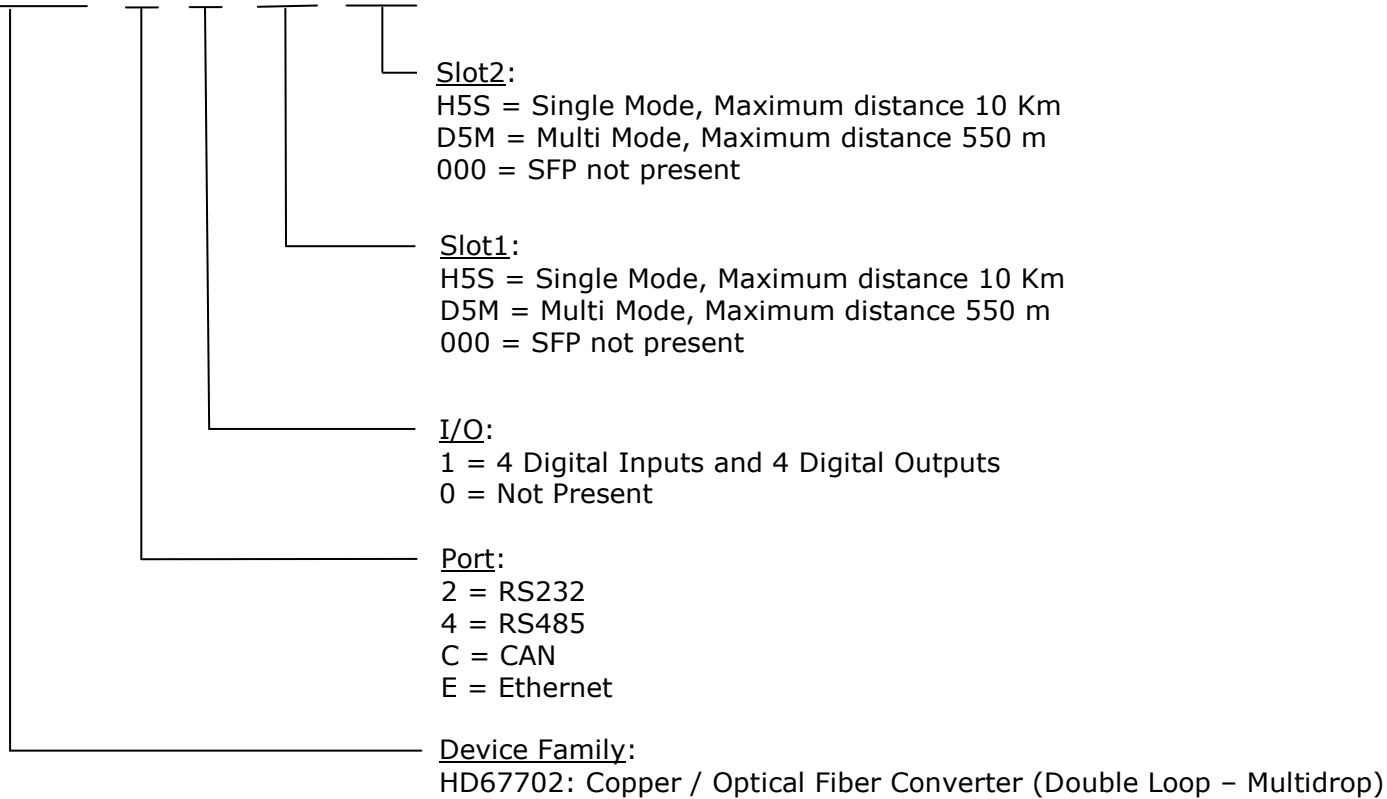

Order Code: HD67701-2-0-H5S	-	RS232 / Single-Mode Optical Fiber Converter (I/O Module not present)
Order Code: HD67701-4-0-H5S	-	RS485 / Single-Mode Optical Fiber Converter (I/O Module not present)
Order Code: HD67701-C-0-H5S	-	CAN / Single-Mode Optical Fiber Converter (I/O Module not present)
Order Code: HD67701-E-0-H5S	-	Ethernet / Single-Mode Optical Fiber Converter (I/O Module not present)
Order Code: HD67701-2-0-D5M	-	RS232 / Multi-Mode Optical Fiber Converter (I/O Module not present)
Order Code: HD67701-4-0-D5M	-	RS485 / Multi-Mode Optical Fiber Converter (I/O Module not present)
Order Code: HD67701-C-0-D5M	-	CAN / Multi-Mode Optical Fiber Converter (I/O Module not present)
Order Code: HD67701-E-0-D5M	-	Ethernet / Multi-Mode Optical Fiber Converter (I/O Module not present)
Order Code: HD67702-2-0-H5S-H5S	-	RS232 / Single-Mode Optical Fiber Converter (I/O Module not present)
Order Code: HD67702-4-0-H5S-H5S	-	RS485 / Single-Mode Optical Fiber Converter (I/O Module not present)
Order Code: HD67702-C-0-H5S-H5S	-	CAN / Single-Mode Optical Fiber Converter (I/O Module not present)
Order Code: HD67702-E-0-H5S-H5S	-	Ethernet / Single-Mode Optical Fiber Converter (I/O Module not present)
Order Code: HD67702-2-0-D5M-D5M	-	RS232 / Multi-Mode Optical Fiber Converter (I/O Module not present)
Order Code: HD67702-4-0-D5M-D5M	-	RS485 / Multi-Mode Optical Fiber Converter (I/O Module not present)
Order Code: HD67702-C-0-D5M-D5M	-	CAN / Multi-Mode Optical Fiber Converter (I/O Module not present)
Order Code: HD67702-E-0-D5M-D5M	-	Ethernet / Multi-Mode Optical Fiber Converter (I/O Module not present)
Order Code: HD67701-2-1-H5S	-	RS232 / Single-Mode Optical Fiber Converter (I/O Module present)
Order Code: HD67701-4-1-H5S	-	RS485 / Single-Mode Optical Fiber Converter (I/O Module present)
Order Code: HD67701-C-1-H5S	-	CAN / Single-Mode Optical Fiber Converter (I/O Module present)
Order Code: HD67701-E-1-H5S	-	Ethernet / Single-Mode Optical Fiber Converter (I/O Module present)
Order Code: HD67701-2-1-D5M	-	RS232 / Multi-Mode Optical Fiber Converter (I/O Module present)
Order Code: HD67701-4-1-D5M	-	RS485 / Multi-Mode Optical Fiber Converter (I/O Module present)
Order Code: HD67701-C-1-D5M	-	CAN / Multi-Mode Optical Fiber Converter (I/O Module present)
Order Code: HD67701-E-1-D5M	-	Ethernet / Multi-Mode Optical Fiber Converter (I/O Module present)
Order Code: HD67702-2-1-H5S-H5S	-	RS232 / Single-Mode Optical Fiber Converter (I/O Module present)
Order Code: HD67702-4-1-H5S-H5S	-	RS485 / Single-Mode Optical Fiber Converter (I/O Module present)
Order Code: HD67702-C-1-H5S-H5S	-	CAN / Single-Mode Optical Fiber Converter (I/O Module present)
Order Code: HD67702-E-1-H5S-H5S	-	Ethernet / Single-Mode Optical Fiber Converter (I/O Module present)
Order Code: HD67702-2-1-D5M-D5M	-	RS232 / Multi-Mode Optical Fiber Converter (I/O Module present)

Order Code: HD67702-4-1-D5M-D5M	-	RS485 / Multi-Mode Optical Fiber Converter (I/O Module present)
Order Code: HD67702-C-1-D5M-D5M	-	CAN / Multi-Mode Optical Fiber Converter (I/O Module present)
Order Code: HD67702-E-1-D5M-D5M	-	Ethernet / Multi-Mode Optical Fiber Converter (I/O Module present)
Order Code: HD67701-2-0-000	-	RS232 / Optical Fiber Converter (I/O Module not present) (SFPs not present)
Order Code: HD67701-4-0-000	-	RS485 / Optical Fiber Converter (I/O Module not present) (SFPs not present)
Order Code: HD67701-C-0-000	-	CAN / Optical Fiber Converter (I/O Module not present) (SFPs not present)
Order Code: HD67701-E-0-000	-	Ethernet / Optical Fiber Converter (I/O Module not present) (SFP not present)
Order Code: HD67702-2-0-000-000	-	RS232 / Optical Fiber Converter (I/O Module not present) (SFPs not present)
Order Code: HD67702-4-0-000-000	-	RS485 / Optical Fiber Converter (I/O Module not present) (SFPs not present)
Order Code: HD67702-C-0-000-000	-	CAN / Optical Fiber Converter (I/O Module not present) (SFPs not present)
Order Code: HD67702-E-0-000-000	-	Ethernet / Optical Fiber Converter (I/O Module not present) (SFPs not present)
Order Code: HD67701-2-1-000	-	RS232 / Optical Fiber Converter (I/O Module present) (SFPs not present)
Order Code: HD67701-4-1-000	-	RS485 / Optical Fiber Converter (I/O Module present) (SFPs not present)
Order Code: HD67701-C-1-000	-	CAN / Optical Fiber Converter (I/O Module present) (SFPs not present)
Order Code: HD67701-E-1-000	-	Ethernet / Optical Fiber Converter (I/O Module present) (SFPs not present)
Order Code: HD67702-2-1-000-000	-	RS232 / Optical Fiber Converter (I/O Module present) (SFPs not present)
Order Code: HD67702-4-1-000-000	-	RS485 / Optical Fiber Converter (I/O Module present) (SFPs not present)
Order Code: HD67702-C-1-000-000	-	CAN / Optical Fiber Converter (I/O Module present) (SFPs not present)
Order Code: HD67702-E-1-000-000	-	Ethernet / Optical Fiber Converter (I/O Module present) (SFPs not present)

ACCESSORIES:

Order Code: AC34001	-	Rail DIN - Power Supply 220/240V AC 50/60Hz – 12 V AC
Order Code: AC34002	-	Rail DIN - Power Supply 110V AC 50/60Hz – 12 V AC

DISCLAIMER:

All technical content within this document can be modified without notice. The content of the document is a under continual renewal. For losses due to fire, earthquake, third party access or other accidents, or intentional or accidental abuse, misuse, or use under abnormal conditions repairs are charged to the user. ADFweb.com S.r.l. will not be liable for accidental loss of use or inability to use this product, such as loss of business income. ADFweb.com S.r.l. shall not be liable for consequences of improper use.

OTHER REGULATIONS AND STANDARDS:**WEEE INFORMATION**

Disposal of old electrical and electronic equipment (as in the European Union and other European countries with separate collection systems).

This symbol on the product or on its packaging indicates that this product may not be treated as household rubbish. Instead, it should be taken to an applicable collection point for the recycling of electrical and electronic equipment. If the product is disposed correctly, you will help prevent potential negative environmental factors and impact of human health, which could otherwise be caused by inappropriate disposal. The recycling of materials will help to conserve natural resources. For more information about recycling this product, please contact your local city office, your household waste disposal service or the shop where you purchased the product.

RESTRICTION OF HAZARDOUS SUBSTANCES DIRECTIVE

The device respects the 2002/95/EC Directive on the restriction of the use of certain hazardous substances in electrical and electronic equipment (commonly referred to as Restriction of Hazardous Substances Directive or RoHS).

CE MARKING

The product conforms with the essential requirements of the applicable EC directives.

WARRANTIES AND TECHNICAL SUPPORT:

For fast and easy technical support for your ADFweb.com SRL products, consult our internet support at www.adfweb.com. Otherwise contact us at the address support@adfweb.com

RETURN POLICY:

If while using your product you have any problem and you wish to exchange or repair it, please do the following:

- Obtain a Product Return Number (PRN) from our internet support at www.adfweb.com. Together with the request, you need to provide detailed information about the problem.
- Send the product to the address provided with the PRN, having prepaid the shipping costs (shipment costs billed to us will not be accepted).

If the product is within the warranty of twelve months, it will be repaired or exchanged and returned within three weeks. If the product is no longer under warranty, you will receive a repair estimate.



ADFweb.com S.r.l.
Via Strada Nuova, 17
IT-31010 Mareno di Piave
TREVISO (Italy)
Phone +39.0438.30.91.31
Fax +39.0438.49.20.99
www.adfweb.com

