

User Manual

Revision 1.100
English

- ⊕ Very easy to configure
- ⊕ Electrical isolation
- ⊕ Temperature range: -40°C/85°C (-40°F/185°F)

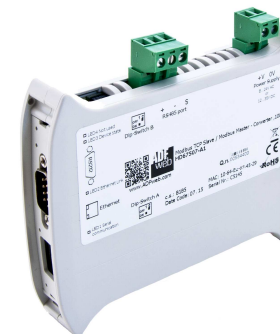

INDEX:

	Page
INDEX	2
UPDATED DOCUMENTATION	2
REVISION LIST	2
WARNING	2
TRADEMARKS	2
SECURITY ALERT	3
EXAMPLE OF CONNECTION	4
CONNECTION SCHEME	5
CHARACTERISTICS	7
CONFIGURATION	7
POWER SUPPLY	8
FUNCTION MODES	9
LEDS	10
SNMP	11
CAN	12
USE OF COMPOSITOR SW67155	13
NEW PROJECT / OPEN PROJECT	14
SOFTWARE OPTIONS	15
SET COMMUNICATION	17
RECEIVE FRAMES	18
INFO RECEIVE	19
SEND FRAMES	20
INFO SEND	21
SET SNMP ACCESS	22
UPDATE DEVICE	24
SNMP COMMUNICATION	26
SENDING ASYNCHRONOUS CAN MESSAGES FROM ETHERNET	31
MECHANICAL DIMENSIONS	33
ORDERING INFORMATIONS	35
ACCESSORIES	35
DISCLAIMER	36
OTHER REGULATIONS AND STANDARDS	36
WARRANTIES AND TECHNICAL SUPPORT	37
RETURN POLICY	37

UPDATED DOCUMENTATION:

Dear customer, we thank you for your attention and we remind you that you need to check that the following document is:

- ✚ Updated
- ✚ Related to the product you own

To obtain the most recently updated document, note the “document code” that appears at the top right-hand corner of each page of this document.

With this “Document Code” go to web page www.adfweb.com/download/ and search for the corresponding code on the page. Click on the proper “Document Code” and download the updates.

REVISION LIST:

Revision	Date	Author	Chapter	Description
1.000	05/01/2015	Ff	All	First Release
1.100	01/02/2017	Ff	All	New software version

WARNING:

ADFweb.com reserves the right to change information in this manual about our product without warning. ADFweb.com is not responsible for any error this manual may contain.

TRADEMARKS:

All trademarks mentioned in this document belong to their respective owners.

SECURITY ALERT:**GENERAL INFORMATION**

To ensure safe operation, the device must be operated according to the instructions in the manual. When using the device, legal and safety regulation are required for each individual application. The same applies also when using accessories.

INTENDED USE

Machines and systems must be designed so the faulty conditions do not lead to a dangerous situation for the operator (i.e. independent limit switches, mechanical interlocks, etc.).

QUALIFIED PERSONNEL

The device can be used only by qualified personnel, strictly in accordance with the specifications. Qualified personnel are persons who are familiar with the installation, assembly, commissioning and operation of this equipment and who have appropriate qualifications for their job.

RESIDUAL RISKS

The device is state-of-the-art and is safe. The instruments can represent a potential hazard if they are inappropriately installed and operated by untrained personnel. These instructions refer to residual risks with the following symbol:



This symbol indicates that non-observance of the safety instructions is a danger for people that could lead to serious injury or death and / or the possibility of damage.

CE CONFORMITY

The declaration is made by our company. You can send an email to or give us a call if you need it.

EXAMPLE OF CONNECTION:

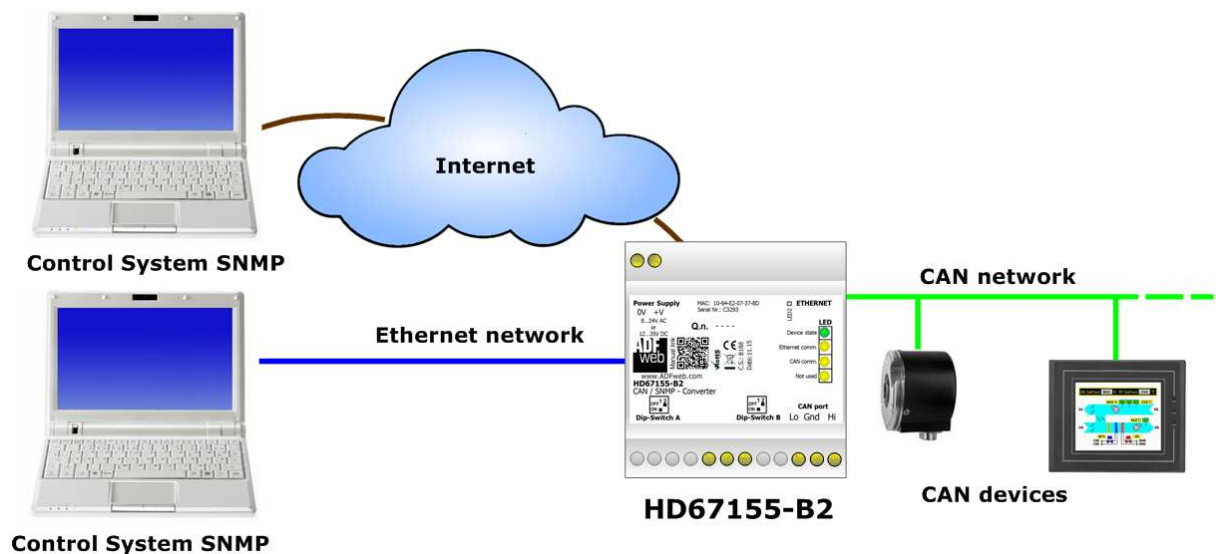
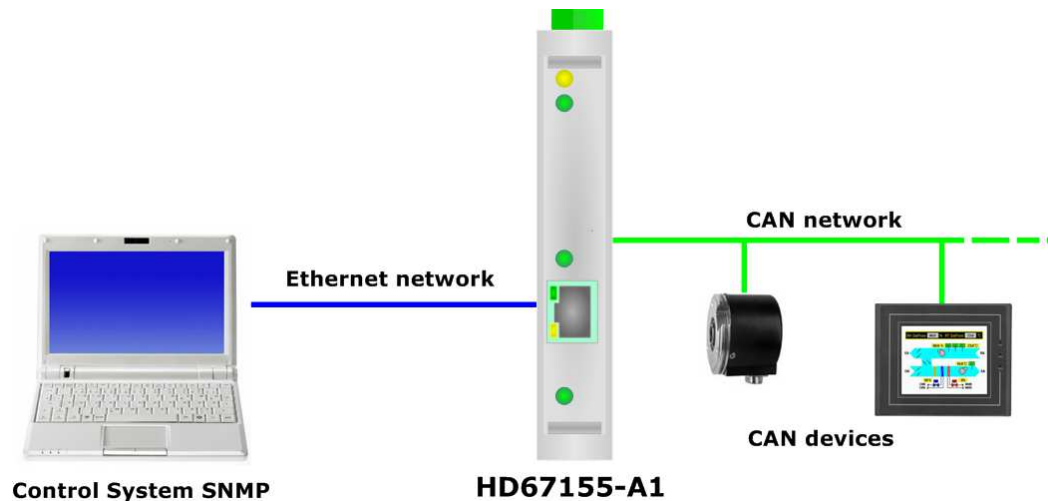

CONNECTION SCHEME:

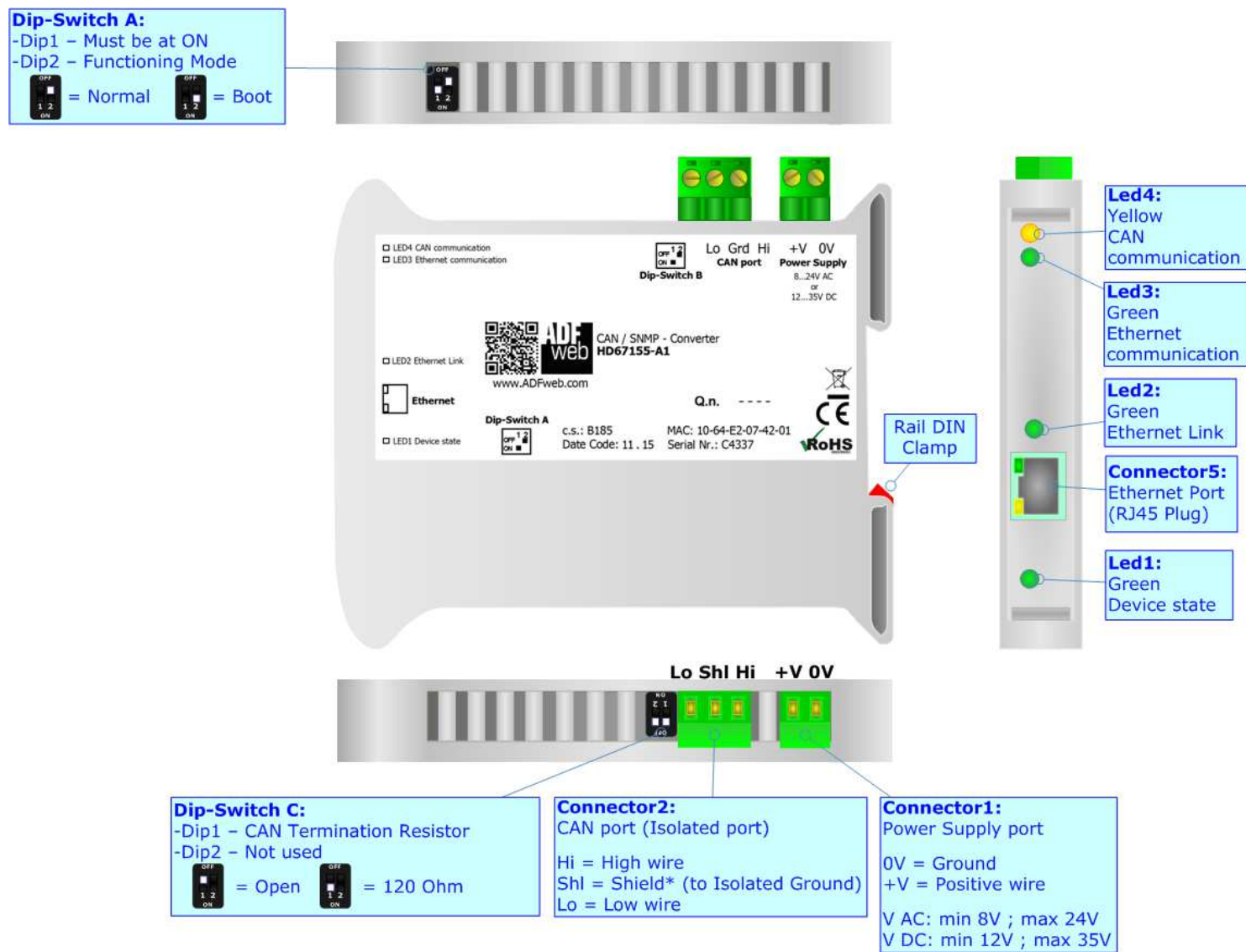

Figure 1a: Connection scheme for HD67155-A1

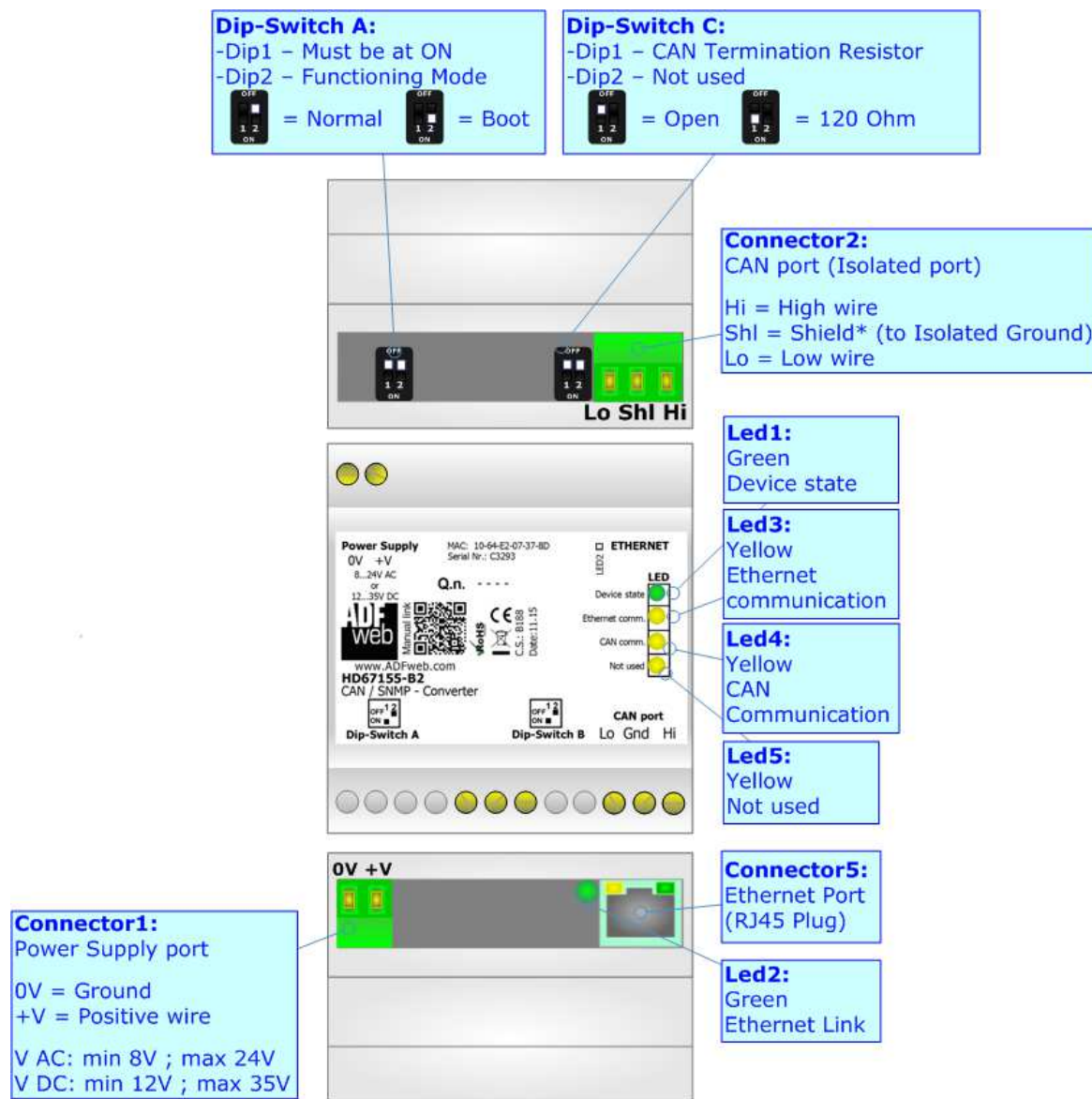

Figure 1b: Connection scheme for HD67155-B2

CHARACTERISTICS:

The HD67155-A1 and HD67155-B2 is a CAN / SNMP Agent - Converter.

It has the following characteristics:

- Up to 1024 bytes in reading and 1024 bytes in writing;
- Triple isolation between CAN - Power Supply, CAN - Ethernet, Power Supply - Ethernet.
- Two-directional information between CAN bus and SNMP bus;
- Mountable on 35mm Rail DIN;
- Wide power supply input range: 8...24V AC or 12...35V DC;
- Wide temperature range: -40°C / 85°C [-40°F / +185°F].

CONFIGURATION:

You need Compositor SW67155 software on your PC in order to perform the following:

- Define the parameter of SNMP line;
- Define the parameter of CAN line;
- Define the CAN frames that the converter can accept;
- Define the CAN frames that the converter sends through the CAN line;
- Define the map of CAN byte that must be written in the SNMP array;
- Define the map of which SNMP bytes must be written in CAN frames;
- Update the device.

POWER SUPPLY:

The devices can be powered at 8...24V AC and 12...35V DC. For more details see the two tables below.

VAC		VDC	
Vmin	Vmax	Vmin	Vmax
8V	24V	12V	35V

Consumption at 24V DC:

Device	Consumption [W/VA]
HD67155-A1	3.5
HD67155-B2	3.5

Connector1:
Power Supply port
0V = Ground
+V = Positive wire
V AC: min 8V ; max 24V
V DC: min 12V ; max 35V

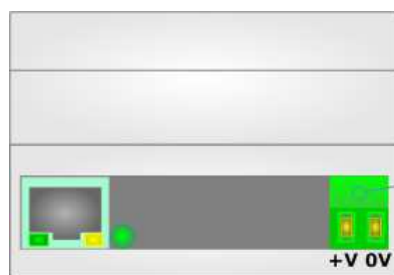

Connector1:
Power Supply port
0V = Ground
+V = Positive wire
V AC: min 8V ; max 24V
V DC: min 12V ; max 35V

Caution: Not reverse the polarity power

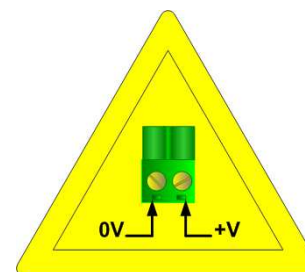

HD67155-A1

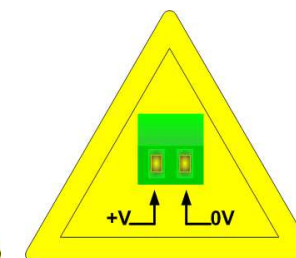

HD67155-B2

FUNCTION MODES:

The device has got two functions mode depending of the position of the 'Dip2 of Dip-Switch A':

- The first, with 'Dip2 of Dip-Switch A' at "OFF" position, is used for the normal working of the device.
- The second, with 'Dip2 of Dip-Switch A' at "ON" position, is used for upload the Project and/or Firmware.

For the operations to follow for the updating, see 'UPDATE DEVICE' section.

According to the functioning mode, the LEDs will have specifics functions, see 'LEDS' section.

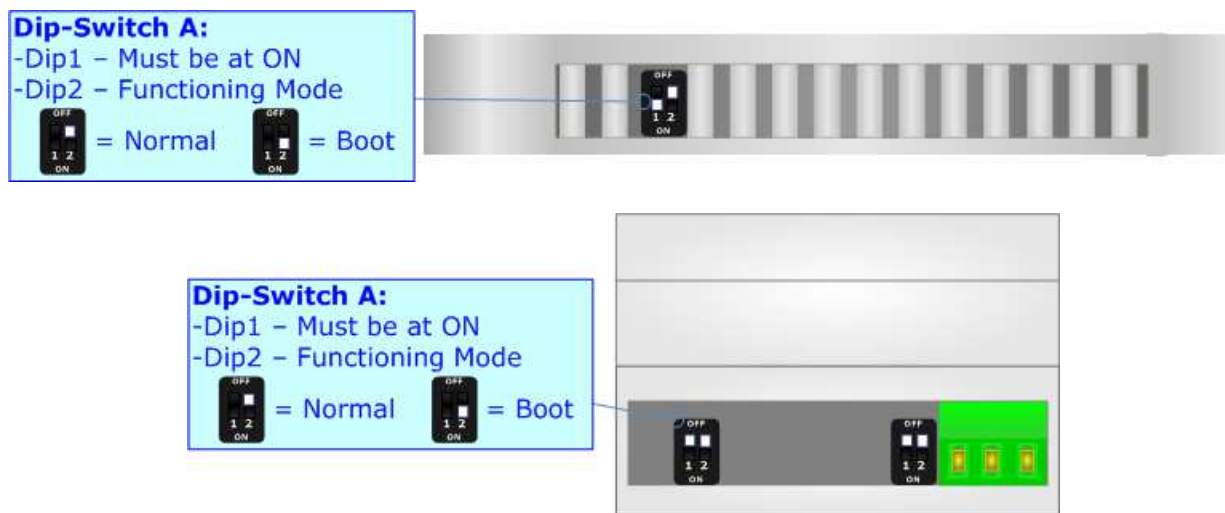
**Warning:**

Dip1 of 'Dip-Switch A' must be at ON position for working even if the Ethernet cable isn't inserted.

LEDS:

The devices has got four (five for HD67155-B2) LEDs that are used to give information of the functioning status. The various meanings of the LEDs are described in the table below.

LED	Normal Mode	Boot Mode
1: Device State	Blinks slowly (~1Hz)	Blinks quickly: Boot state Blinks very slowly (~0.5Hz): update in progress
2: Ethernet Link	ON: Ethernet cable connected OFF: Ethernet cable disconnected	ON: Ethernet cable connected OFF: Ethernet cable disconnected
3: Ethernet Communication	Blinks when SNMP frames are received	Blinks quickly: Boot state Blinks very slowly (~0.5Hz): update in progress
4: CAN Communication	Blinks when CAN frames are received	Blinks quickly: Boot state Blinks very slowly (~0.5Hz): update in progress
5: Not used (Present only on HD67155-B2)	OFF	Blinks quickly: Boot state Blinks very slowly (~0.5Hz): update in progress

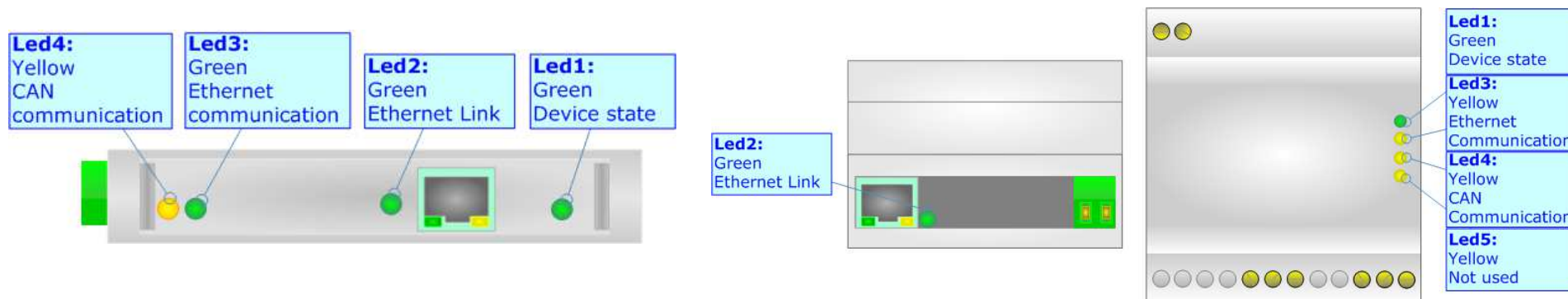

SNMP:

The SNMP connection must be made using Connector5 of HD67155-A1/B2 with at least a Category 5E cable. The maximum length of the cable should not exceed 100m. The cable has to conform to the T568 norms relative to connections in cat.5 up to 100 Mbps. To connect the device to an Hub/Switch is recommended the use of a straight cable, to connect the device to a PC/other is recommended the use of a cross cable.

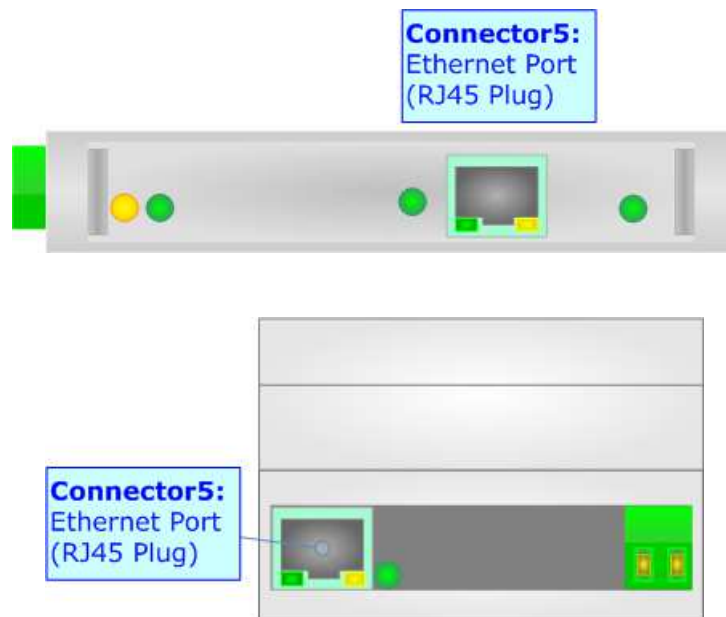

CAN:

For terminate the CAN line with a 120Ω resistor it is necessary that the Dip1 of 'Dip-Switch C' is at ON position.

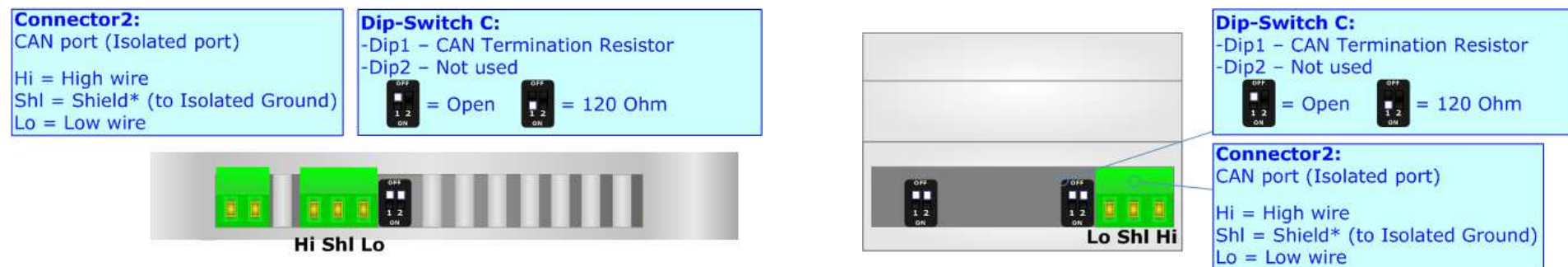

Cable characteristics:

DC parameter:	Impedance	70 Ohm/m
AC parameters:	Impedance	120 Ohm/m
	Delay	5 ns/m
Length	Baud Rate [bps]	Length MAX [m]
	10 K	5000
	20 K	2500
	50 K	1000
	100 K	650
	125 K	500
	250 K	250
	500 K	100
	800 K	50
	1000 K	25

USE OF COMPOSITOR SW67155:

To configure the Converter, use the available software that runs with Windows called SW67155. It is downloadable on the site www.adfweb.com and its operation is described in this document. *(This manual is referenced to the last version of the software present on our web site).* The software works with MSWindows (XP, Vista, Seven, 8, 10; 32/64bit).

When launching the SW67155, the window below appears (Fig. 2).



Note:

It is necessary to have installed .Net Framework 4.

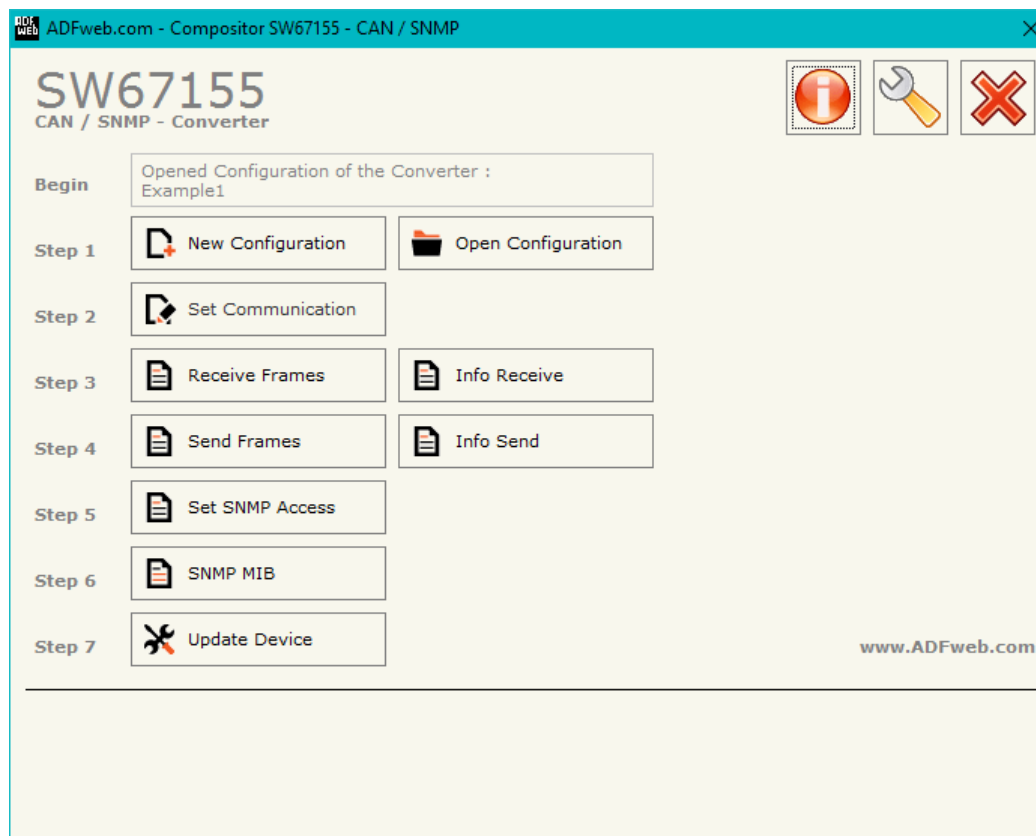
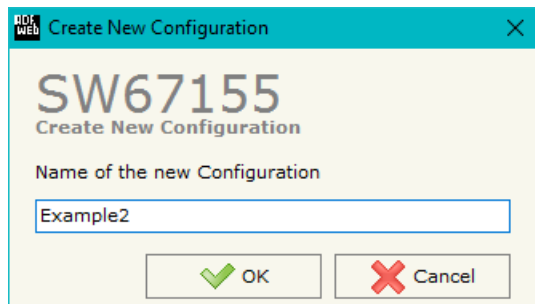

Figure 2: Main window for SW67155

NEW CONFIGURATION / OPEN CONFIGURATION:

The “**New Configuration**” button creates the folder which contains the entire device’s configuration.



A device’s configuration can also be imported or exported:

- To clone the configurations of a Programmable “CAN / SNMP Agent - Converter” in order to configure another device in the same manner, it is necessary to maintain the folder and all its contents;
- To clone a project in order to obtain a different version of the project, it is sufficient to duplicate the project folder with another name and open the new folder with the button “**Open Configuration**”.

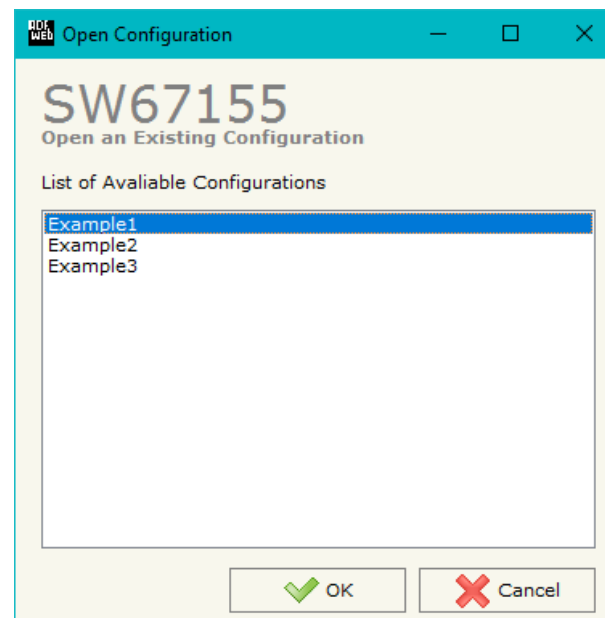

SOFTWARE OPTIONS:

By pressing the “**Settings**” () button there is the possibility to change the language of the software and check the updatings for the compositor.

In the section “Language” it is possible to change the language of the software.

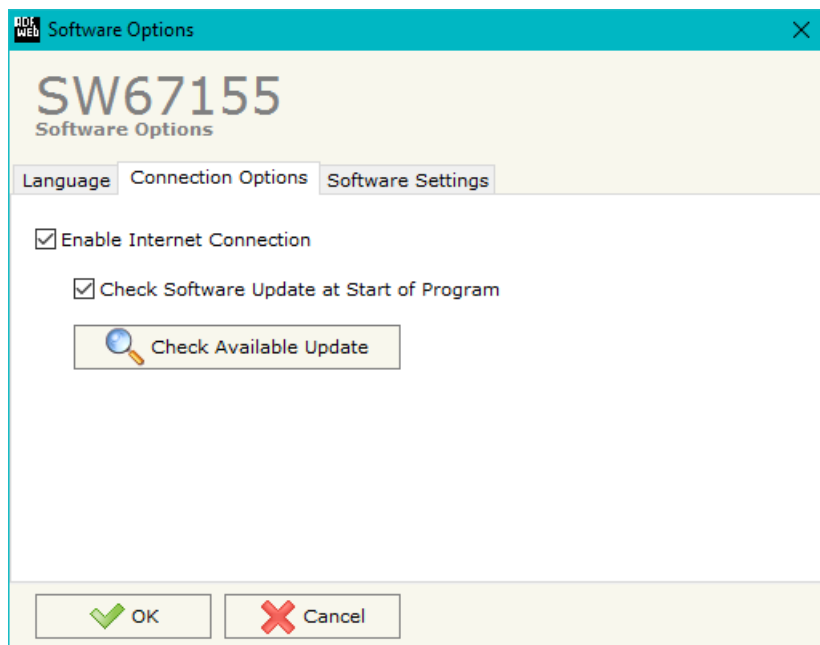

In the section “Connection Options”, it is possible to check if there are some updatings of the software compositor in ADFweb.com website. Checking the option “**Check Software Update at Start of Program**”, the SW67155 check automatically if there are updatings when it is launched.

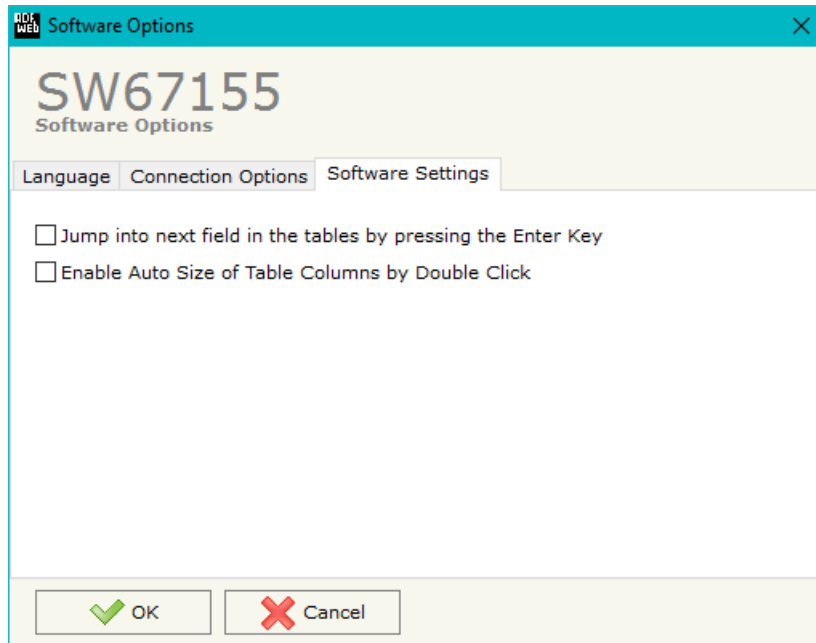

In the section "Software Settings", it is possible to enable/disable some keyboard's commands for an easier navigation inside the tables contained in the different sections of the software.

SET COMMUNICATION:

This section define the fundamental communication parameters of two buses, SNMP and CAN.

By Pressing the **"Set Communication"** button from the main window for SW67155 (Fig. 2) the window "Set Communication" appears (Fig. 3).

The window is divided in two sections, one for the SNMP and the other for the CAN.

The means of the fields for "SNMP" are:

- In the fields **"IP ADDRESS"** the IP address of the converter is defined;
- In the fields **"SUBNET Mask"** the SubNet Mask of the converter is defined;
- In the fields **"GATEWAY"** the default gateway of the network is defined. This feature can be enabled or disabled pressing the Check Box field. This feature is used for going out of the net;
- In the field **"Tunneling Port"** the port to use for the "Tunneling mode" is defined (see page 31 for more details);
- In the field **"Send Back CAN messages"** it is possible to enable the transmission of CAN messages in a transparent mode;
- If the option **"Reply on the Tunneling Port"** is checked, the CAN messages are sent to the Tunneling Port (applicable only if the "Send back CAN messages" is enabled);
- In the field **"SNMP Name of Station"** the name for SNMP Agent station is defined;
- In the field **"Contact"** the contact for SNMP Agent station is defined;
- In the field **"Location"** the location for SNMP Agent station is defined.

The means of the fields for the "CAN" section are:

- In the field **"Baudrate"** the CAN baudrate is defined.

The screenshot shows a web-based configuration window titled "Set Communication" for device "SW67155". The window is divided into two main sections: "SNMP" and "CAN".

SNMP Section:

- IP ADDRESS:** 192 . 168 . 0 . 10
- SUBNET Mask:** 255 . 255 . 255 . 0
- GATEWAY:** 192 . 168 . 0 . 1
- Tunnelling Port:** 2000
- Send Back CAN Messages:**
- Replay on the Tunneling Port:**
- SNMP Name of Station:** devicename1
- Contact:** [Empty field]
- Location:** [Empty field]

CAN Section:

- Baudrate:** 1000K

At the bottom of the window, there are two buttons: "OK" (with a green checkmark) and "Cancel" (with a red X).

Figure 3: "Set Communication" window

RECEIVE FRAMES:

By pressing the **Receive Frames** button from the main window for SW67155 (Fig. 2) the "Receive CAN Frames" window appears (Fig. 4). The COB inserted in this table contains the Output data of SNMP. These frames are accepted by the Converter.

N°	Cob-ID	Type	Dimension	TimeOut	Mnemonic
1	0x181	2.0A (11 bits)	8	10000	First CAN Frame
2	0x182	2.0B (29 bits)	5	0	Second CAN Frame
3					
4					
5					

Figure 4: "Receive CAN Frames" window

The data of the columns have the following meanings:

- In the field **"Cob-ID"** the COB-ID of the CAN frame is defined;
- In the field **"Type"** the type of CAN message is defined (2.0A (11 bits) or 2.0B (29 bits));
- In the field **"Dimension"** the number of data bytes of the message (from 1 to 8) is defined;
- In the field **"TimeOut"** the time (in ms) of the timeout of the data is defined. If a CAN frame is not received in this time, all the data of the CAN frame will be set to zero. It is possible to disable this function by setting this field to '0';
- In the field **"Mnemonic"** a brief description is defined.

INFO RECEIVE:

By pressing the "Info Receive" button from the main window for SW67155 (Fig. 2) the "Receive CAN Frames Info" window appears (Fig. 5):

- In the column "COB ID" there are the COB-IDs listed in the "Receive Frames" section;
- In the fields "Bytes" the bytes of the internal array of the converter where mapping the data from CAN are defined.

Receive CAN Frames Info

SW67155
Receive CAN Frames Info

COB ID	Bytes
0x181	Byte 1 of frame CAN go to byte <input type="text" value="0"/> of SNMP
0x182	Byte 2 of frame CAN go to byte <input type="text" value="1"/> of SNMP
	Byte 3 of frame CAN go to byte <input type="text" value="2"/> of SNMP
	Byte 4 of frame CAN go to byte <input type="text" value="3"/> of SNMP
	Byte 5 of frame CAN go to byte <input type="text" value="4"/> of SNMP
	Byte 6 of frame CAN go to byte <input type="text" value="5"/> of SNMP
	Byte 7 of frame CAN go to byte <input type="text" value="6"/> of SNMP
	Byte 8 of frame CAN go to byte <input type="text" value="7"/> of SNMP

OK Cancel

Figure 5: "Receive CAN Frames Info" window

SEND FRAMES:

By pressing the **Send Frames** button from the main window for SW67155 (Fig. 2) the "Send CAN frames" window appears (Fig. 6). The COB inserted in this table contains the Input data of SNMP. These frames are sent by the Converter.

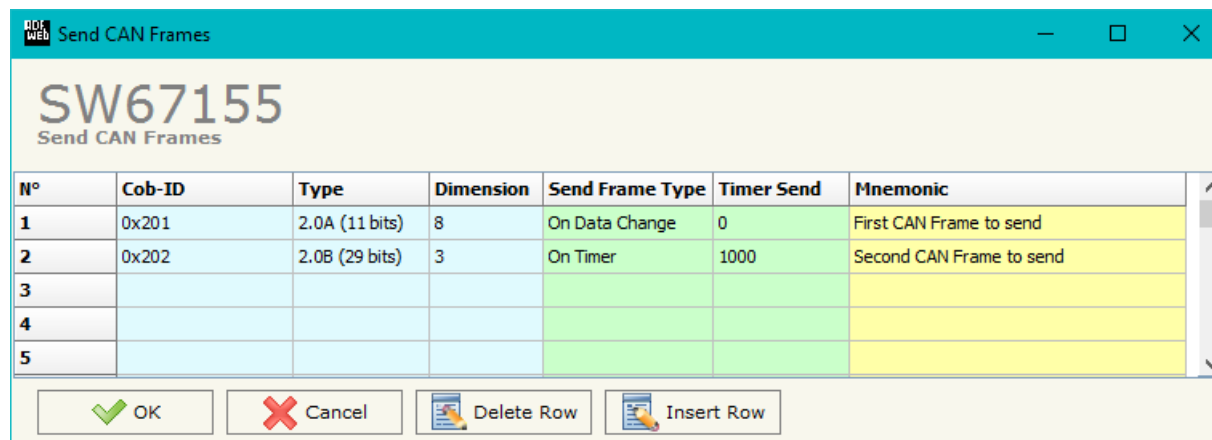

N°	Cob-ID	Type	Dimension	Send Frame Type	Timer Send	Mnemonic
1	0x201	2.0A (11 bits)	8	On Data Change	0	First CAN Frame to send
2	0x202	2.0B (29 bits)	3	On Timer	1000	Second CAN Frame to send
3						
4						
5						

Figure 6: "Send CAN Frames" window

The data of the columns have the following meanings:

- In the field **Cob-ID** the COB-ID of the CAN frame is defined;
- In the field **Type** the type of CAN message sent is defined ('2.0A (11bits)' or '2.0B (29bits)');
- In the field **Dimension** the number of bytes of the CAN frame (from 1 to 8) is defined;
- In the field **Send Frame Type** the transmission type of the CAN frame is defined. There are two options:
 - **On Data Change**: the frame is sent when the data changes;
 - **On Times**: the frame is sent cyclically;
- In the field **Timer Send** the delay (in ms) between two CAN frames is defined (if the option **On Timer** is checked);
- In the field **Mnemonic** a brief description is defined.

INFO SEND:

By pressing the "Info Send" button from the main window for SW67155 (Fig. 2) the "Send CAN Frames Info" window appears (Fig. 7):

- In the column "COB ID" there are the COB-IDs listed in the "Send Frames" section;
- In the fields "Bytes" the bytes of the internal array of the converter where taking the data to send on CAN are defined.

Send CAN Frames Info

SW67155
Send CAN Frames Info

COB ID	Bytes
0x201	Byte 1 of frame CAN go to byte <input type="text" value="0"/> of SNMP
0x202	Byte 2 of frame CAN go to byte <input type="text" value="1"/> of SNMP
	Byte 3 of frame CAN go to byte <input type="text" value="2"/> of SNMP
	Byte 4 of frame CAN go to byte <input type="text" value="3"/> of SNMP
	Byte 5 of frame CAN go to byte <input type="text" value="4"/> of SNMP
	Byte 6 of frame CAN go to byte <input type="text" value="5"/> of SNMP
	Byte 7 of frame CAN go to byte <input type="text" value="6"/> of SNMP
	Byte 8 of frame CAN go to byte <input type="text" value="7"/> of SNMP

Figure 7: "Send Frames Info" window

SET SNMP ACCESS:

By pressing the “**Set SNMP Access**” button from the main window for SW67155 (Fig. 2) the “Set SNMP Trap Access” window appears (Fig. 8). In this section, it is possible to create the OIDs for SNMP side to read or write using GET and SET commands or to be sent as TRAP messages. The window is divided into two tables, one for SNMP readings and one for SNMP writings.

The data of the columns in the “SNMP Read” have the following meanings:

- If the field “**Enable**” is checked, the SNMP OID is enabled;
- In the field “**Community Name**” the name of the Community is defined;
- In the field “**Type**” the type of data of the OID is defined (Octet String or Integer);
- If the field “**On Change**” is checked, the OID is sent as Trap when the data from CAN side change;
- If the field “**On CMD**” is checked, the OID is sent as Trap when a new CAN message is received;
- If the field “**On Timer**” is checked, the OID is sent as Trap cyclically;
- In the field “**Time (ms)**” the delay time for the Trap send is defined (if “On Timer” option is checked);
- In the field “**Position**” the starting byte of the internal memory array where taking the data is defined;
- In the field “**Start Bit**” the starting bit of the selected Position is defined;
- In the field “**Num Bits/Bytes**” the dimension of the OID is defined. For ‘Int’ type the dimension is in bit, for ‘String’ type the dimension is in bytes;
- In the field “**Description**” the description/name of the OID is defined;
- In the field “**IP Address**” the IP Address of the SNMP device where addressing the Trap message is defined. This field is used only when ‘On Change’ or ‘On CMD’ or ‘On Timer’ option is checked;
- In the field “**Mnemonic**” a brief description of the OID is defined.



Figure 8a: “Set SNMP Access -> SNMP Read” window

The data of the columns in the "SNMP Write" have the following meanings:

- If the field "Enable" is checked, the SNMP OID is enabled;
- In the field "Community Name" the name of the Community is defined;
- In the field "Type" the type of data of the OID is defined (Octet String or Integer);
- In the field "Position" the starting byte of the internal memory array where mapping the data is defined;
- In the field "Start Bit" the starting bit of the selected Position is defined;
- In the field "Num Bits/Bytes" the dimension of the OID is defined. For 'Int' type the dimension is in bit, for 'String' type the dimension is in bytes;
- In the field "Description" the description/name of the OID is defined;
- In the field "Mnemonic" a brief description of the OID is defined.

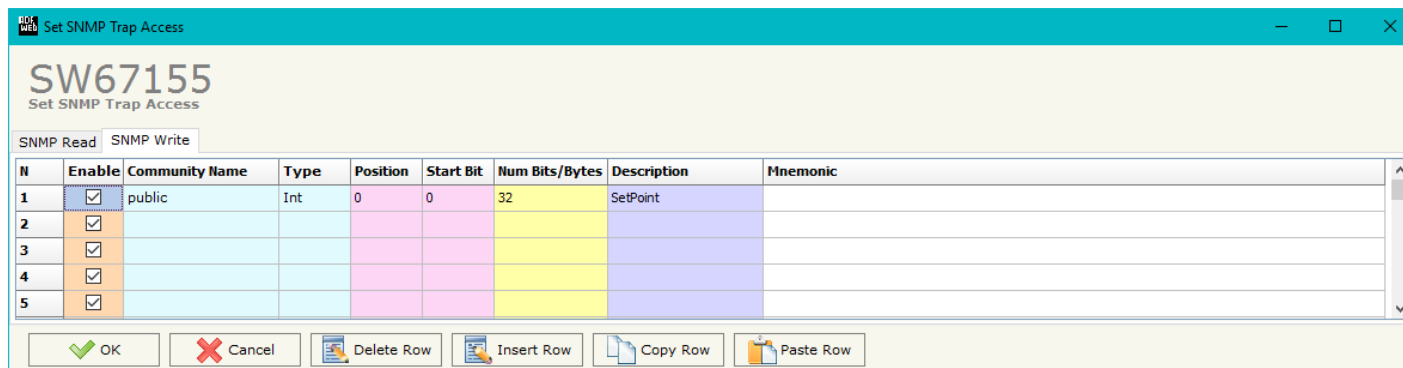

Figure 8b: "Set SNMP Access -> SNMP Write" window

Note: If the fields "On Change", "On CMD" and "On Timer" are disabled, the OID is readable using standard GET command. If one of these fields is enabled, the OID is sent as Trap and it is readable by GET command too.

Note: The field "Description" must start with lowercase letter and it cannot contain special chars (just letters and numbers). All the "Description" fields must be different between them.

SNMP MIB:

By pressing the "SNMP MIB" button it is possible to save the MIB file for the SNMP Manager.

UPDATE DEVICE:

By pressing the “**Update Device**” button, it is possible to load the created Configuration into the device; and also the Firmware, if necessary.

If you don't know the actual IP address of the device you have to use this procedure:

- Turn OFF the Device;
- Put Dip1 of 'Dip-Switch A' in ON position;
- Turn on the device
- Connect the Ethernet cable;
- Insert the IP “**192.168.2.205**”;
- Press the “**Ping**” button, “Device Found!” must appear;
- Press the “**Next**” button;
- Select which operations you want to do;
- Press the “**Execute update firmware**” button to start the upload;
- When all the operations are “OK” turn off the Device;
- Put Dip1 of 'Dip-Switch A' at OFF position;
- Turn ON the device.

If you know the actual IP address of the device, you have to use this procedure:

- Turn on the Device with the Ethernet cable inserted;
- Insert the actual IP of the Converter;
- Press the “**Ping**” button, must appear “Device Found!”;
- Press the “**Next**” button;
- Select which operations you want to do;
- Press the “**Execute update firmware**” button to start the upload;
- When all the operations are “OK” the device automatically goes at Normal Mode.

At this point the configuration/firmware on the device is correctly update.

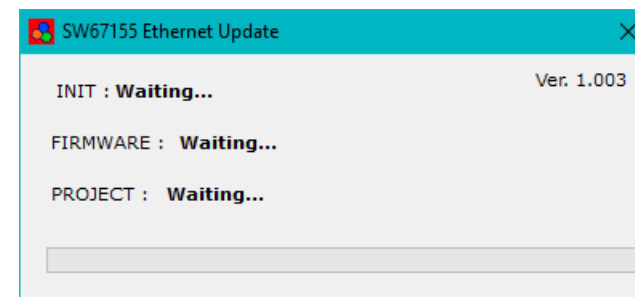
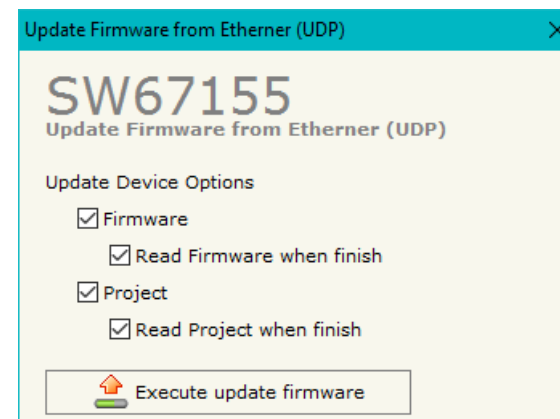
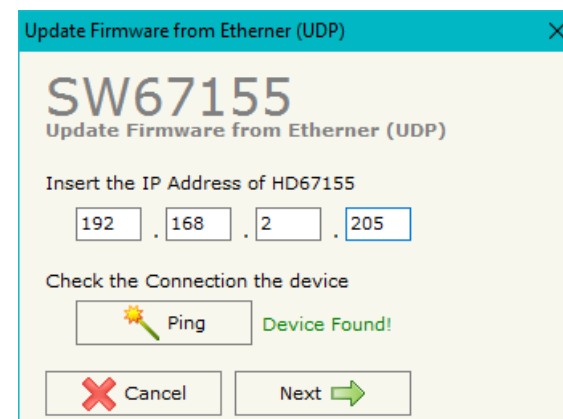





Figure 9: “Update device” windows

 **Note:**
When you install a new version of the software, if it is the first time it is better you do the update of the Firmware in the HD67155-A1/B2 device.

 **Note:**
When you receive the device, for the first time, you also have to update the Firmware in the HD67155-A1/B2 device.

 **Warning:**
If Fig. 10 appears when you try to do the Update try these points before seeking assistance:

- Try to repeat the operations for the updating;
- Try with another PC;
- Try to restart the PC;
- Check the LAN settings;
- If you are using the program inside a Virtual Machine, try to use in the main Operating System;
- If you are using Windows Seven, Vista, 8 or 10 make sure that you have the administrator privileges;
- In case you have to program more than one device, using the "UDP Update", you have to cancel the ARP table every time you connect a new device on Ethernet. For do this you have to launch the "Command Prompt" and write the command "arp -d". Pay attention that with Windows Vista, Seven, 8 or 10 you have to launch the "Command Prompt" with Administrator Rights;
- Pay attention at Firewall lock.

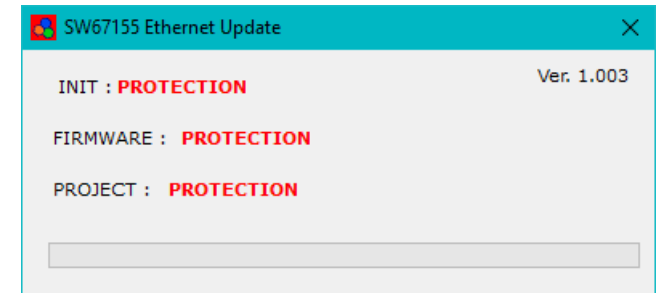



Figure 10: "Protection" window

 In the case of HD67155-A1/B2 you have to use the software "SW67155": www.adfweb.com/download/filefold/SW67155.zip.

SNMP COMMUNICATION

In order to read/write the data from/to CAN side, it is necessary to use specific SNMP commands in order to see the SNMP Input and write the SNMP Output.

Reading CAN data from SNMP:

In order to read the data from the HD67155-A1/B2, it is necessary to use the GET command.
Each OID defined in the section "Set SNMP Access -> SNMP Read" will be placed in the MIB tree of the converter.

In addition, it will be possible to read the entire internal map of the converter in memory blocks of 128 bytes: this feature is helpful in phase of configuration of the converter.

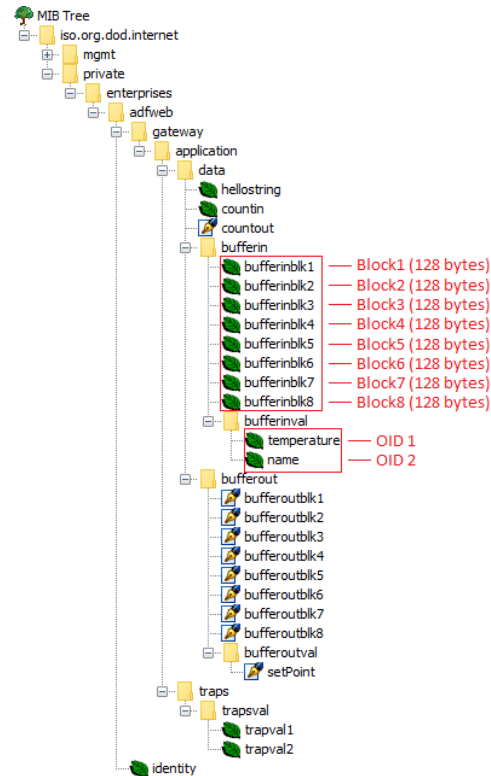

Each SNMP variable created will have its own OID and it will be created following this rule:

- OID 1 (first row of "Set SNMP Access -> SNMP Read" table): **.1.3.6.1.4.1.49314.1.1.1.4.9.1**
- OID 2 (second row of "Set SNMP Access -> SNMP Read" table): **.1.3.6.1.4.1.49314.1.1.1.4.9.2**
- OID X (Xth row of "Set SNMP Access -> SNMP Read" table): **.1.3.6.1.4.1.49314.1.1.1.4.9.X**

The memory blocks are accessible with these OIDs:

- Block1: .1.3.6.1.4.1.49314.1.1.1.4.1.0
- Block2: .1.3.6.1.4.1.49314.1.1.1.4.2.0
- Block3: .1.3.6.1.4.1.49314.1.1.1.4.3.0
- Block4: .1.3.6.1.4.1.49314.1.1.1.4.4.0
- Block5: .1.3.6.1.4.1.49314.1.1.1.4.5.0
- Block6: .1.3.6.1.4.1.49314.1.1.1.4.6.0
- Block7: .1.3.6.1.4.1.49314.1.1.1.4.7.0
- Block8: .1.3.6.1.4.1.49314.1.1.1.4.8.0

Writing CAN data from SNMP:

In order to write the data from the HD67155-A1/B2, it is necessary to use the SET command.
 Each OID defined in the section "Set SNMP Access -> SNMP Write" will be placed in the MIB tree of the converter.

In addition, it will be possible to write the entire internal map of the converter in memory blocks of 128 bytes: this feature is helpful in phase of configuration of the converter.

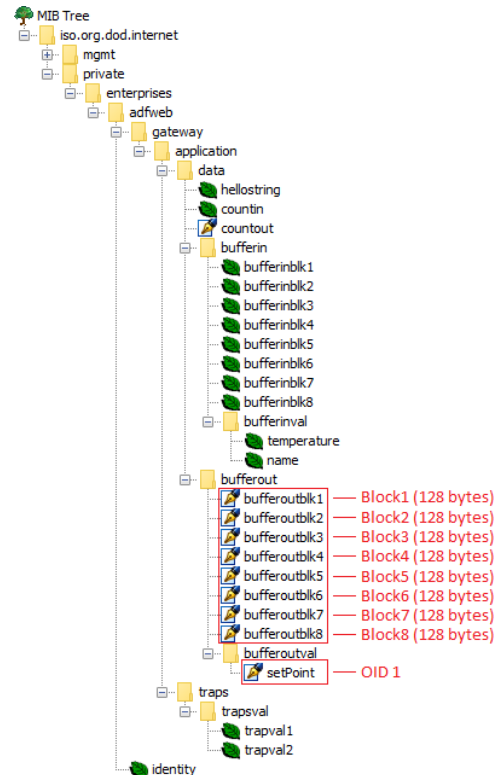

Each SNMP variable created will have its own OID and it will be created following this rule:

- ➔ OID 1 (first row of "Set SNMP Access -> SNMP Write" table): **.1.3.6.1.4.1.49314.1.1.1.5.9.1**
- ➔ OID 2 (second row of "Set SNMP Access -> SNMP Write" table): **.1.3.6.1.4.1.49314.1.1.1.5.9.2**
- ➔ OID X (Xth row of "Set SNMP Access -> SNMP Write" table): **.1.3.6.1.4.1.49314.1.1.1.5.9.X**

The memory blocks are accessible with these OIDs:

- ➔ Block1: .1.3.6.1.4.1.49314.1.1.1.5.1.0
- ➔ Block2: .1.3.6.1.4.1.49314.1.1.1.5.2.0
- ➔ Block3: .1.3.6.1.4.1.49314.1.1.1.5.3.0
- ➔ Block4: .1.3.6.1.4.1.49314.1.1.1.5.4.0
- ➔ Block5: .1.3.6.1.4.1.49314.1.1.1.5.5.0
- ➔ Block6: .1.3.6.1.4.1.49314.1.1.1.5.6.0
- ➔ Block7: .1.3.6.1.4.1.49314.1.1.1.5.7.0
- ➔ Block8: .1.3.6.1.4.1.49314.1.1.1.5.8.0



Note:

The OIDs in writing are readable too with GET command.

TRAP messages from SNMP:

All the OIDs defined in the "Set SNMP Access -> SNMP Read" table can be sent as TRAP messages too.

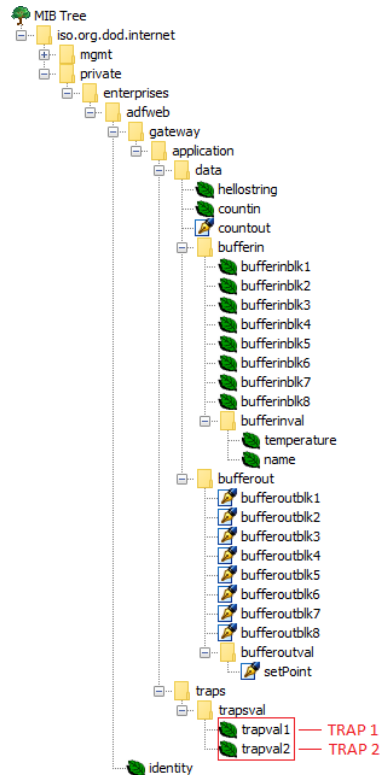

The TRAP messages are contained in the MIB tree and they have these OIDs:

- TRAP 1 (first row of "Set SNMP Access -> SNMP Read" table): .1.3.6.1.4.1.49314.1.1.2.1.1
- TRAP 2 (second row of "Set SNMP Access -> SNMP Read" table): .1.3.6.1.4.1.49314.1.1.2.1.2
- TRAP X (Xth row of "Set SNMP Access -> SNMP Read" table): .1.3.6.1.4.1.49314.1.1.2.1.X

SENDING ASYNCHRONOUS CAN MESSAGES FROM ETHERNET

The converter allows to send asynchronous CAN messages directly from Ethernet to CAN.
The Ethernet message to send to the converter must have this structure:

Byte Number	Description
1÷4	COB-ID of the CAN message to send
5÷(4+n)	Data of the CAN message

n=Number of Byte to Write

To choose the type of CAN (2.0A or 2.0B) of the frame that the converter will send, it is necessary to put the most significant bit of the byte 1 to:

- 0: CAN 2.0A;
- 1: CAN 2.0B.

To send a CAN message from Ethernet to CAN, it is necessary to send the UDP message to the tunneling port of the converter.

Example:

We want to send the CAN message with these characteristics:
CAN Type=2.0A; Frame: Cob_ID=0x0000; Data=0x0105.

So the string of hexadecimal numbers to be send to the converter is: [00][00][00][00][01][05].



Note:

After sending the first CAN messages, if the "Send back CAN messages" option is activated, the CAN messages are sent via Ethernet (UDP messages) with the same structure.

If the option "Send Back CAN messages" is not activated, it is possible to enable/disable it by sending the following UDP messages to the Tunneling Port:

Byte 0	Byte 1
0xB3	Enabling/disabling the Transparent Mode

0x01 = Function disabled

0x00 = Function enabled

If the command message is received correctly, the same message is sent back from the converter.

MECHANICAL DIMENSIONS:

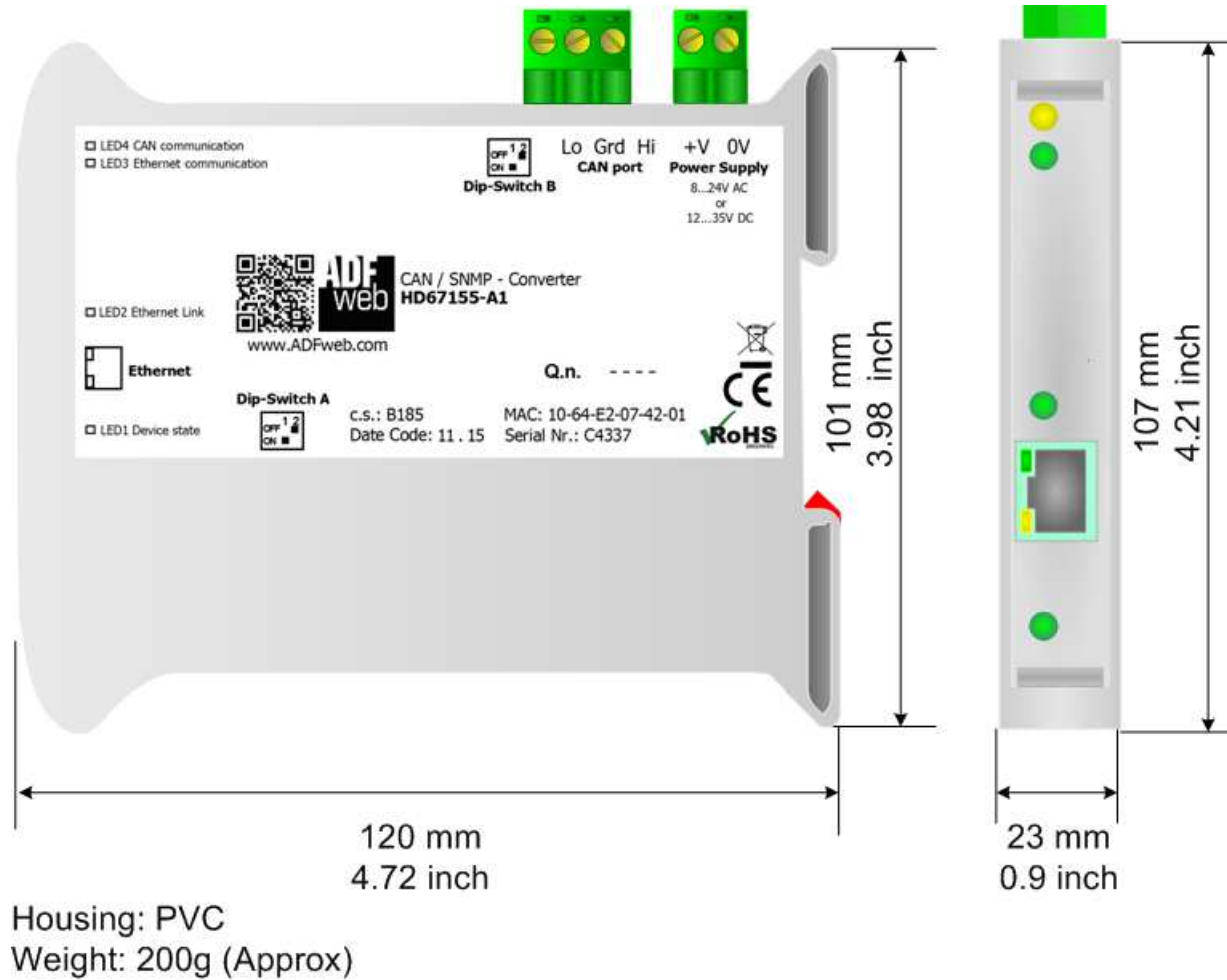
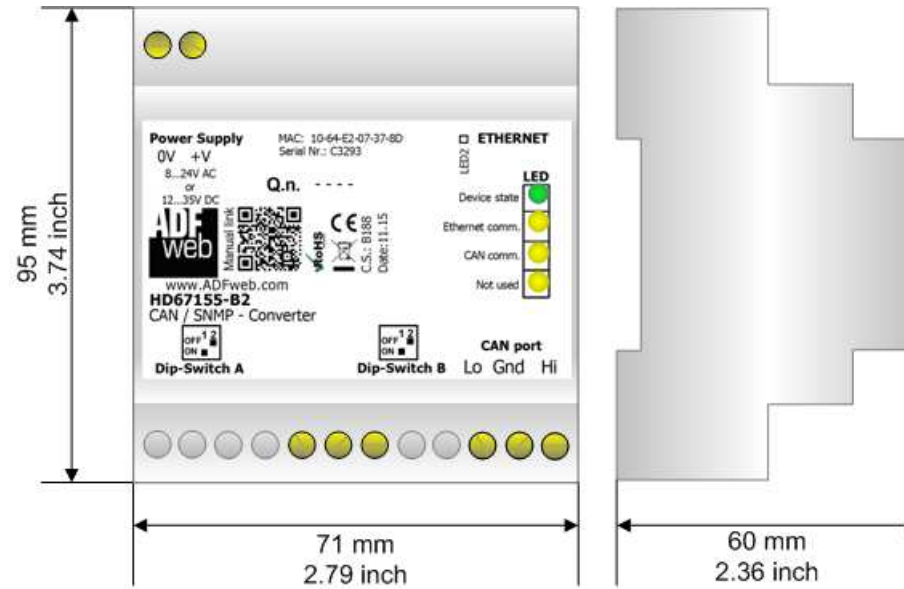

Figure 11a: Mechanical dimensions scheme for HD67155-A1



Housing: PVC
Weight: 200g (Approx)

Figure 11b: Mechanical dimensions scheme for HD67155-B2

ORDERING INFORMATIONS:

The ordering part number is formed by a valid combination of the following:

HD67155 - x x

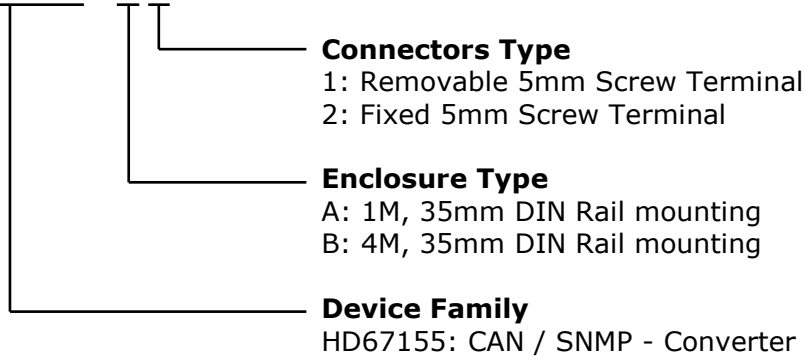

Order Code: **HD67155-A1** - CAN / SNMP – Converter (Housing type: A, Terminal Blocks Connectors)

Order Code: **HD67155-B2** - CAN / SNMP – Converter (Housing type: B, Terminal Blocks Connectors)

ACCESSORIES:

Order Code: **AC34001** - 35mm Rail DIN - Power Supply 220/240V AC 50/60Hz – 12 V AC

Order Code: **AC34002** - 35mm Rail DIN - Power Supply 110V AC 50/60Hz – 12 V AC

DISCLAIMER:

All technical content within this document can be modified without notice. The content of the document is a under continual renewal. For losses due to fire, earthquake, third party access or other accidents, or intentional or accidental abuse, misuse, or use under abnormal conditions repairs are charged to the user. ADFweb.com S.r.l. will not be liable for accidental loss of use or inability to use this product, such as loss of business income. ADFweb.com S.r.l. shall not be liable for consequences of improper use.

OTHER REGULATIONS AND STANDARDS:**WEEE INFORMATION**

Disposal of old electrical and electronic equipment (as in the European Union and other European countries with separate collection systems).

— This symbol on the product or on its packaging indicates that this product may not be treated as household rubbish. Instead, it should be taken to an applicable collection point for the recycling of electrical and electronic equipment. If the product is disposed correctly, you will help prevent potential negative environmental factors and impact of human health, which could otherwise be caused by inappropriate disposal. The recycling of materials will help to conserve natural resources. For more information about recycling this product, please contact your local city office, your household waste disposal service or the shop where you purchased the product.

RESTRICTION OF HAZARDOUS SUBSTANCES DIRECTIVE

The device respects the 2002/95/EC Directive on the restriction of the use of certain hazardous substances in electrical and electronic equipment (commonly referred to as Restriction of Hazardous Substances Directive or RoHS).

CE MARKING

The product conforms with the essential requirements of the applicable EC directives.

WARRANTIES AND TECHNICAL SUPPORT:

For fast and easy technical support for your ADFweb.com SRL products, consult our internet support at www.adfweb.com.
Otherwise contact us at the address support@adfweb.com

RETURN POLICY:

If while using your product you have any problem and you wish to exchange or repair it, please do the following:

- Obtain a Product Return Number (PRN) from our internet support at www.adfweb.com. Together with the request, you need to provide detailed information about the problem.
- Send the product to the address provided with the PRN, having prepaid the shipping costs (shipment costs billed to us will not be accepted).

If the product is within the warranty of twelve months, it will be repaired or exchanged and returned within three weeks. If the product is no longer under warranty, you will receive a repair estimate.



ADFweb.com S.r.l.
Via Strada Nuova, 17
IT-31010 Mareno di Piave
TREVISO (Italy)
Phone +39.0438.30.91.31
Fax +39.0438.49.20.99
www.adfweb.com

